



US00D948972S

(12) **United States Design Patent**
Wang

(10) **Patent No.:** **US D948,972 S**
(45) **Date of Patent:** **** Apr. 19, 2022**

(54) **WOODEN RAISED GARDEN BED PLANTER**

(71) Applicant: **Ningbo Lite Network Technology Co., Ltd., Ningbo (CN)**

(72) Inventor: **Ji Wang, Ningbo (CN)**

(**) Term: **15 Years**

(21) Appl. No.: **29/781,050**

(22) Filed: **Apr. 28, 2021**

(51) **LOC (13) Cl.** **08-01**

(52) **U.S. Cl.**
USPC **D8/1**

(58) **Field of Classification Search**
USPC 47/18, 19.1, 33, 39, 65.5, 65.7; D8/1, D8/354
CPC A01G 9/02; A01G 9/023; A01G 9/041; A01G 9/28

See application file for complete search history.

(56) **References Cited**

U.S. PATENT DOCUMENTS

- 112,220 A * 2/1871 Chalmers A01G 9/1423 47/18
- 207,155 A * 8/1878 Bassett A01G 9/28 52/102
- 538,788 A * 5/1895 Moe A01G 9/28 52/102
- 619,352 A * 2/1899 Schaefer A01G 9/28 47/33
- 948,620 A * 2/1910 Wait A01G 9/1423 47/18
- 1,414,593 A * 5/1922 Sklenka A01G 9/20 47/19.1
- 1,761,796 A * 6/1930 Mead A01G 9/20 47/19.1
- 1,876,571 A * 9/1932 Acuff, Jr. A01G 9/00 47/18

- 1,980,239 A * 11/1934 Vetter A01G 9/1423 47/44
- 2,146,784 A * 2/1939 Wilson A01G 9/28 47/33
- 3,024,569 A * 3/1962 Nearing A01G 9/1423 47/18
- D236,569 S * 9/1975 Kramer A01G 9/28 D11/156
- 5,040,328 A * 8/1991 Coon A01G 18/62 47/1.1
- D468,663 S * 1/2003 Fan D11/156

(Continued)

OTHER PUBLICATIONS

Stratco Wood Plastic Composite Elevated Garden Bed—Elevated 48 (L)×32(h)×20 (w)—Beautiful Elevated Planter Kit for Flower and Vegetable Planter. (Dec. 12, 2018). Amazon.Com. Retrieved Jan. 19, 2022, URL:<<https://www.amazon.com/Stratco-Plastic-Composite-Elevated-Garden/dp/B07J9RR5TZ/?th=1>> (Year: 2018).*

(Continued)

Primary Examiner — Rachel A. Voorhies

Assistant Examiner — Benjamin D. Wannemacher

(74) *Attorney, Agent, or Firm* — Rumit Ranjit Kanakia

(57) **CLAIM**

I claim the ornamental design for a wooden raised garden bed planter, as shown and described.

DESCRIPTION

FIG. 1 is a Perspective view of a wooden raised garden bed planter showing my new design;
FIG. 2 is Front view thereof;
FIG. 3 is a Back view thereof;
FIG. 4 is a Right-side view thereof;
FIG. 5 is a Left-side view thereof;
FIG. 6 is a Top view thereof; and,
FIG. 7 is a Bottom view thereof.

1 Claim, 7 Drawing Sheets

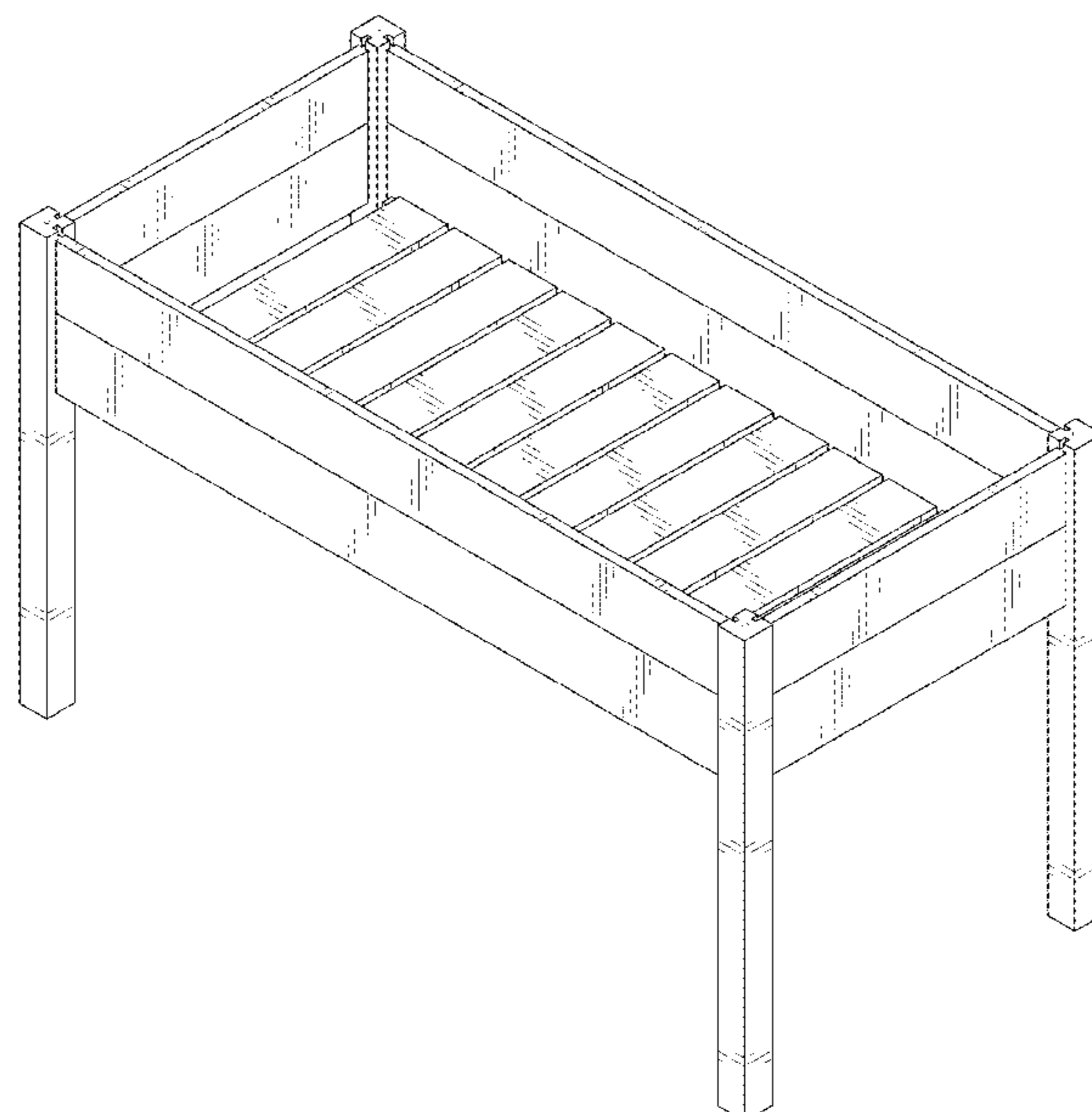

(56)

References Cited

U.S. PATENT DOCUMENTS

D643,647 S * 8/2011 Owen A01G 18/62
D647,767 S * 11/2011 Greenes A01G 9/20
D655,221 S 3/2012 Adams
D676,355 S * 2/2013 Williamsen A01G 9/20
D703,012 S * 4/2014 Yen A01G 9/28
D734,207 S 7/2015 Blouin
D740,717 S 10/2015 Blouin
D842,002 S * 3/2019 Ryan A01G 9/28
D869,329 S 12/2019 Chouikh
D887,797 S 6/2020 Chouikh
2006/0070298 A1* 4/2006 Palsrok A01G 9/022

2010/0186292 A1* 7/2010 Hall A01G 9/28
2010/0242357 A1* 9/2010 Vogler A01G 9/28
2011/0247268 A1* 10/2011 Adams A01G 9/1423
2015/0201563 A1* 7/2015 Chiang A47G 7/041
2020/0221650 A1* 7/2020 Fitzwater A01G 9/28
2020/0253134 A1* 8/2020 Olsen A01G 9/16
2021/0051861 A1* 2/2021 Zhang A01G 9/28
2021/0228002 A1* 7/2021 Gouldstone A47G 7/045

OTHER PUBLICATIONS

Stratco Raised Garden Bed—Assembly. (Feb. 27, 2020). YouTube. Com. Retrieved Jan. 19, 2022, URL:<https://www.youtube.com/watch?v=Hws25bw_Dp0> (Year: 2020).*

* cited by examiner

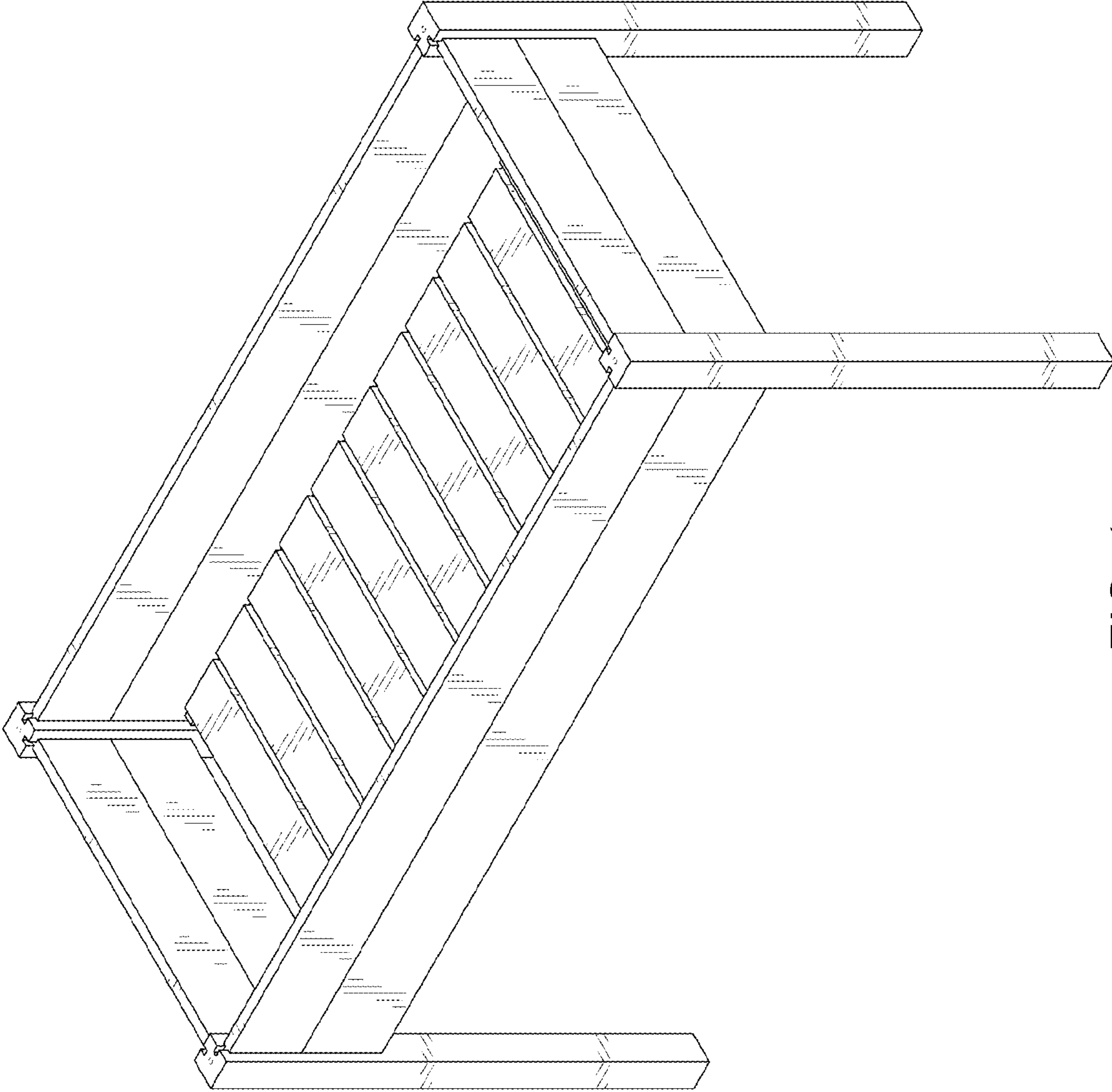

FIG. 1

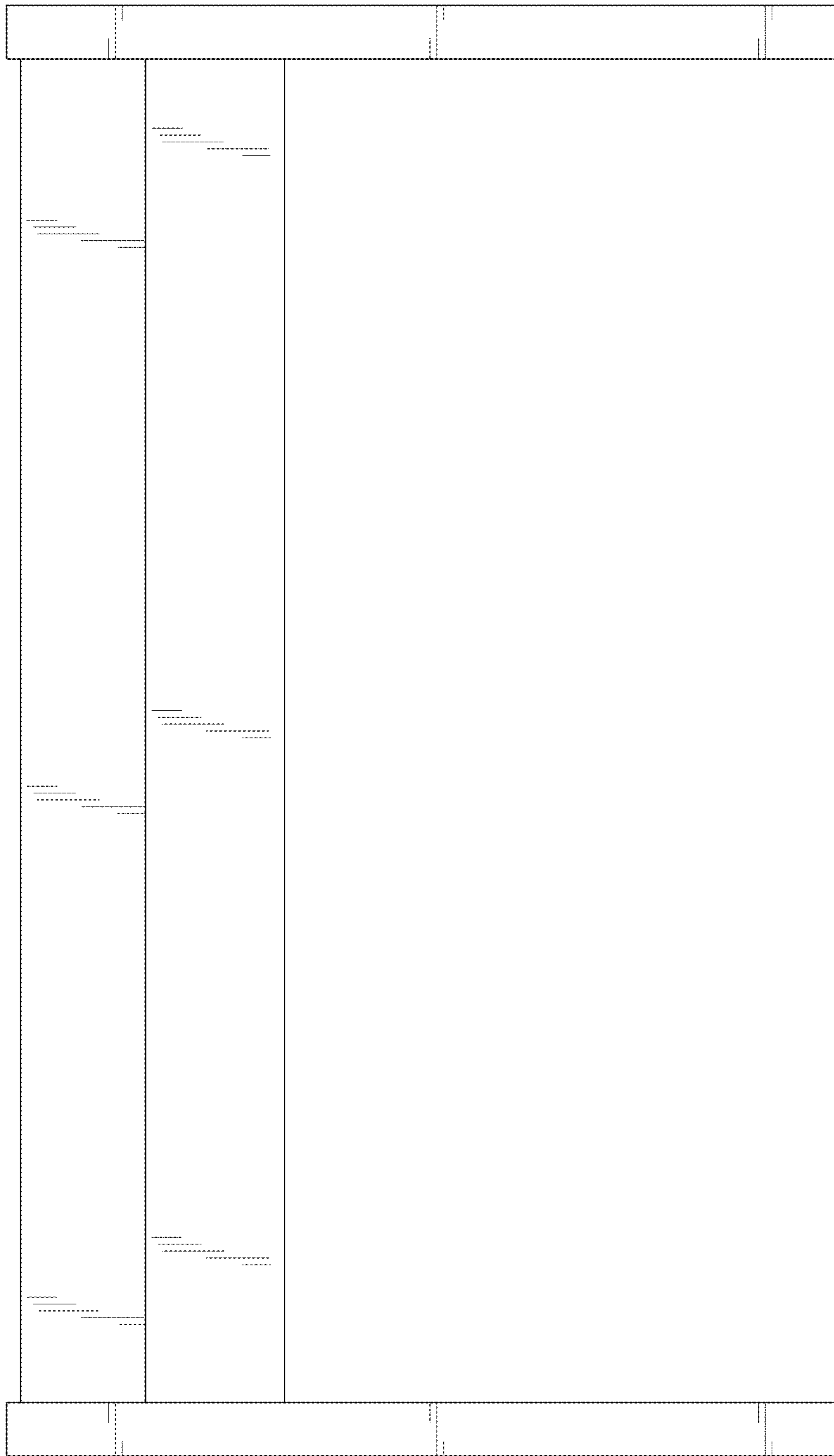

FIG. 2

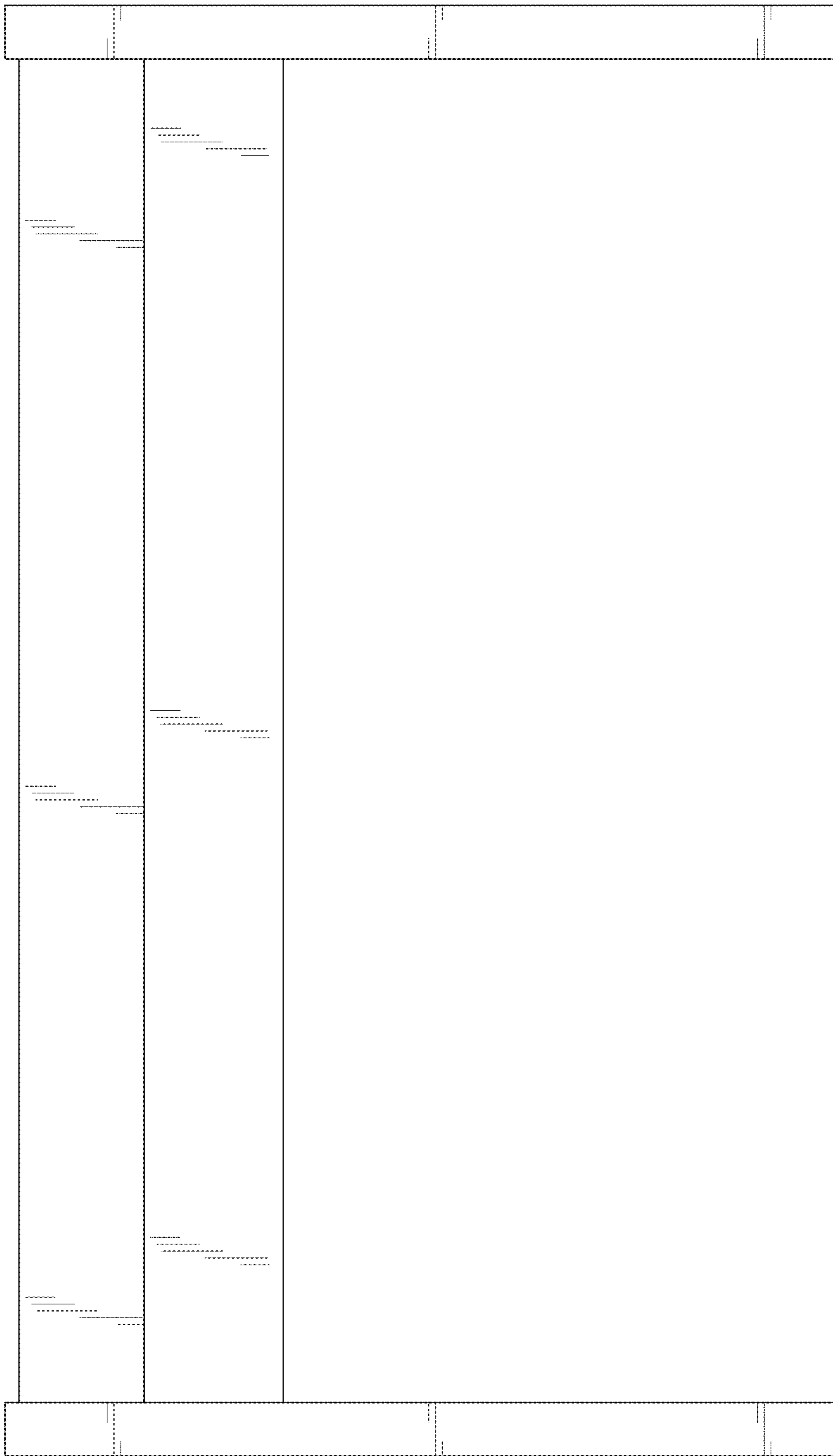

FIG. 3

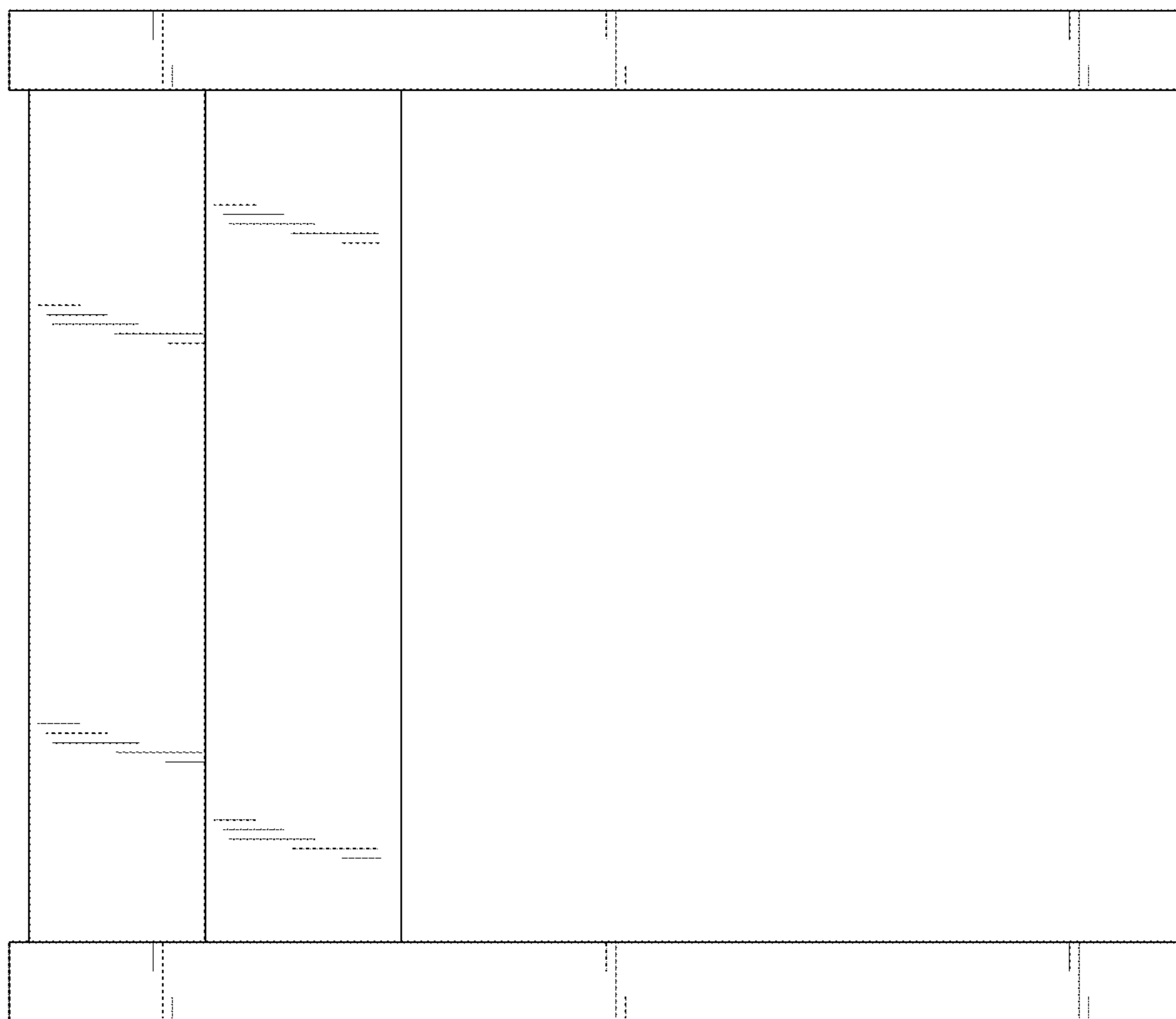

FIG. 4

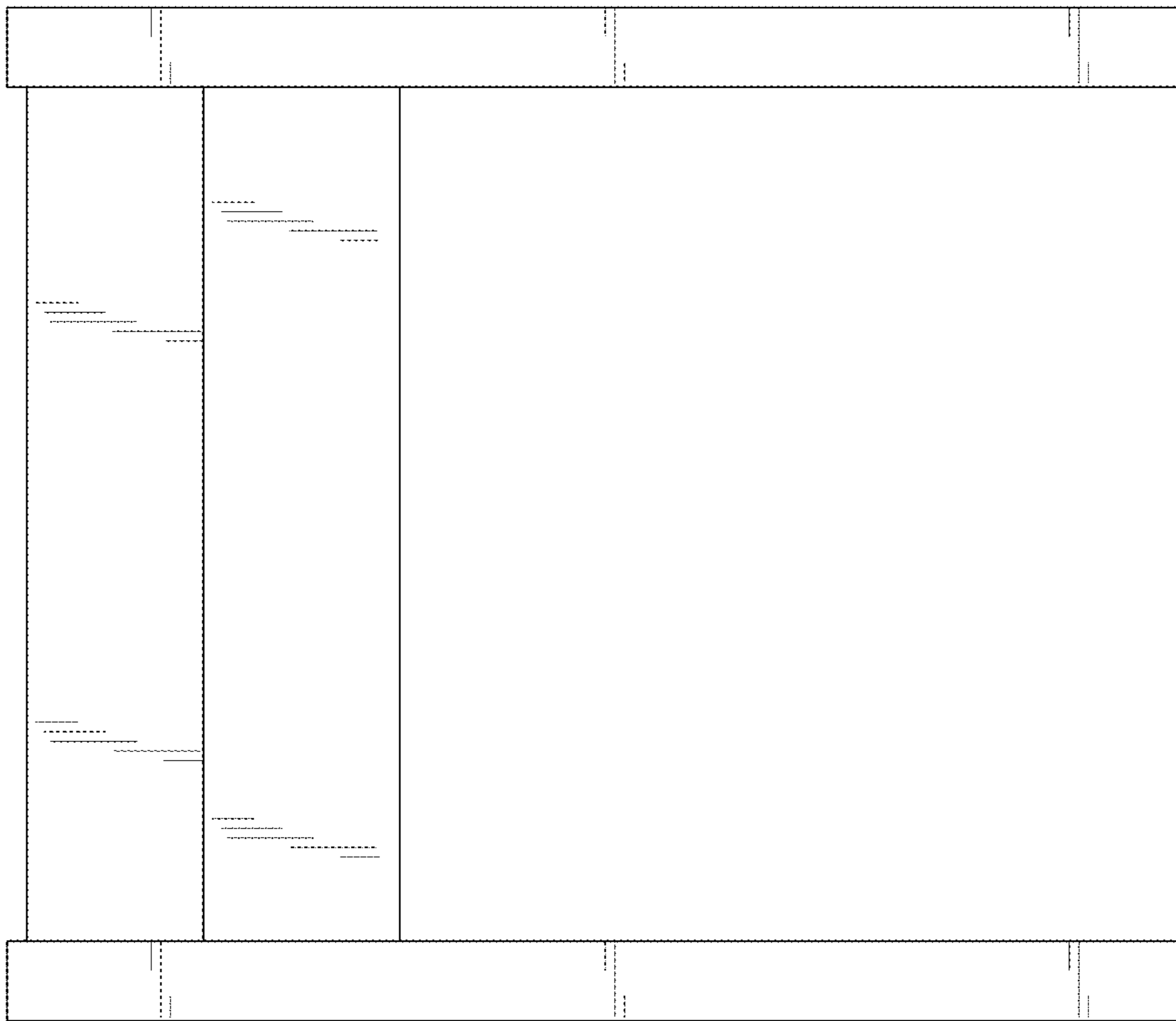

FIG. 5

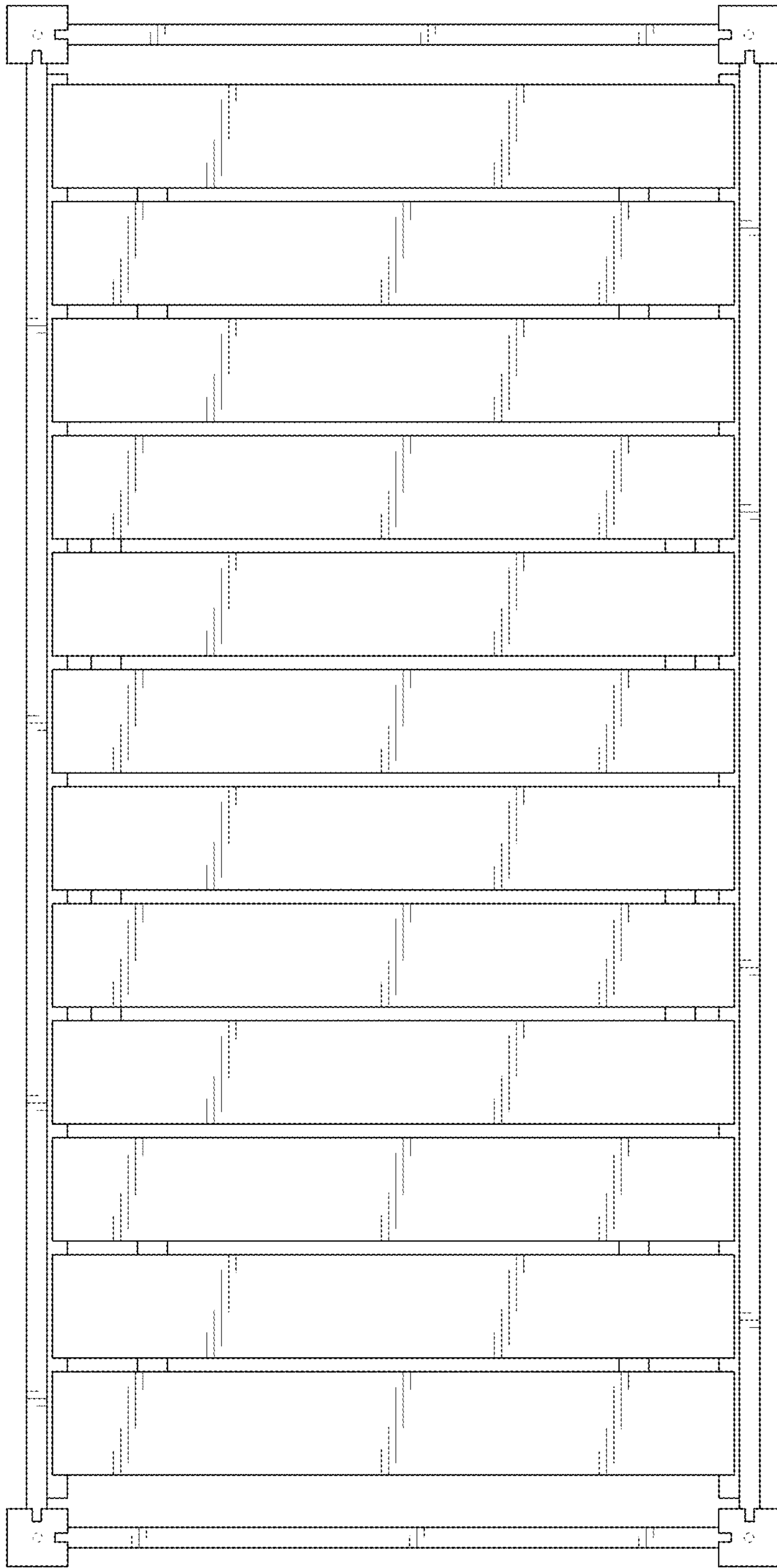

FIG. 6

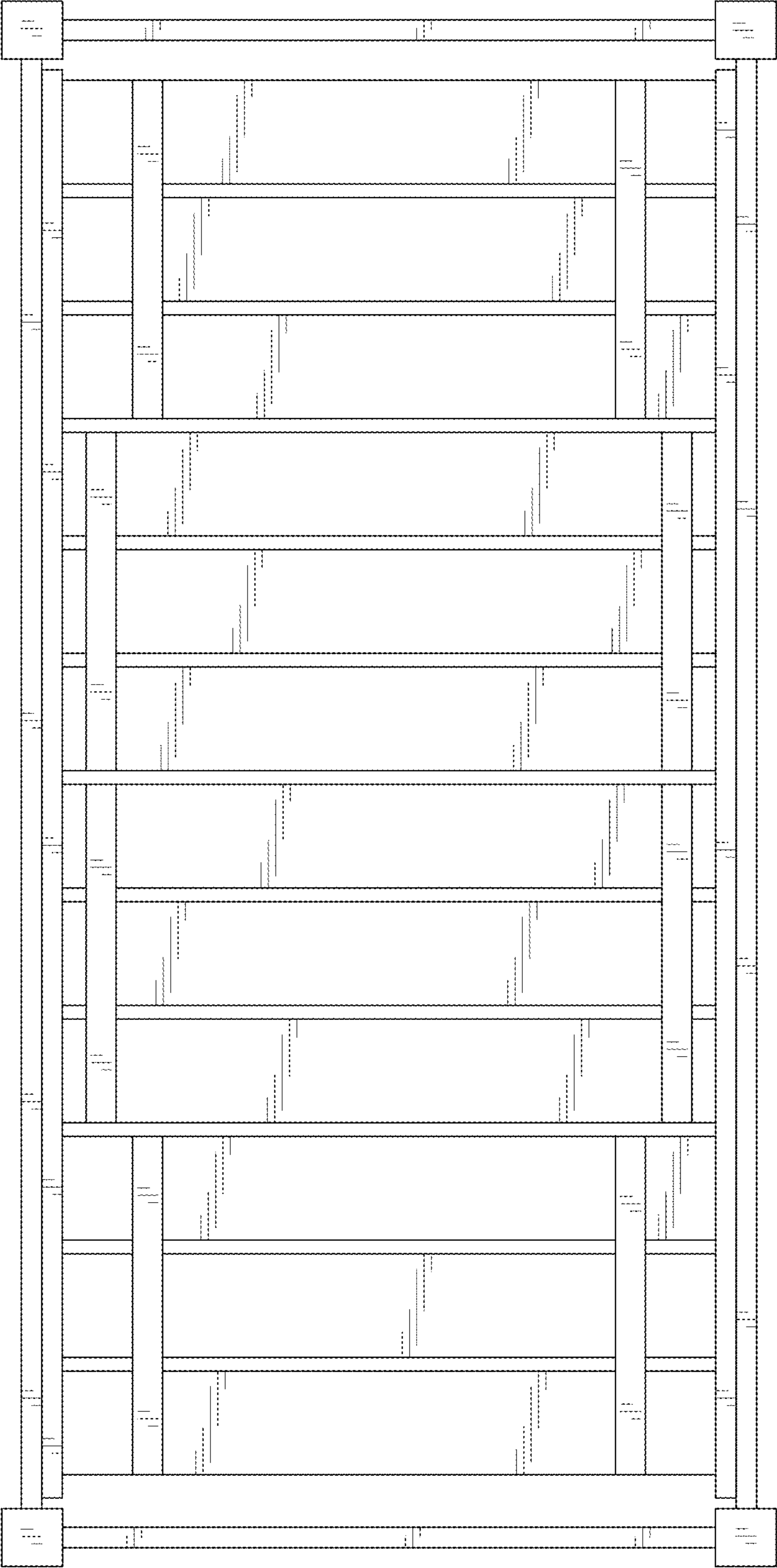

FIG. 7