



US00D948944S

(12) **United States Design Patent**
Roth et al.

(10) **Patent No.:** **US D948,944 S**

(45) **Date of Patent:** **** *Apr. 19, 2022**

(54) **BOTTLE WITH SNEAKER TREAD BASE**

(71) Applicant: **Cool Gear International, LLC**,
Plymouth, MA (US)

(72) Inventors: **Donna Roth**, Duxbury, MA (US);
Vincent Tsai, Quincy, MA (US)

(73) Assignee: **COOL GEAR INTERNATIONAL, LLC**,
Plymouth, MA (US)

(*) Notice: This patent is subject to a terminal disclaimer.

(**) Term: **15 Years**

(21) Appl. No.: **29/734,501**

(22) Filed: **May 13, 2020**

Related U.S. Application Data

(62) Division of application No. 29/655,622, filed on Jul. 5, 2018, now Pat. No. Des. 885,130.

(51) **LOC (13) Cl.** **07-01**

(52) **U.S. Cl.**
USPC **D7/510; D7/529; D7/532**

(58) **Field of Classification Search**
USPC D7/387, 392.1, 396.2, 393, 394, 397,
D7/398, 213, 900, 507, 523, 532, 510,
D7/511, 529, 533, 536, 534, 524, 537,
D7/514, 515, 522, 412, 376, 309, 317,
D7/305, 665, 300.1, 300.2; D9/435, 436,
D9/443, 442, 444, 449, 450, 437, 447;
D24/197
CPC A47G 19/2205; A47G 19/22; A47J 43/27;
A47J 41/02; A47J 41/0077; A47J
41/0088; A47J 41/028; A47J 31/407;
A47J 31/40; A45F 3/16; B65D 85/804;
B65D 41/04

See application file for complete search history.

(56) **References Cited**

U.S. PATENT DOCUMENTS

D760,541 S *	7/2016	Kane	D7/510
D779,882 S *	2/2017	Plott	D7/510
D786,620 S *	5/2017	Nickley	D7/511
D799,271 S *	10/2017	Pogue	D7/510
D805,355 S *	12/2017	Steel	D7/529
D808,714 S *	1/2018	Boroski	D7/396.4
D810,510 S *	2/2018	Serruya	D7/511

(Continued)

Primary Examiner — Jae Liang

(74) *Attorney, Agent, or Firm* — King & Spalding LLP

(57) **CLAIM**

The ornamental design for a bottle with sneaker tread base, as shown.

DESCRIPTION

FIG. 1 is a front, right perspective view of a first embodiment of a bottle with sneaker tread base showing our new design;

FIG. 2 is a front view thereof;

FIG. 3 is a back view thereof;

FIG. 4 is a left view thereof;

FIG. 5 is a right view thereof;

FIG. 6 is a top view thereof;

FIG. 7 is a bottom view thereof;

FIG. 8 is a back, left perspective view thereof;

FIG. 9 is a front, right perspective view of a second embodiment of a bottle with sneaker tread base showing our now design;

FIG. 10 is a front view thereof;

FIG. 11 is a back view thereof;

FIG. 12 is a left view thereof;

FIG. 13 is a right view thereof;

FIG. 14 is a top view thereof;

FIG. 15 is a bottom view thereof; and,

FIG. 16 is a back, left perspective view thereof.

The broken lines in the drawings are included for the purpose of illustration and form no part of the claimed design.

1 Claim, 16 Drawing Sheets

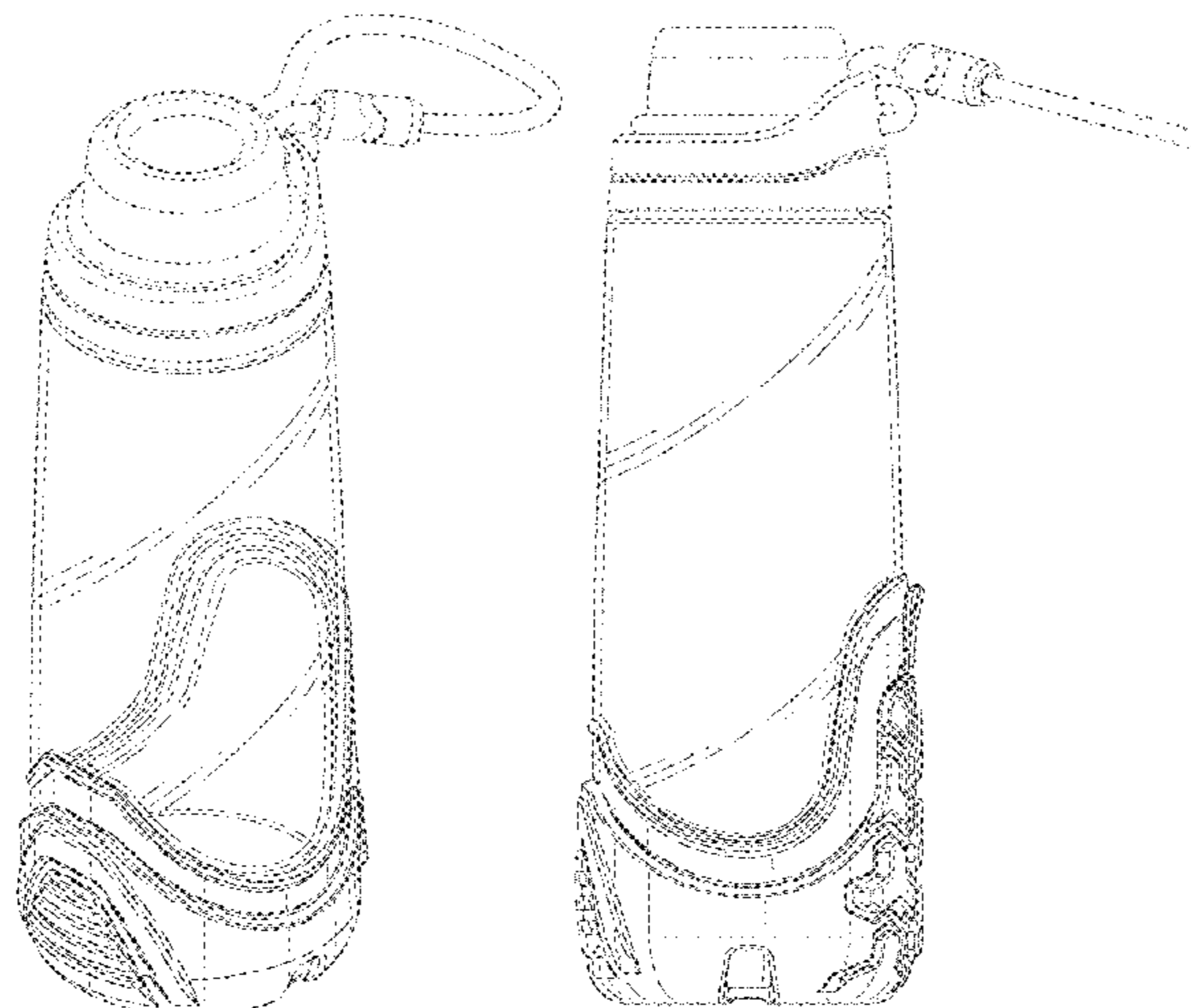

(56)

References Cited

U.S. PATENT DOCUMENTS

D814,241 S * 4/2018 Nickley D7/510
D829,507 S * 10/2018 Breit D7/529
2003/0080135 A1* 5/2003 Bezek B65D 1/165
220/673
2012/0187160 A1* 7/2012 Wolf A45C 11/00
224/148.4
2016/0316896 A1* 11/2016 Breit A45F 3/16
2017/0127859 A1* 5/2017 Hornung A45F 3/18
2018/0279815 A1* 10/2018 Hakim A47G 19/2272

* cited by examiner

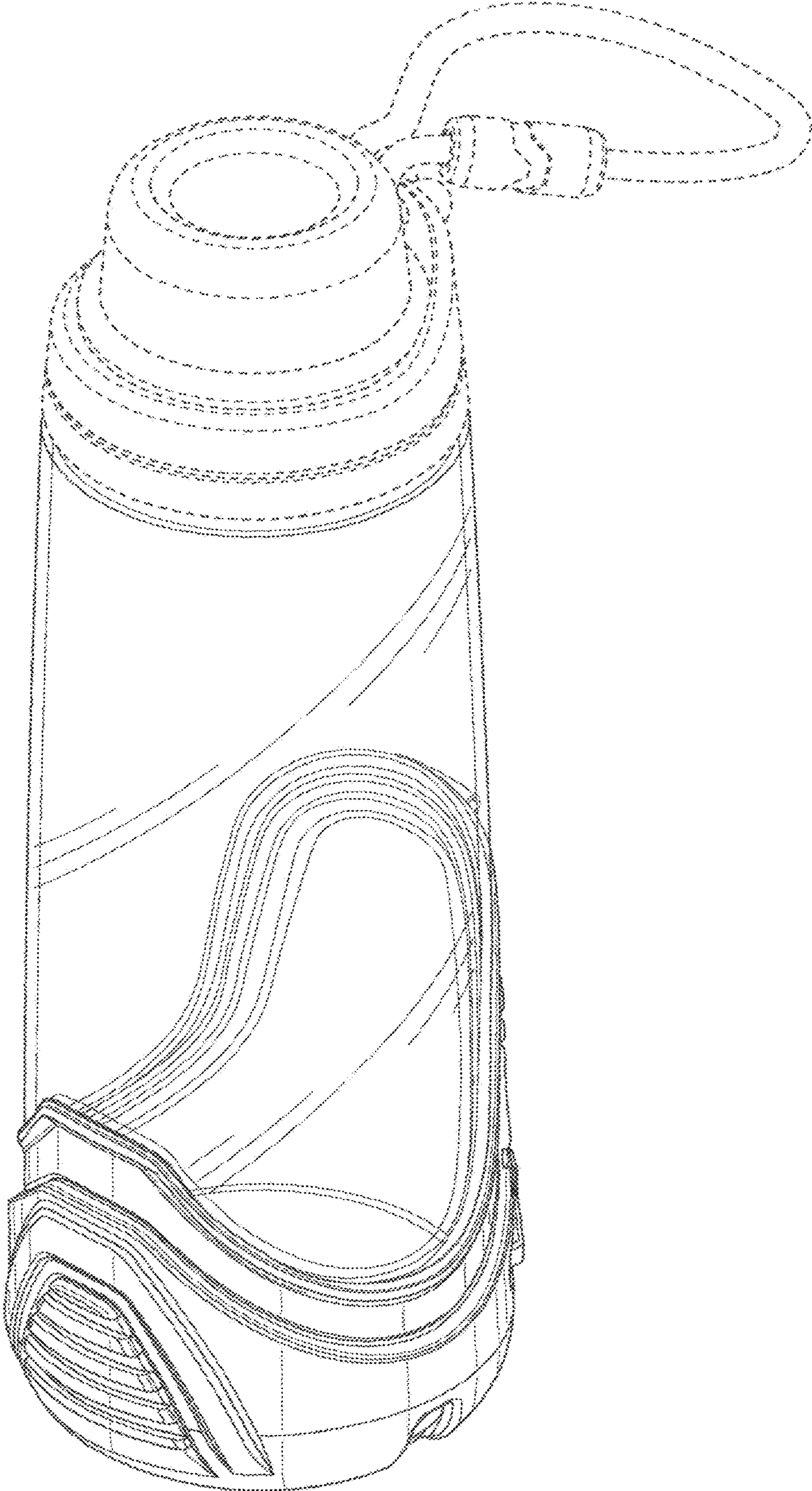

FIG. 1

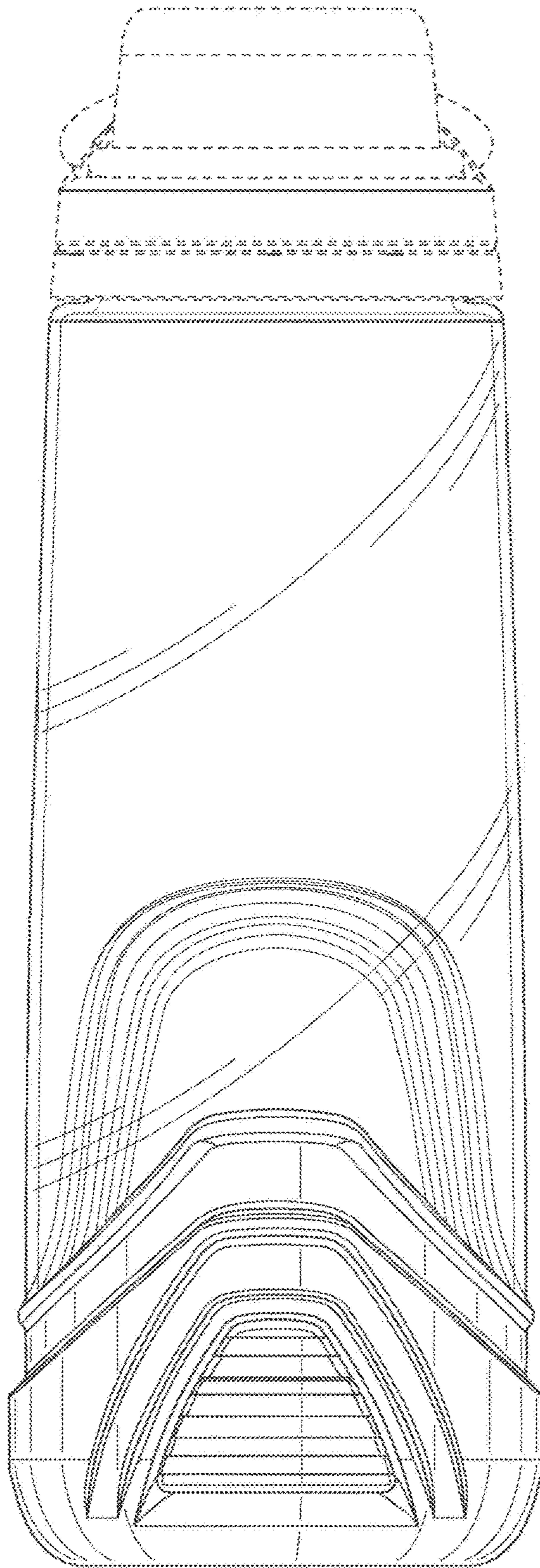

FIG. 2

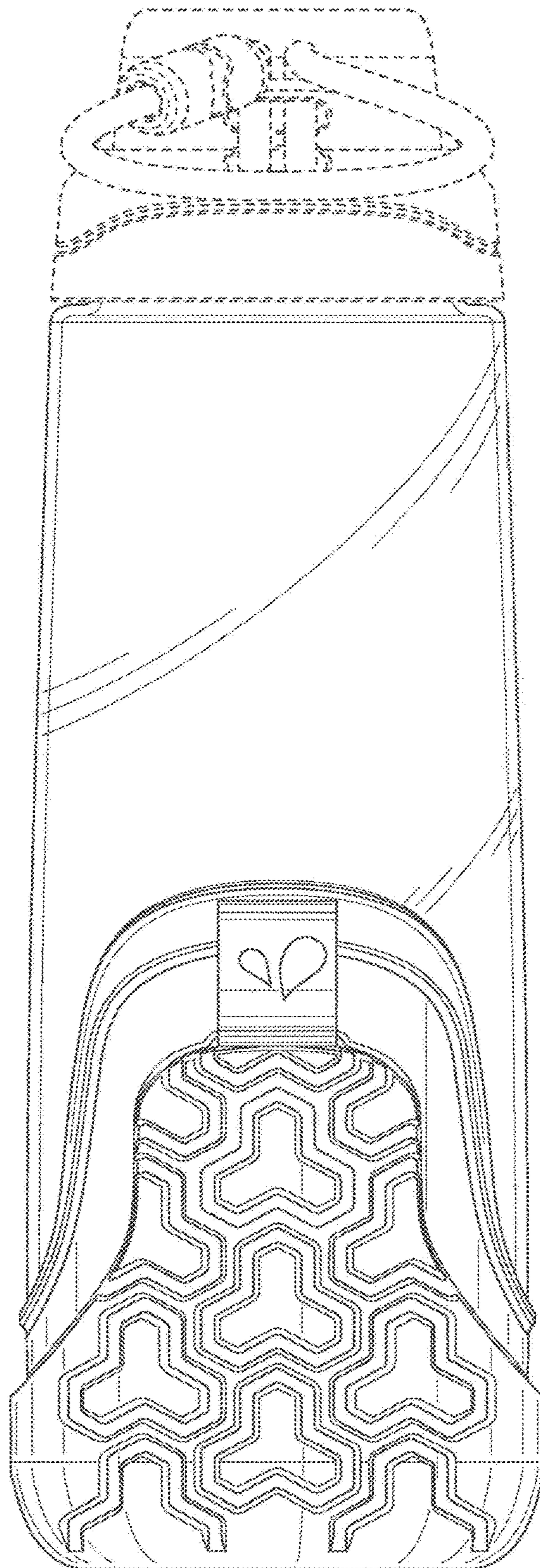

FIG. 3

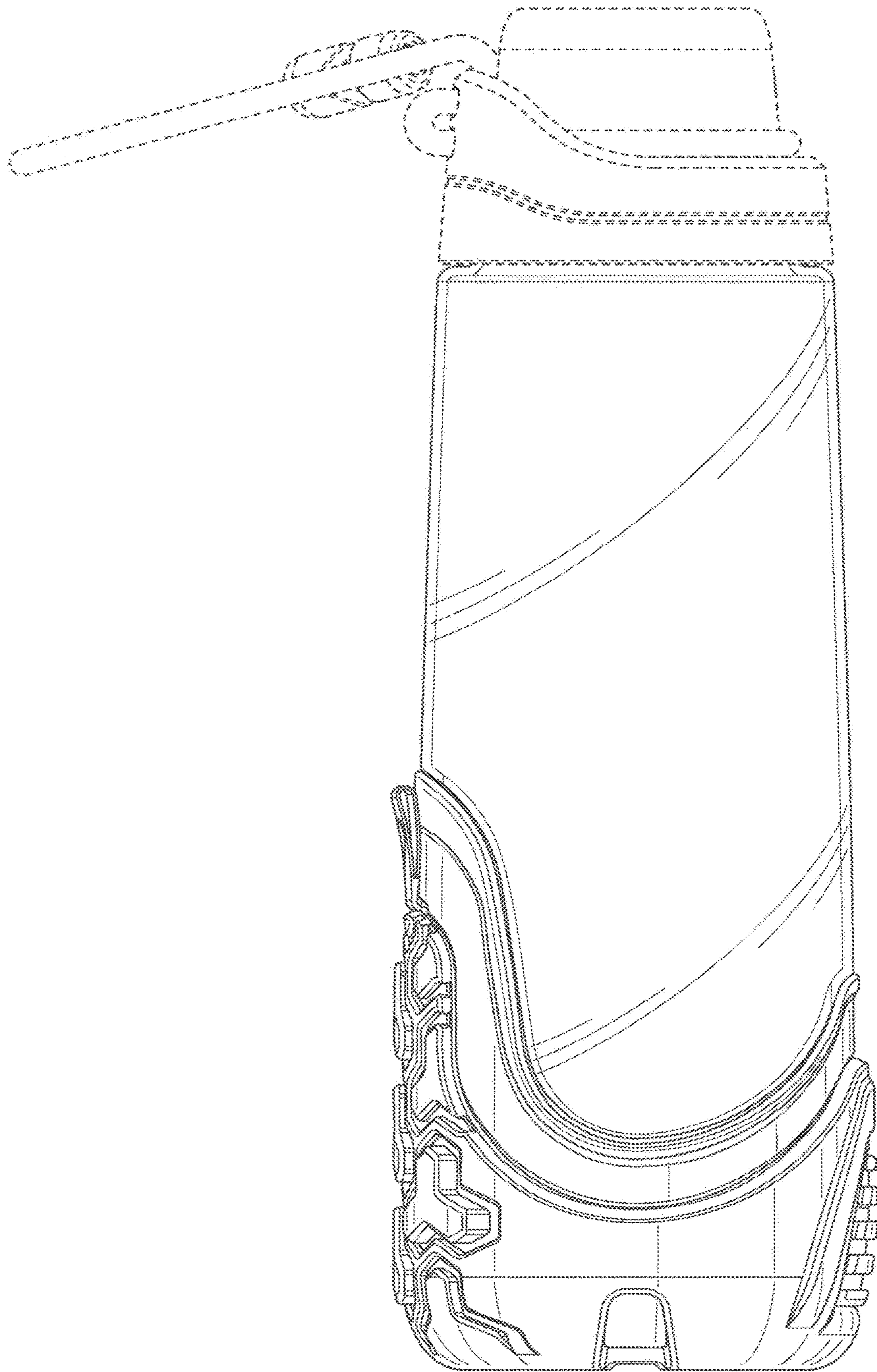

FIG. 4

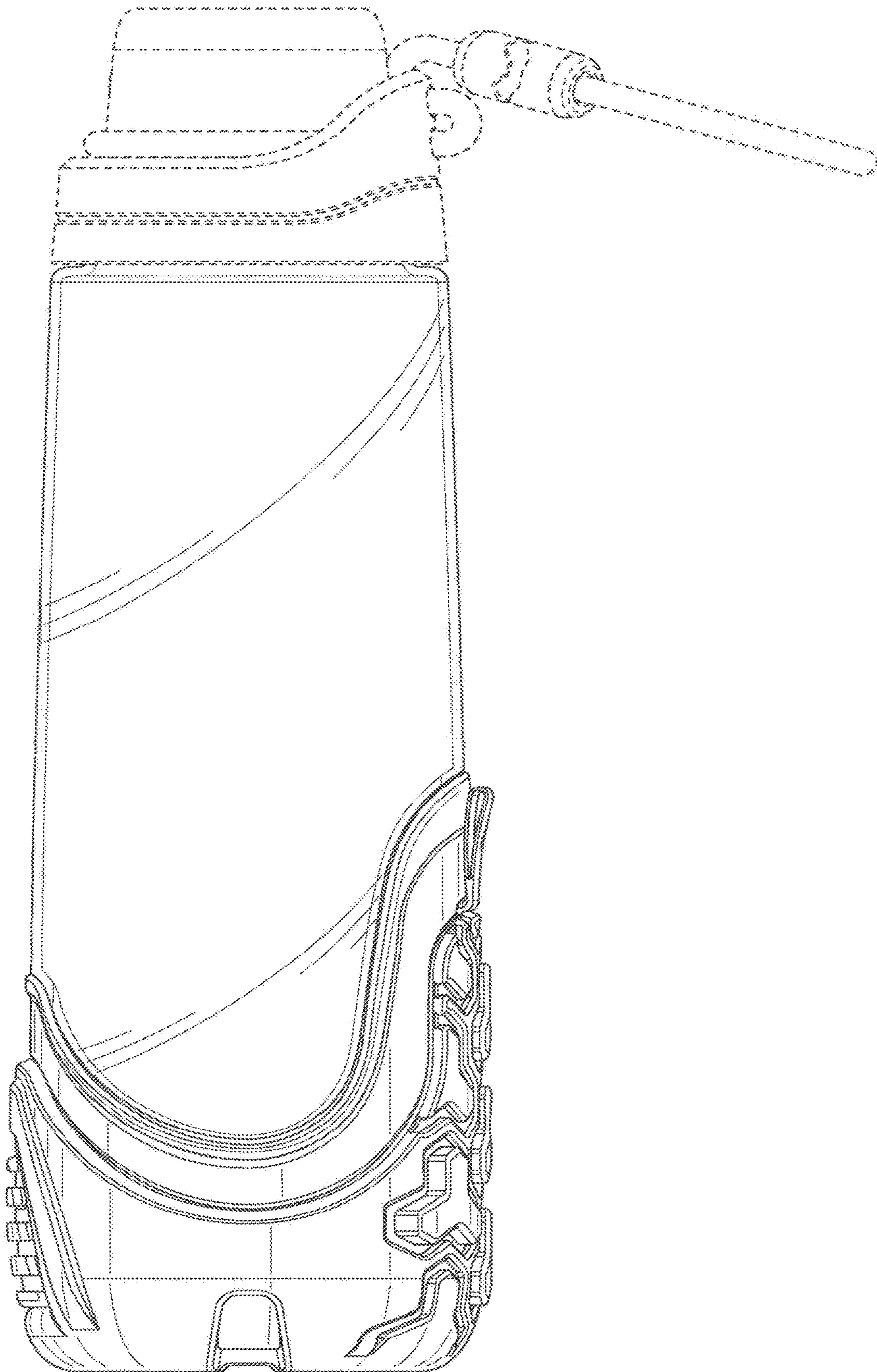

FIG. 5

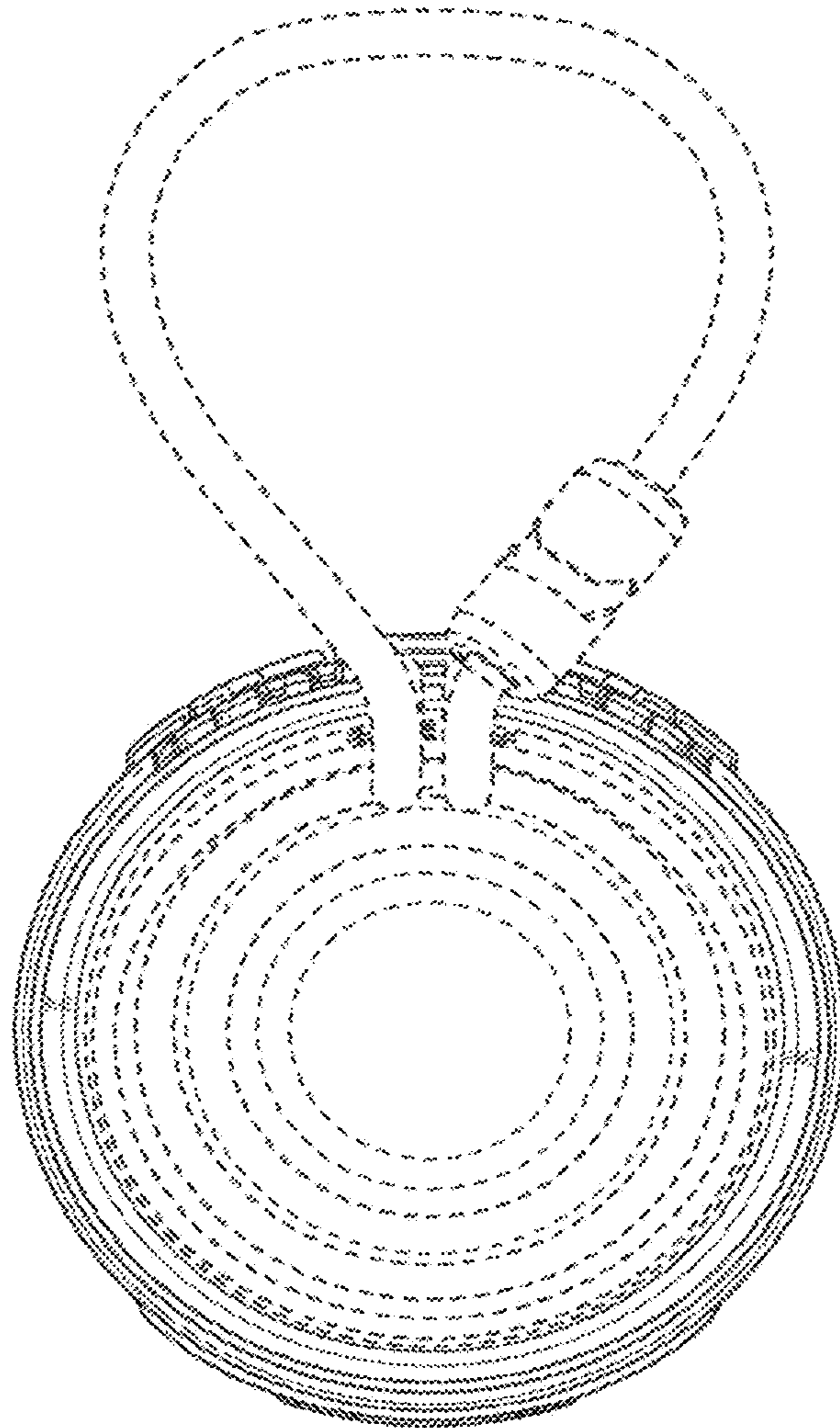

FIG. 6

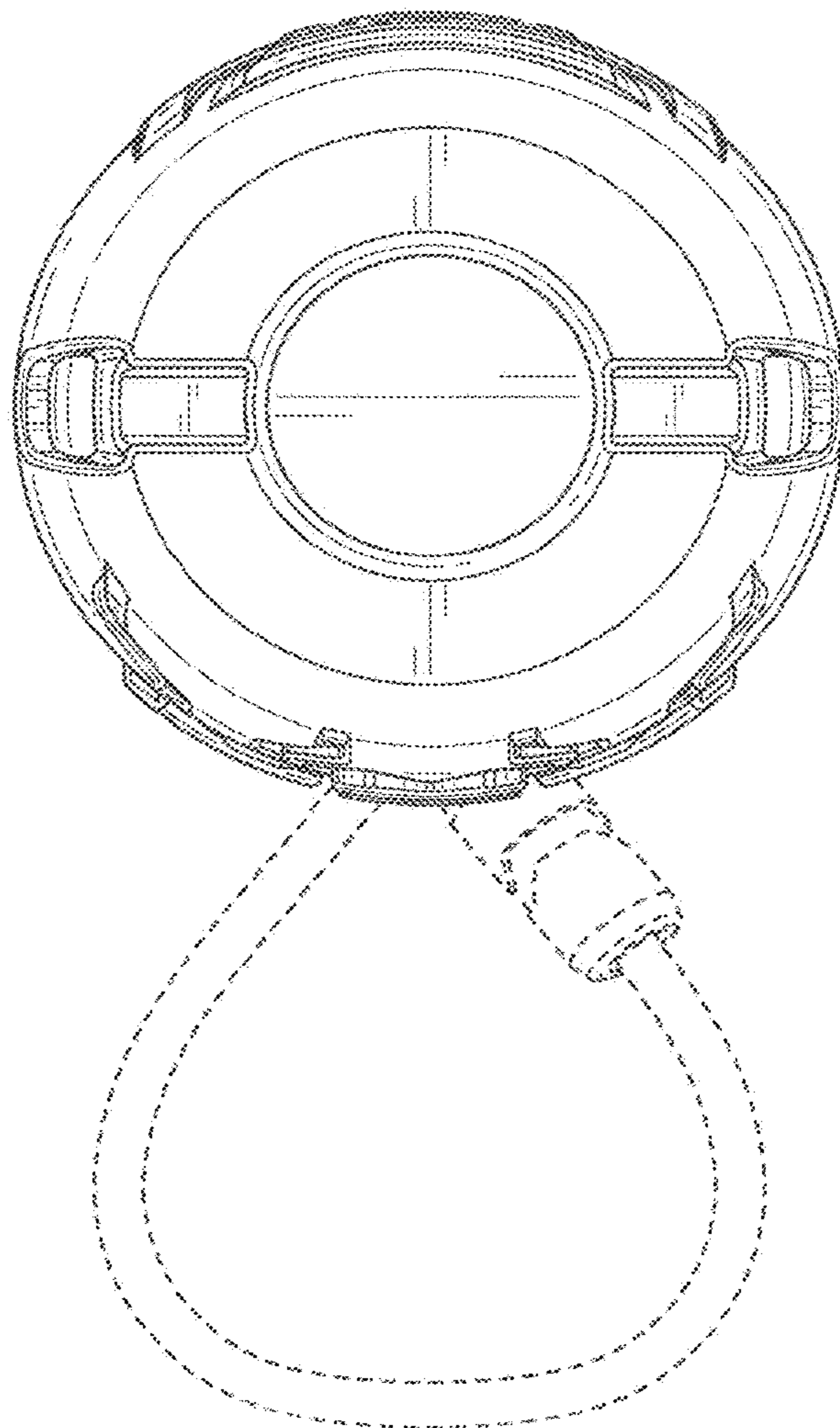

FIG. 7

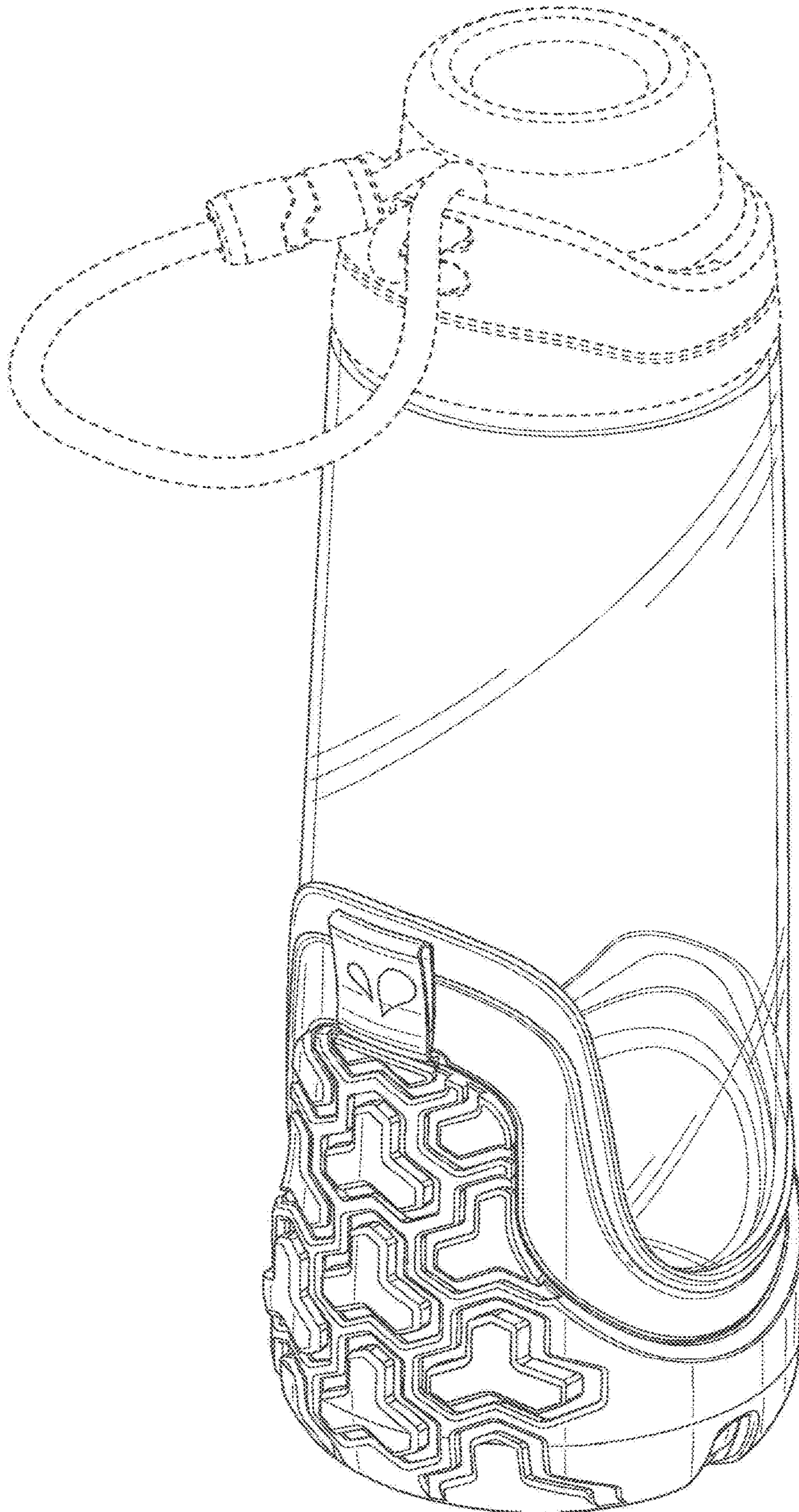

FIG. 8

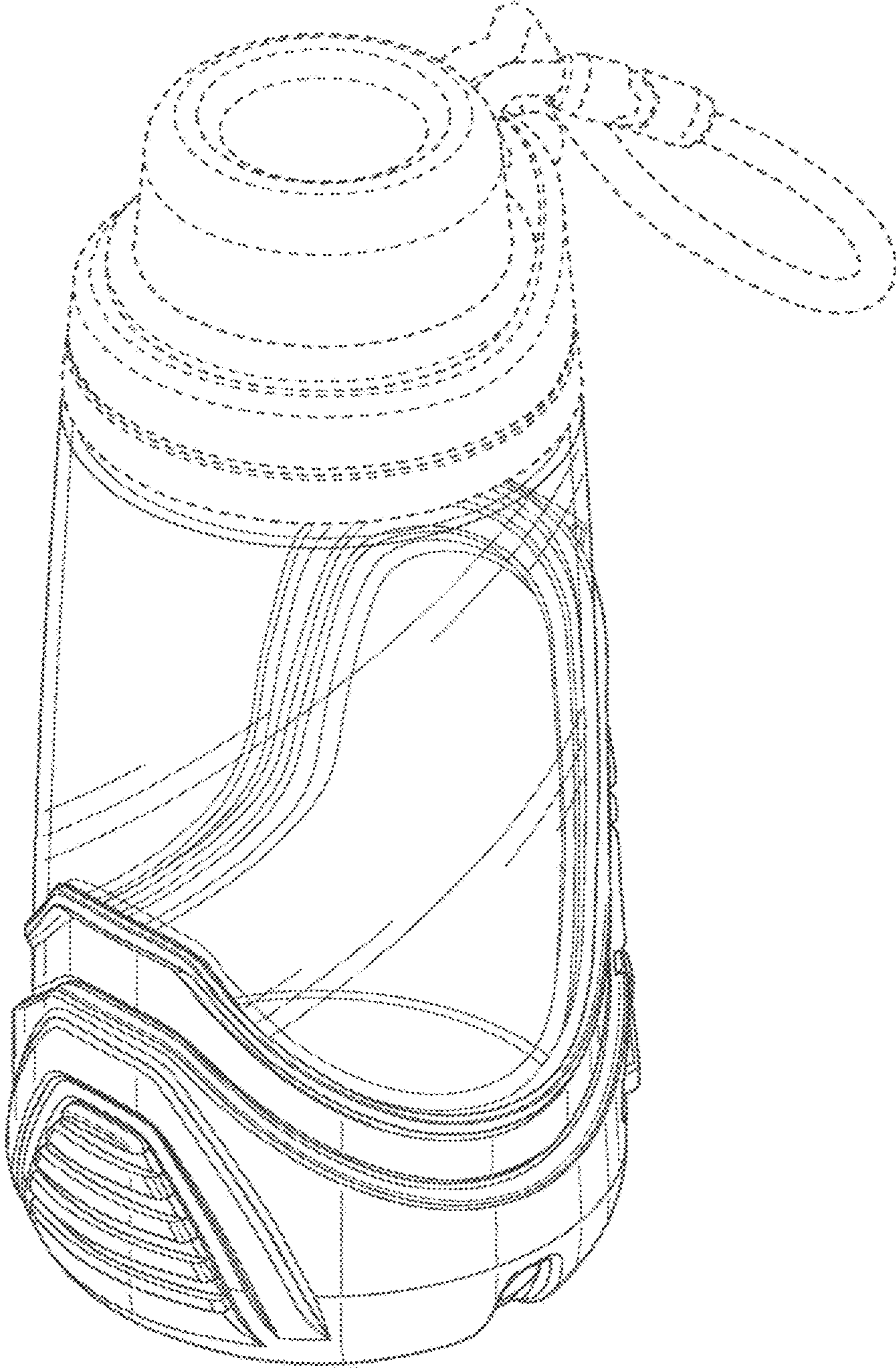

FIG. 9

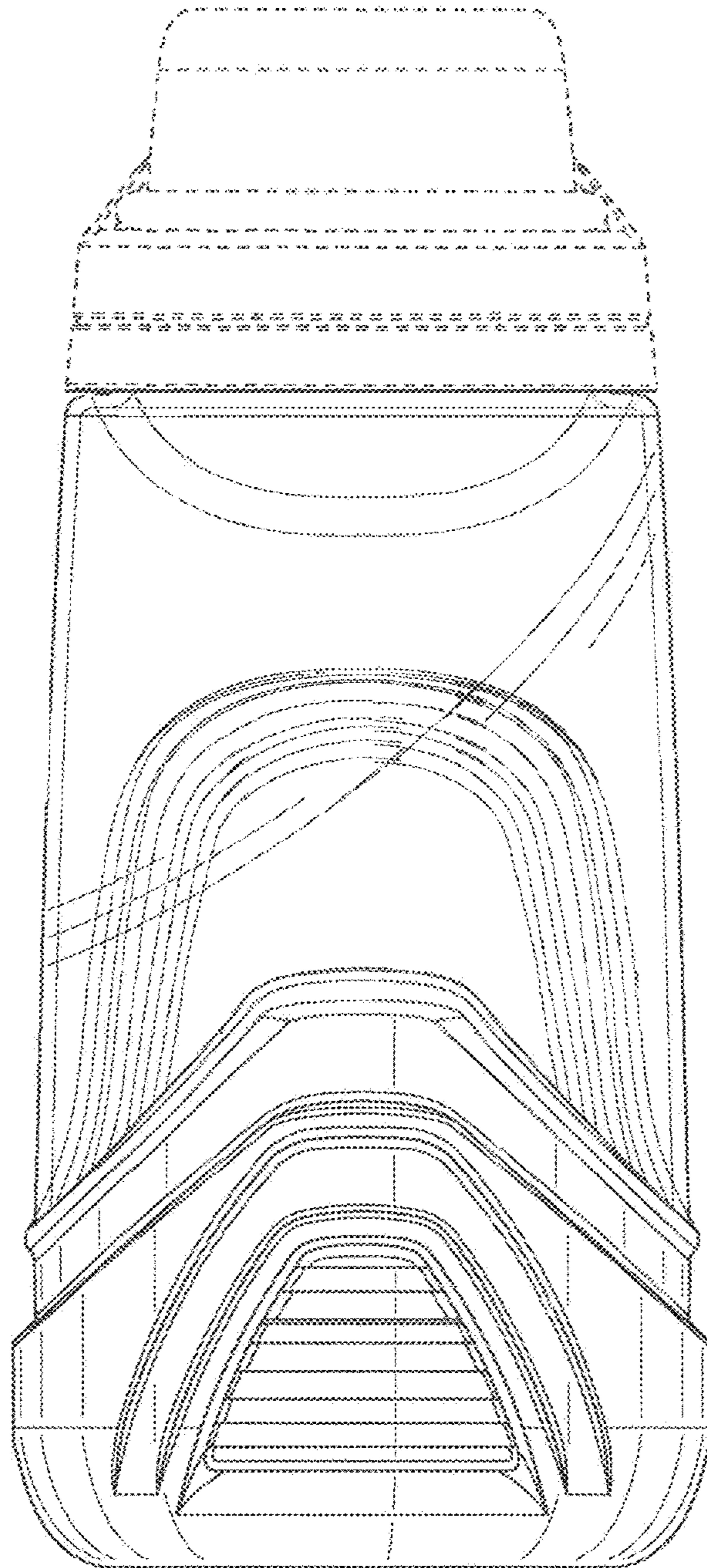

FIG. 10

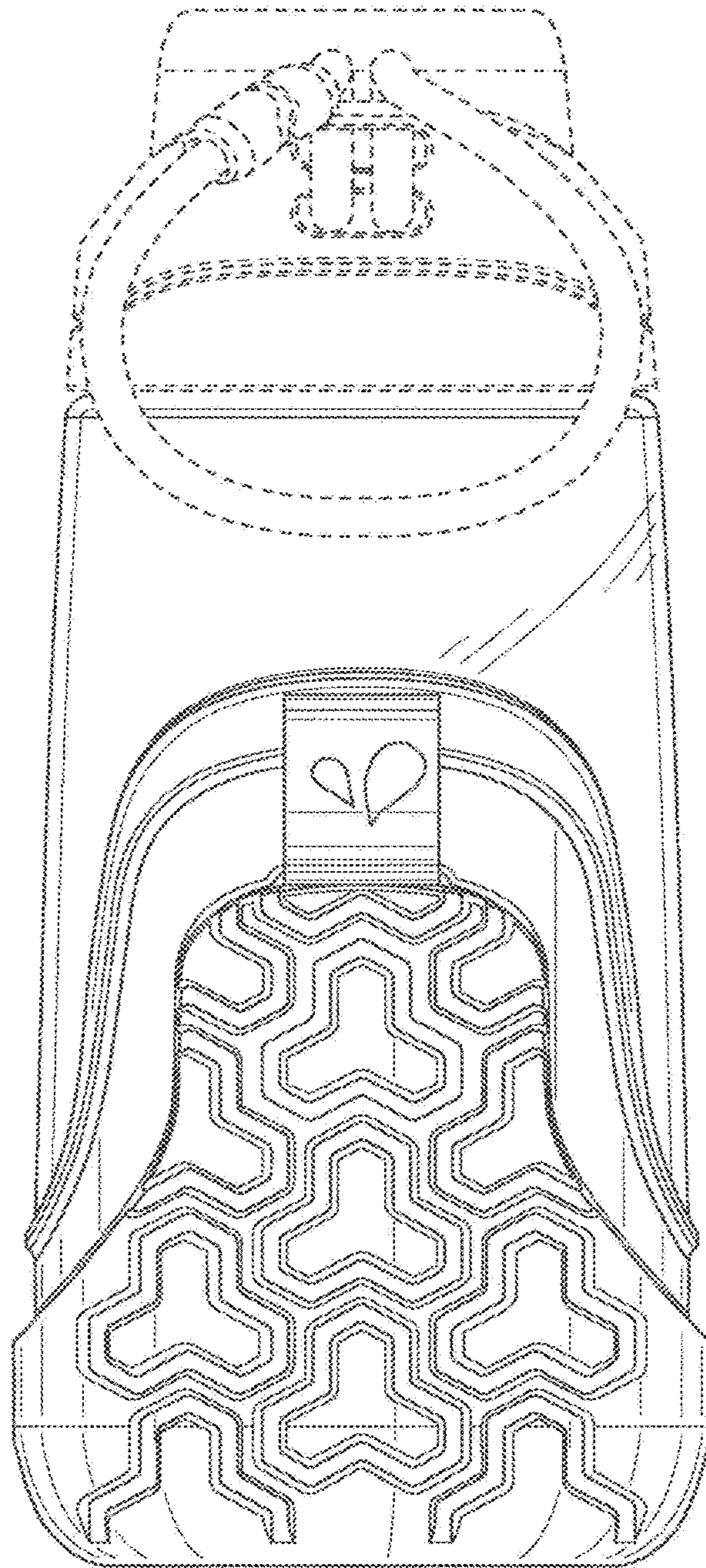

FIG. 11

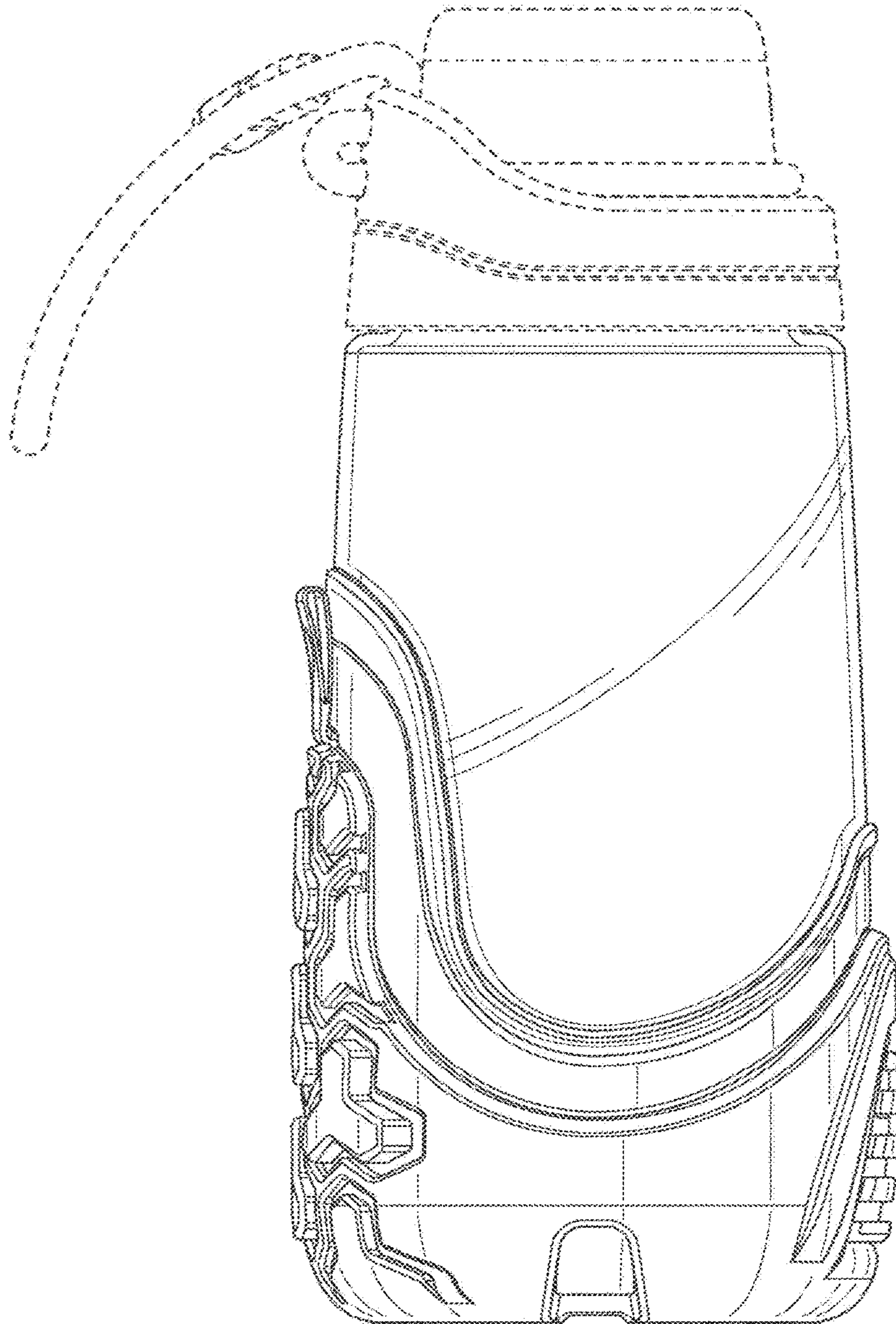

FIG. 12

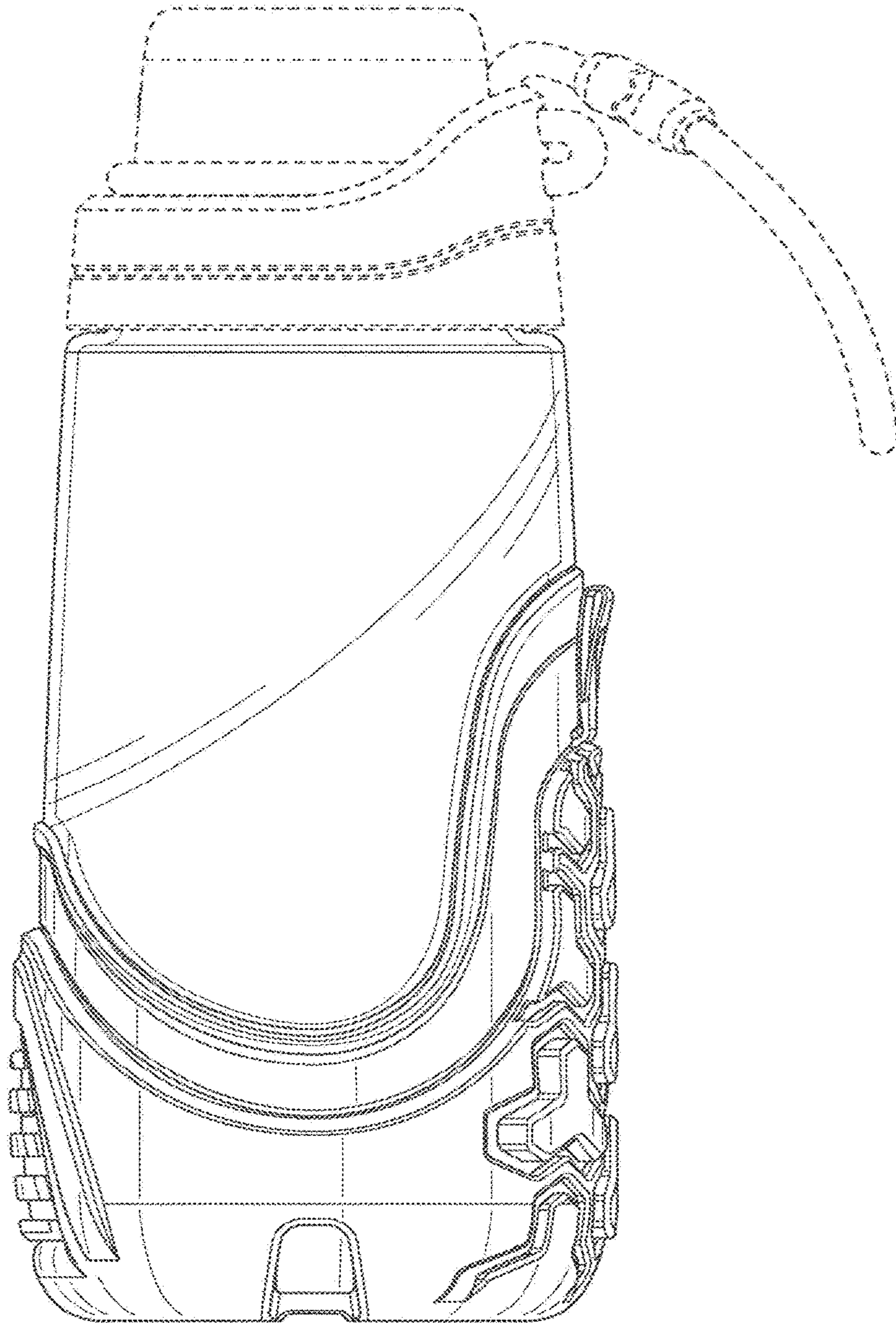

FIG. 13

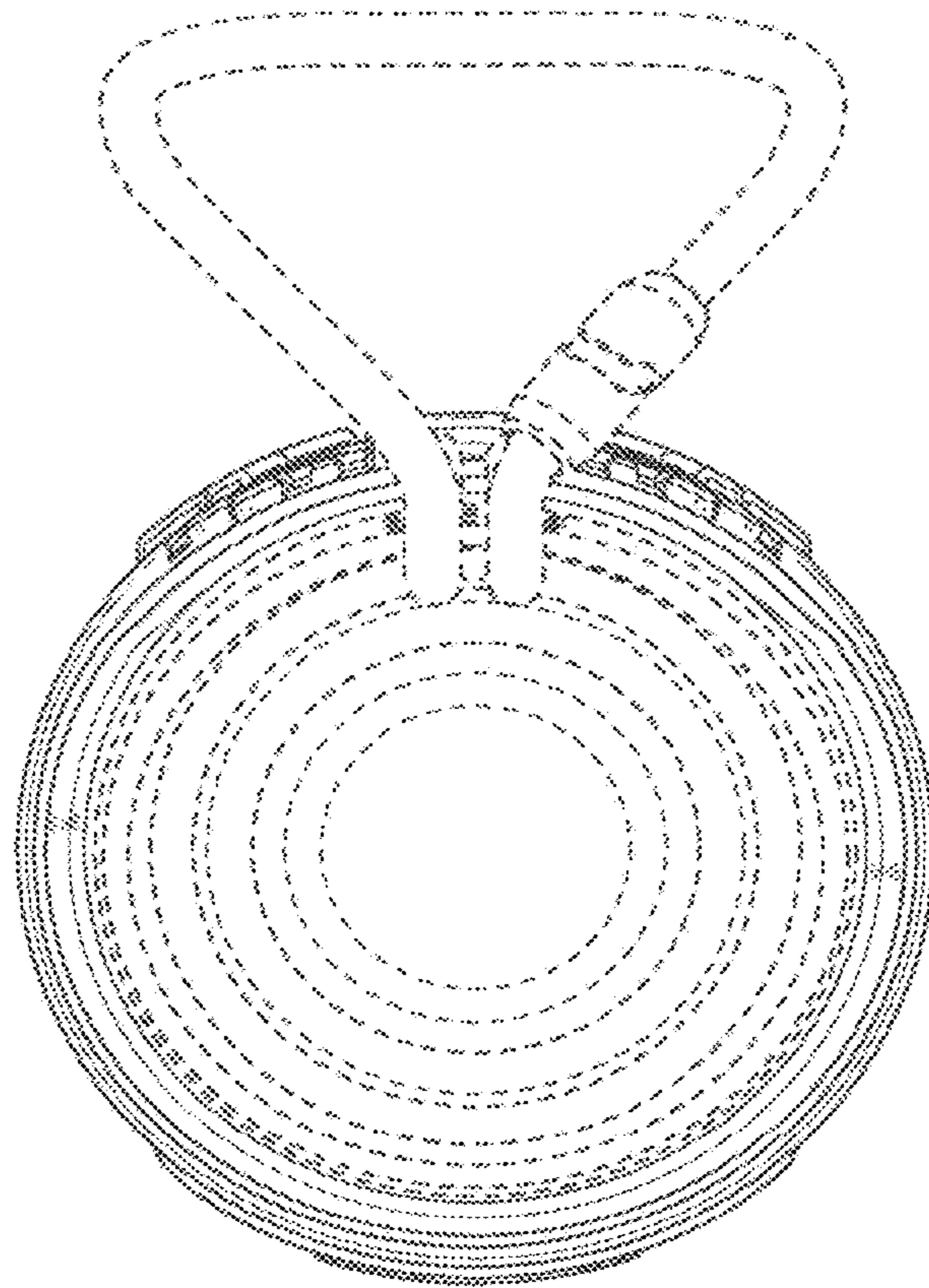

FIG. 14

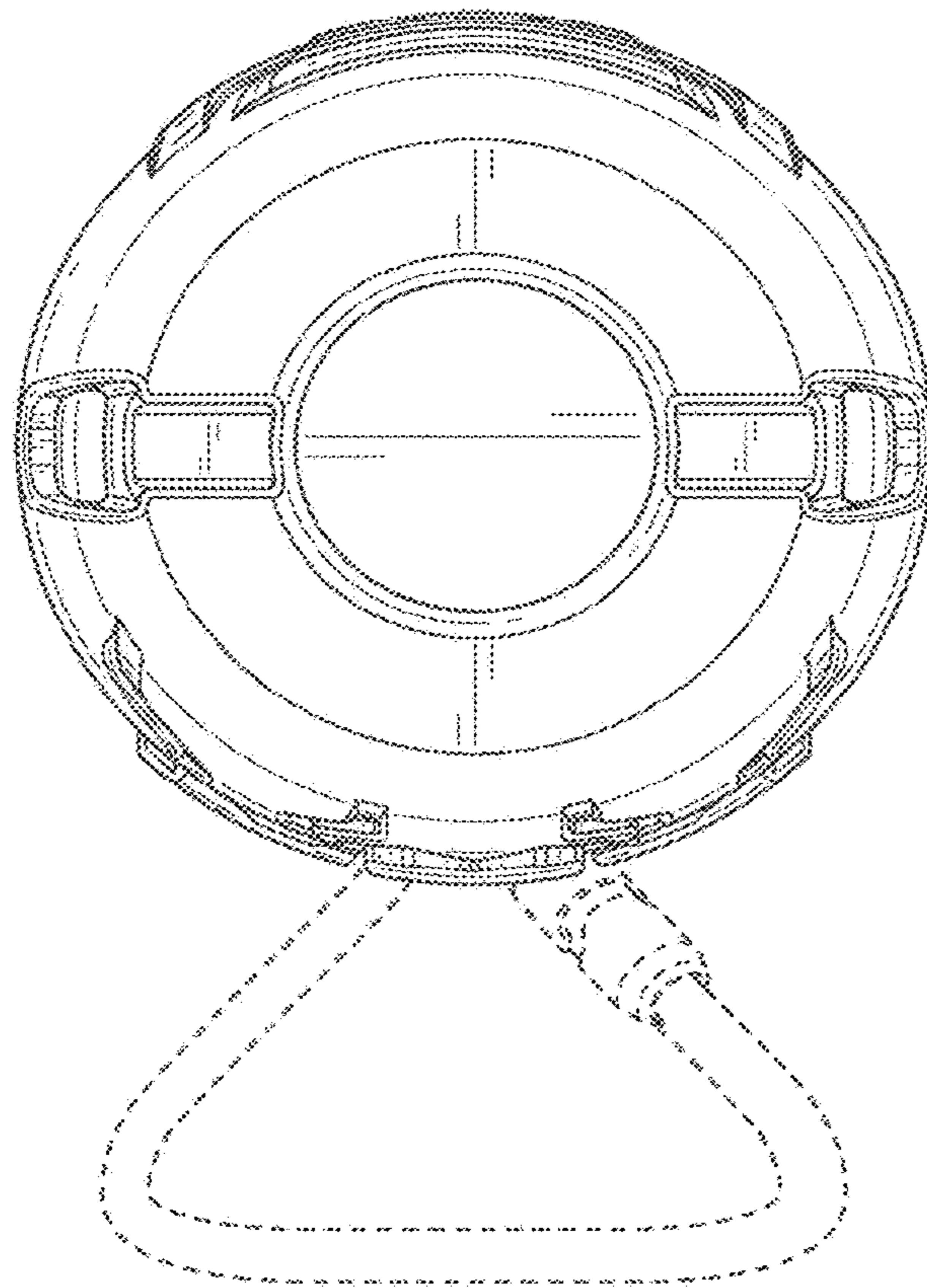

FIG. 15

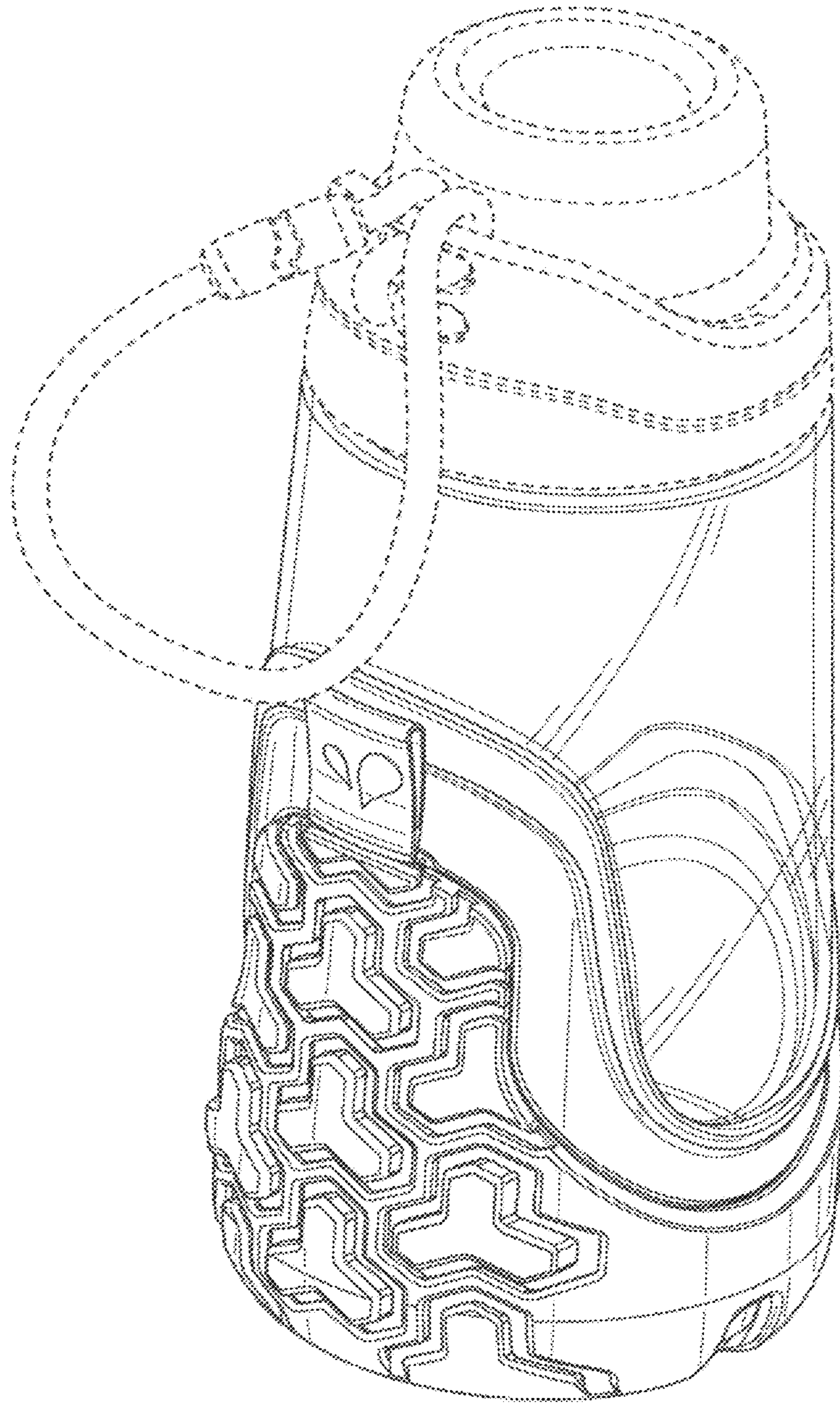

FIG. 16