

US00D948909S

(12) **United States Design Patent**
Sun et al.

(10) **Patent No.:** **US D948,909 S**

(45) **Date of Patent:** **** Apr. 19, 2022**

(54) **WATER DISPENSER**

(71) Applicant: **NINGBO AQUART ELECTRICAL APPLIANCE CO., LTD.**, Ningbo (CN)

(72) Inventors: **Yucheng Sun**, Wujiaqu (CN); **Nie Cen**, Cixi (CN); **Jiajie Liu**, Cixi (CN)

(73) Assignee: **NINGBO AQUART ELECTRICAL APPLIANCE CO., LTD.**, Ningbo (CN)

(**) Term: **15 Years**

(21) Appl. No.: **29/753,111**

(22) Filed: **Sep. 30, 2020**

(51) **LOC (13) Cl.** **07-01**

(52) **U.S. Cl.**
USPC **D7/307**

(58) **Field of Classification Search**
USPC D7/300, 304–311, 312, 313, 213, 397, D7/399, 400; D15/79, 81, 89, 91
CPC A47J 31/00; B67D 1/00; B67D 1/0003; B67D 1/0004; B67D 1/0005; F25D 23/12; F25D 23/126; Y10T 137/00; Y10T 137/0318; Y10T 137/0379
See application file for complete search history.

(56) **References Cited**

U.S. PATENT DOCUMENTS

4,881,380 A * 11/1989 Mrugala B67D 1/0858
62/389

D643,240 S * 8/2011 Yui D7/307
D643,666 S * 8/2011 Yui D7/307
D700,794 S * 3/2014 Yui D7/305
D813,346 S * 3/2018 Lee D23/207
D842,966 S * 3/2019 Shin D23/207
D882,337 S * 4/2020 Moon D7/397
D884,407 S * 5/2020 Tan D7/313

* cited by examiner

Primary Examiner — Andrew Kerr

(57) **CLAIM**

The ornamental design for a water dispenser, as shown and described.

DESCRIPTION

FIG. 1 is a perspective view of a water dispenser showing my new design;
FIG. 2 is another perspective view thereof;
FIG. 3 is a front elevational view thereof;
FIG. 4 is a rear elevational view thereof;
FIG. 5 is a left side elevational view thereof;
FIG. 6 is a right side elevational view thereof;
FIG. 7 is a top plan view thereof; and,
FIG. 8 is a bottom plan view thereof.
The broken lines in the drawings depict portions of the water dispenser that form no part of the claimed design.

1 Claim, 8 Drawing Sheets

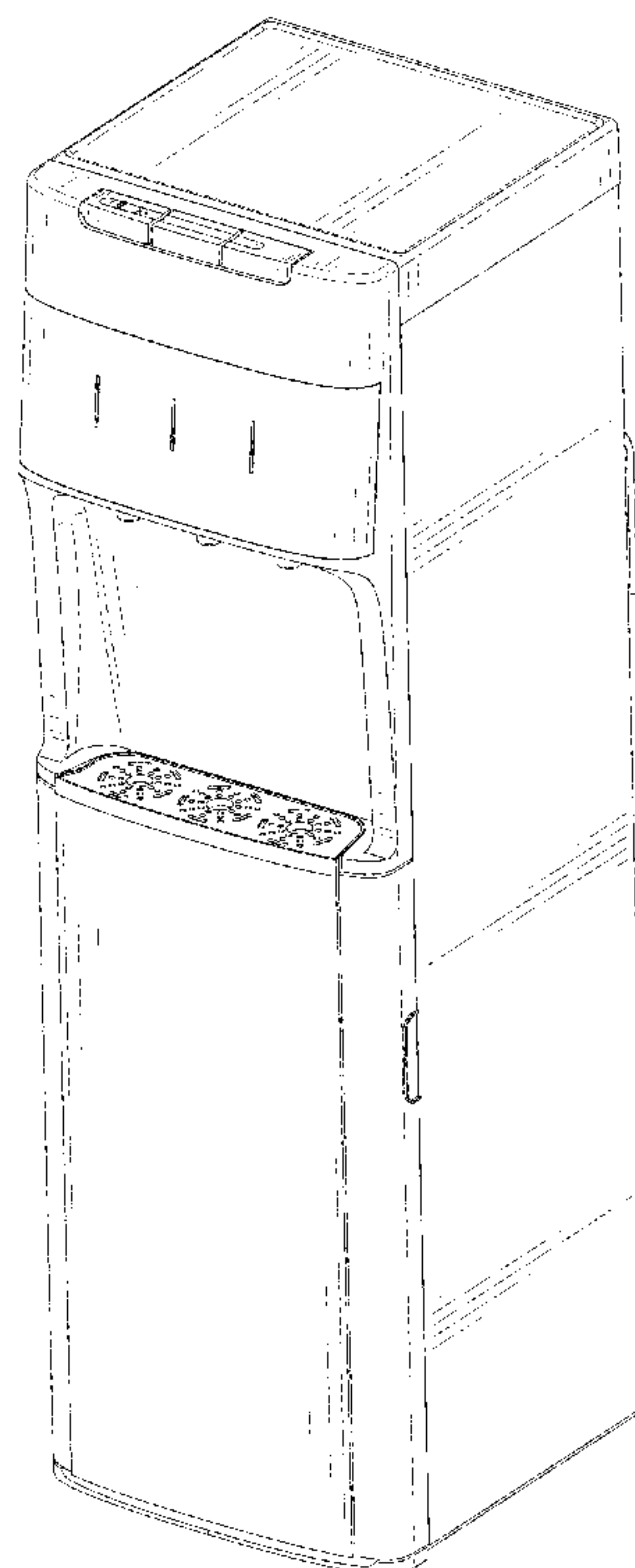

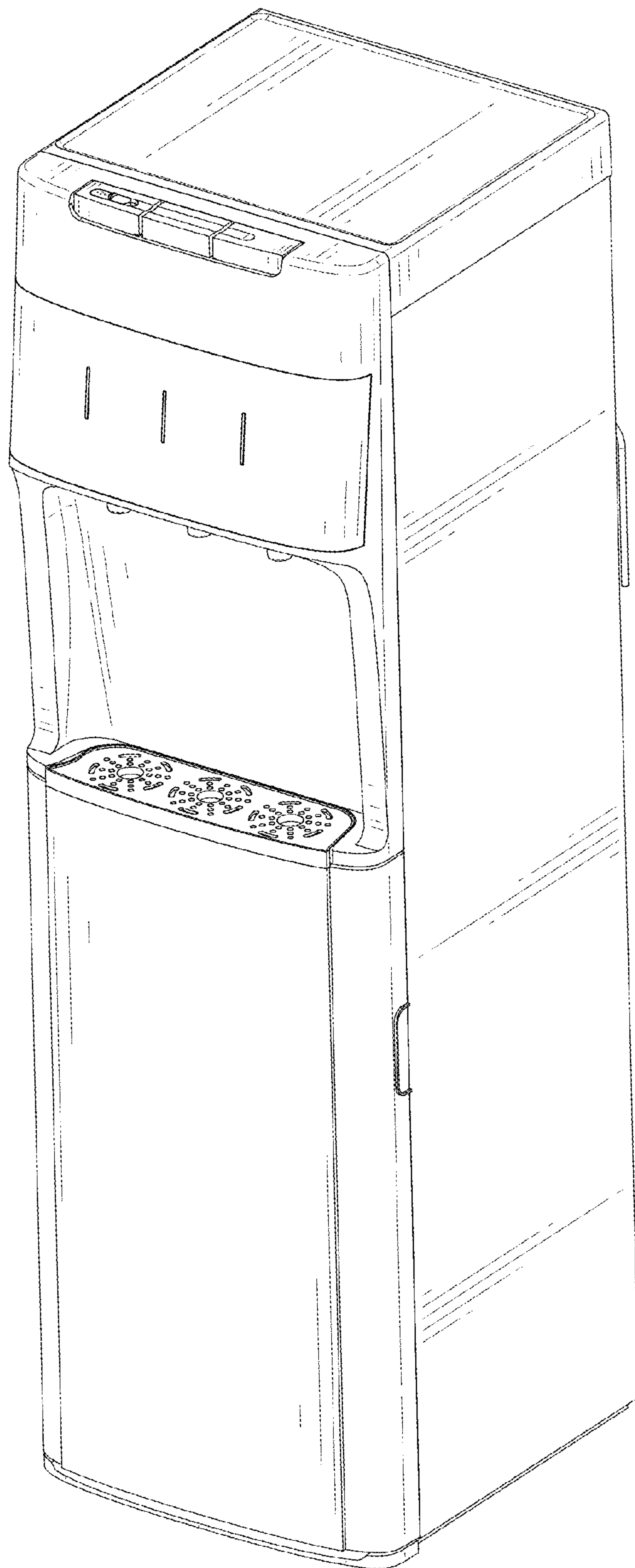

FIG. 1

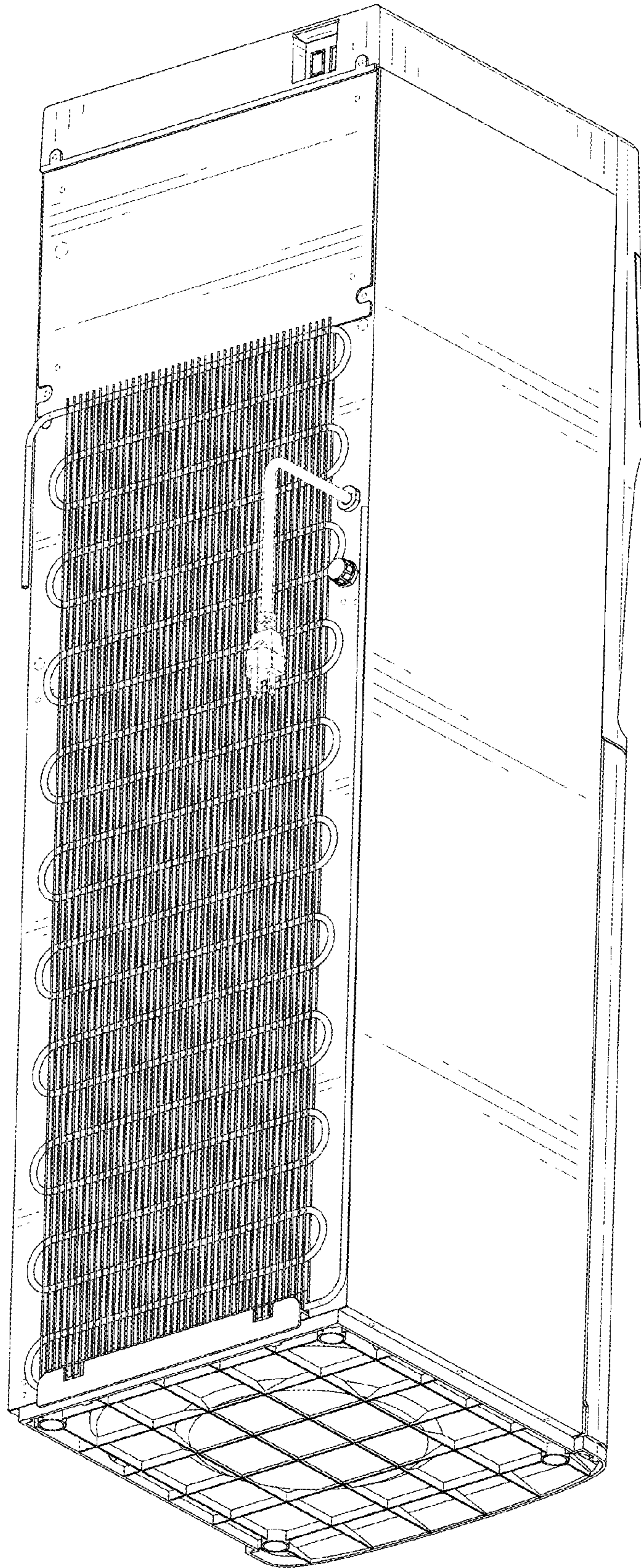

FIG. 2

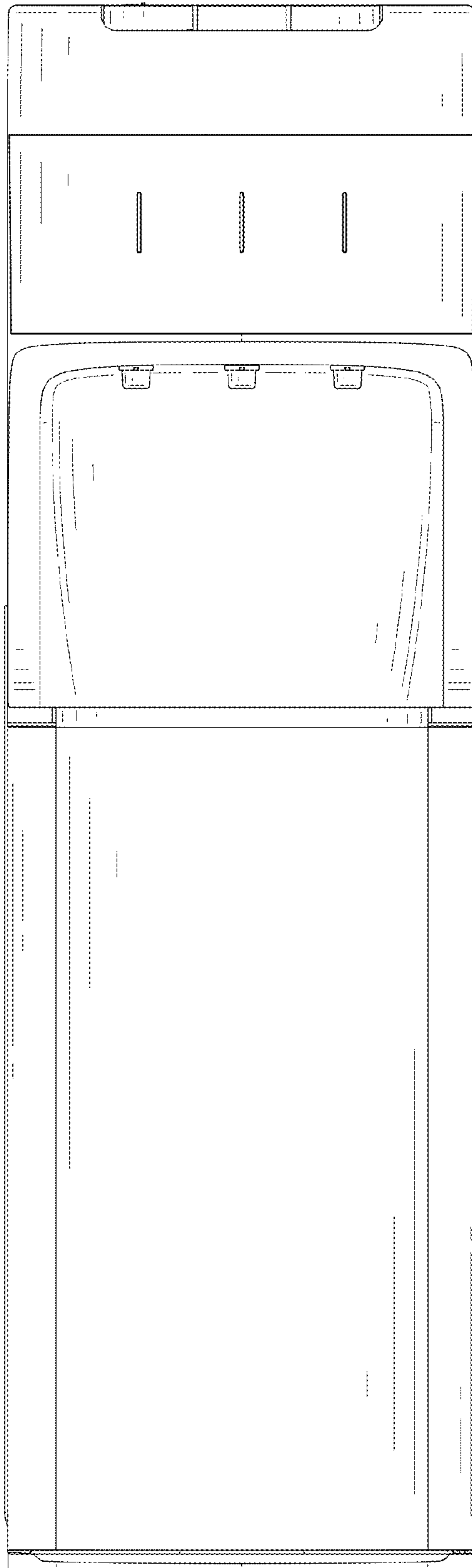

FIG. 3

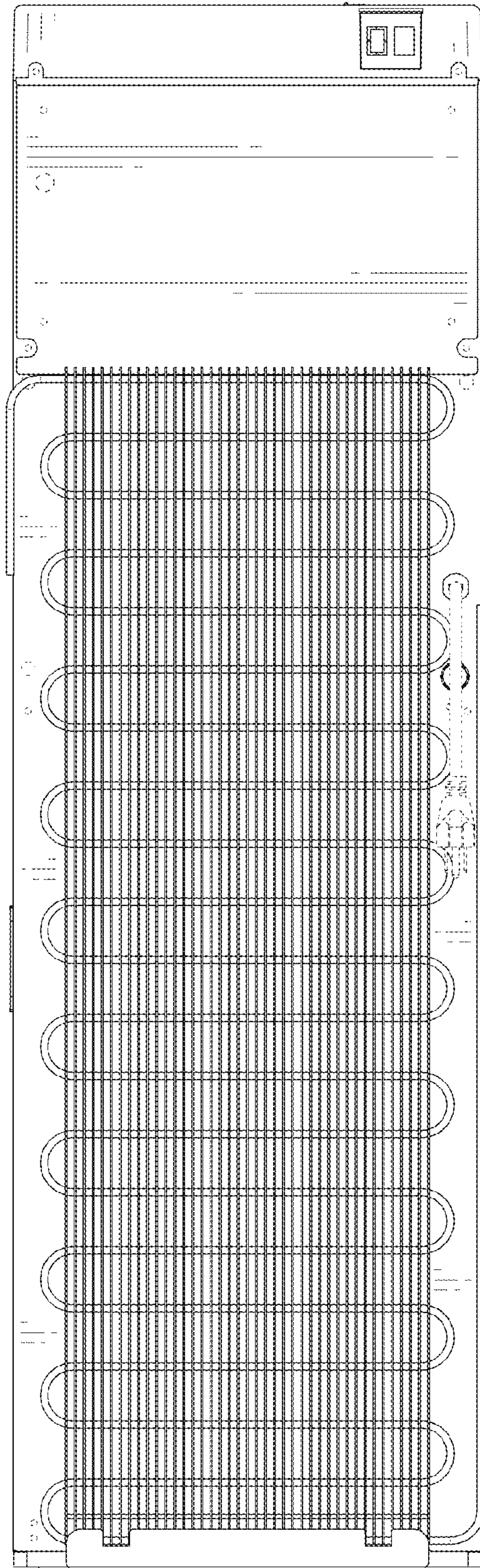

FIG. 4

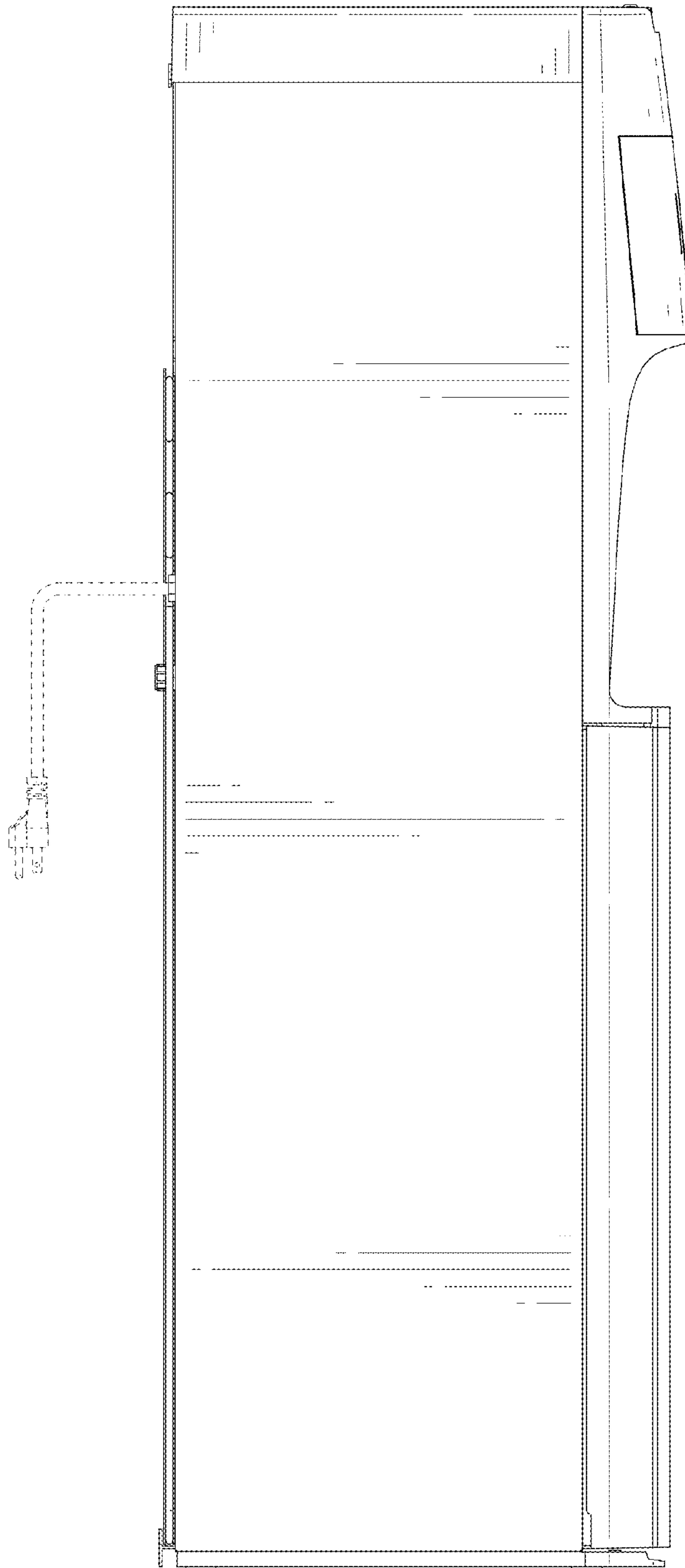

FIG. 5

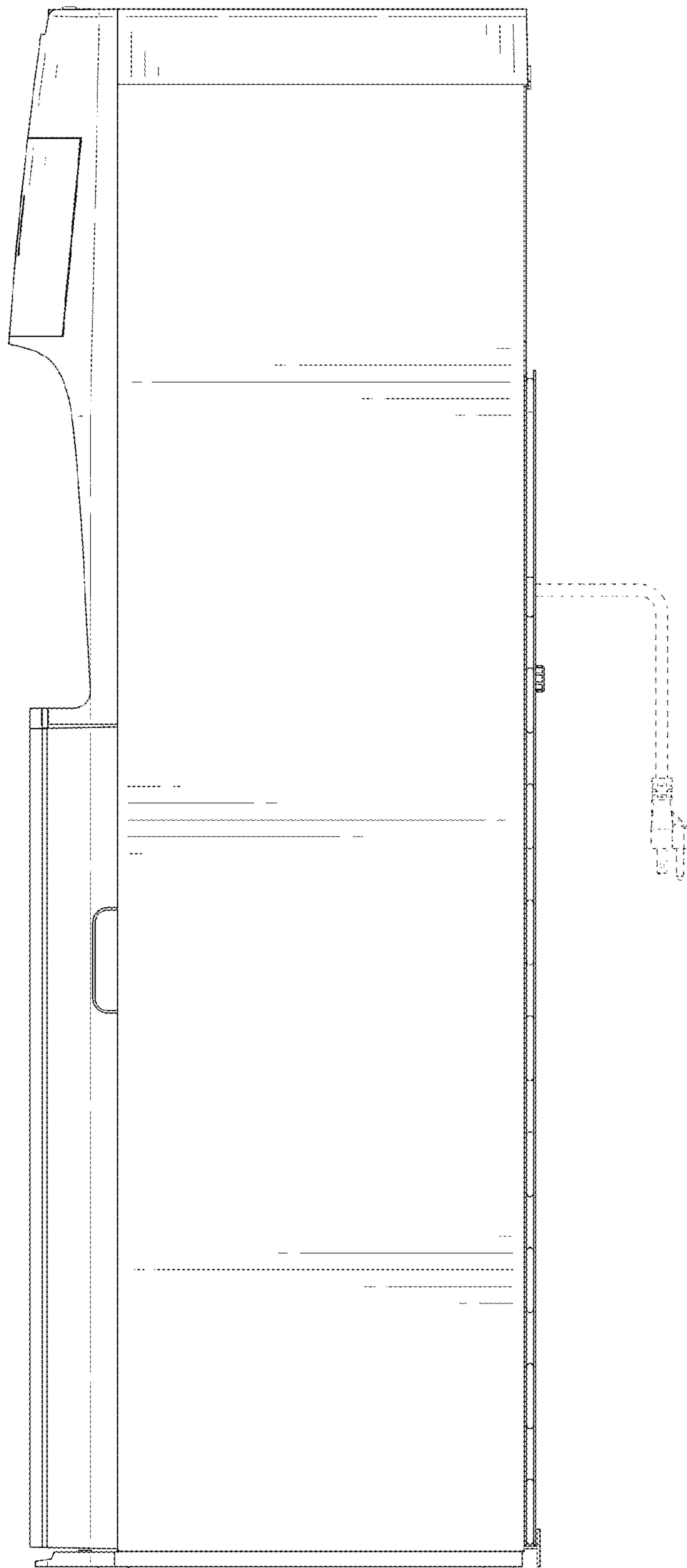

FIG. 6

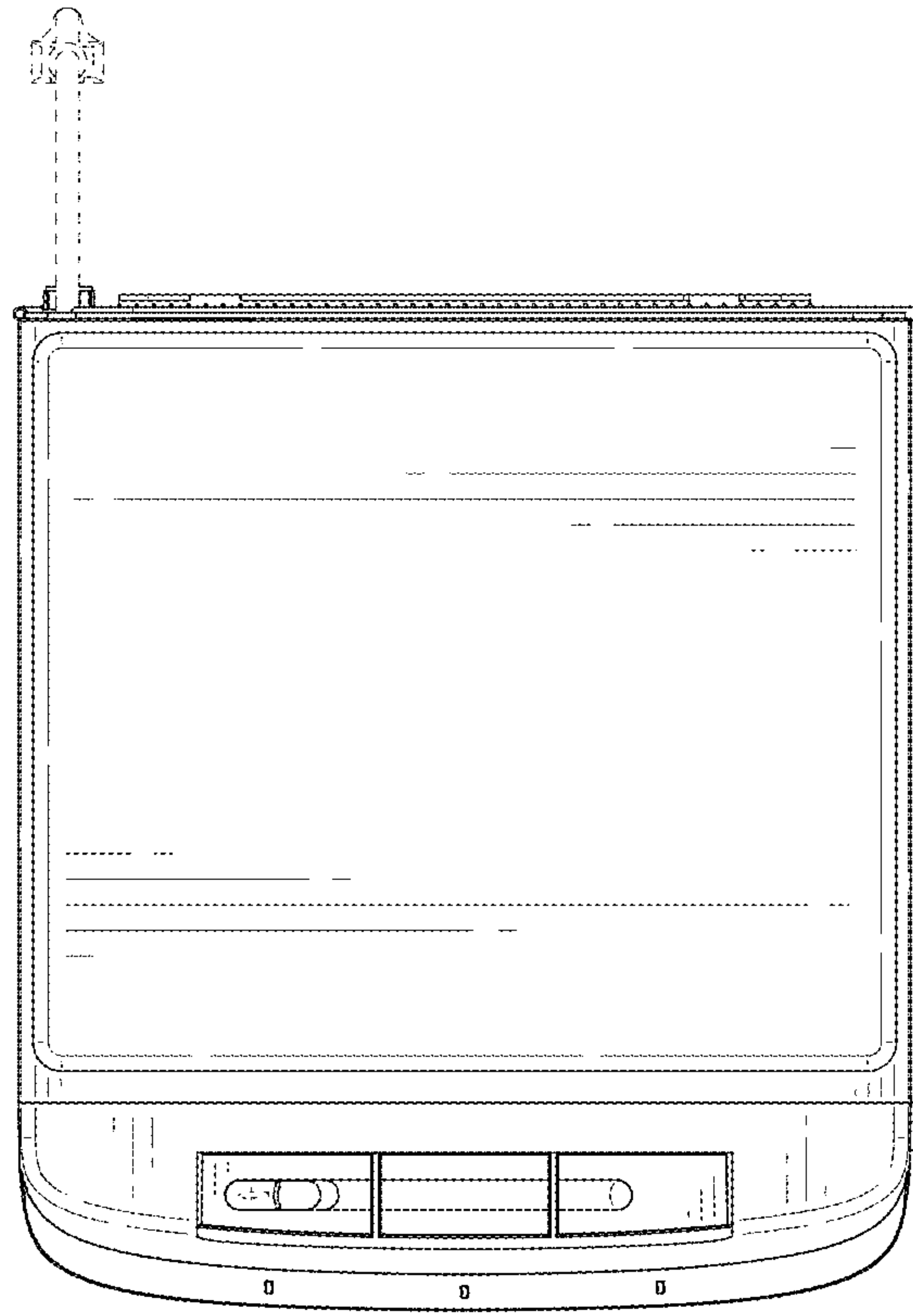

FIG. 7

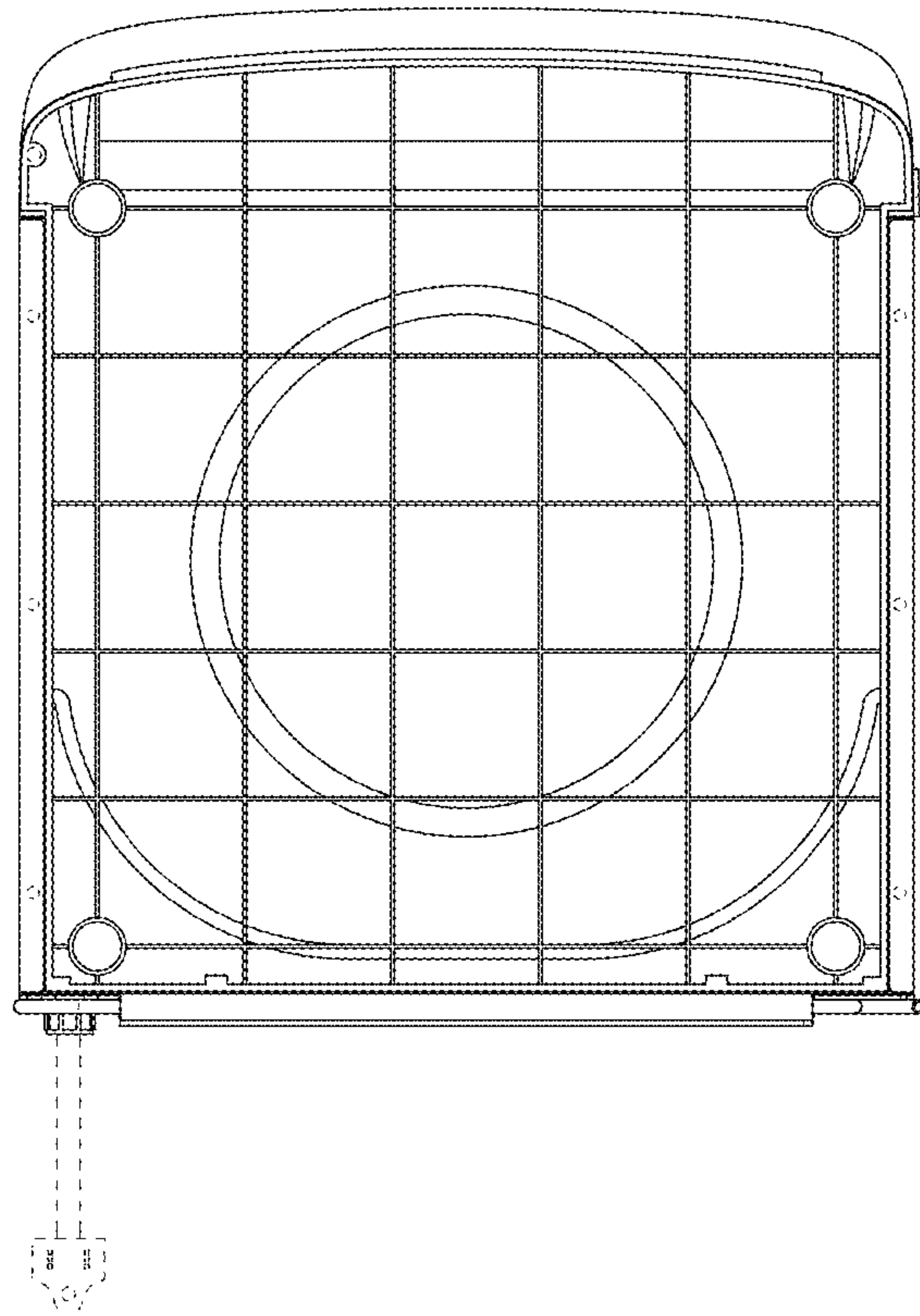

FIG. 8