



US00D948840S

(12) **United States Design Patent** (10) **Patent No.:** **US D948,840 S**  
**Hepler** (45) **Date of Patent:** **\*\* Apr. 19, 2022**

(54) **DUAL MATERIAL PET TREAT**  
(71) Applicant: **POLYSHOT CORPORATION**, West Henrietta, NY (US)  
(72) Inventor: **Douglas Hepler**, Rochester, NY (US)  
(73) Assignee: **POLYSHOT CORPORATION**, West Henrietta, NY (US)

D466,695 S 12/2002 Chen  
6,602,013 B2 8/2003 Clark  
D499,226 S 12/2004 Axelrod  
D503,998 S 4/2005 Axelrod  
D531,365 S \* 10/2006 Axelrod ..... D30/160  
D531,383 S 11/2006 Dettmer et al.  
D584,476 S 1/2009 Caudill  
7,490,579 B2 2/2009 Axelrod  
(Continued)

(\*\*) Term: **15 Years**  
(21) Appl. No.: **35/001,658**

**FOREIGN PATENT DOCUMENTS**

BE 893448 10/1982  
JP 4869557 B2 2/2012  
WO WO-03/088740 A1 10/2003

(22) Filed: **Mar. 18, 2019**

**OTHER PUBLICATIONS**

(80) **Hague Agreement Data**  
Int. Filing Date: **Mar. 18, 2019**  
Int. Reg. No.: **DM/209473**  
Int. Reg. Date: **Mar. 18, 2019**  
Int. Reg. Pub. Date: **Aug. 7, 2020**

“Fresh,” Rolls Rocky Natural Italian Treats for Your Pet, Website Excerpt from <https://rollsrocky.com/en/prodotti/fresh> (accessed Oct. 13, 2019).

(Continued)

(51) **LOC (13) Cl.** ..... **01-01**  
(52) **U.S. Cl.**  
USPC ..... **D1/199**

*Primary Examiner* — Khawaja Anwar  
(74) *Attorney, Agent, or Firm* — Sunit Talapatra; Foley & Lardner LLP

(58) **Field of Classification Search**  
USPC ..... D1/100–130  
CPC ..... A23L 27/84; A23L 29/035; A23L 29/25;  
A23L 2/52; A23L 33/10; A23L 33/105;  
A23L 33/115; A23L 33/15; A23L 3/44  
See application file for complete search history.

(57) **CLAIM**

I claim the ornamental design for a dual material pet treat, as shown and described.

**DESCRIPTION**

(56) **References Cited**  
U.S. PATENT DOCUMENTS

2,095,741 A 11/1935 Hachman  
4,471,506 A 9/1984 Massari  
5,200,212 A 4/1993 Axelrod  
5,263,436 A 11/1993 Axelrod  
5,675,859 A 10/1997 Barre  
D404,495 S 1/1999 Chien  
6,405,681 B1 6/2002 Ward  
6,455,083 B1 9/2002 Wang  
6,474,268 B1 11/2002 Suchowski et al.

FIG. 1.1 is a perspective view of a dual material pet treat showing my new design;  
FIG. 1.2 is a top view thereof;  
FIG. 1.3 is a rear view thereof;  
FIG. 1.4 is a front view thereof;  
FIG. 1.5 is a back view thereof;  
FIG. 1.6 is a left side view thereof; and  
FIG. 1.7 is a right side view thereof.  
The broken lines in the drawings depict portions of the dual material pet treat that form no part of the claimed design.

**1 Claim, 6 Drawing Sheets**

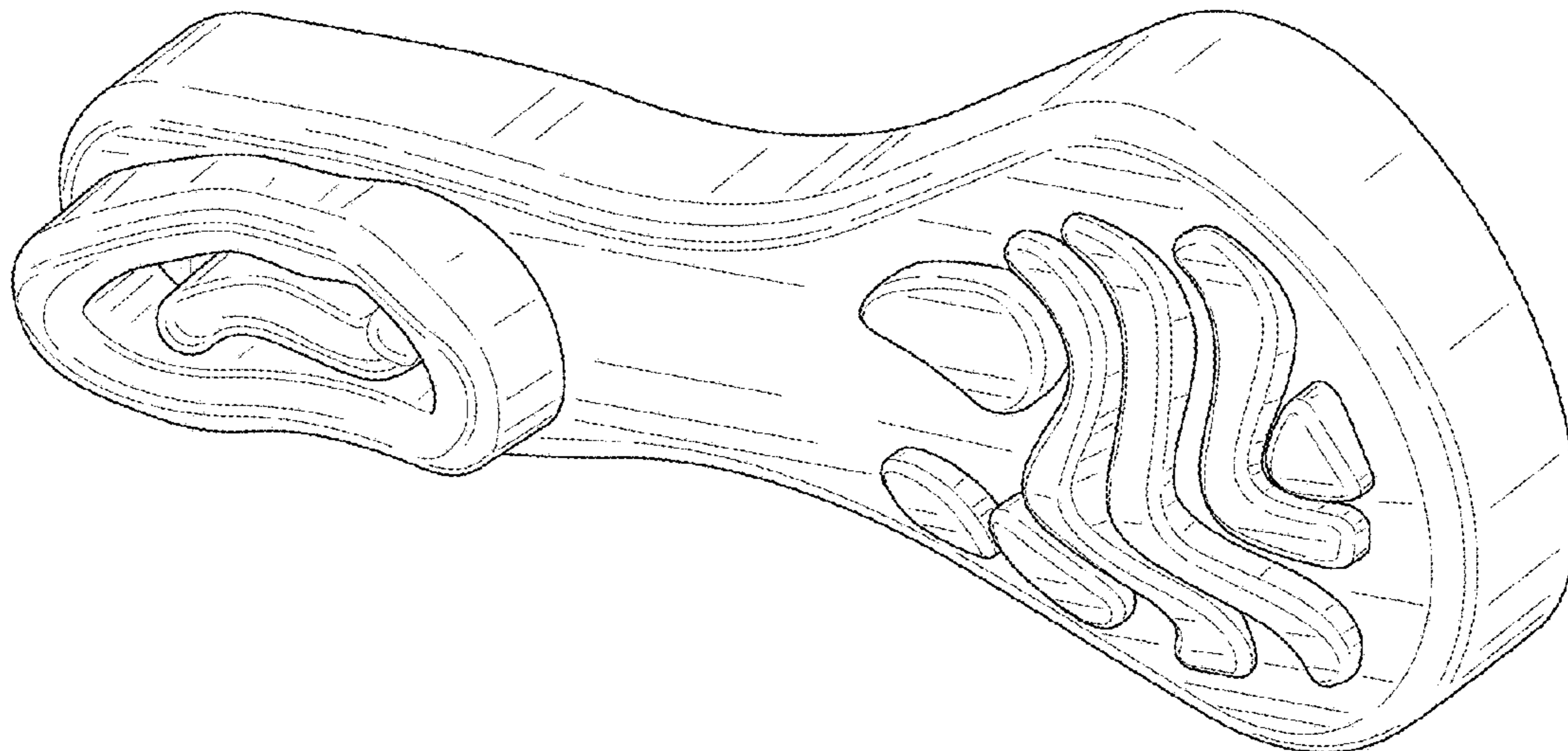

(56)

**References Cited**

U.S. PATENT DOCUMENTS

D587,428	S	3/2009	Torney et al.	
7,497,189	B2	3/2009	Torney et al.	
D590,127	S *	4/2009	Caudill .....	D1/125
D603,127	S	11/2009	Townsend et al.	
D636,948	S *	4/2011	Axelrod .....	D30/160
7,947,894	B2	5/2011	Nakata	
8,367,144	B2	2/2013	Pater et al.	
D684,746	S	6/2013	Pang	
D715,016	S	10/2014	Huang	
D740,518	S *	10/2015	Axelrod .....	D1/199
D745,241	S	12/2015	Doerr	
D747,067	S	1/2016	Axelrod	
D822,339	S *	7/2018	Wilson .....	D1/199
D822,340	S *	7/2018	Wilson .....	D1/199
D849,355	S	5/2019	Guo et al.	
D861,283	S *	10/2019	Axelrod .....	D1/199
D903,227	S *	12/2020	Baikie .....	D1/106
D909,708	S *	2/2021	Hao .....	D1/199
2007/0101946	A1	5/2007	Penny	
2008/0041320	A1	2/2008	Torney et al.	
2008/0201881	A1	8/2008	Dunn et al.	
2012/0279460	A1 *	11/2012	Pang .....	A01K 15/026 119/709

OTHER PUBLICATIONS

Notice of Allowance in U.S. Appl. No. 35/001,421 dated Aug. 16, 2019.

Notice of Allowance on U.S. Appl. No. 29/703,225 dated Jul. 24, 2020.

\* cited by examiner

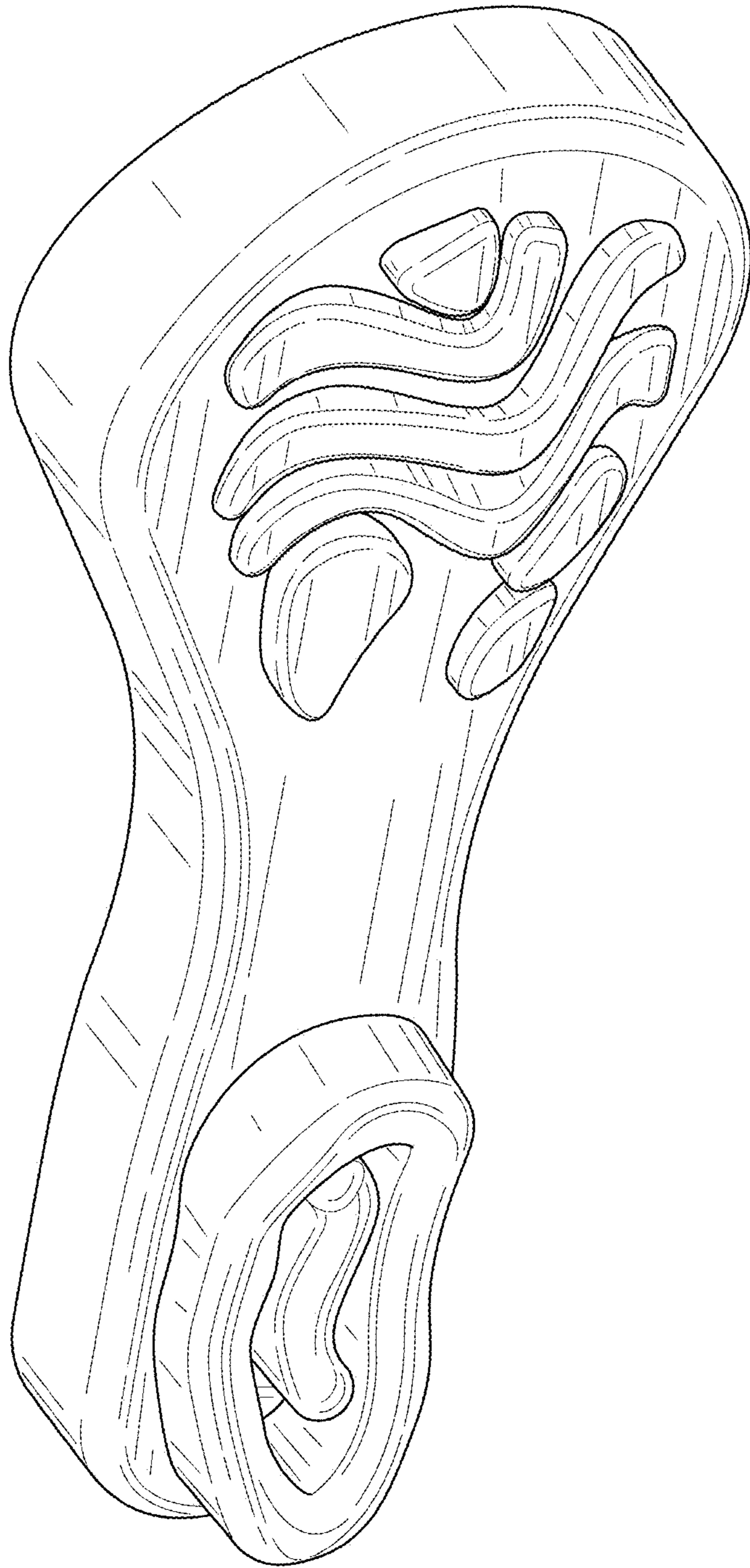

11

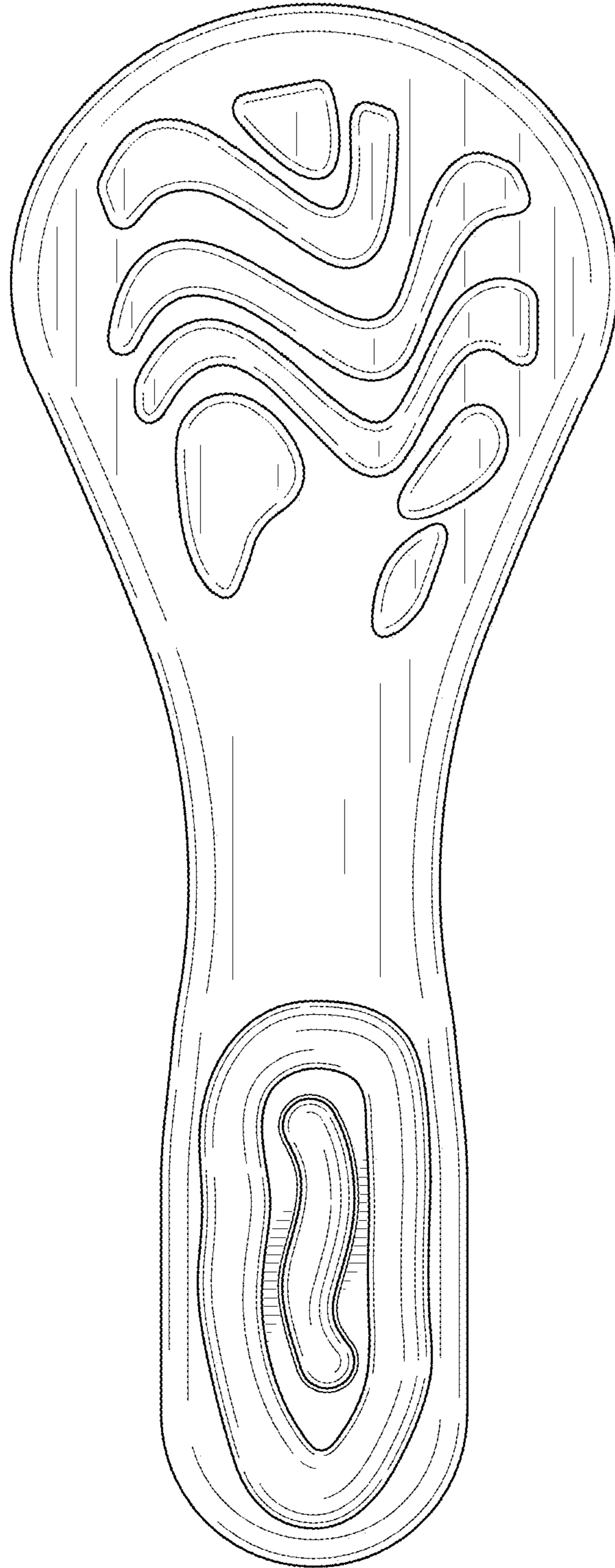

1.2

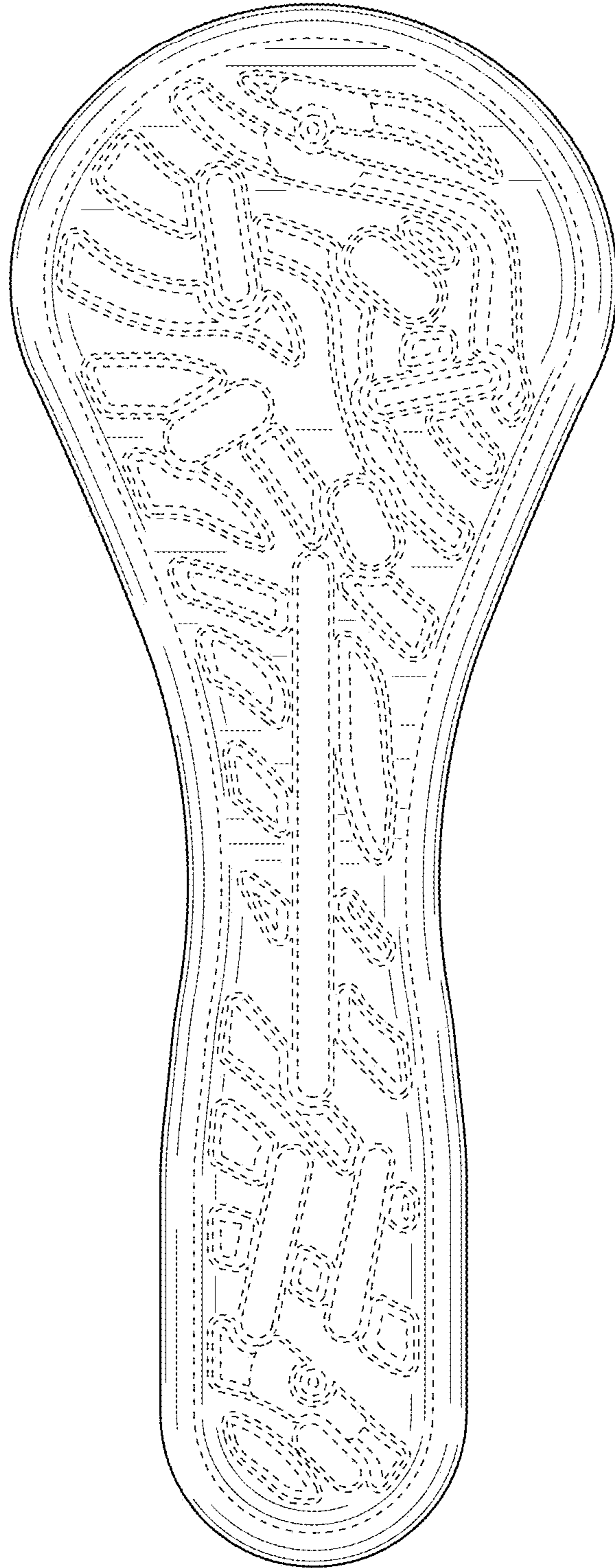

1.3

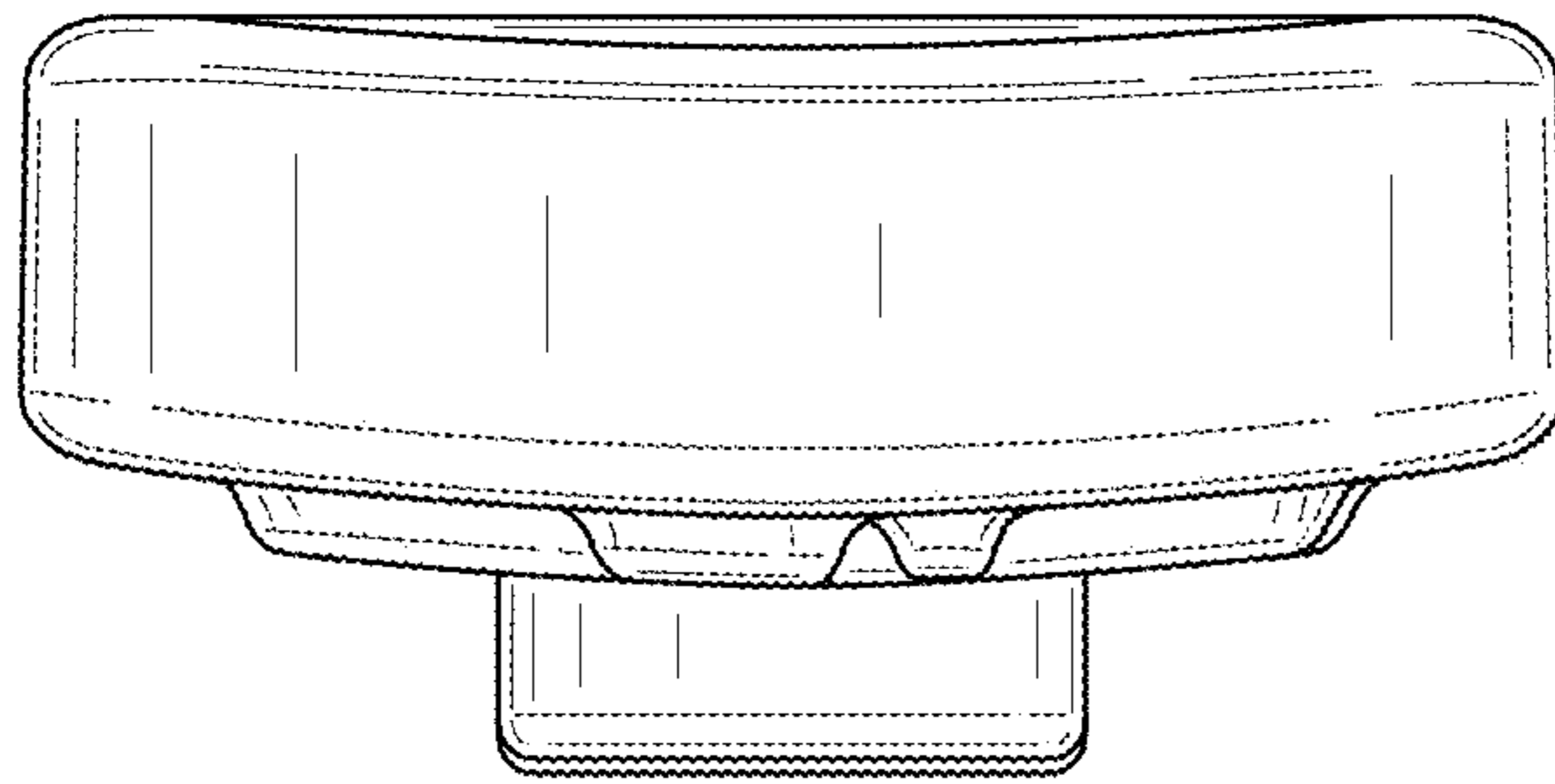

1.5

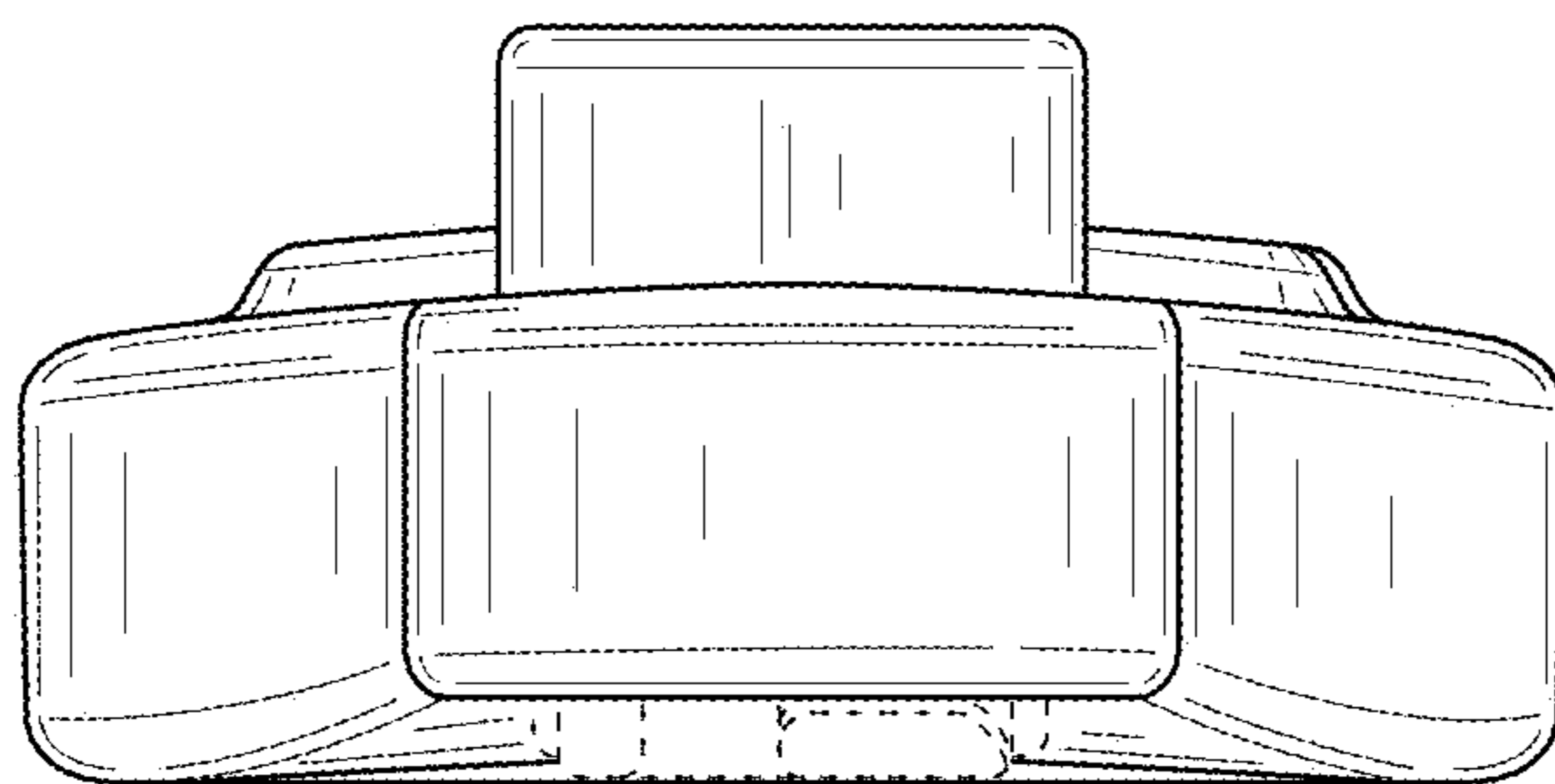

1.4

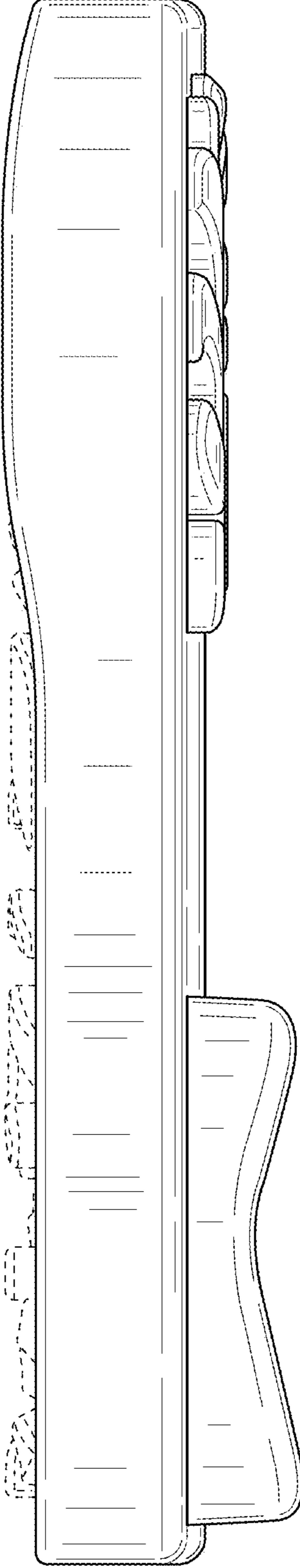

1.6

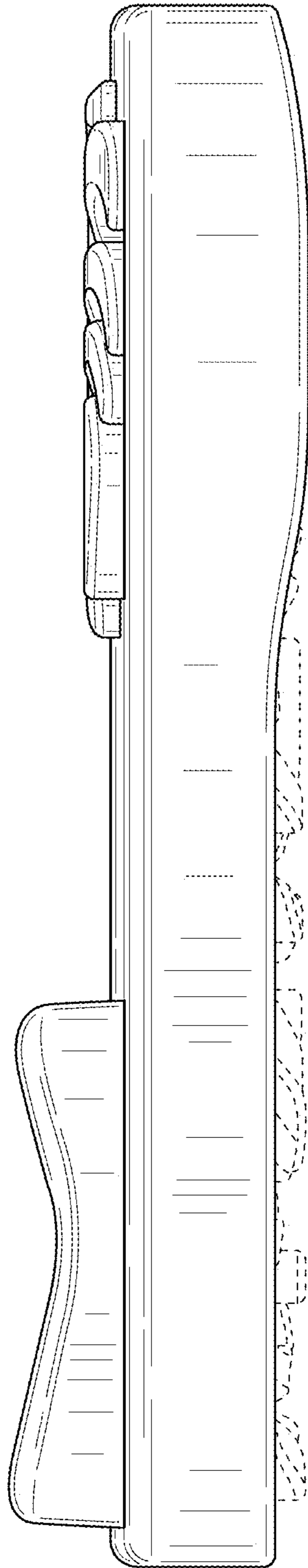

1.7