



US00D948838S

(12) **United States Design Patent**  
**Hernandez et al.**

(10) **Patent No.:** **US D948,838 S**  
(45) **Date of Patent:** **\*\* Apr. 19, 2022**

(54) **CONFECTIONERY**

(71) Applicant: **INTERCONTINENTAL GREAT BRANDS LLC**, East Hanover, NJ (US)

(72) Inventors: **Dante Manuel Hernandez**, Tlanepantla de Baz (MX); **Victoria Juárez**, Tlanepantla de Baz (MX)

(73) Assignee: **INTERCONTINENTAL GREAT BRANDS LLC**, East Hanover, NJ (US)

(\*\*) Term: **15 Years**

(21) Appl. No.: **29/743,386**

(22) Filed: **Jul. 21, 2020**

**Related U.S. Application Data**

(63) Continuation of application No. 29/734,500, filed on May 13, 2020.

(51) **LOC (13) Cl.** ..... **01-01**

(52) **U.S. Cl.**  
USPC ..... **D1/104; D1/127**

(58) **Field of Classification Search**  
USPC ..... D1/100–130, 199; 426/5, 104, 249, 275, 426/660, 549, 512; D24/101–104;  
(Continued)

(56) **References Cited**

**U.S. PATENT DOCUMENTS**

D62,611 S \* 7/1923 Hochstraser ..... D1/104  
D224,549 S \* 8/1972 Kroll ..... D21/458  
(Continued)

**OTHER PUBLICATIONS**

“Limited Edition Maynards Sour Patch Kids Head & Bodies.” Grocery Gems. Oct. 17, 2013. Web. Jun. 2, 2021. <<http://grocerygems.blogspot.com/2013/10/limited-edition-maynards-sour-patch.html>>.\*

*Primary Examiner* — Katie Jane Stofko

(74) *Attorney, Agent, or Firm* — Cantor Colburn LLP

(57) **CLAIM**

We claim, the ornamental design for a confectionery, as shown and described.

**DESCRIPTION**

FIG. 1 is a perspective view of a confectionery, showing our new design in a first embodiment;

FIG. 2 is a front view of the embodiment shown in FIG. 1;

FIG. 3 is a rear view of the embodiment shown in FIG. 1;

FIG. 4 is a right side view of the embodiment shown in FIG. 1;

FIG. 5 is a left side view of the embodiment shown in FIG. 1;

FIG. 6 is a top view of the embodiment shown in FIG. 1;

FIG. 7 is a bottom view of the embodiment shown in FIG. 1;

FIG. 8 is a perspective view of a confectionery, showing our new design in a second embodiment;

FIG. 9 is a front view of the embodiment shown in FIG. 8;

FIG. 10 is a rear view of the embodiment shown in FIG. 8;

FIG. 11 is a right side view of the embodiment shown in FIG. 8;

FIG. 12 is a left side view of the embodiment shown in FIG. 8;

FIG. 13 is a top view of the embodiment shown in FIG. 8;

FIG. 14 is a bottom view of the embodiment shown in FIG. 8;

FIG. 15 is a perspective view of a confectionery, showing our new design in a third embodiment;

FIG. 16 is a front view of the embodiment shown in FIG. 15;

FIG. 17 is a rear view of the embodiment shown in FIG. 15;

FIG. 18 is a right side view of the embodiment shown in FIG. 15;

FIG. 19 is a left side view of the embodiment shown in FIG. 15;

FIG. 20 is a top view of the embodiment shown in FIG. 15;

FIG. 21 is a bottom view of the embodiment shown in FIG. 15;

FIG. 22 is a perspective view of a confectionery, showing our new design in a fourth embodiment;

(Continued)

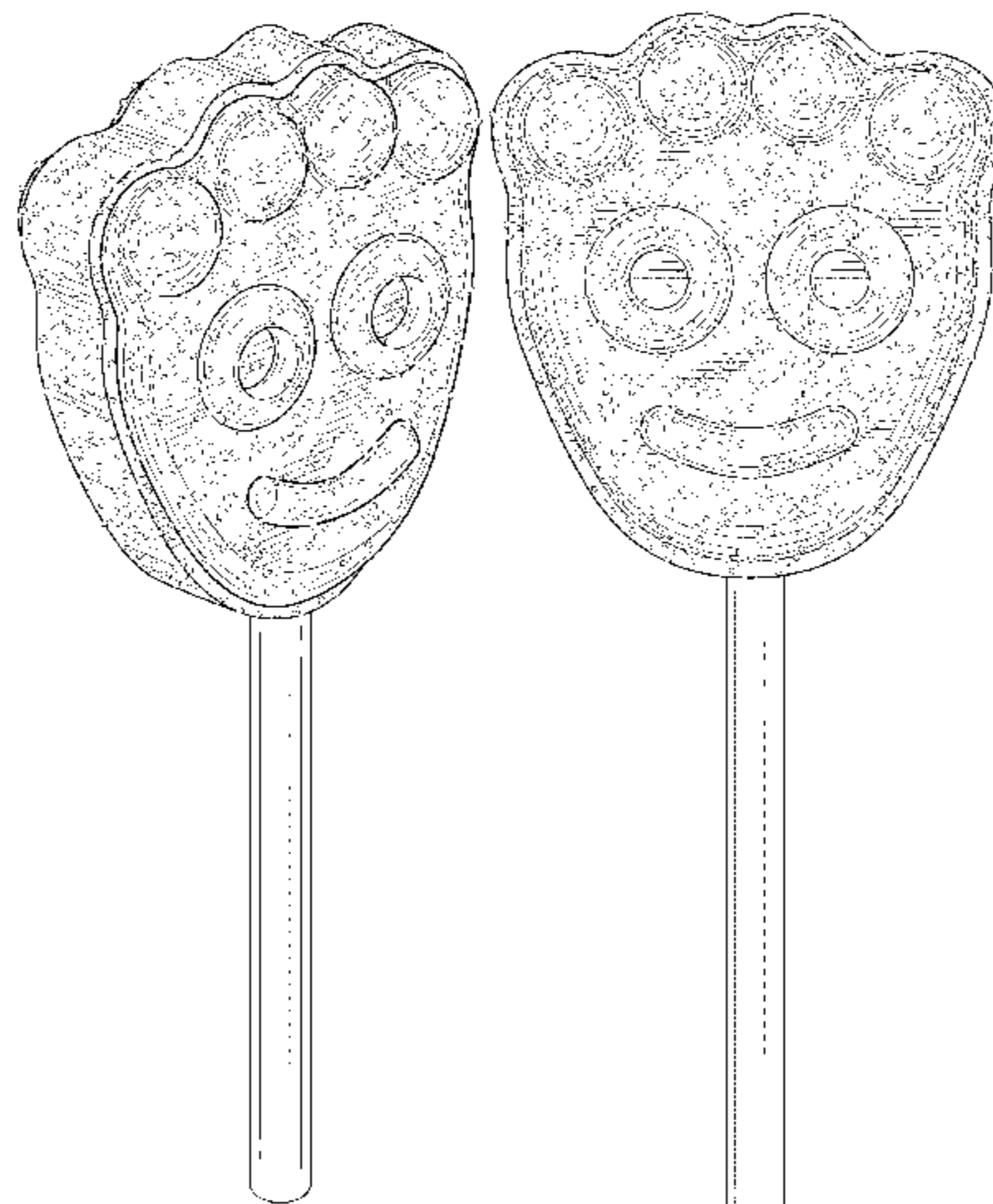

FIG. 23 is a front view of the embodiment shown in FIG. 22; FIG. 24 is a rear view of the embodiment shown in FIG. 22; FIG. 25 is a right side view of the embodiment shown in FIG. 22; FIG. 26 is a left side view of the embodiment shown in FIG. 22; FIG. 27 is a top view of the embodiment shown in FIG. 22; and, FIG. 28 is a bottom view of the embodiment shown in FIG. 22.

The broken lines shown in the drawings illustrate portions of the confectionery that form no part of the claimed design.

**1 Claim, 24 Drawing Sheets**

(58) **Field of Classification Search**

USPC ..... 273/429; D9/707, 714; D28/8.1, 4; D14/433; D11/20, 31  
CPC ... A23G 4/02; A23G 4/06; A23G 4/08; A23G 4/10; A23G 4/20; A23G 4/00; A23G

3/38; A23G 3/42; A23G 3/54; A23G 3/50; A23G 9/48; A23K 1/164; A23V 2002/00

See application file for complete search history.

(56)

**References Cited**

U.S. PATENT DOCUMENTS

D327,154	S	*	6/1992	Raimbert	.....	D1/106
D391,385	S	*	3/1998	Steele	.....	426/104
D490,587	S	*	6/2004	Hunt	.....	D1/102
D517,273	S	*	3/2006	Harrington	.....	D1/108
D598,632	S	*	8/2009	Damron	.....	D1/106
D695,988	S	*	12/2013	Trammell	.....	D1/106
D728,192	S	*	5/2015	Neely	.....	D1/109
D768,351	S	*	10/2016	Sherman	.....	D1/108
D768,352	S	*	10/2016	Sherman	.....	D1/108
D779,150	S	*	2/2017	Sherman	.....	D1/108
2008/0213436	A1	*	9/2008	Mansuino	.....	A23G 1/0066 426/103

\* cited by examiner

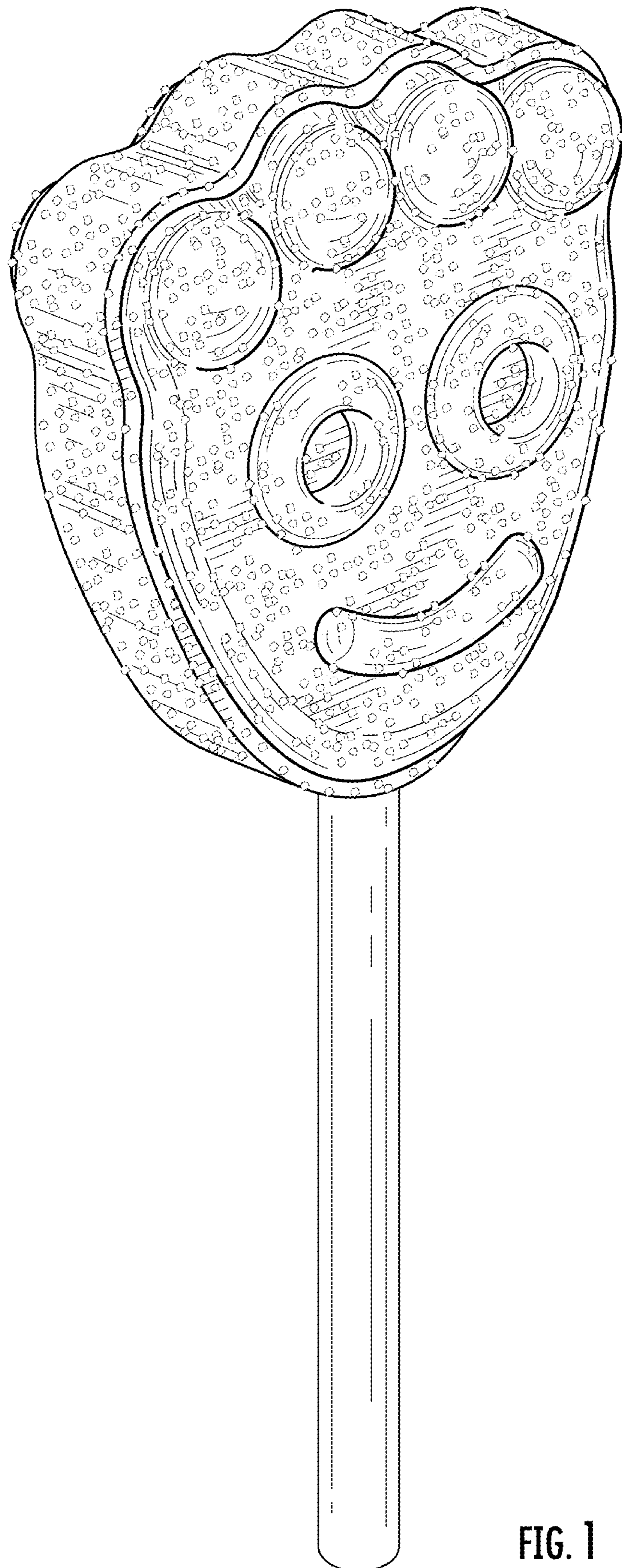

FIG. 1

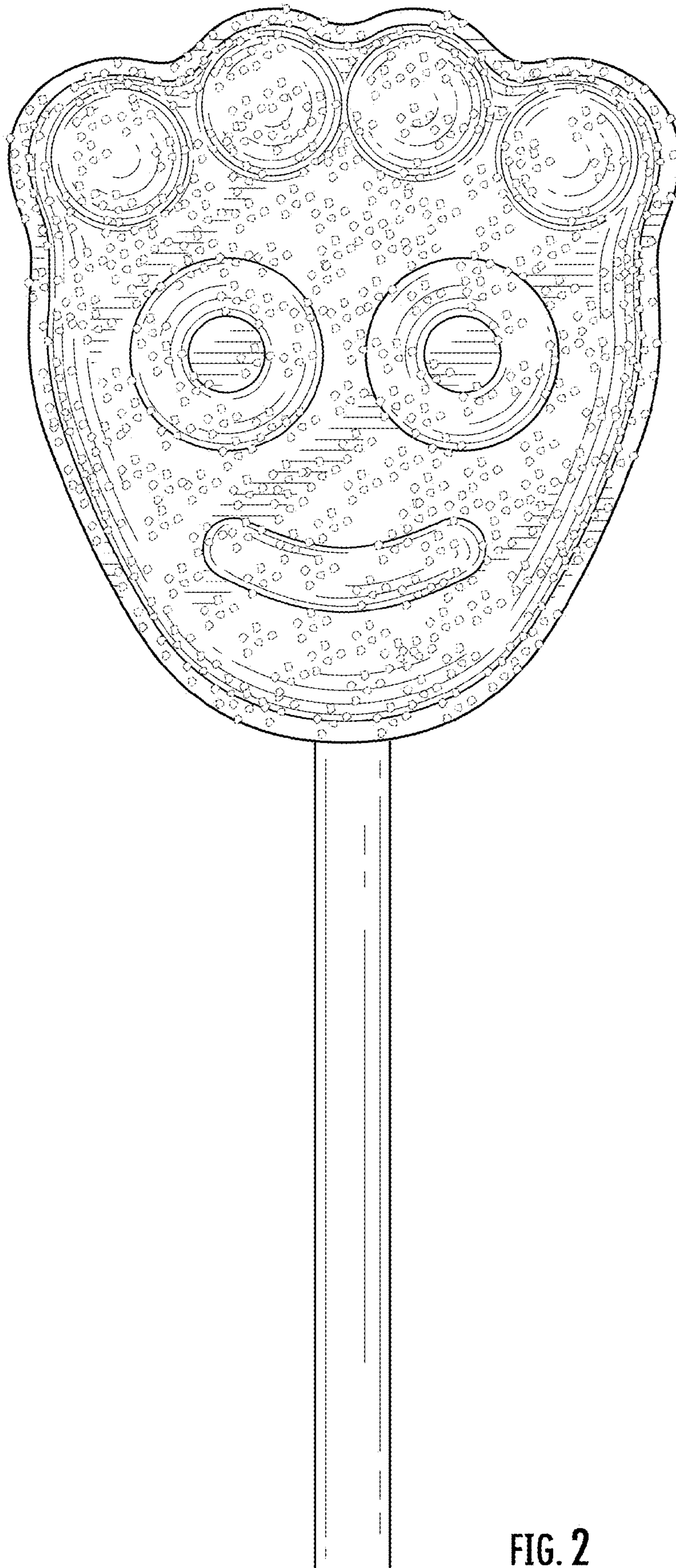

FIG. 2

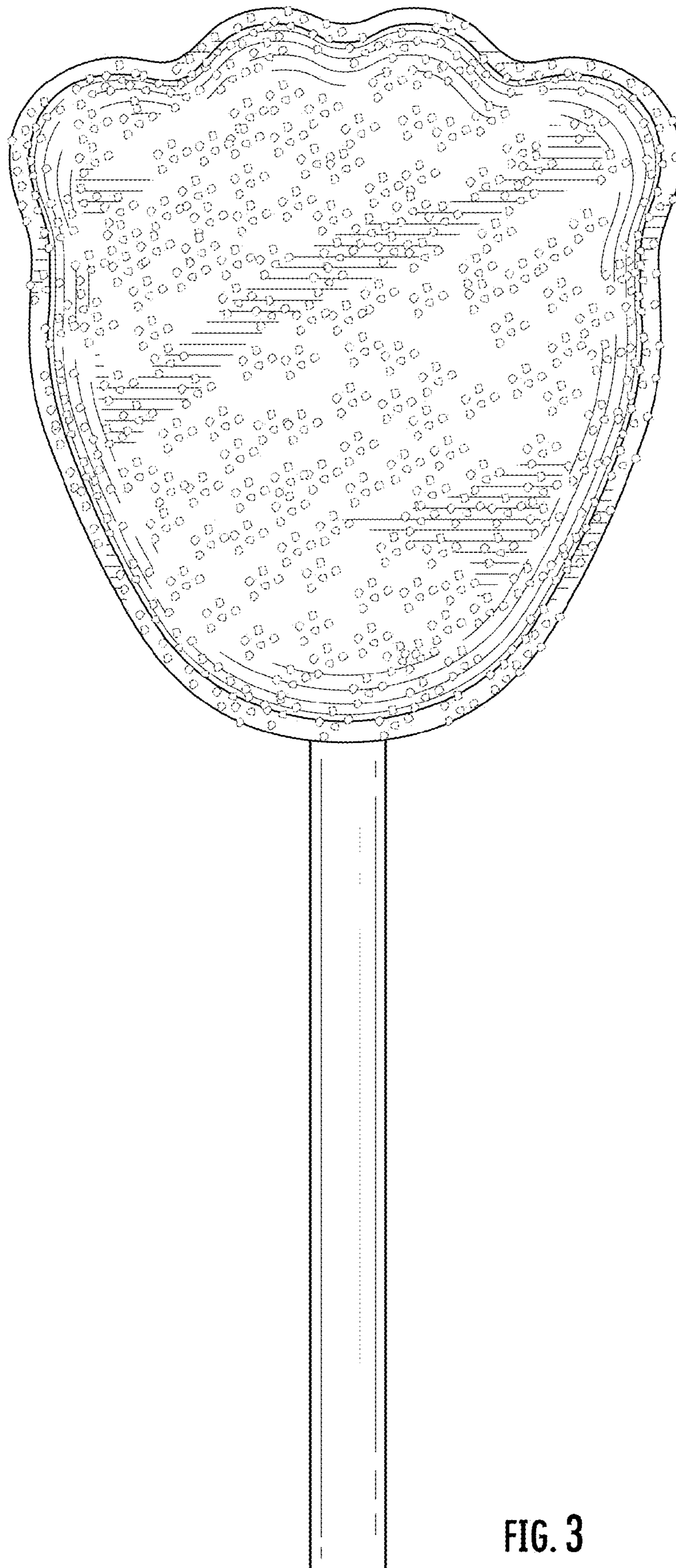

FIG. 3

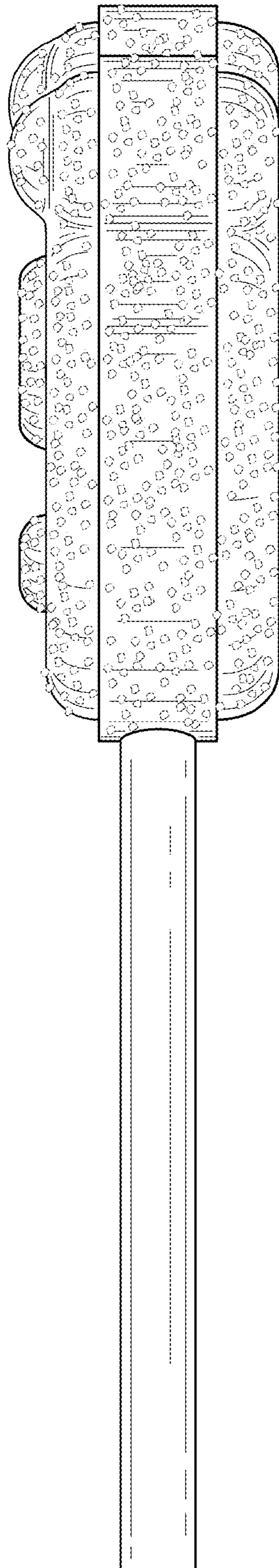

FIG. 4

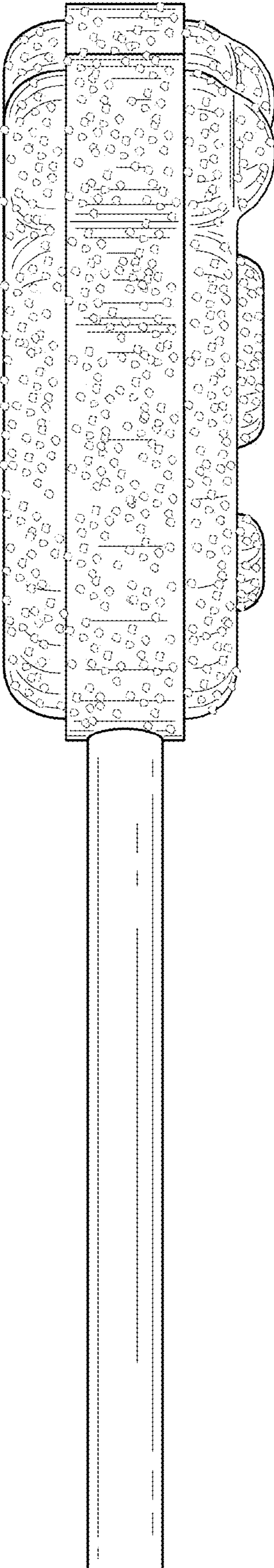

FIG. 5

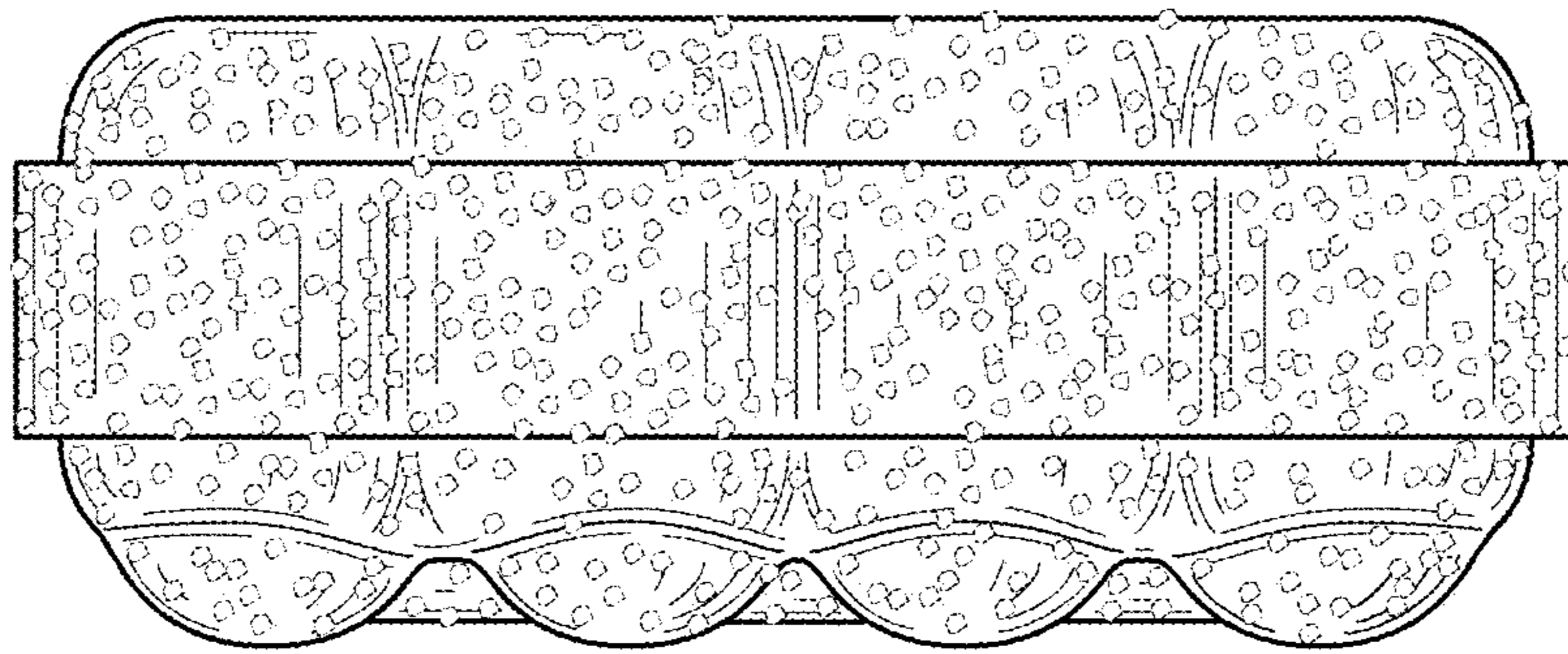

FIG. 6

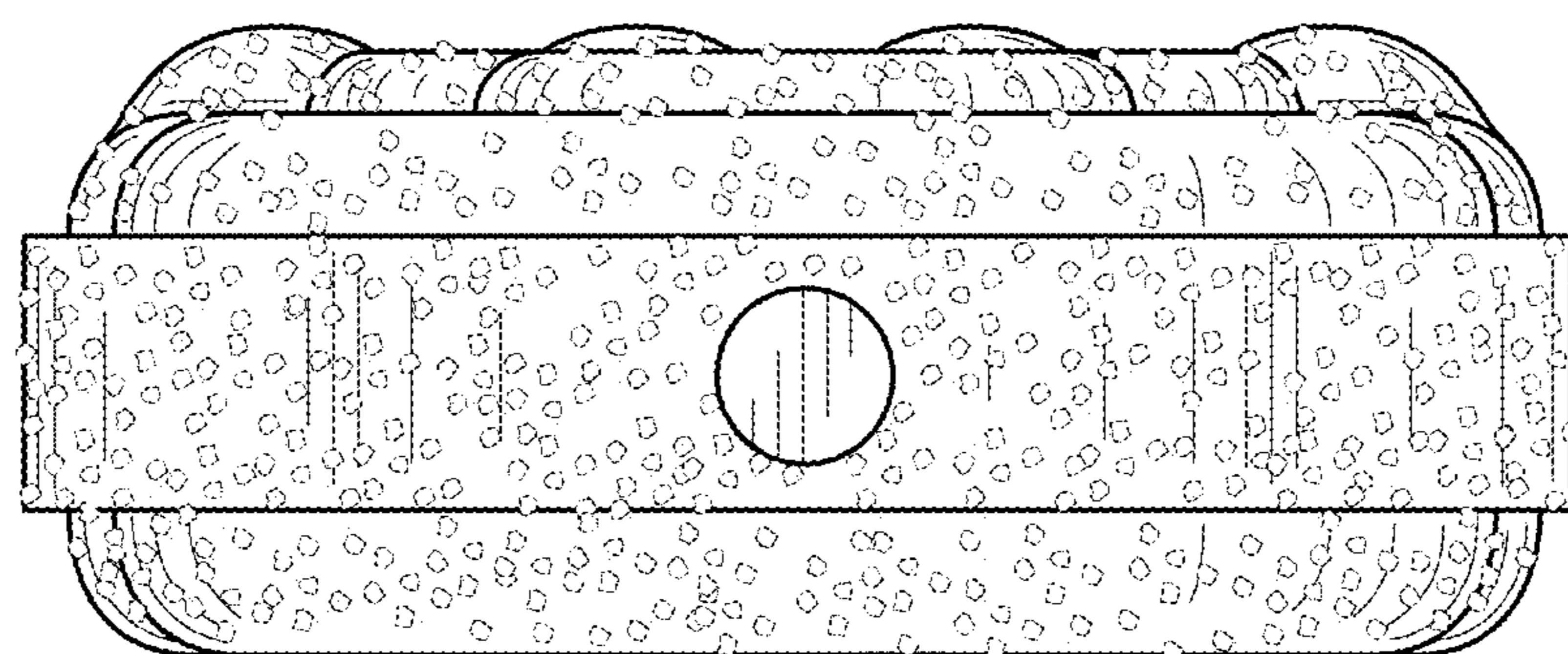

FIG. 7



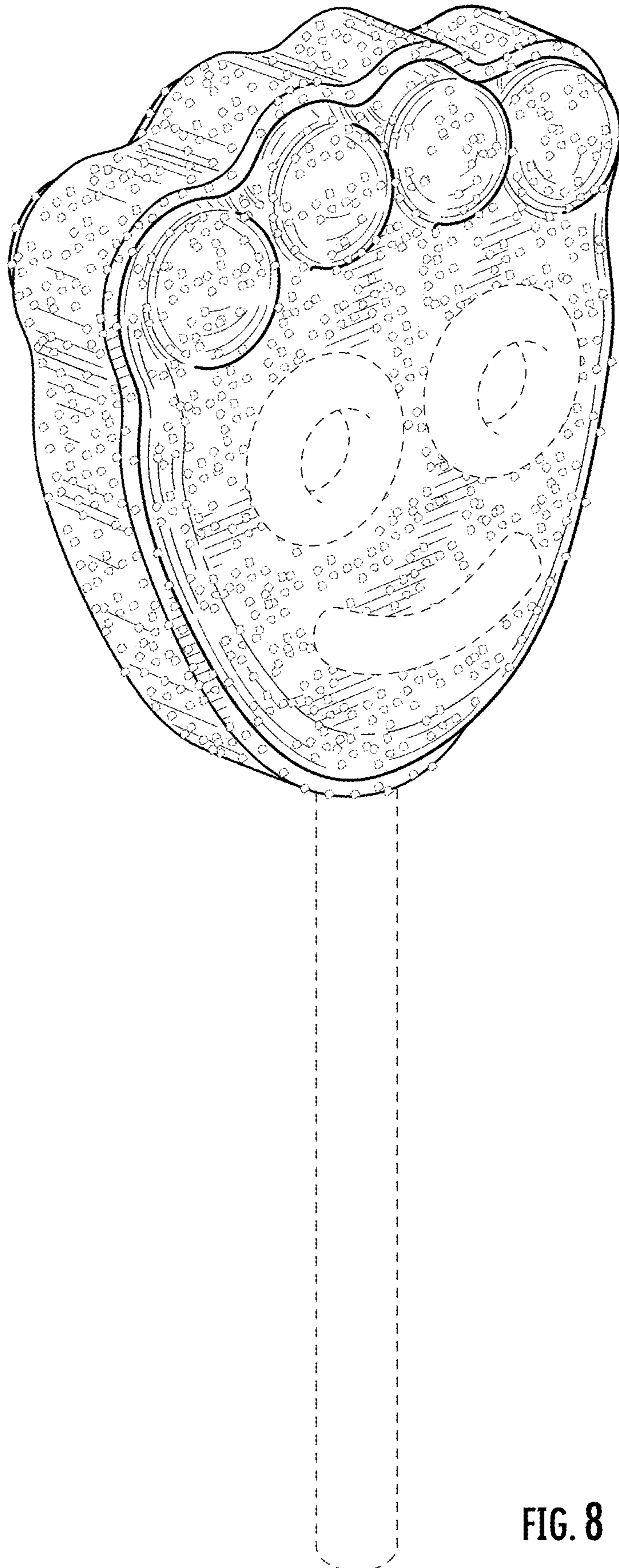

FIG. 8

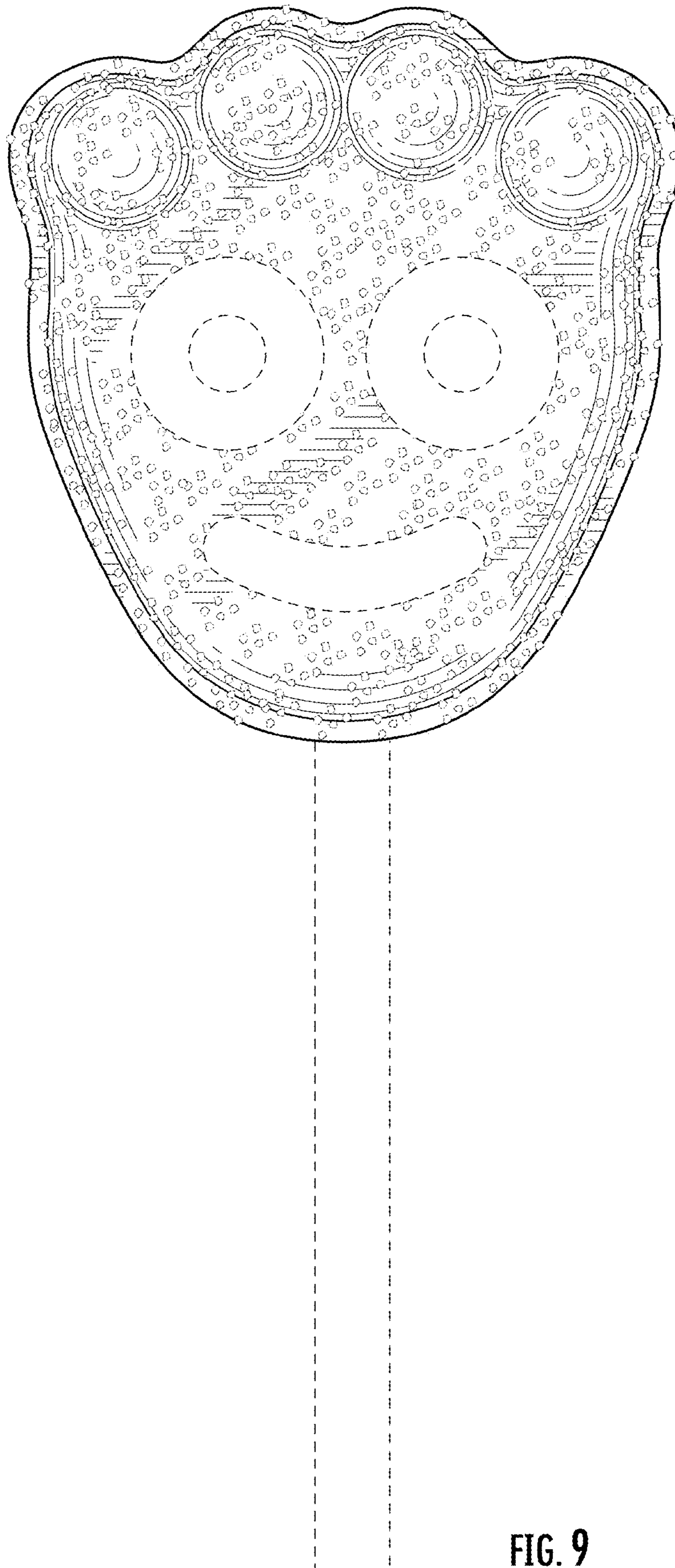

FIG. 9

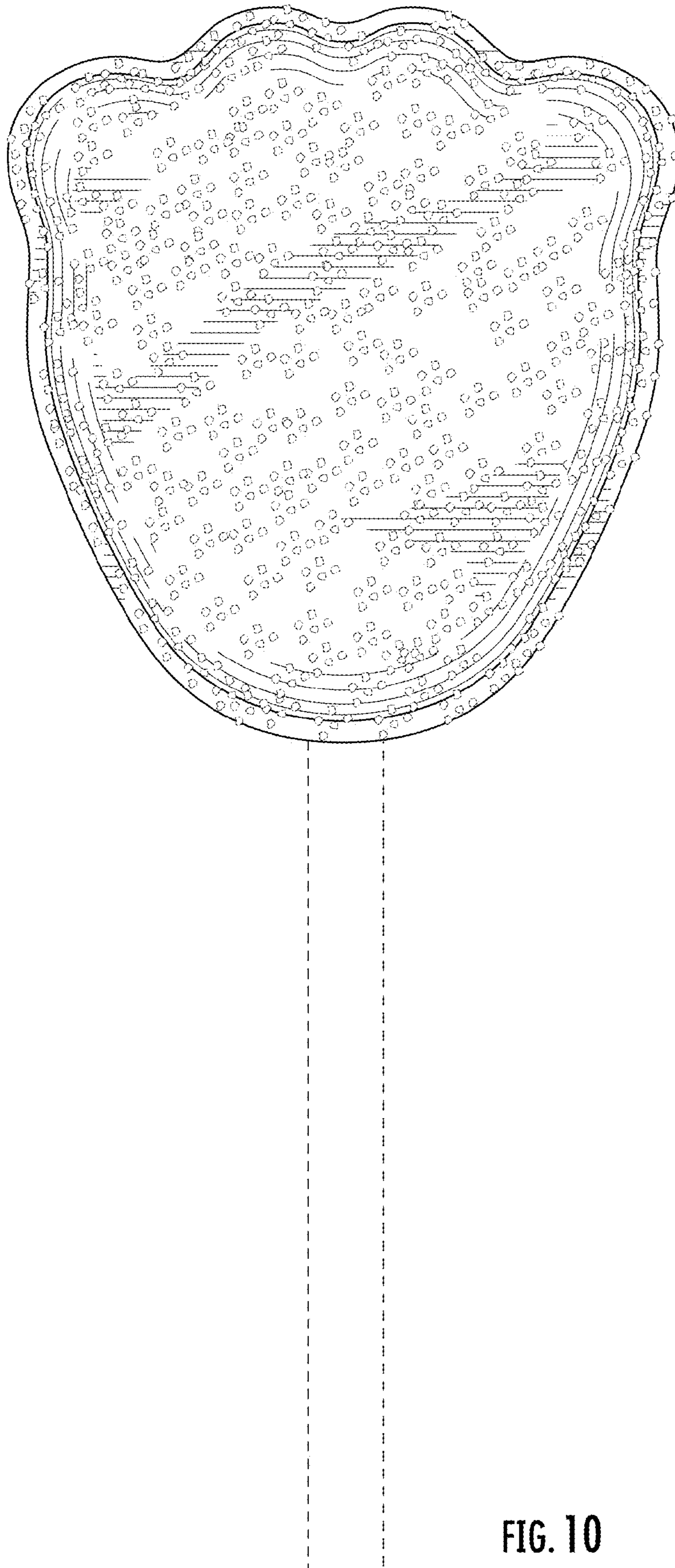

FIG. 10

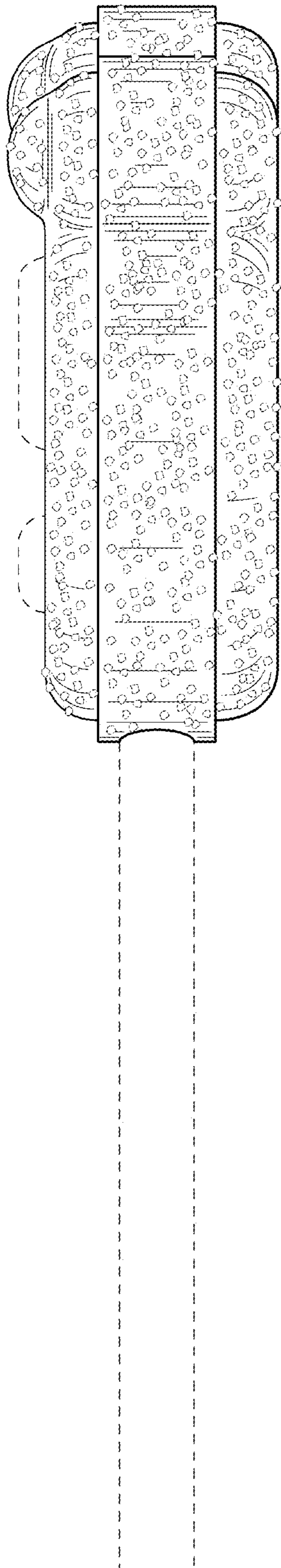

FIG. 11

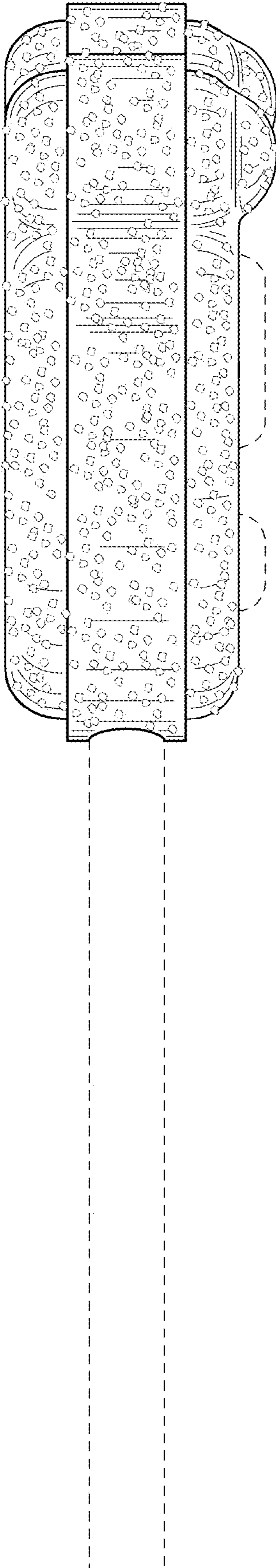

FIG. 12

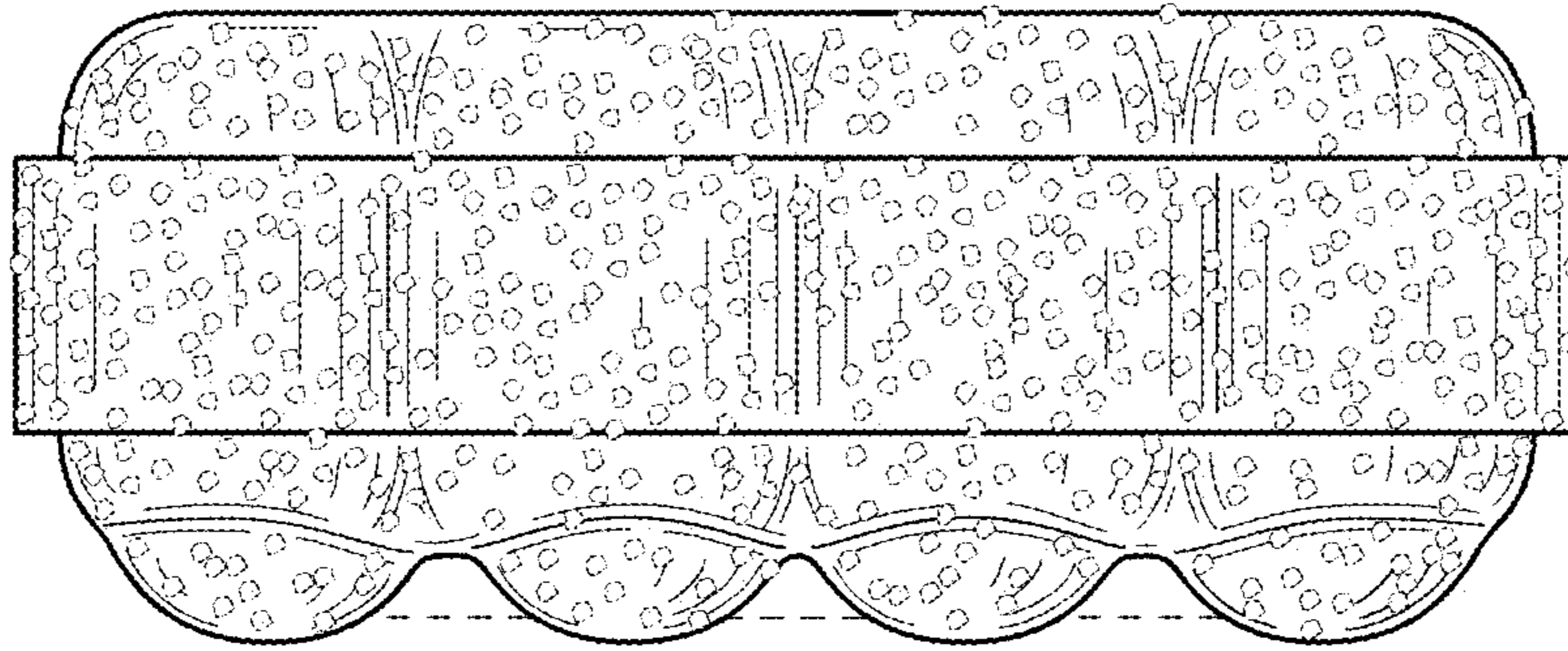

FIG. 13

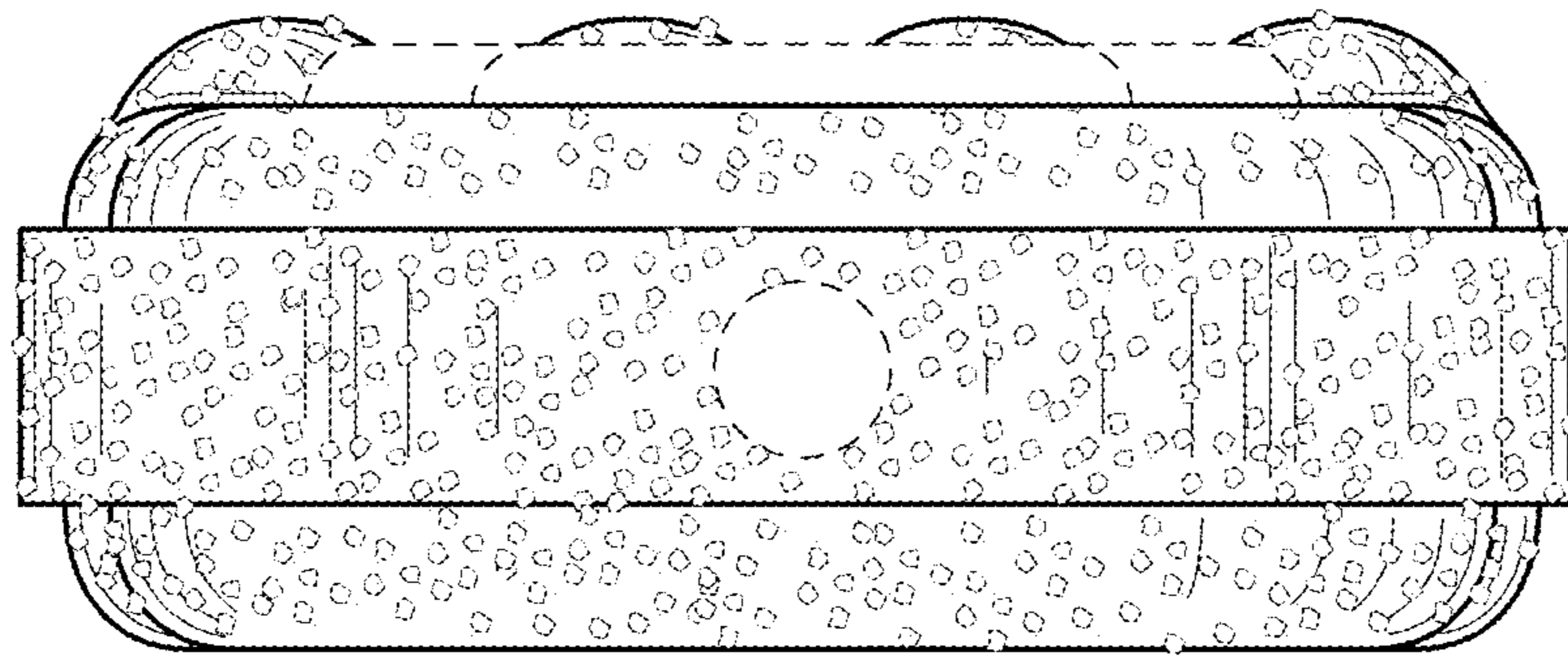

FIG. 14

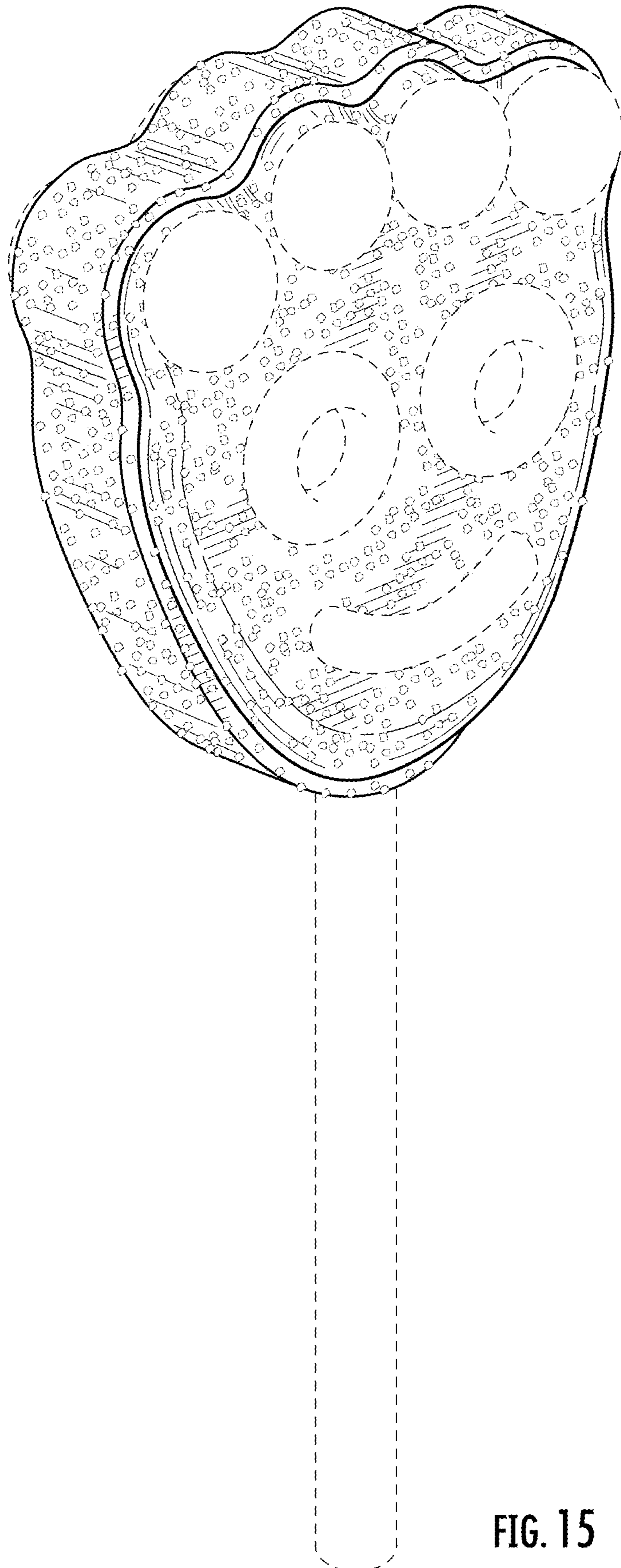

FIG. 15

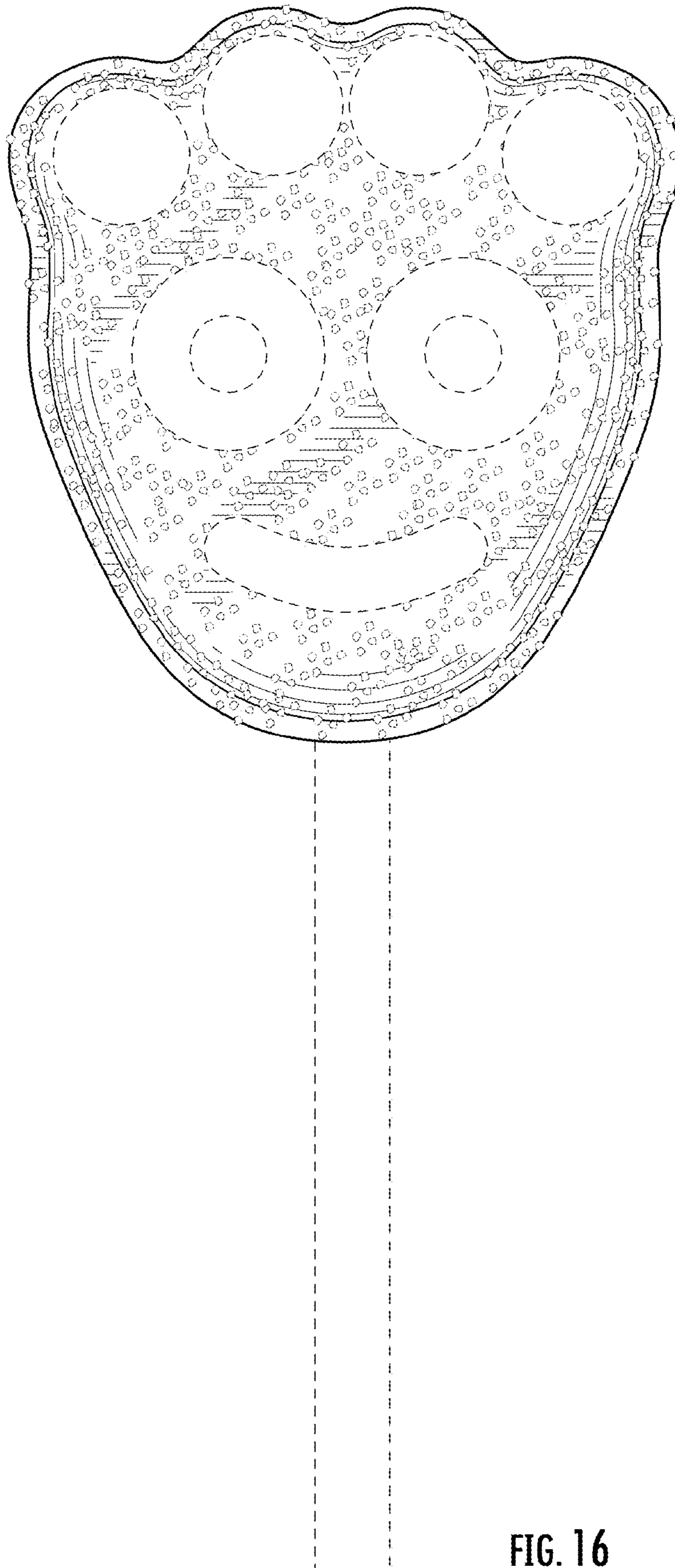

FIG. 16



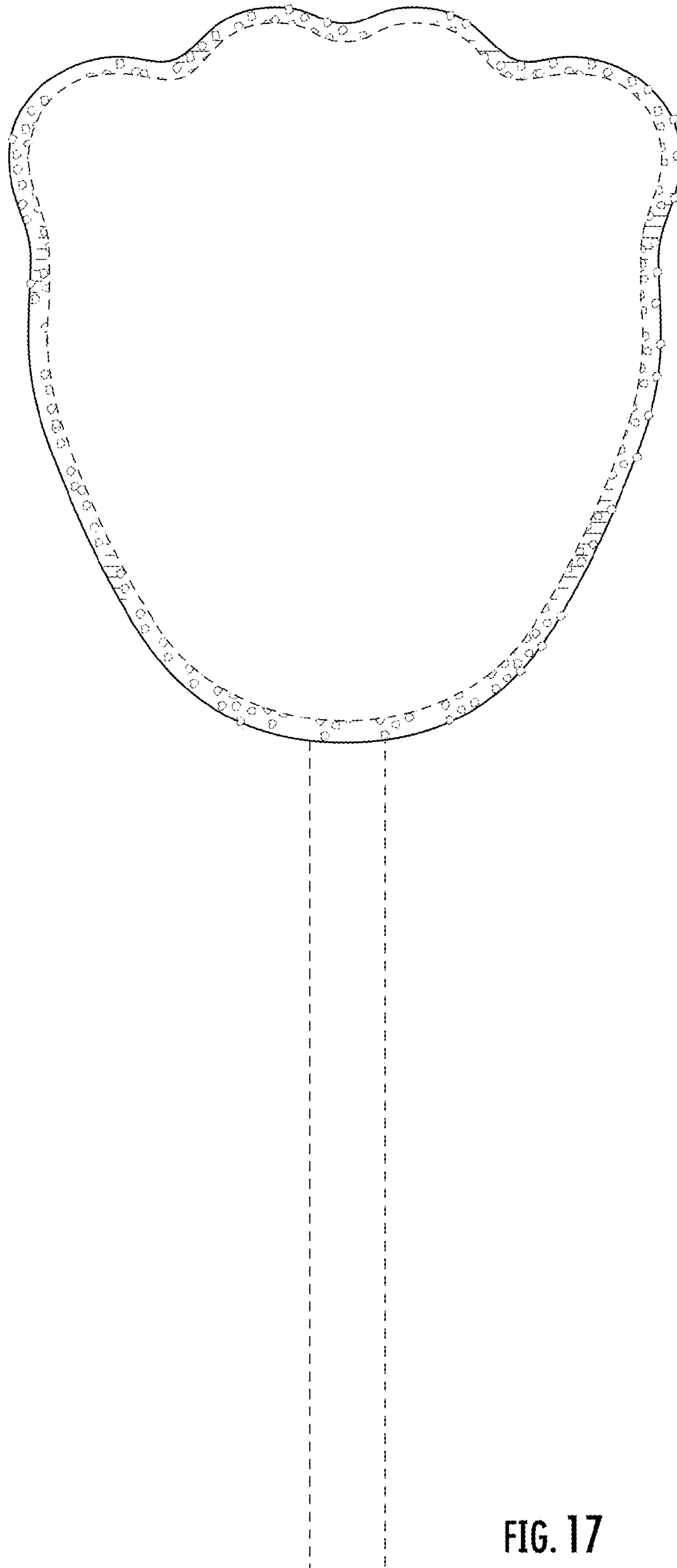

FIG. 17

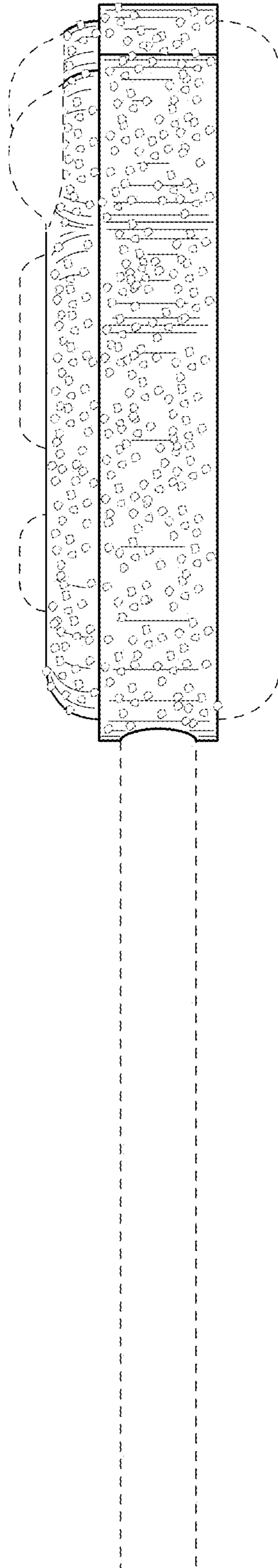

FIG. 18

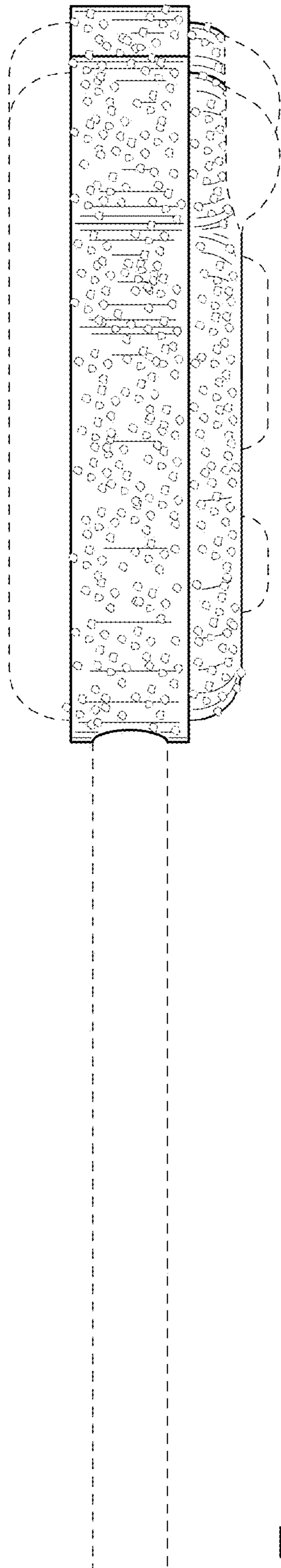

FIG. 19

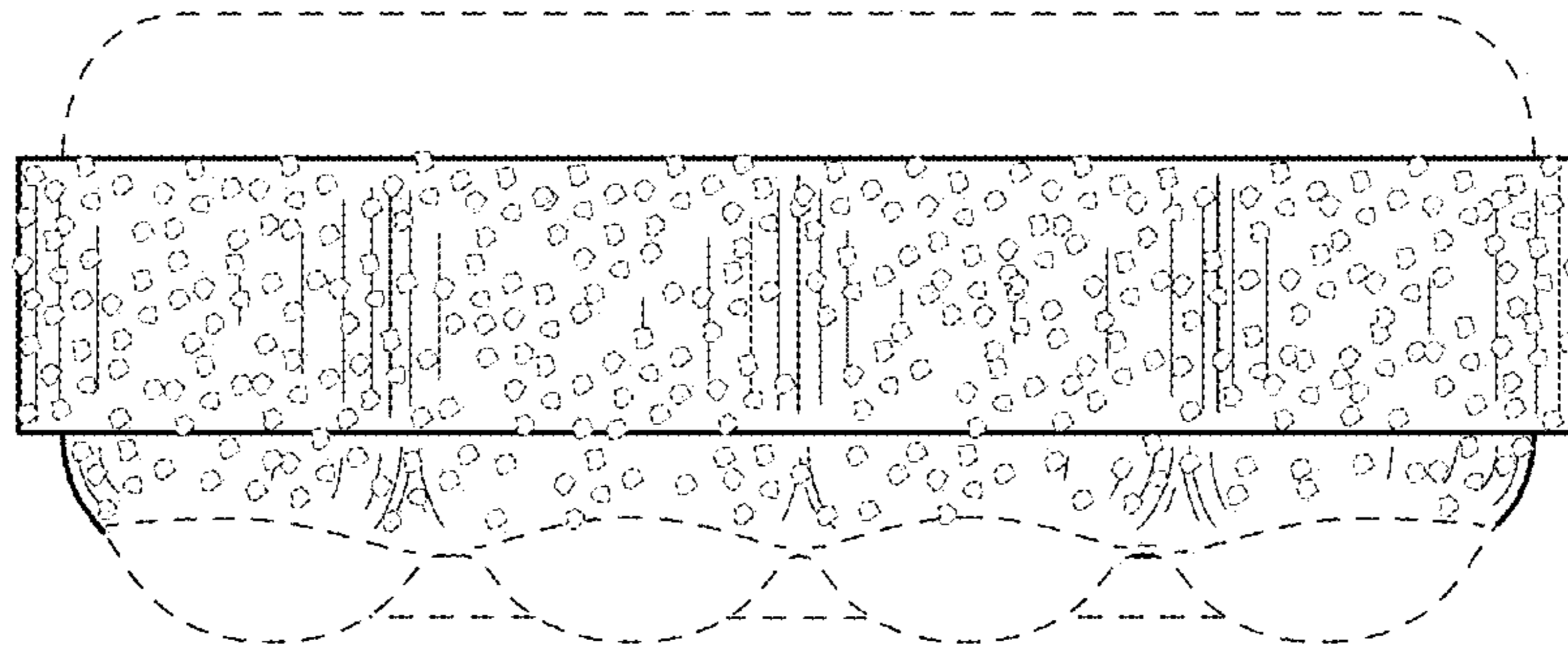

FIG. 20

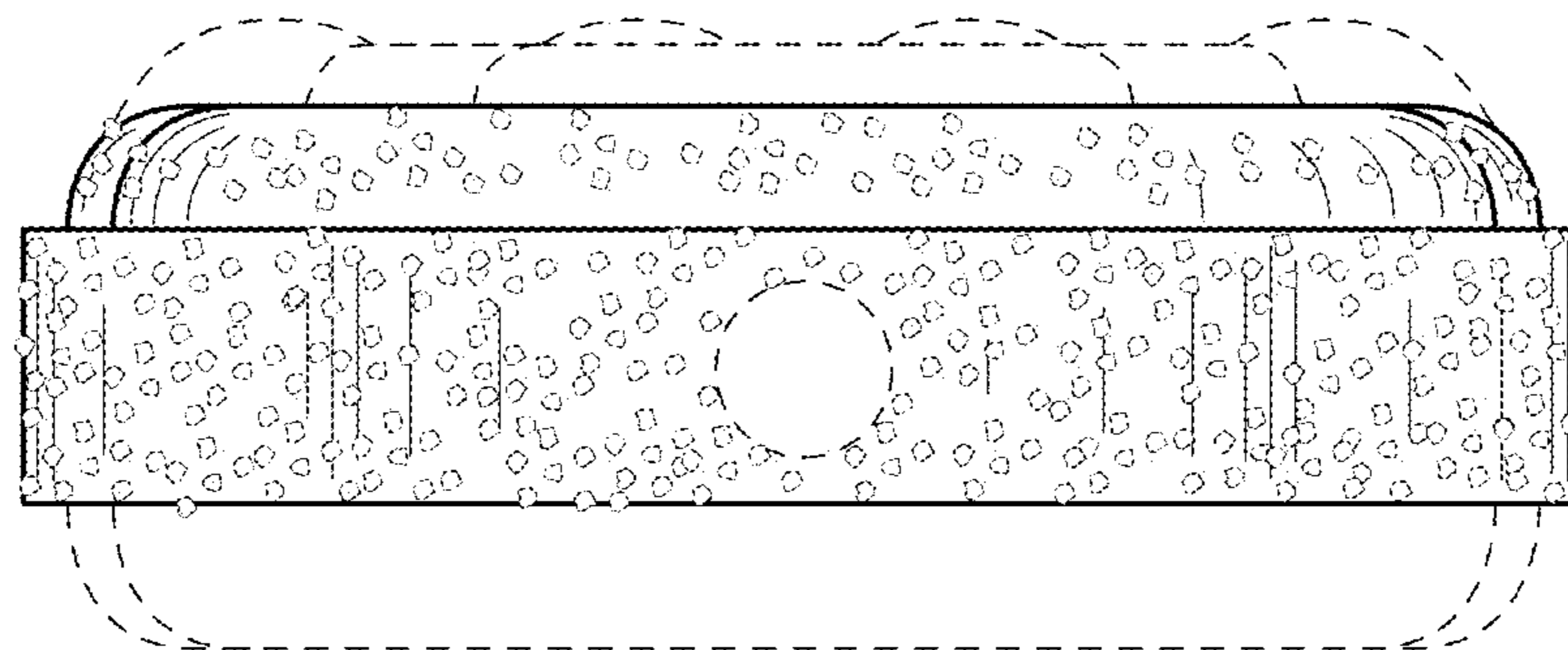

FIG. 21

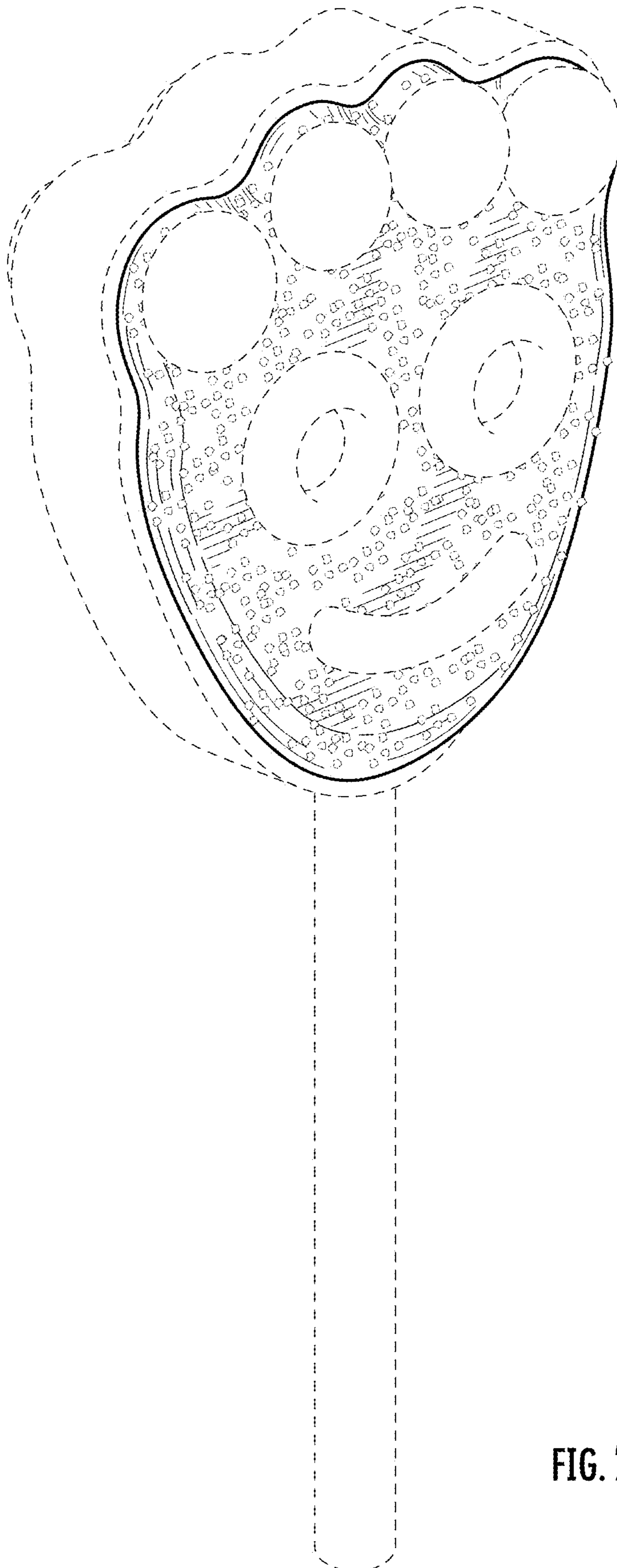

FIG. 22

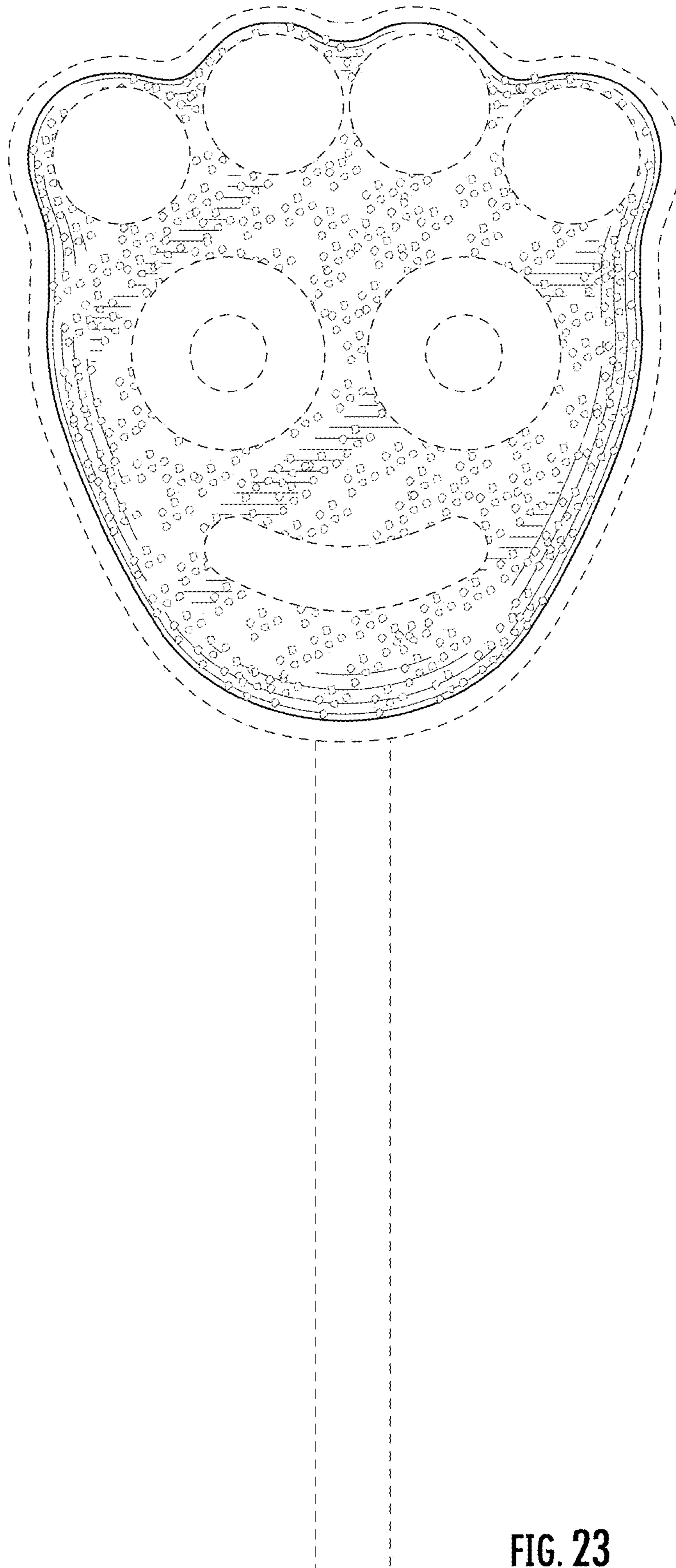

FIG. 23

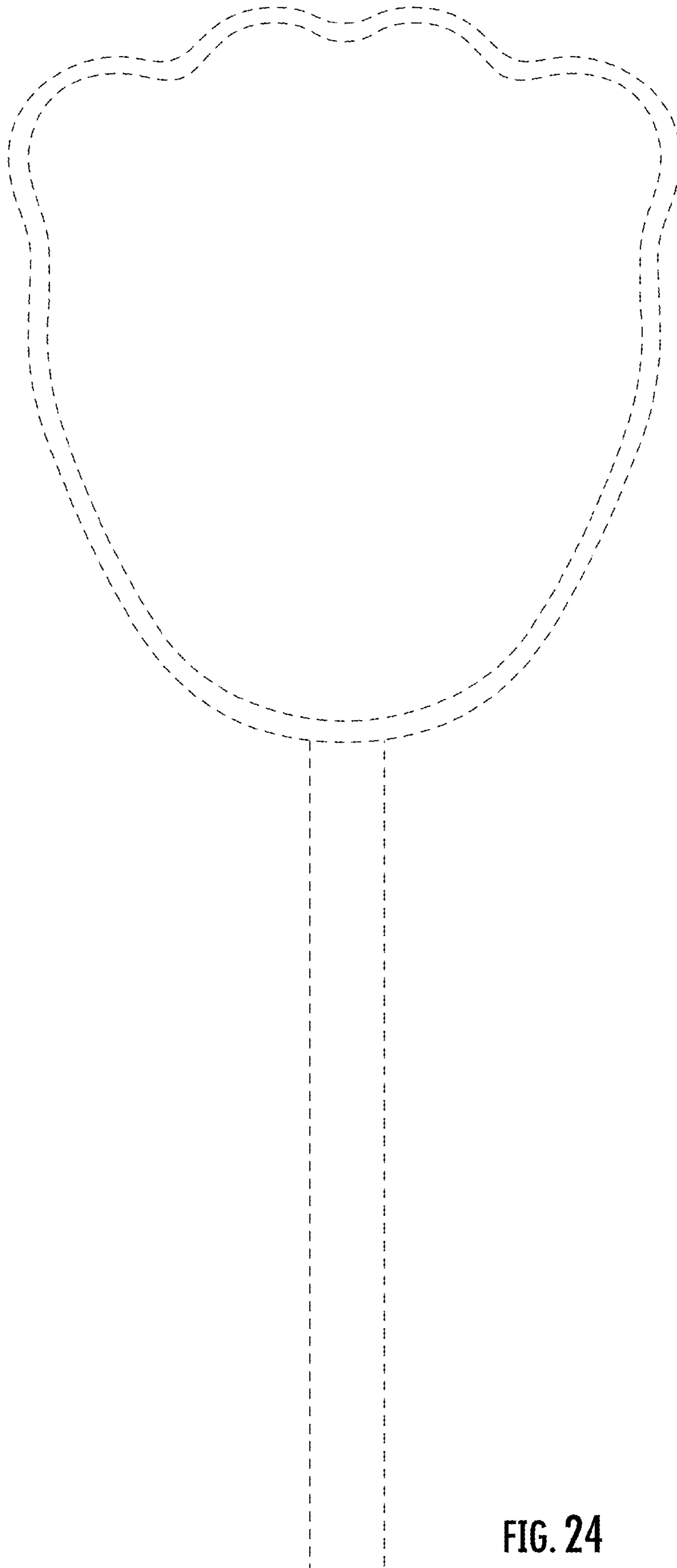

FIG. 24

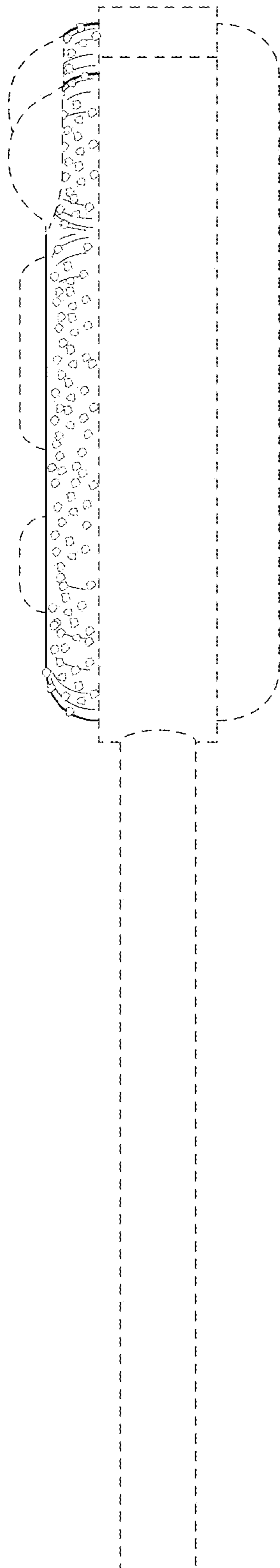

FIG. 25



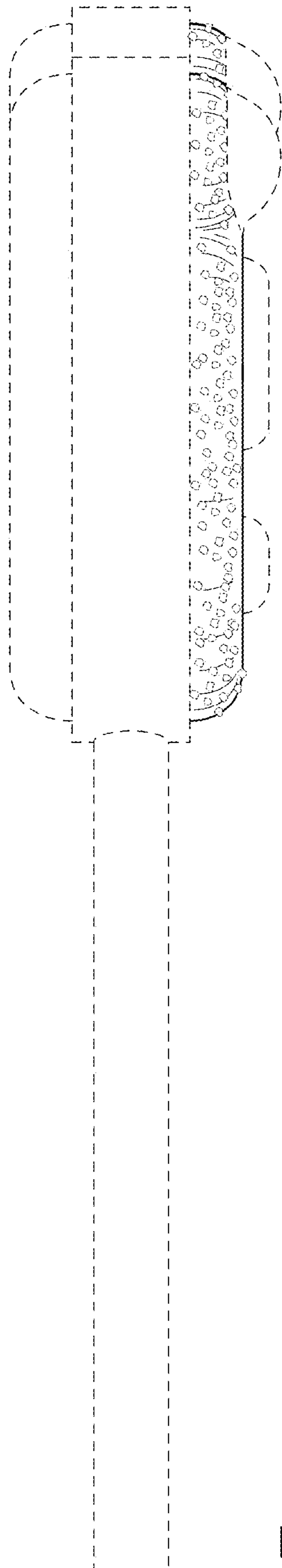

FIG. 26

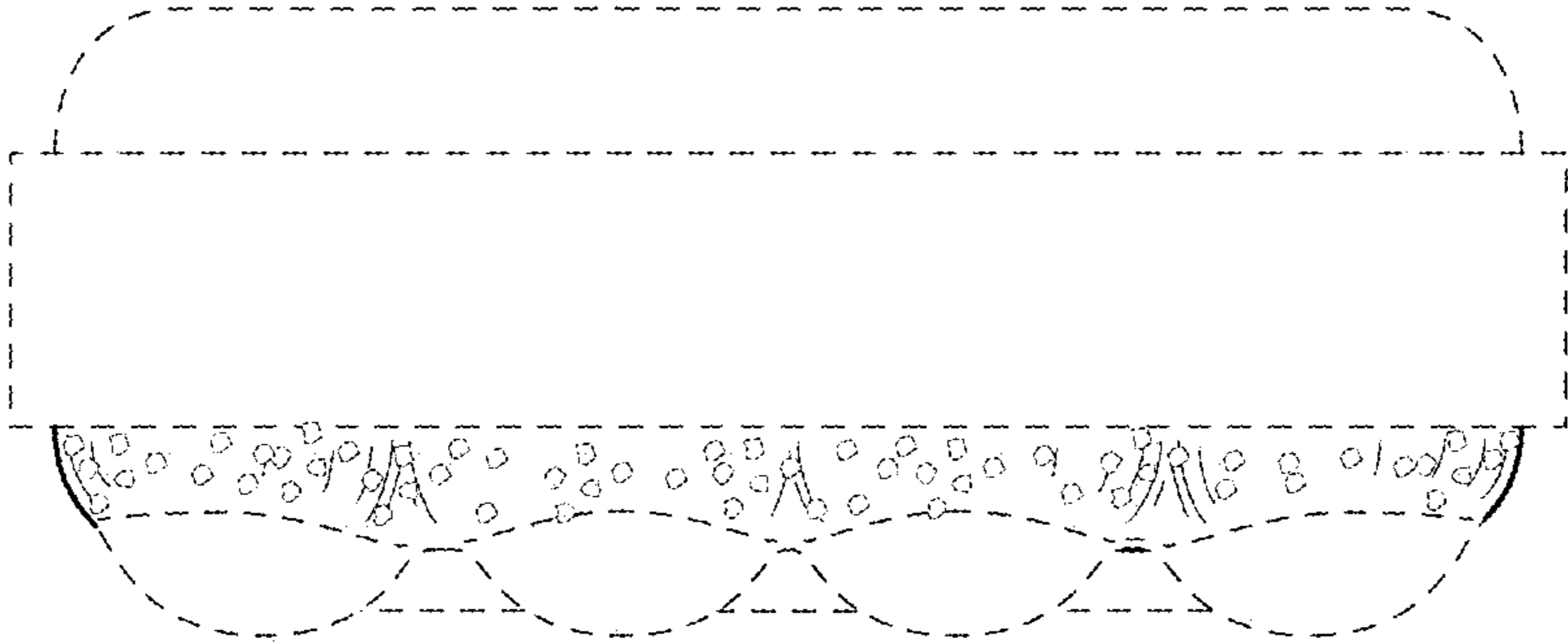

FIG. 27

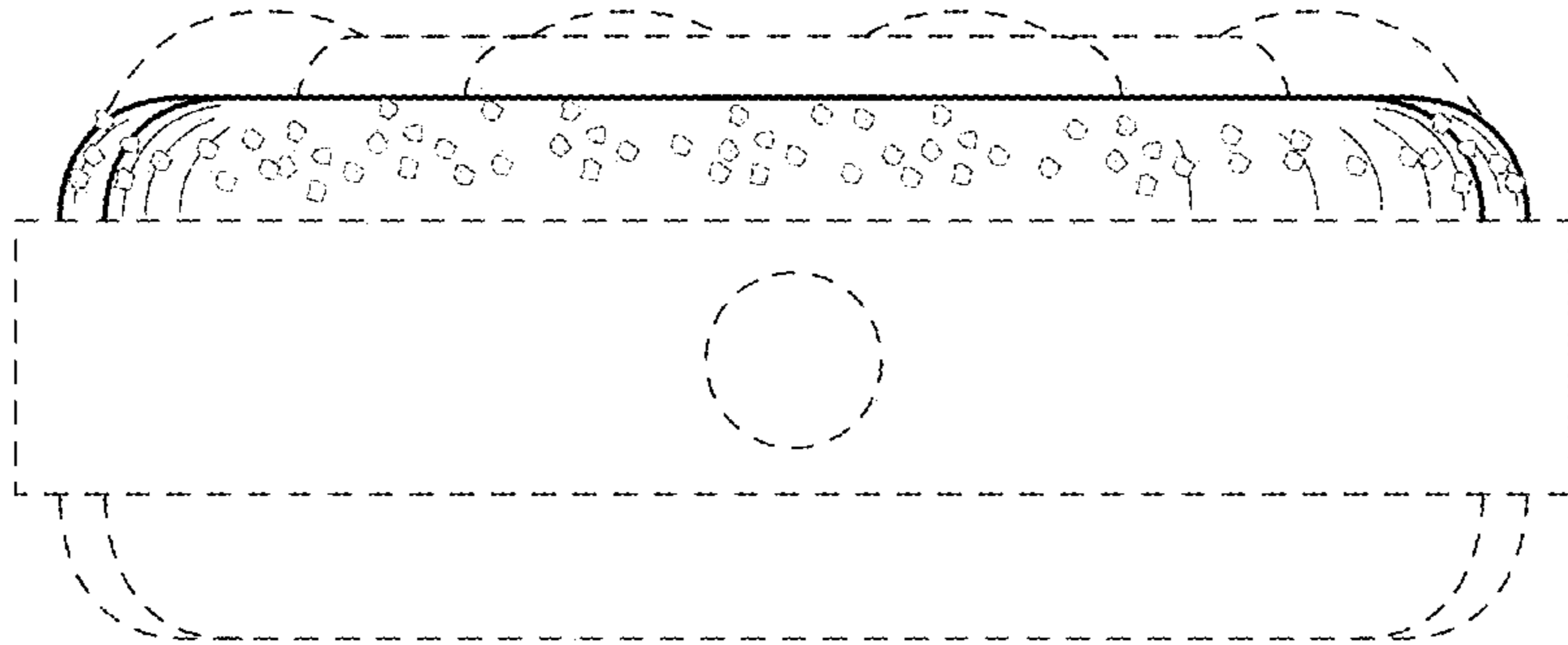

FIG. 28