



US00D948779S

(12) **United States Design Patent** (10) **Patent No.:** **US D948,779 S**  
**Liu** (45) **Date of Patent:** **\*\* Apr. 12, 2022**

(54) **ELECTRONIC CIGARETTE ATOMIZER**

(71) Applicant: **Tuanfang Liu**, Shenzhen (CN)

(72) Inventor: **Tuanfang Liu**, Shenzhen (CN)

(\*\*) Term: **15 Years**

(21) Appl. No.: **29/724,314**

(22) Filed: **Feb. 13, 2020**

(30) **Foreign Application Priority Data**

Nov. 28, 2019 (CN) ..... 201930659741.4

(51) **LOC (13) Cl.** ..... **27-02**

(52) **U.S. Cl.**  
USPC ..... **D27/162**

(58) **Field of Classification Search**

USPC ..... D27/100, 101, 162, 163, 164, 165, 166,  
D27/167, 168, 169, 170, 171, 172, 173,  
D27/174, 175, 176, 177, 178, 179, 180,  
D27/181, 182, 183, 184, 185, 186, 187,  
D27/188, 189, 190, 191, 192, 193;  
D28/91.1; D23/360, 362; D24/110,  
D24/110.4, 110.5, 110.6, 113  
CPC ..... A24F 40/10; A24F 40/40; A24F 40/46;  
A24F 40/42; A24F 40/44; A24F 40/485;  
A24F 40/50; A24F 40/60; A24F 40/90;  
A24F 40/53; A24F 40/70; A24F 40/48;  
A24F 40/51; A24F 40/57; A24F 40/05;  
A24F 40/65; A24F 40/20; A24F 47/002;  
A24F 40/30; A24F 7/00; A24F 47/00;  
A24F 1/32; A24F 40/00; A24F 40/49;  
A24F 40/85; A24F 40/95; A24F 7/04;  
A24F 9/16; A24F 47/008; A24F 15/015;  
A24F 40/465; A24F 42/60; A24F 1/02;  
A24F 2700/03; A24F 47/006; A24F  
13/00; A24F 13/14; A24F 15/01; A24F  
15/12; A24F 15/14;

(Continued)

(56) **References Cited**

U.S. PATENT DOCUMENTS

D729,440 S \* 5/2015 Liu ..... D27/101  
D740,488 S \* 10/2015 Leidel ..... D27/167

(Continued)

FOREIGN PATENT DOCUMENTS

CN 201730675352 \* 12/2017  
CN 201730619524 \* 5/2018

(Continued)

OTHER PUBLICATIONS

Falcon II Mesh Tank. By Matt From SMM. Dated Dec. 4, 2019.  
Found online [Mar. 1, 2021]. [https://www.youtube.com/watch?v=7HmgP\\_RloF8](https://www.youtube.com/watch?v=7HmgP_RloF8) (Year: 2019).\*

(Continued)

*Primary Examiner* — Marissa J Cash  
*Assistant Examiner* — William B Melliar  
(74) *Attorney, Agent, or Firm* — Matthias Scholl P.C.;  
Matthias Scholl

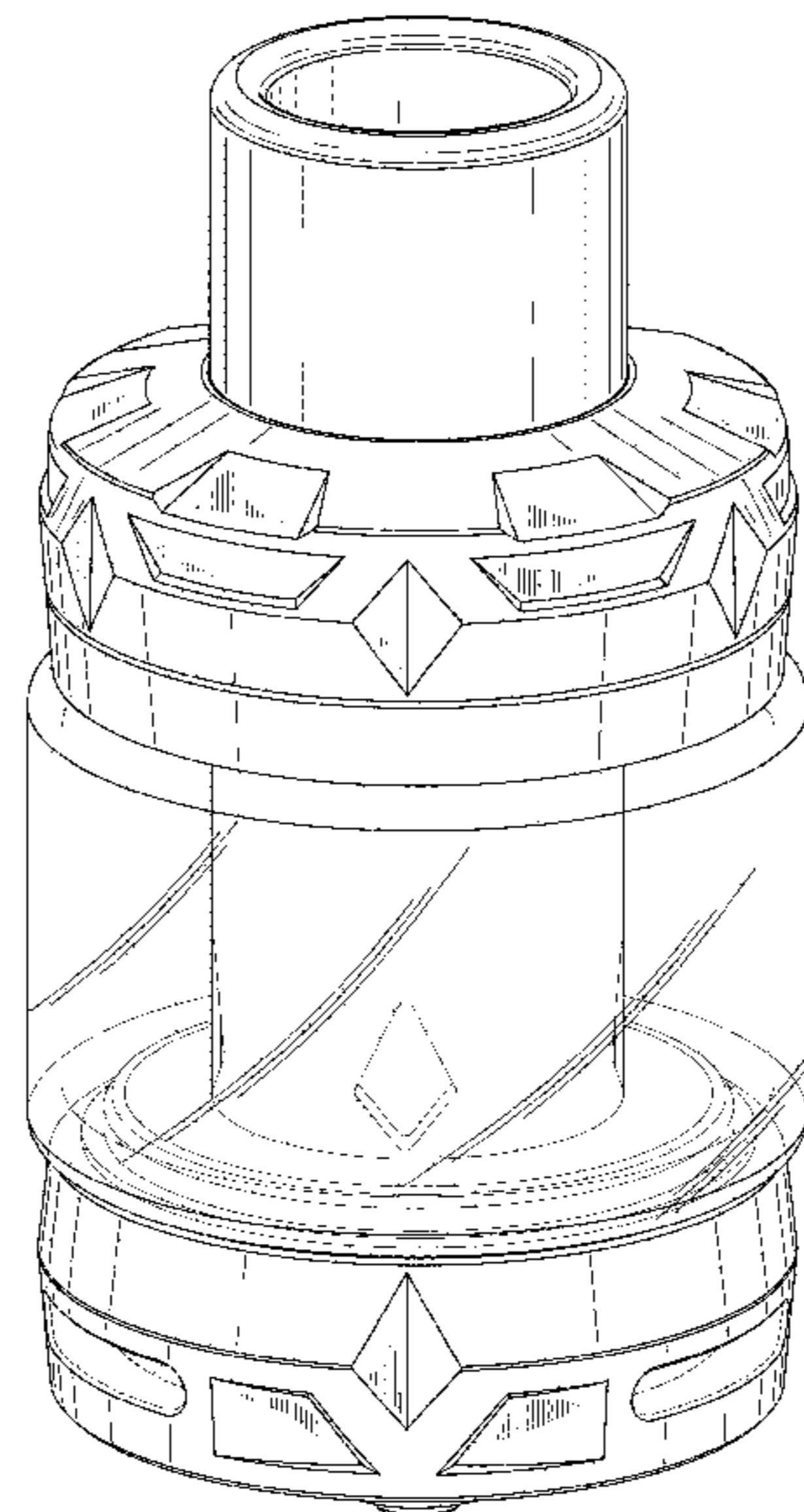
(57) **CLAIM**

The ornamental design for an electronic cigarette atomizer,  
as shown and described.

**DESCRIPTION**

FIG. 1 is a front elevation view of an electronic cigarette atomizer;  
FIG. 2 is a rear elevation view thereof;  
FIG. 3 is a left-side elevation view thereof;  
FIG. 4 is a right-side elevation view thereof;  
FIG. 5 is a top plan view thereof;  
FIG. 6 is a bottom plan view thereof;  
FIG. 7 is a perspective view thereof; and,  
FIG. 8 is a bottom perspective view thereof.  
The broken lines in the drawings depict portions of the  
electronic cigarette atomizer that form no part of the claimed  
design.

**1 Claim, 8 Drawing Sheets**



(58) **Field of Classification Search**

CPC ..... A24F 15/18; A24F 42/00; A24F 42/10;  
 A24F 7/02; A24F 47/004; A24F 1/00;  
 A24F 42/20; A61M 11/042; A61M 15/06;  
 A61M 2205/82; A61M 15/002; A61M  
 11/041; A61M 15/0001; A61M 15/0085;  
 A61M 11/001; A61M 11/04; A61M  
 11/044; A61M 15/0015; A61M 15/0021;  
 A61M 15/0028; A61M 15/0091; A61M  
 15/0095; A61M 16/0808; A61M  
 2205/0211; A61M 2205/0238; A61M  
 2205/0272; A61M 2205/123; A61M  
 2205/3334; A61M 2205/58; A61M  
 2205/7536; A61M 2205/3653; A61M  
 2205/18; A61M 2205/3317; A61M  
 2205/50; A61M 2205/52; A61M  
 2205/3368; A24B 15/167

See application file for complete search history.

(56) **References Cited**

U.S. PATENT DOCUMENTS

D771,219 S \* 11/2016 Gilbarte ..... D22/117  
 D771,307 S \* 11/2016 Wu ..... D27/101  
 D795,495 S \* 8/2017 Li ..... D27/100  
 D811,652 S \* 2/2018 Liu ..... D27/167

D836,243 S \* 12/2018 Liu ..... D27/167  
 D861,978 S \* 10/2019 Lai ..... D27/167  
 D869,752 S \* 12/2019 Dong ..... D27/162  
 D881,456 S \* 4/2020 Chen ..... D27/162  
 D883,567 S \* 5/2020 Liu ..... D27/162  
 D900,387 S \* 10/2020 Liu ..... D27/162  
 D917,778 S \* 4/2021 Liu ..... D27/162  
 D923,867 S \* 6/2021 Liu ..... D27/167  
 2017/0049153 A1\* 2/2017 Guo ..... A61M 15/06  
 2019/0134320 A1\* 5/2019 Fornarelli ..... H05B 3/44  
 2019/0357594 A1\* 11/2019 Liu ..... A24F 40/60  
 2020/0113236 A1\* 4/2020 Qiu ..... A24F 40/49

FOREIGN PATENT DOCUMENTS

CN 201730590035 \* 6/2018  
 CN 201830216651 \* 7/2018  
 CN 201830001078 \* 8/2018  
 CN 202030328033.5 \* 12/2020

OTHER PUBLICATIONS

Zeus X RTA. By Matt From SMM. Dated Feb. 27, 2019. Found online [Mar. 1, 2021]. <https://www.youtube.com/watch?v=lcAFPIyEdDQ> (Year: 2019).\*

21700 Uwell Nunchaku 2 Kit. By Mike Vapes. Dated Feb. 27, 2019. Found online [Mar. 1, 2021]. <https://www.youtube.com/watch?v=xChn7fmhW9M> (Year: 2019).\*

\* cited by examiner

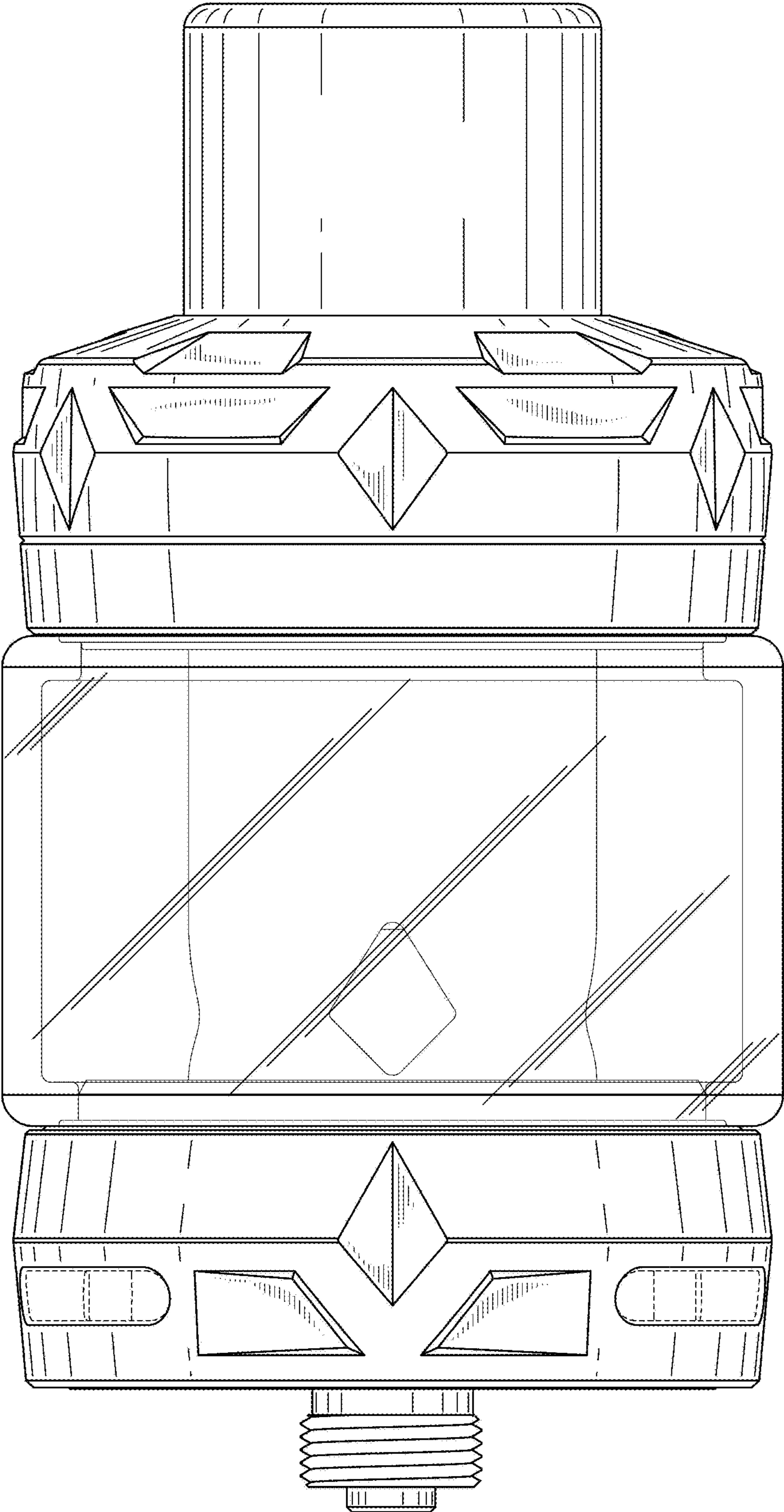


FIG. 1

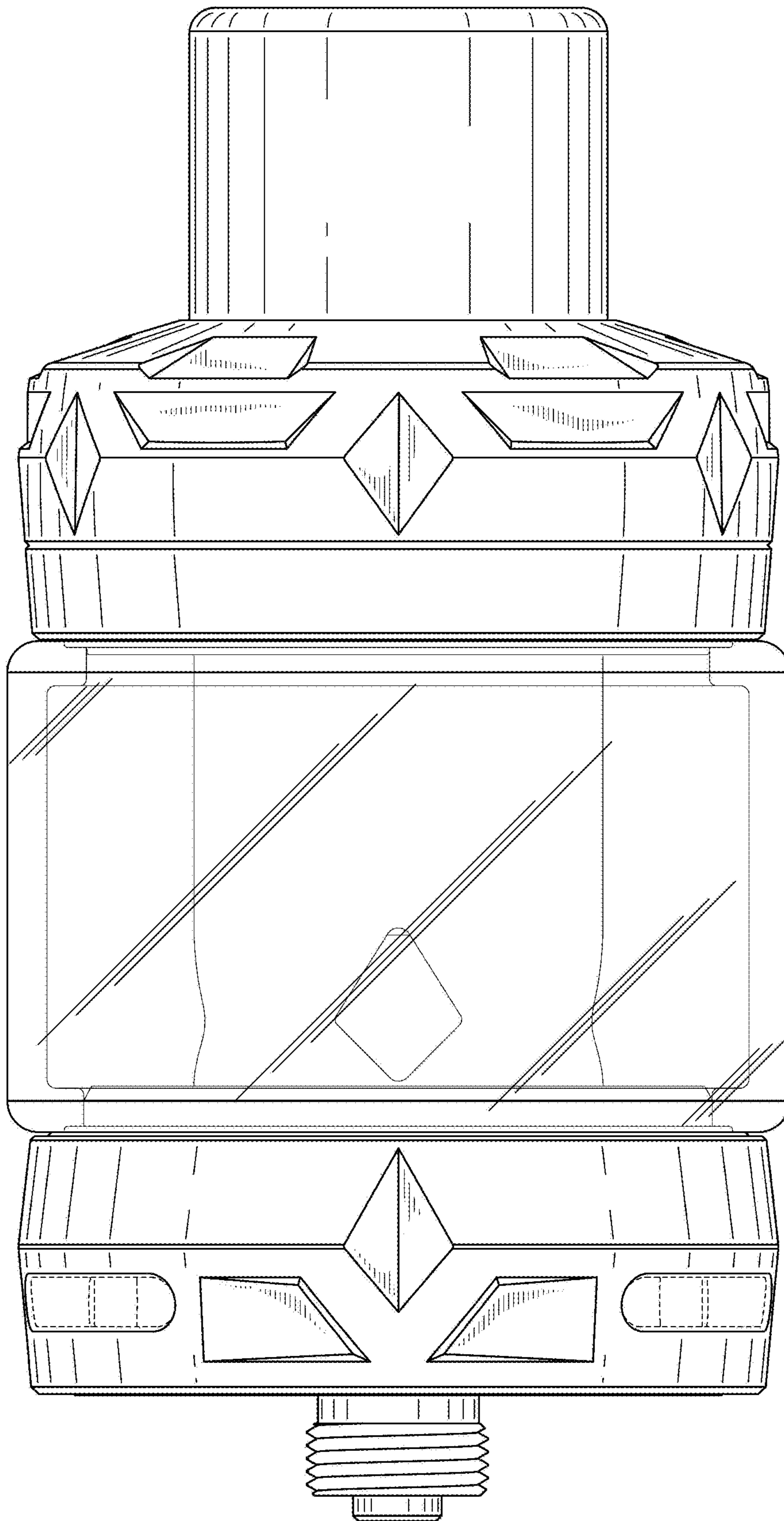
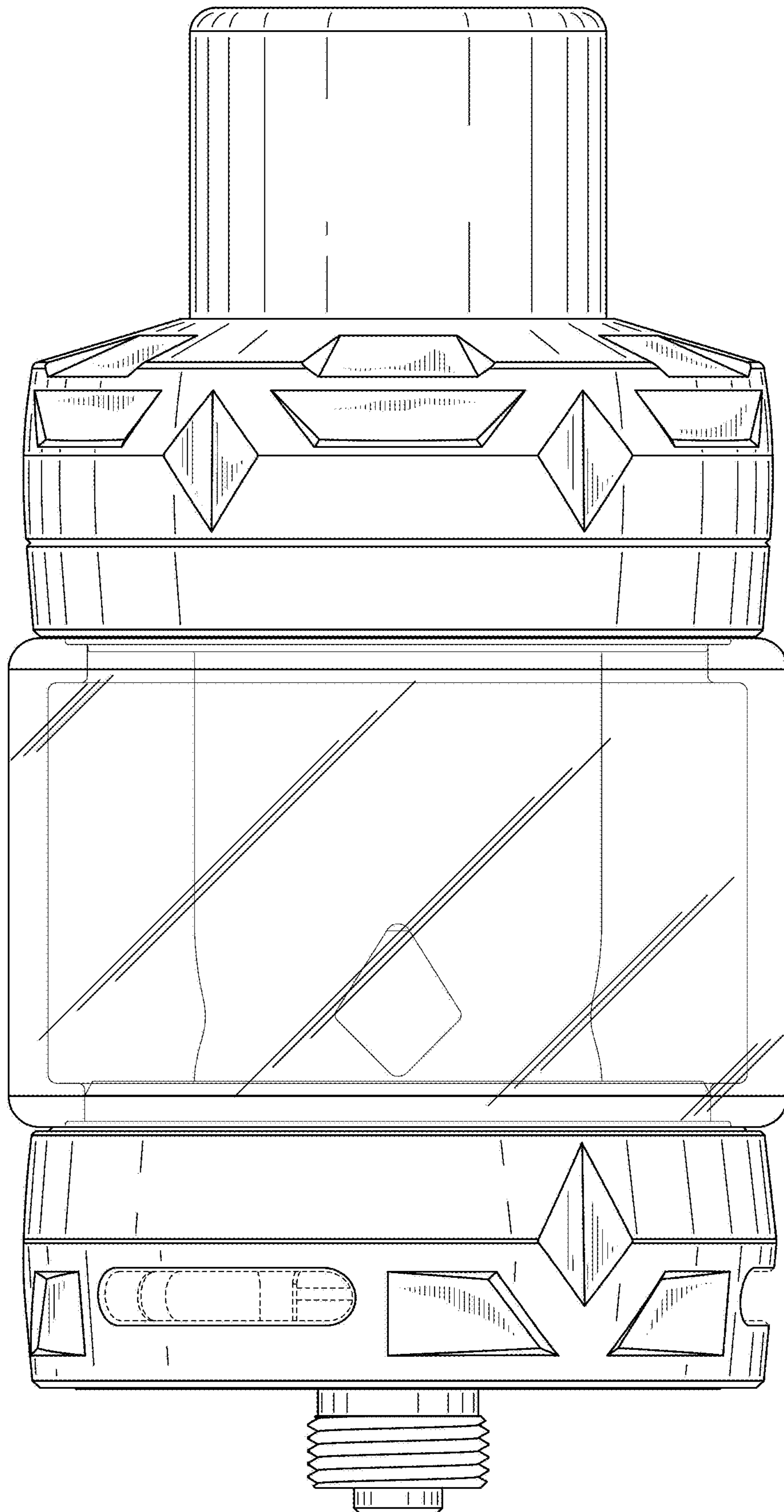
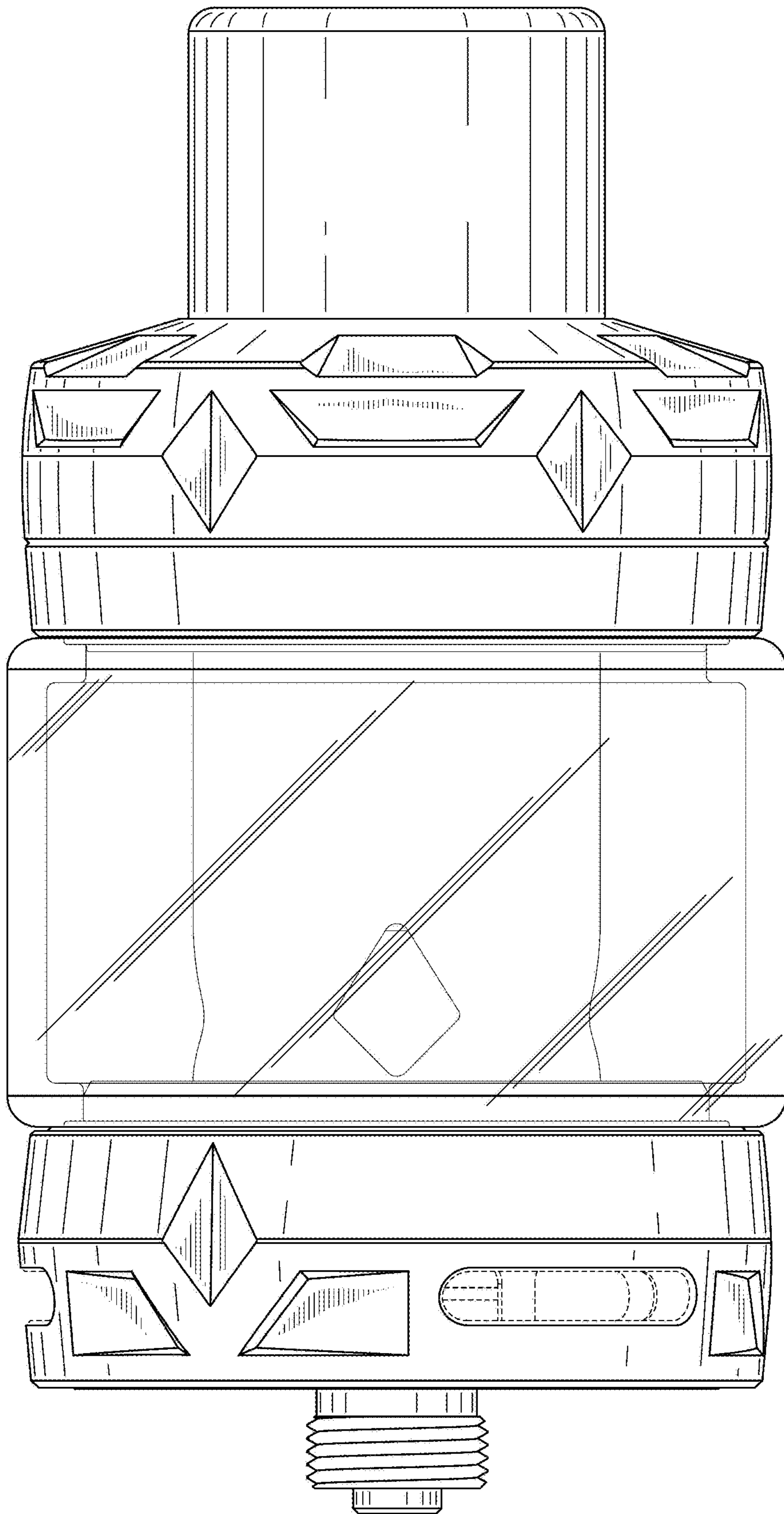


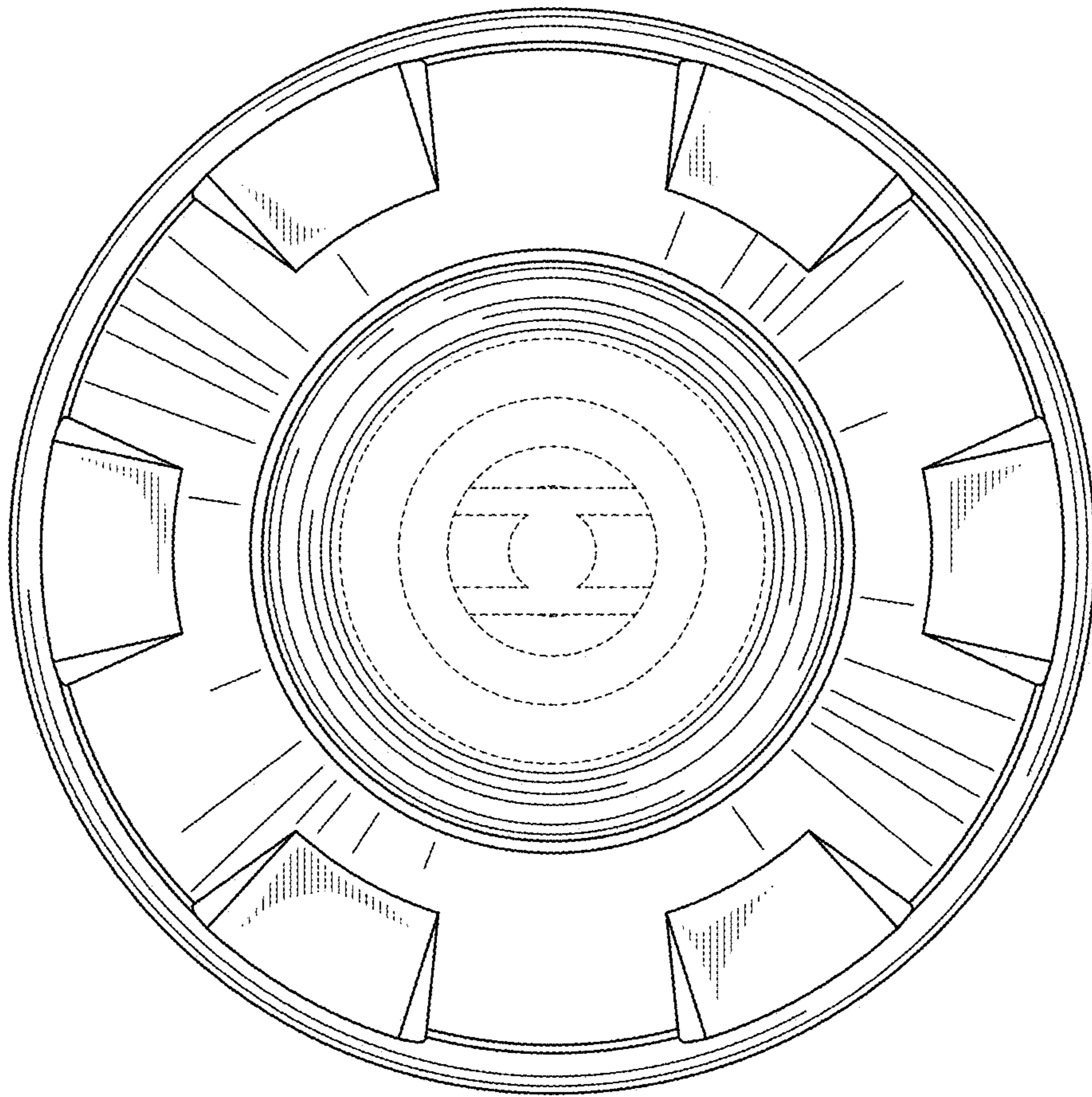
FIG. 2



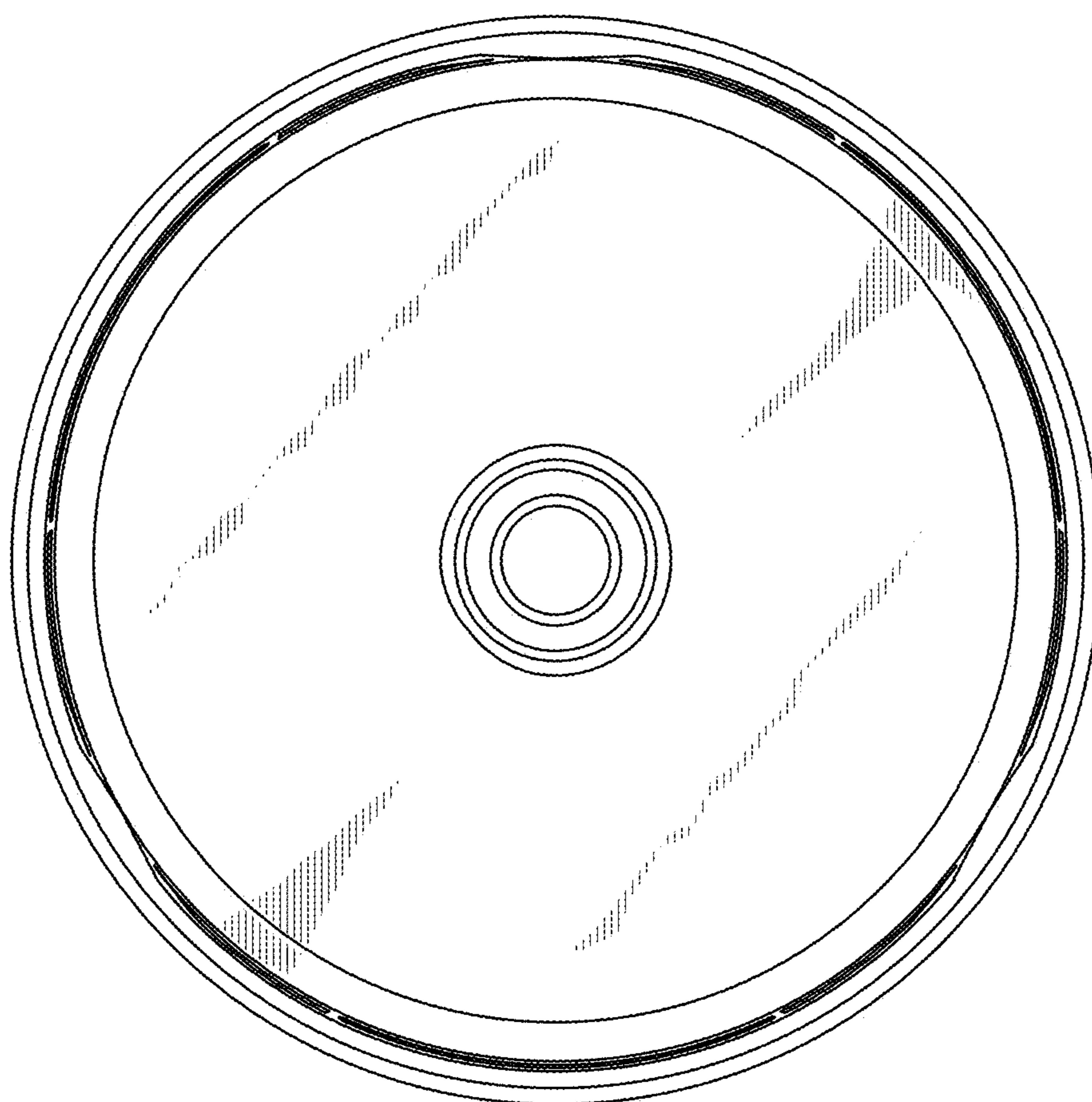
**FIG. 3**



**FIG. 4**

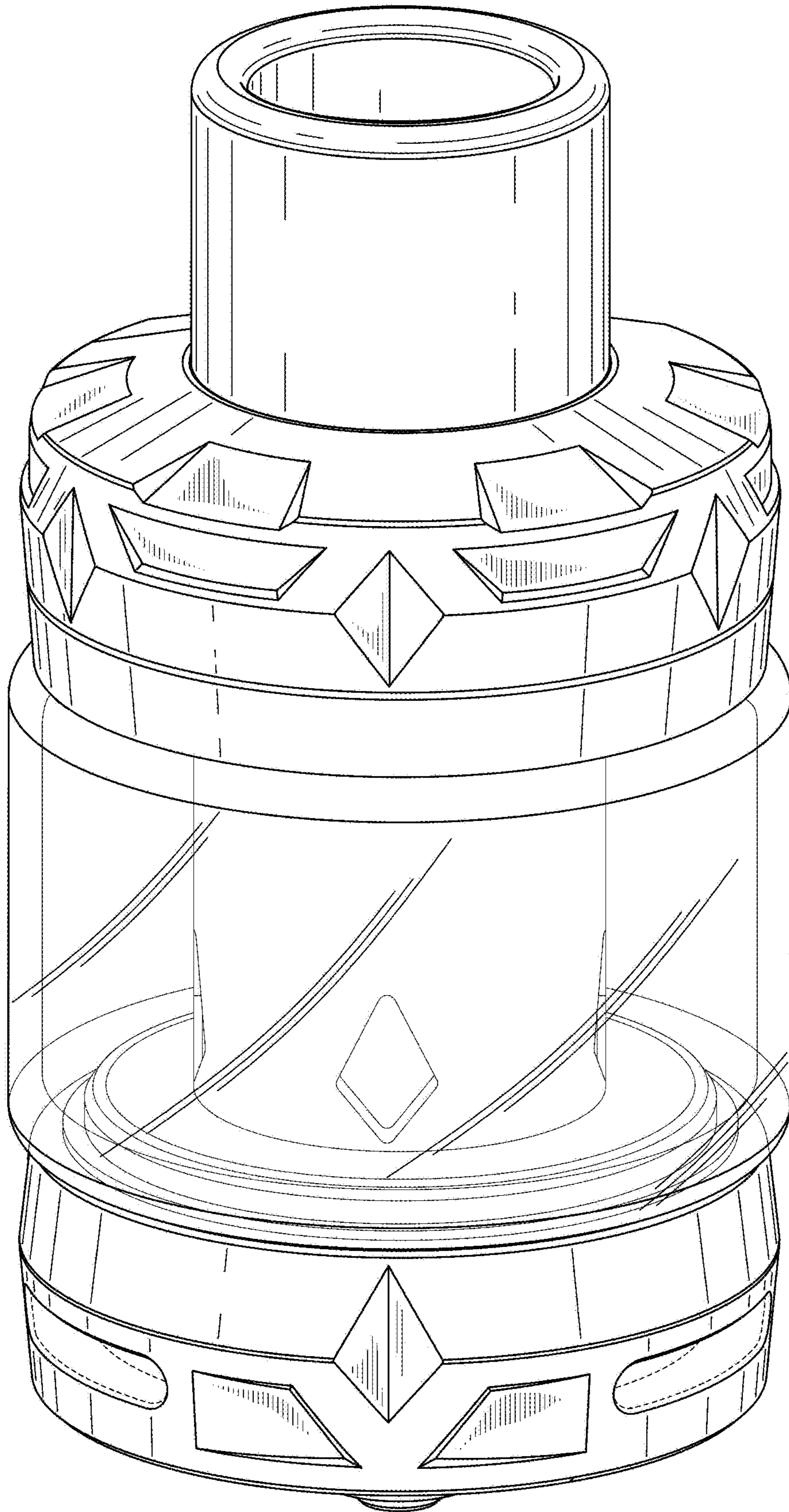


**FIG. 5**



**FIG. 6**





**FIG. 7**

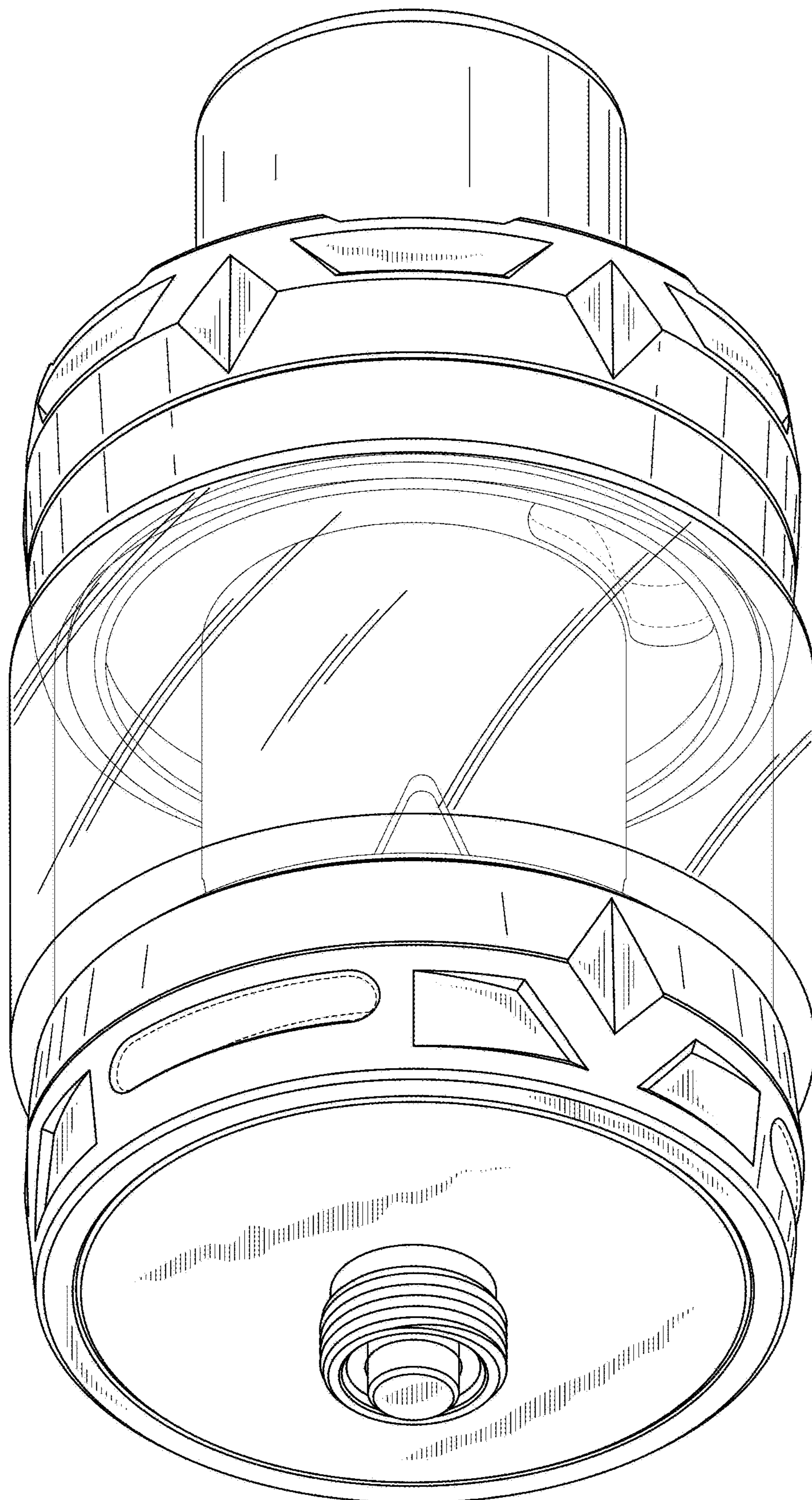


FIG. 8