



US00D948656S

(12) **United States Design Patent**
Zhang

(10) **Patent No.:** **US D948,656 S**
(45) **Date of Patent:** **** Apr. 12, 2022**

(54) **MOUSE CAGE**

(71) Applicant: **Zhenkun Zhang**, Shenzhen (CN)

(72) Inventor: **Zhenkun Zhang**, Shenzhen (CN)

(**) Term: **15 Years**

(21) Appl. No.: **29/777,001**

(22) Filed: **Apr. 1, 2021**

(51) **LOC (13) Cl.** **22-02**

(52) **U.S. Cl.**
USPC **D22/119**

(58) **Field of Classification Search**
USPC D22/119

CPC A01M 23/00; A01M 23/04; A01M 23/005;
A01M 23/08; A01M 23/16; A01M 23/18;
A01M 23/22; A01M 2200/00; A01K
29/00; A01K 1/031; A01K 1/035

See application file for complete search history.

(56) **References Cited**

U.S. PATENT DOCUMENTS

D291,588 S *	8/1987	Melton	D22/119
D854,115 S *	7/2019	Yang	D22/119
D855,742 S *	8/2019	Yang	D22/119
D861,824 S *	10/2019	Yang	D22/119
D890,289 S *	7/2020	Luo	D22/119
D899,553 S *	10/2020	Yang	D22/119
2013/0206072 A1	8/2013	Cogswell et al.		
2014/0020278 A1*	1/2014	Smith	A01M 27/00 43/79
2017/0112120 A1*	4/2017	Smith	A01M 23/36
2018/0139949 A1*	5/2018	Liu	A01M 23/38
2020/0267965 A1*	8/2020	Broskey	A01M 23/16
2021/0015088 A1*	1/2021	McGrade	A01M 23/30

FOREIGN PATENT DOCUMENTS

WO	WO2013/029689	*	3/2013	A01M 23/30
WO	WO2013/156395	*	10/2013	A01M 23/30

OTHER PUBLICATIONS

6 pack humane mouse traps . . . https://www.amazon.com/Humane-Mouse-Traps-Release-Poison/dp/B07SD68LVS/ref=sr_1_33?keywords=mouse+hotel&qid=1637118008&qsid=143-4559563-

3999450&sr=8-33&sres=B083SSNL7X%2CB00004RAMU%2CB073GRKG88%2CB08HJB4QFJ%2CB000YFA7HW%2CB00BGADZ6E%2CB08219DSXP%2CB06XX7YGKQ%2CB08KGTB3P7%2CB007E83LUM%2CB07PDPVZBP%2CB07YL5BLK4%2CB00N6XKV4I%2CB00N6XKVNY%2CB012VK649C%2CB081LFHSM1%2CB07L8JNPF2%2CB01N6O3IB3%2CB0725X2WHJ%2CB08ML3TRMK&srpt=PEST_CONTROL_DEVICE (Year: 2020).*

[\[* cited by examiner\]\(https://www.amazon.com/Handle-Transparent-Reusable-Capture-Animals/dp/B08Z2VLCR6/ref=sr_1_1?keywords=2Pcs+large+mouse+traps+handle+mice+trap%2C+transparent+reusable&qid=1637120222&qsid=143-4559563-3999450&sr=8-1&sres=B08Z2VLCR6%2CB007E83LUM%2CB08HJB4QFJ%2CB012VK649C%2CB097JTGVL1%2CB00N6XKVNY%2CB078YD8YRD%2CB08CRFRGZ4%2CB08LV4LSW5%2CB012VJLZOM%2CB077SZBPRS%2CB07PDPVZBP%2CB01MZ19B3O%2CB06XX7YGKQ%2CB005IMZ9TC%2CB074Y2PW1X%2CB07SD68LVS%2CB073GRKG88%2CB07Q3M6QYK%2CB07331WZ6G&srpt=PEST_CONTROL_DEVICE \(Year: 2021\).*</p></div>
<div data-bbox=\)](https://www.amazon.com/Humane-Mouse-Trap-Indoors-Outdoors/dp/B08G5BJSZG/ref=sxin_13_pa_sp_search_thematic_sspa?cv_ct_cx=mouse+hotel&keywords=mouse+hotel&pd_rd_i=B08G5BJSZG&pd_rd_r=07d226ed-9697-4541-9f33-27d7b4f97af6&pd_rd_w=FodQO&pd_rd_wg=XrCrH&pf_rd_p=69e6ba92-4b2b-4486-a0ef-136583f2d22c&pf_rd_r=H1XGZ22SX7NN9Q0PXX0&qid=1637118623&sr=1-3-a73d1c8c-2fd2-4f19-aa41-2df022bcb241-spons&psc=1&spLa=ZW5jcnlwdGVkUXVhbGlmaWVyPUEzQ0NGTDJZVU9FTFEyJmVuY3J5cHRIZEikPUEwNzgiODAwWVGVIVNTU1CM1RSJmVuY3J5cHRIZEFkSWQ9QTA1MTc0NzJPNVhaMzJUQ0ZBVVkmD2lkZ2V0TmFtZT1zcF9zZWZyY2hfdGhlcW0aWmMmYWN0aW9uPWNsaWNrUmVkaXJlY3QmZG9Ob3NTU1CM1RSJmVuY3J5cHRIZEFkSWQ9QTA1MTc0NzJPNVhaMzJUQ0ZBVVkmD2lkZ2V0TmFtZT1zcF9zZWZyY2hfdGhlcW0aWmMmYWN0aW9uPWNsaWNrUmVkaXJlY3QmZG9Ob3RMb2dDbGljaZl0cnVI (Year: 2020).*</p></div>
<div data-bbox=)

Primary Examiner — Catherine R Oliver-Garcia

(57) **CLAIM**

The ornamental design for a mouse cage, as shown and described.

DESCRIPTION

FIG. 1 is a perspective view of a mouse cage showing my new design;

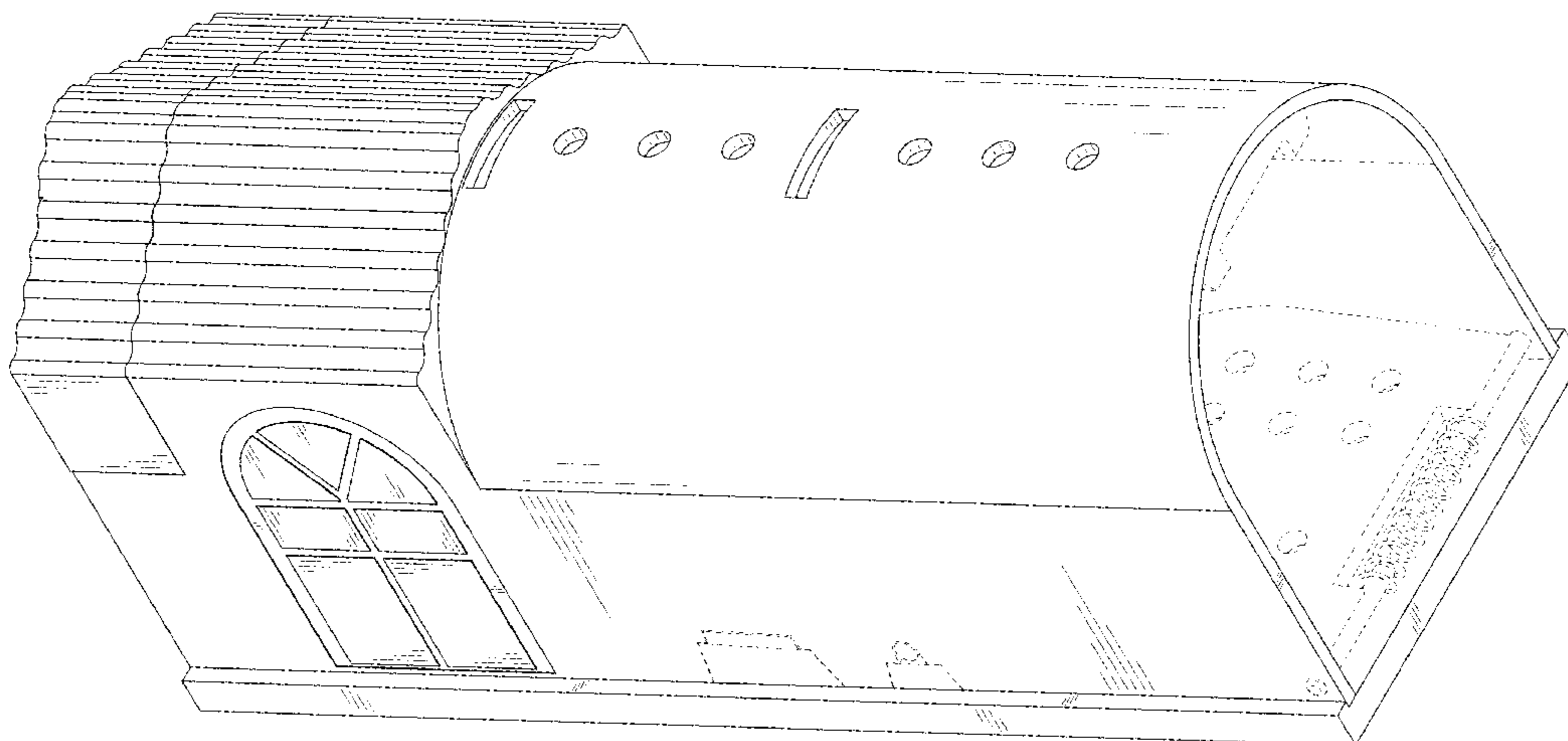

FIG. 2 is another perspective view thereof;
FIG. 3 is another perspective view thereof;
FIG. 4 is a front elevational view thereof;
FIG. 5 is a rear elevational view thereof;
FIG. 6 is a left side elevational view thereof;
FIG. 7 is a right side elevational view thereof;
FIG. 8 is a top plan view thereof;
FIG. 9 is a bottom plan view thereof;
FIG. 10 is a perspective view of the mouse cage where the mouse cage is in a configuration of use; and,
FIG. 11 is an exploded perspective view of the mouse cage. The broken lines in FIG. 10 depict environment that form no part of the claimed design. The broken lines in FIG. 11 depict portions of the mouse cage that form no part of the claimed design.

1 Claim, 11 Drawing Sheets

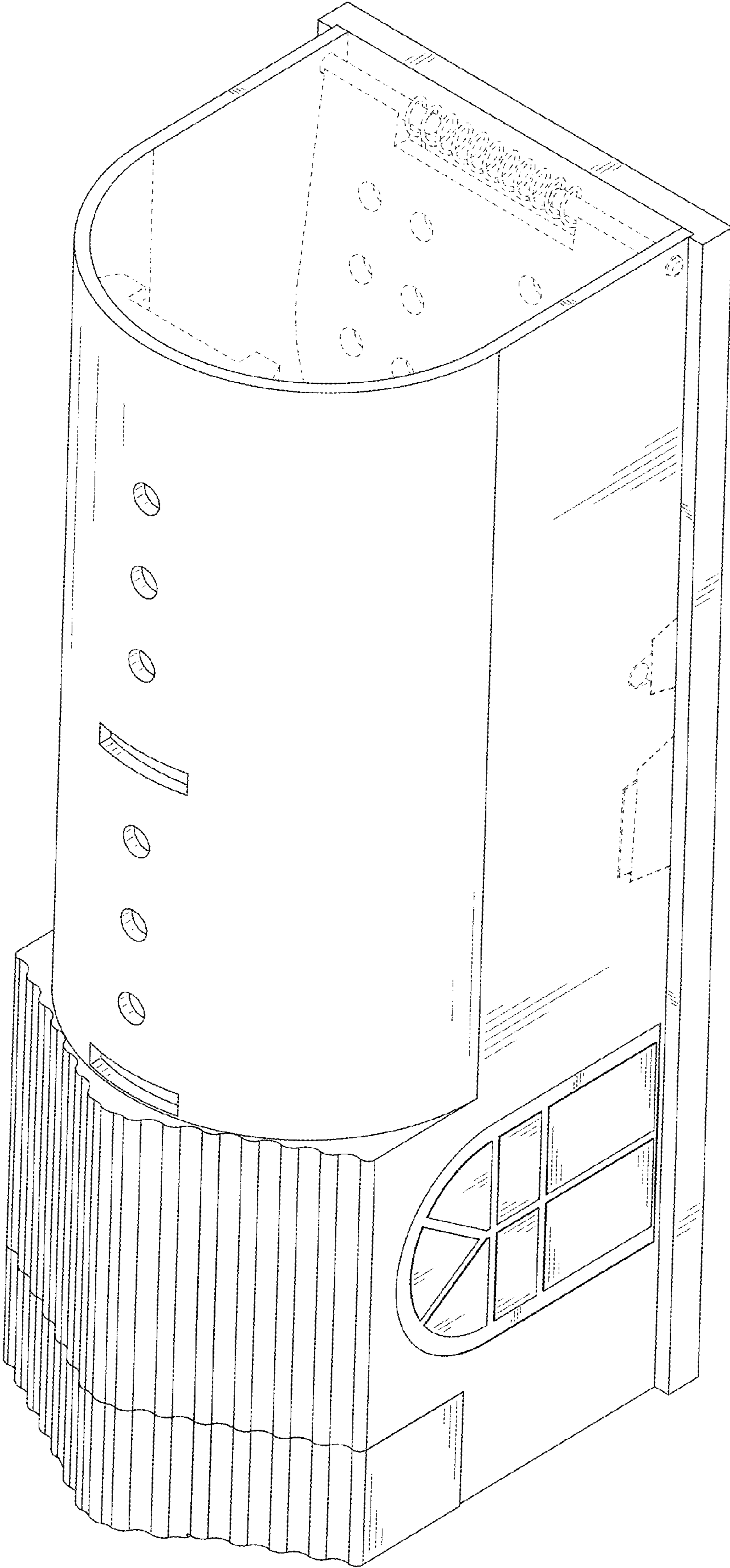

FIG. 1

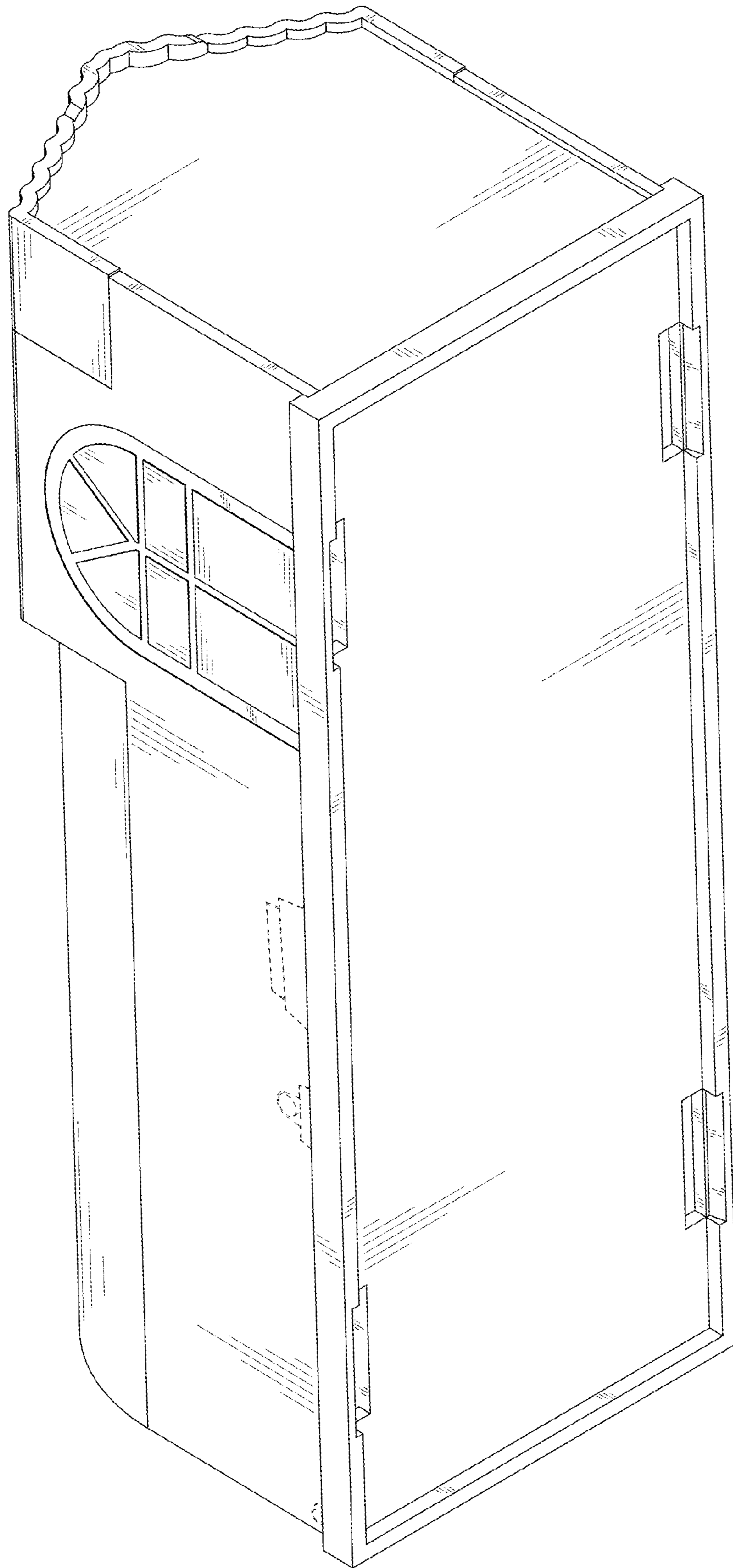

FIG. 2

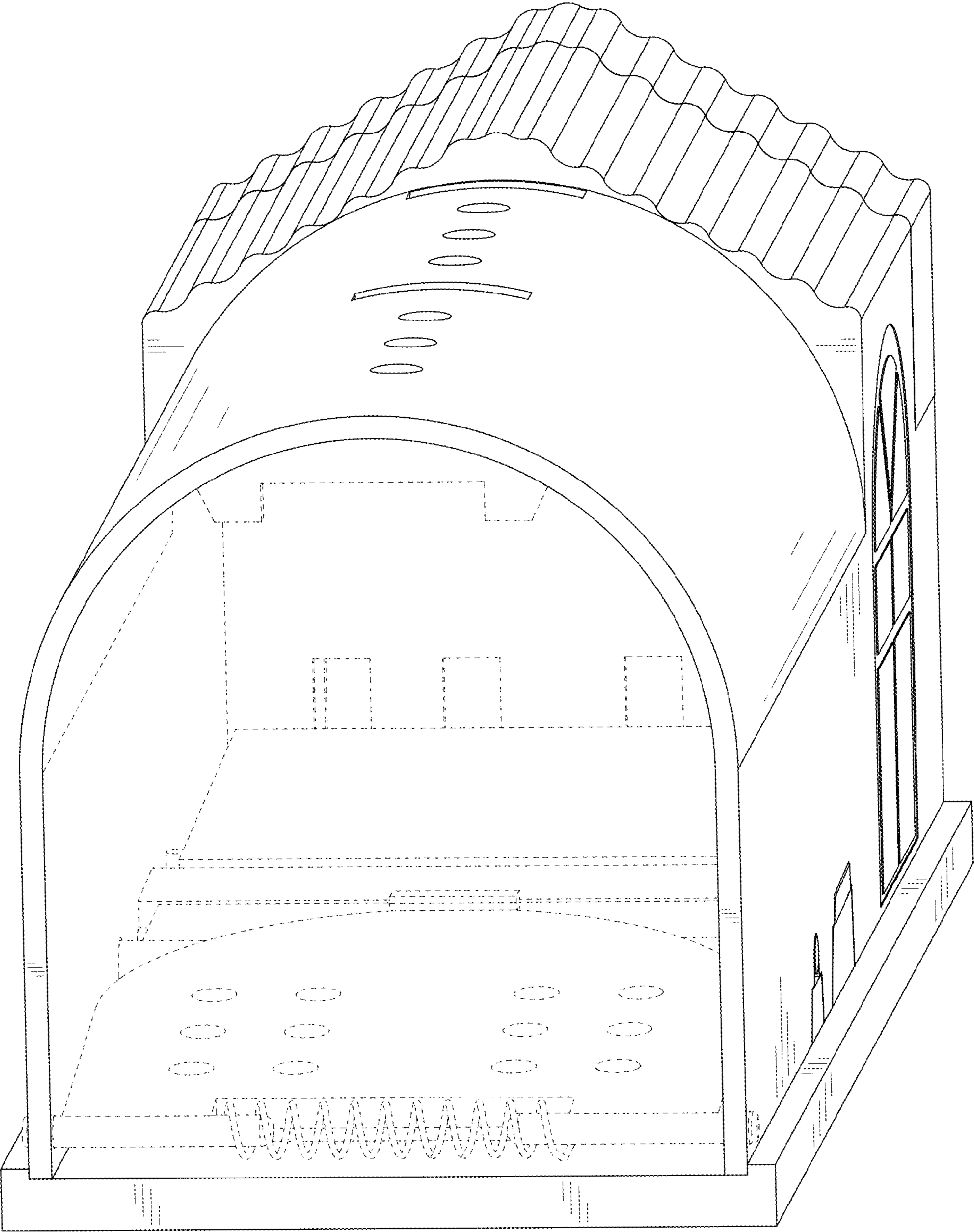

FIG. 3

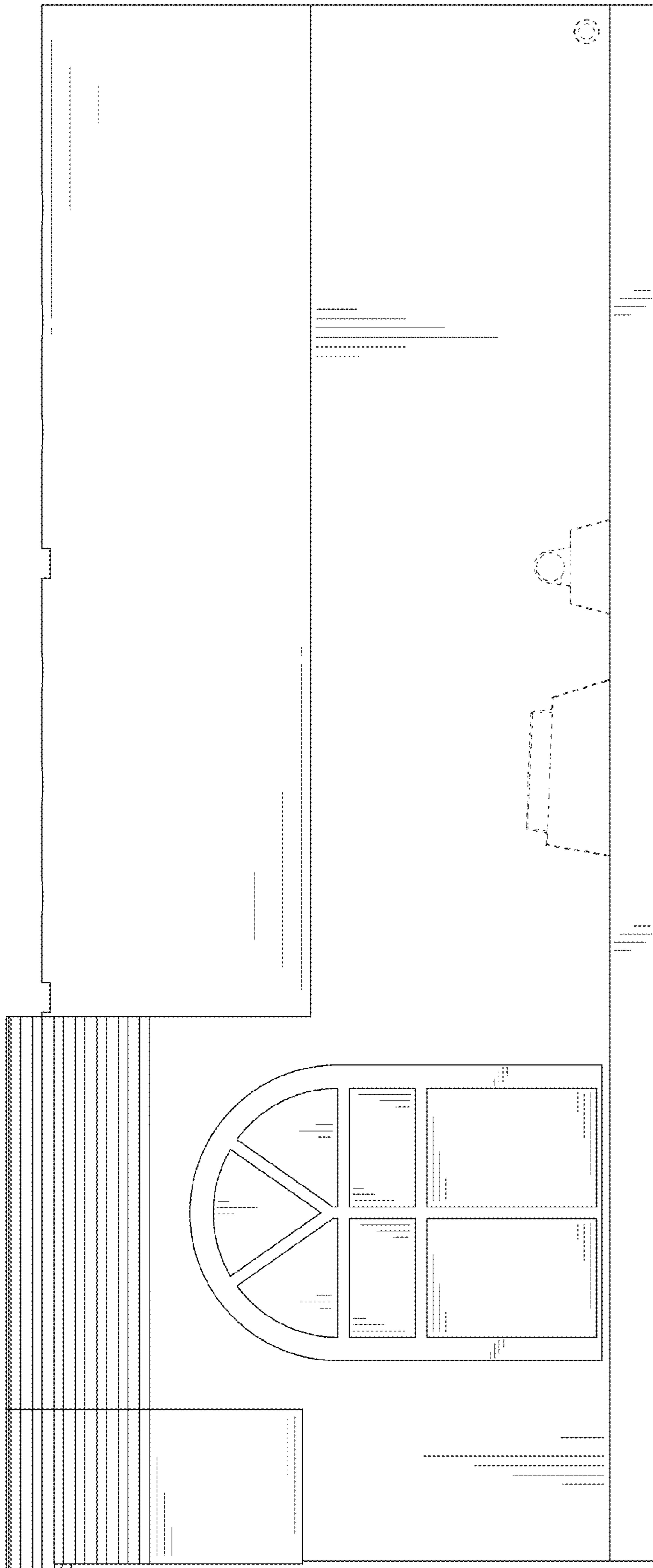

FIG. 4

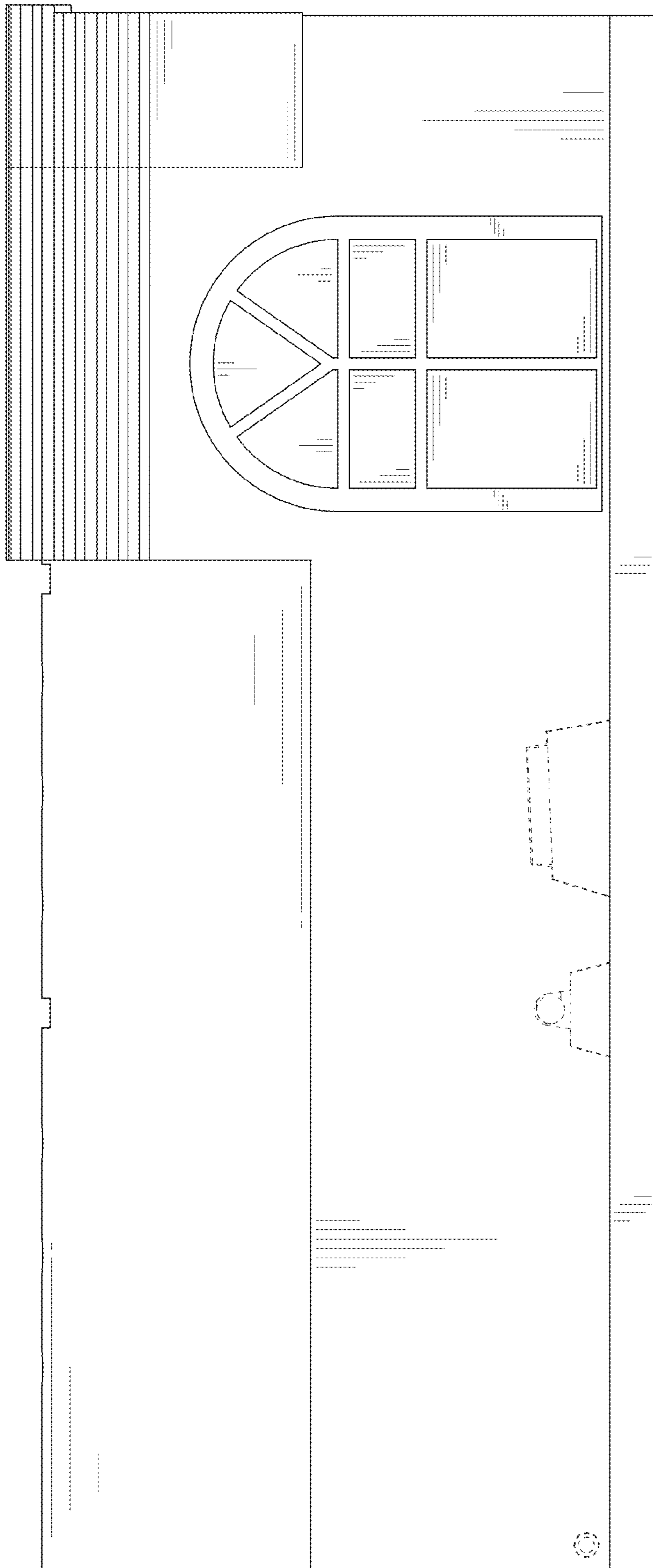

FIG. 5

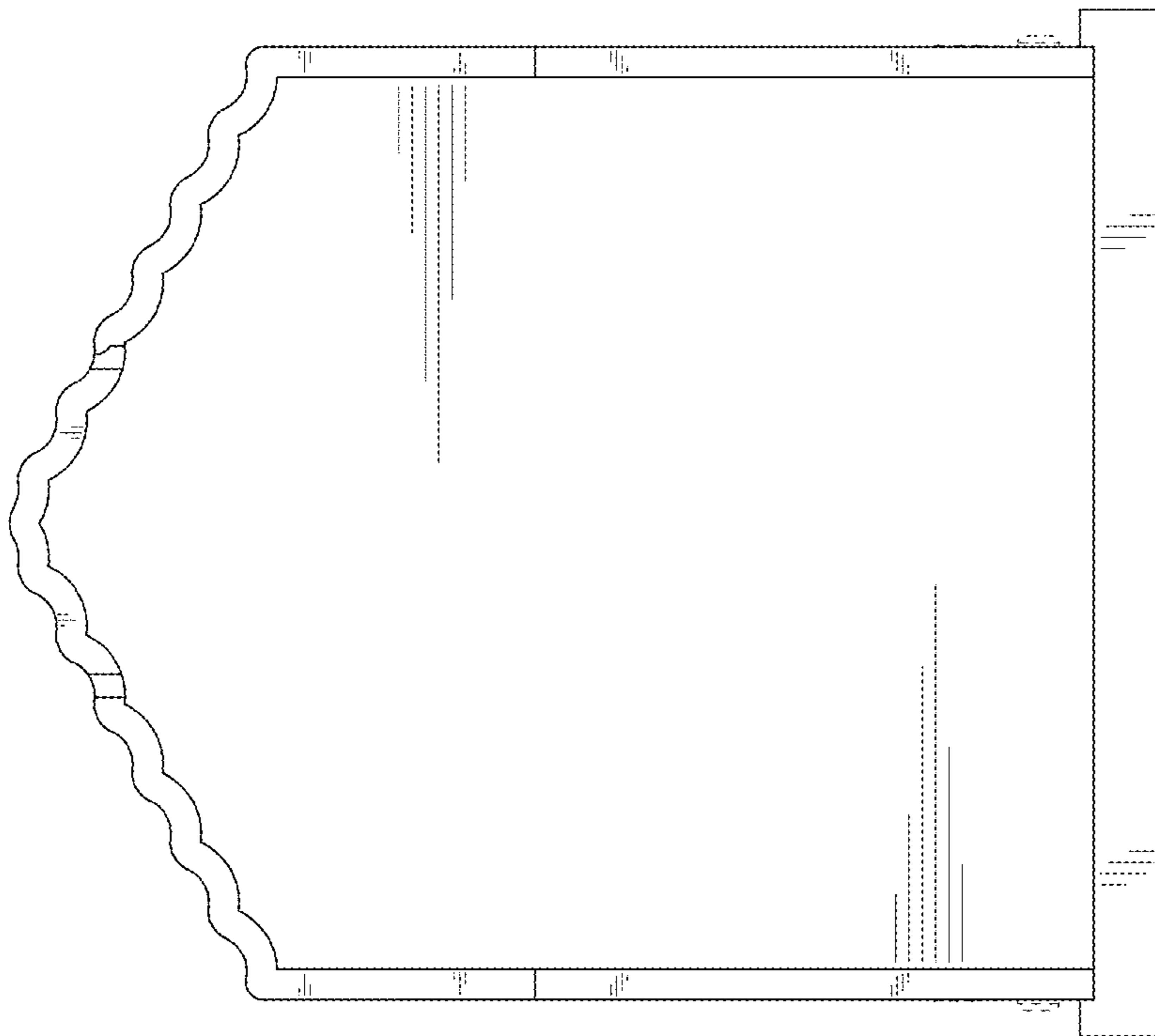

FIG. 6

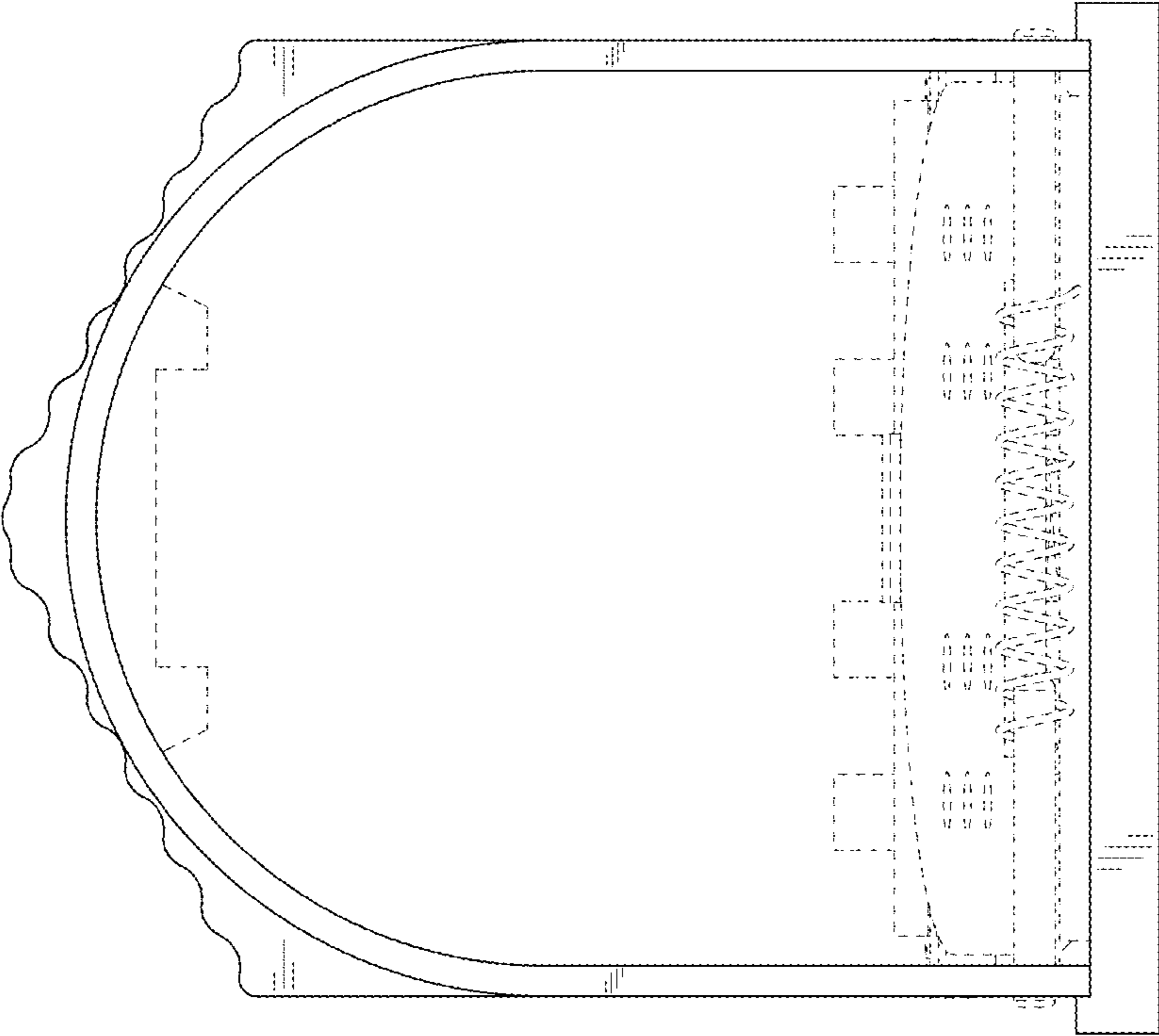

FIG. 7

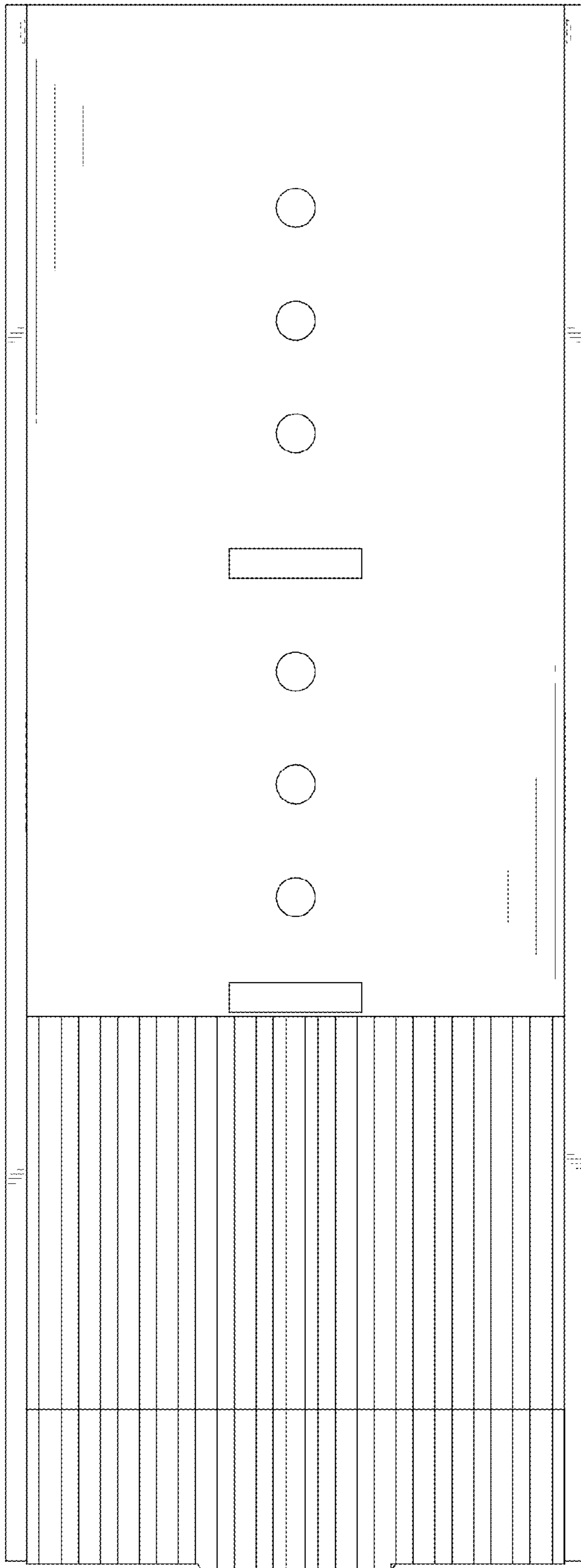

FIG. 8

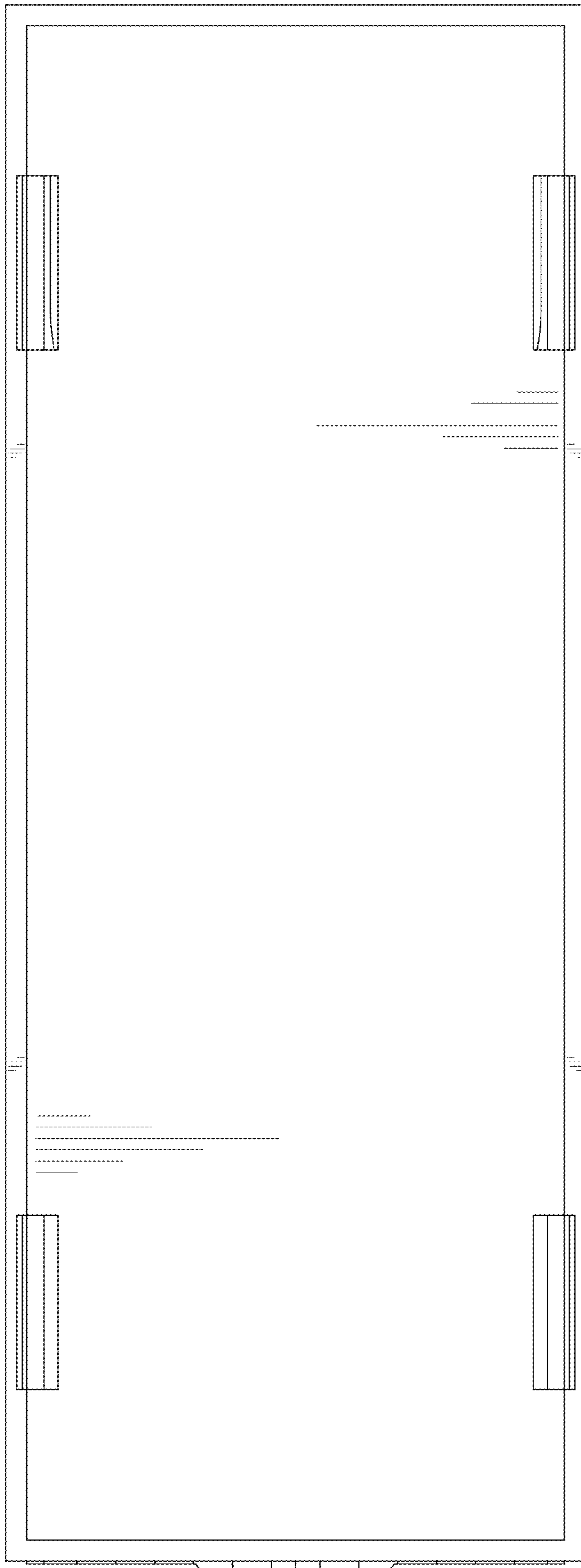

FIG. 9

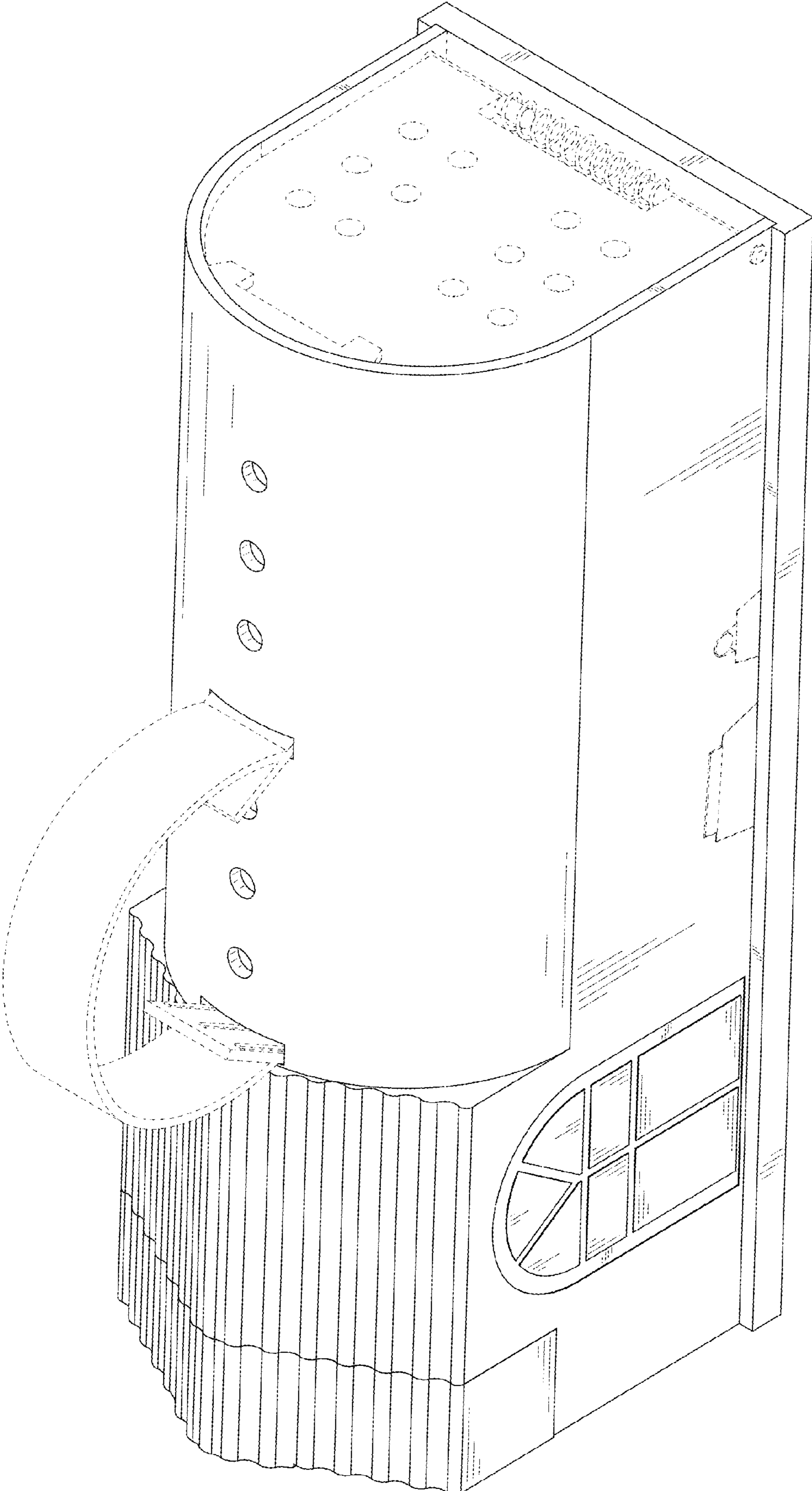

FIG. 10

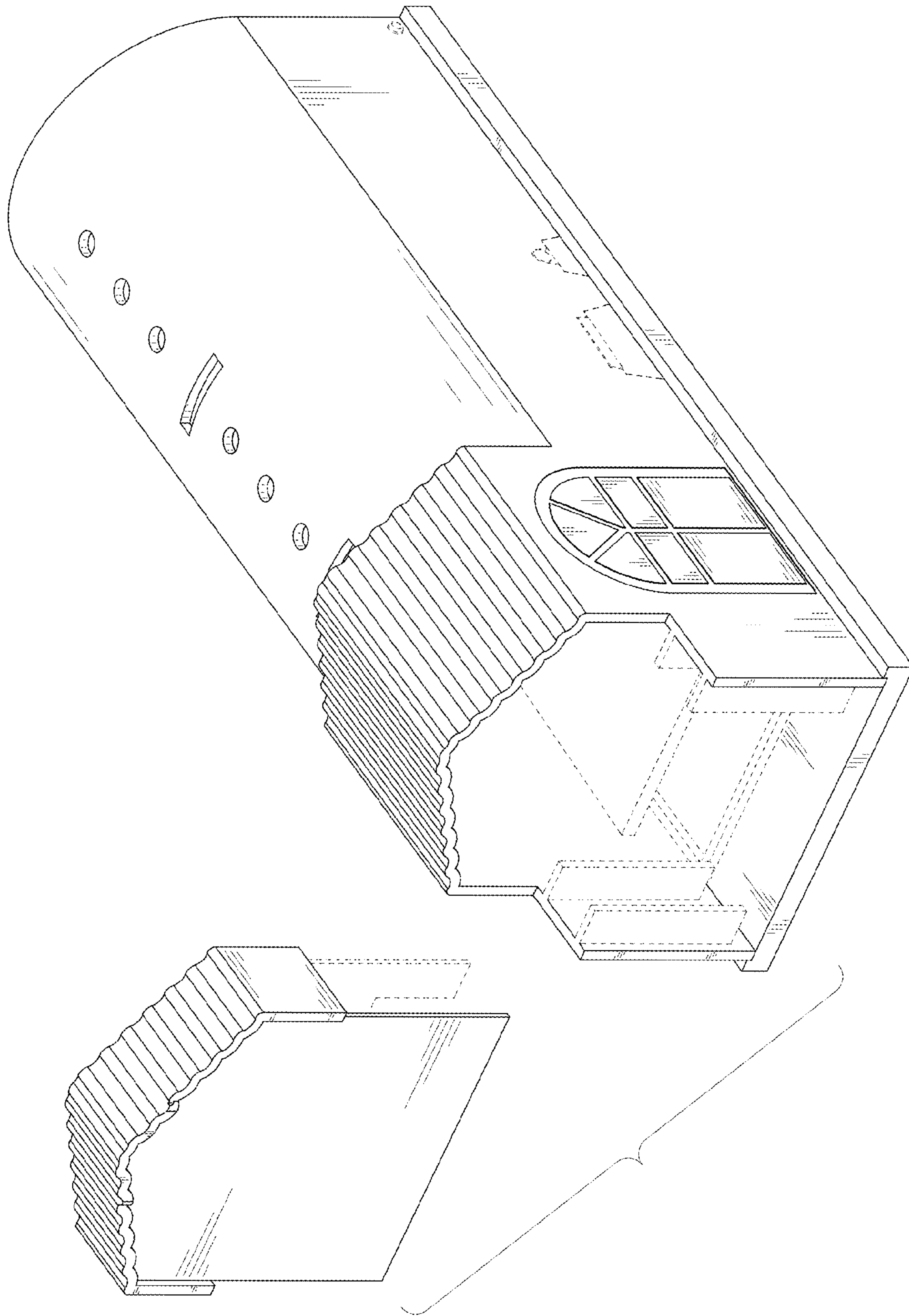

FIG. 11