



US00D948603S

(12) **United States Design Patent**
Rannells et al.

(10) **Patent No.:** **US D948,603 S**
(45) **Date of Patent:** **** Apr. 12, 2022**

(54) **OUTDOOR MUSICAL INSTRUMENT**

- (71) Applicant: **PlayCore Wisconsin, Inc.**,
Chattanooga, TN (US)
- (72) Inventors: **Joshua Rannells**, Eau Claire, WI (US);
Richard Cooke, Hesperus, CO (US);
Lindsay Hill, Chattanooga, TN (US);
Kate Morrison, Signal Mountain, TN (US)
- (73) Assignee: **PLAYCORE WISCONSIN, INC.**,
Chattanooga, TN (US)
- (**) Term: **15 Years**
- (21) Appl. No.: **29/756,165**
- (22) Filed: **Oct. 26, 2020**
- (51) **LOC (13) Cl.** **17-04**
- (52) **U.S. Cl.**
USPC **D17/22**
- (58) **Field of Classification Search**
USPC D17/22, 99; D21/405

(56) **References Cited**

U.S. PATENT DOCUMENTS

- D207,605 S * 5/1967 Van D17/22
 - D362,819 S * 10/1995 Stannard D10/118.1
- (Continued)

FOREIGN PATENT DOCUMENTS

- CA 3001700 A1 * 4/2017 G10D 13/28
- JP 2007025581 A * 2/2007 G10D 13/02

OTHER PUBLICATIONS

Freio Music.com. <https://freiomusic.com/blog/shambhala-photos/>.
“Swoon for Shambhala Music Festival in Our Magical Moments
Photo Gallery”. Sep. 2018 (Year: 2018).*

(Continued)

Primary Examiner — R. Johnson

(74) *Attorney, Agent, or Firm* — McAndrews, Held & Malloy, Ltd.

(57) **CLAIM**

The ornamental design for an outdoor musical instrument, as shown and described.

DESCRIPTION

The patent file contains at least one drawing executed in color. Copies of this patent with color drawings will be provided by the Office upon request and payment of the necessary fee.

FIG. 1 is a top, front perspective view of an outdoor musical instrument showing my new design according to a first embodiment;

FIG. 2 is a front elevation view thereof;

FIG. 3 is a rear elevation view thereof;

FIG. 4 is a right side elevation view thereof;

FIG. 5 is a left side elevation view thereof;

FIG. 6 is a top plan view thereof;

FIG. 7 is a bottom plan view thereof;

FIG. 8 is a bottom, rear perspective view thereof;

FIG. 9 is a top, front perspective view of an outdoor musical instrument showing my new design according to a second embodiment;

FIG. 10 is a front elevation view thereof;

FIG. 11 is a rear elevation view thereof;

FIG. 12 is a right side elevation view thereof;

FIG. 13 is a left side elevation view thereof;

FIG. 14 is a top plan view thereof;

FIG. 15 is a bottom plan view thereof;

FIG. 16 is a bottom, rear perspective view thereof;

FIG. 17 is a top, front perspective view of an outdoor musical instrument showing my new design according to a third embodiment;

FIG. 18 is a front elevation view thereof;

FIG. 19 is a rear elevation view thereof;

FIG. 20 is a right side elevation view thereof;

FIG. 21 is a left side elevation view thereof;

FIG. 22 is a top plan view thereof;

FIG. 23 is a bottom plan view thereof; and,

FIG. 24 is a bottom, rear perspective view thereof.

The evenly dashed broken lines in the drawings illustrate portions of the outdoor musical instrument that form no part of the claimed design.

The red and white color on the cap portion of the outdoor musical instrument forms part of the claimed design; the

(Continued)

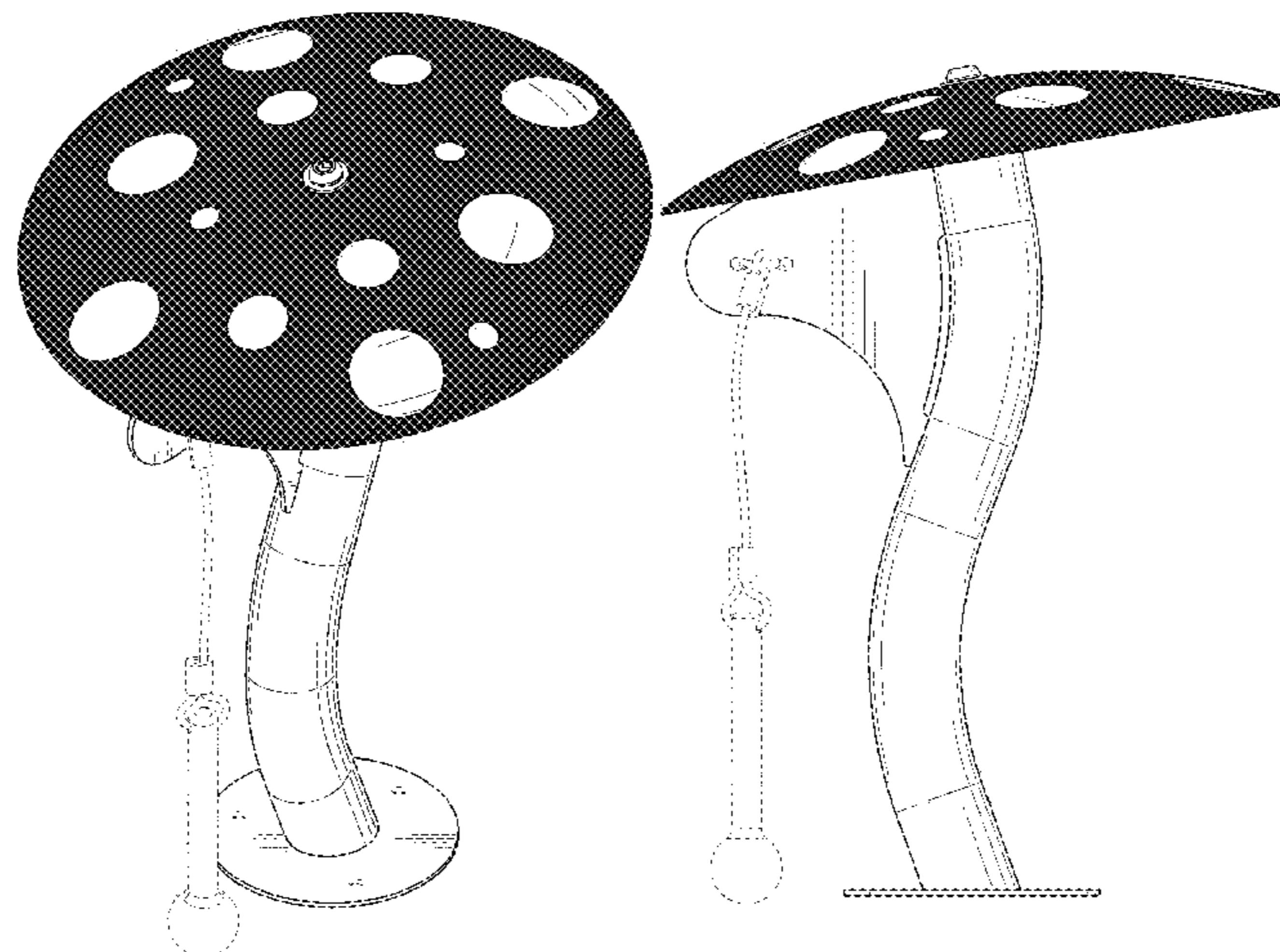

color of the other portions of the outdoor musical instrument form no part of the claimed design.

**1 Claim, 24 Drawing Sheets
(24 of 24 Drawing Sheet(s) Filed in Color)**

(58) **Field of Classification Search**

CPC G10D 13/00; G10D 13/01; G10D 13/02;
G10D 13/03; G10D 13/10

See application file for complete search history.

(56) **References Cited**

U.S. PATENT DOCUMENTS

D471,581 S * 3/2003 Brady D17/22
D504,706 S * 5/2005 Bennett D21/398
10,373,594 B1 * 8/2019 Doe G10D 13/08
D866,491 S * 11/2019 Krishnan D13/182
D910,110 S * 2/2021 Tirabassi D17/22
D923,695 S * 6/2021 Long D17/22
2016/0253984 A1 * 9/2016 Zamarripa G10G 5/00
248/305
2019/0295516 A1 * 9/2019 Hashimoto G10D 13/22
2021/0193091 A1 * 6/2021 Jones G10D 13/06

OTHER PUBLICATIONS

DHGate. <https://www.dhgate.com/product/outdoor-ground-decoration-colorful-charming/540024212.html>. "Outdoor ground decoration Colorful charming Inflatable Mushroom with led lighting". Date Unknown: Viewed Nov. 2021 (Year: 2021).*

* cited by examiner

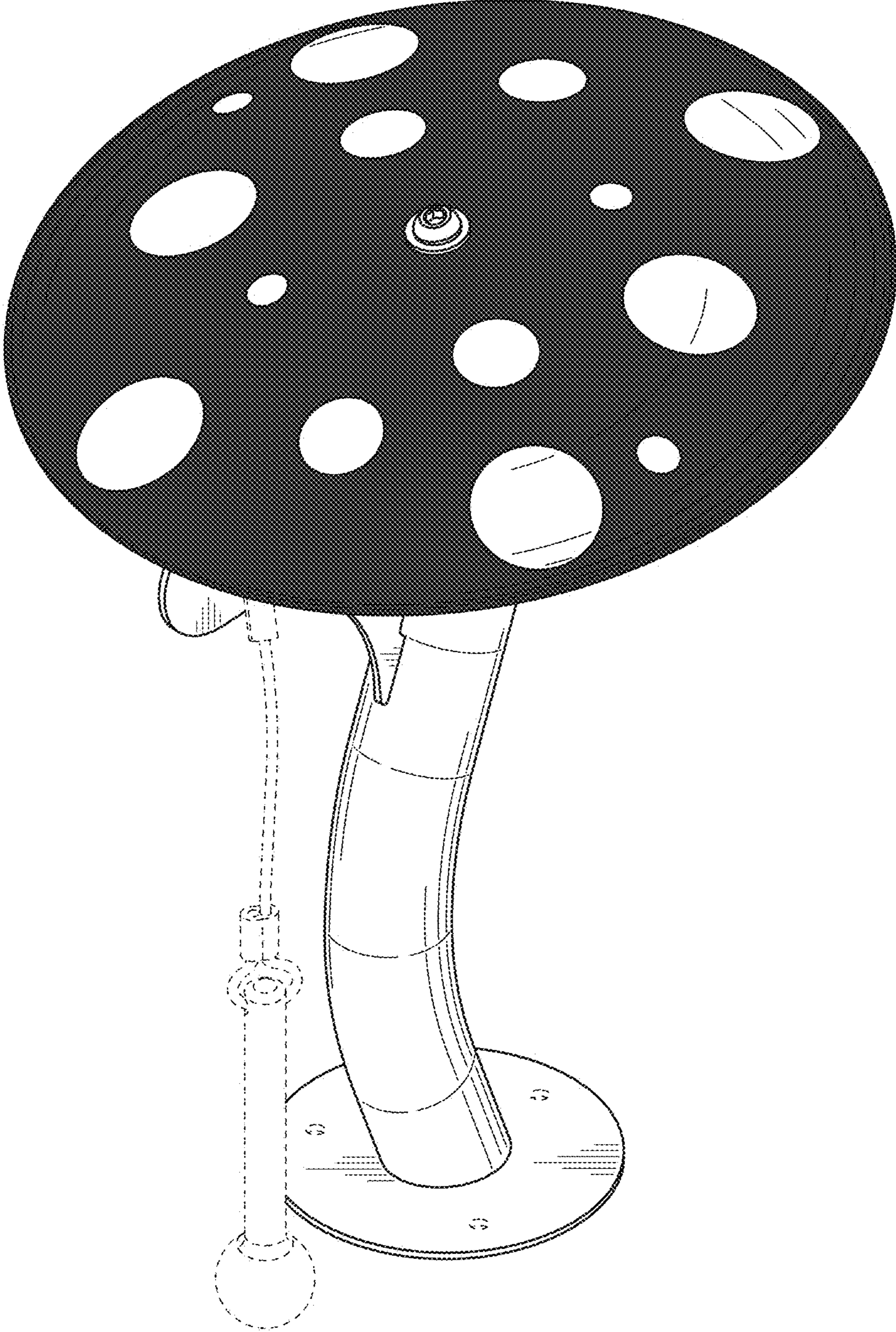

FIG. 1

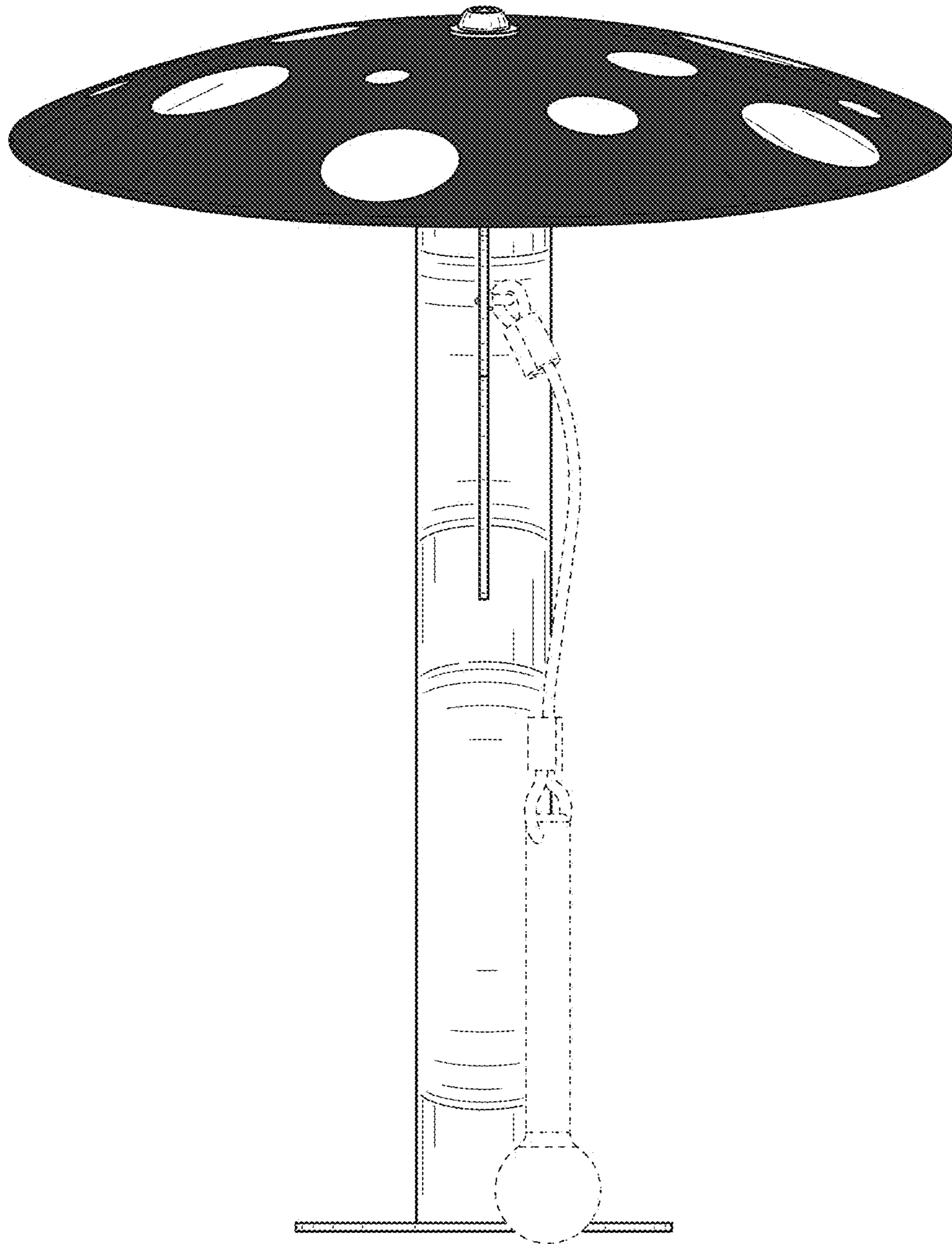

FIG. 2

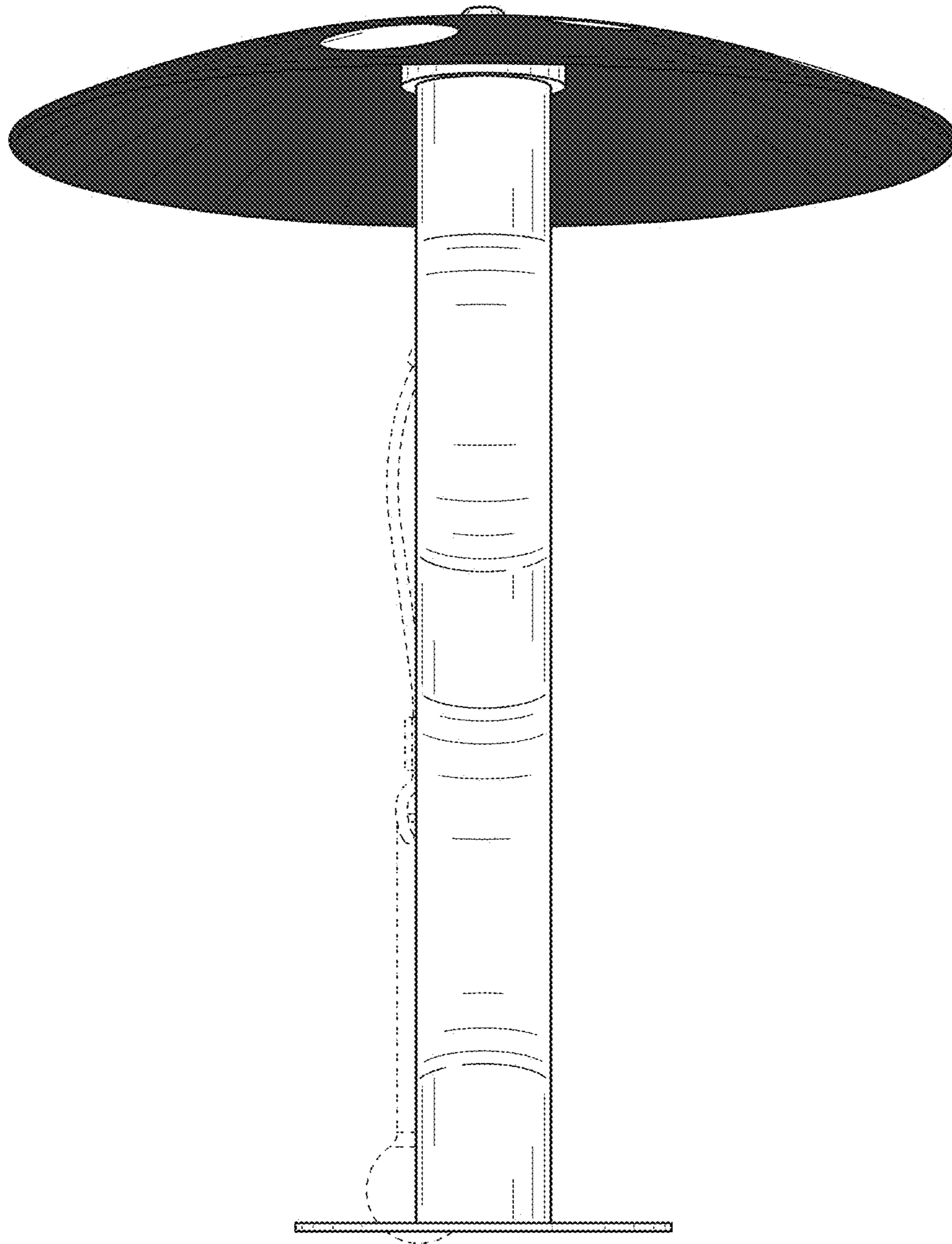

FIG. 3

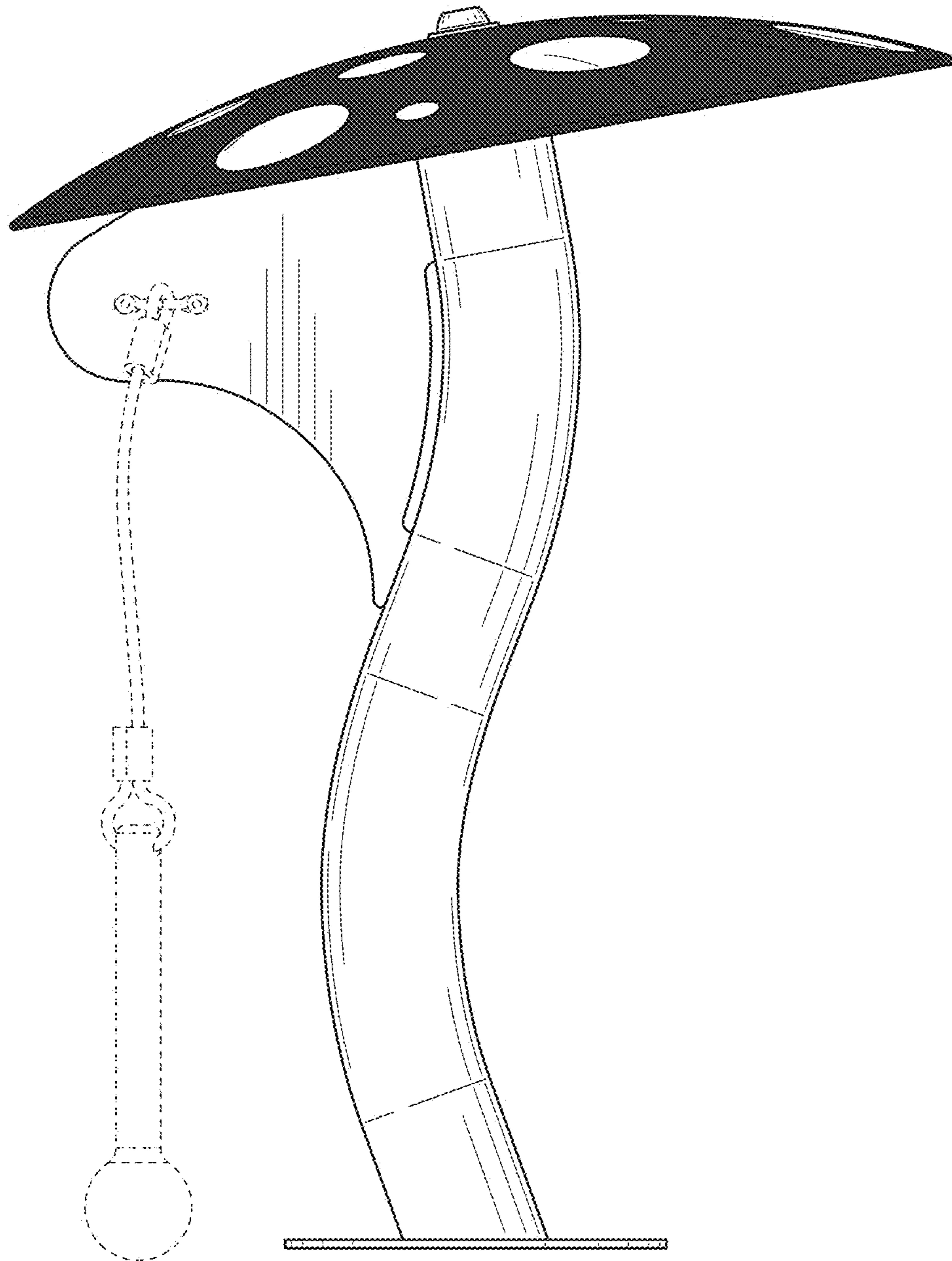

FIG. 4

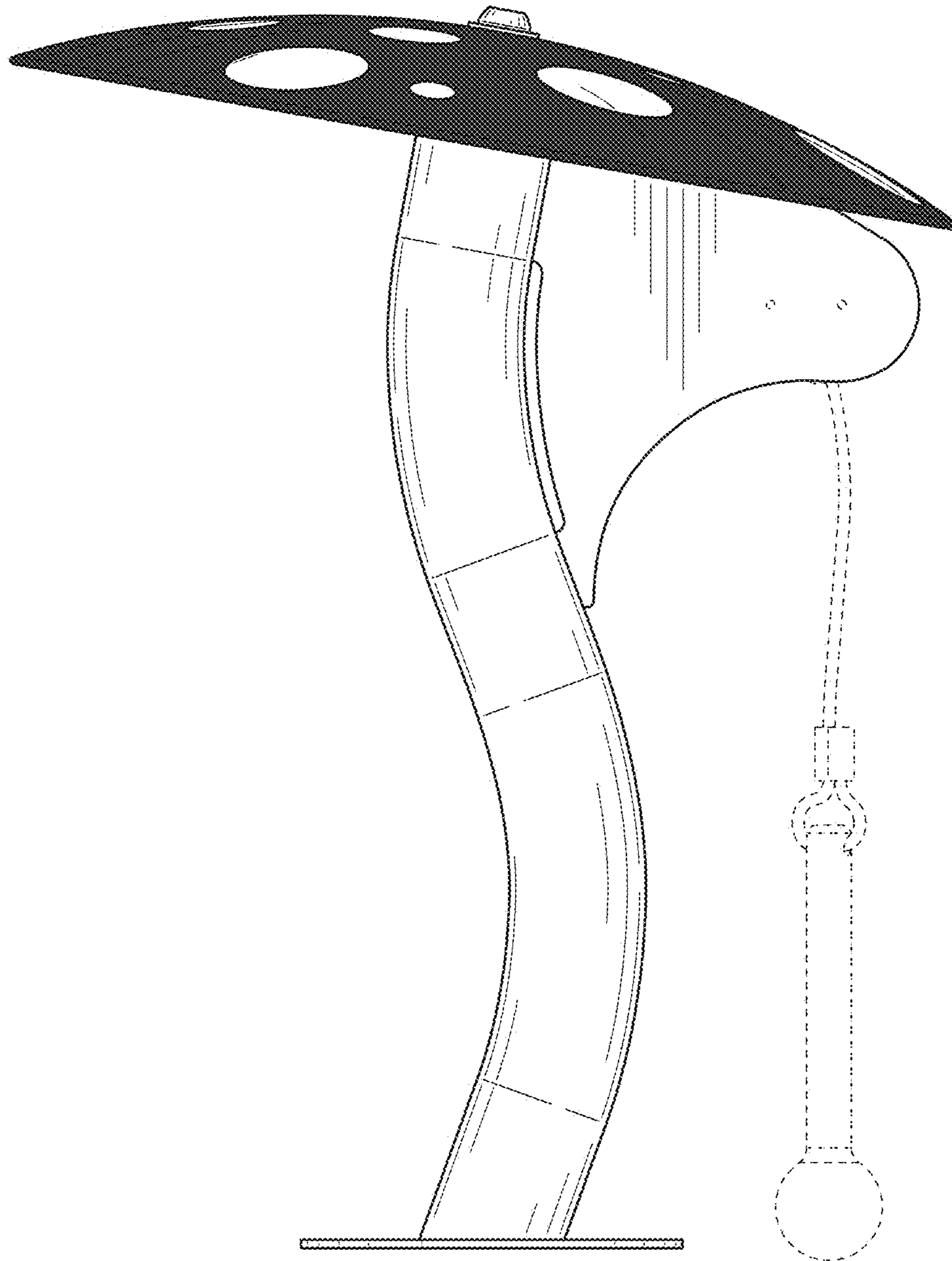

FIG. 5

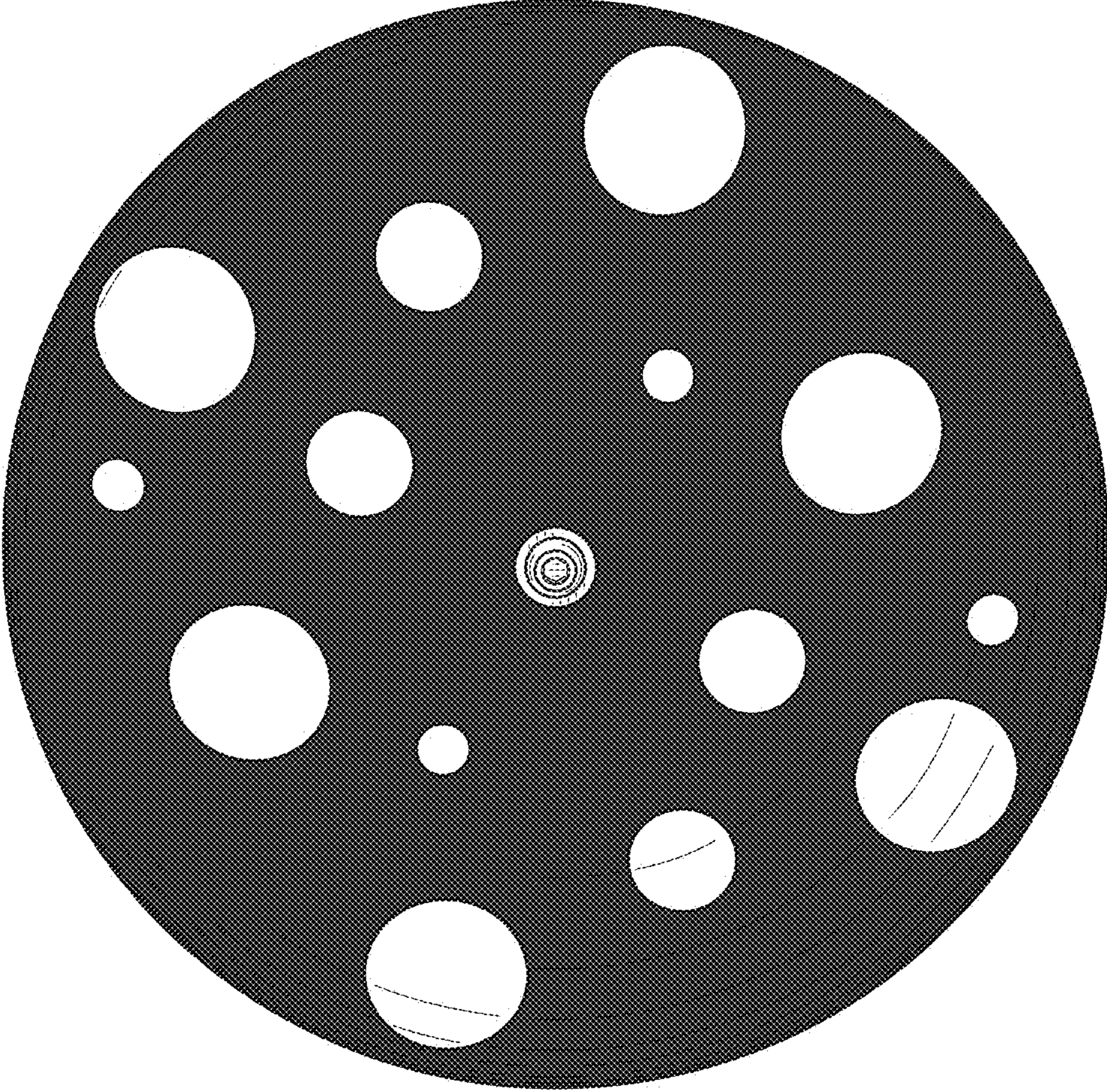

FIG. 6

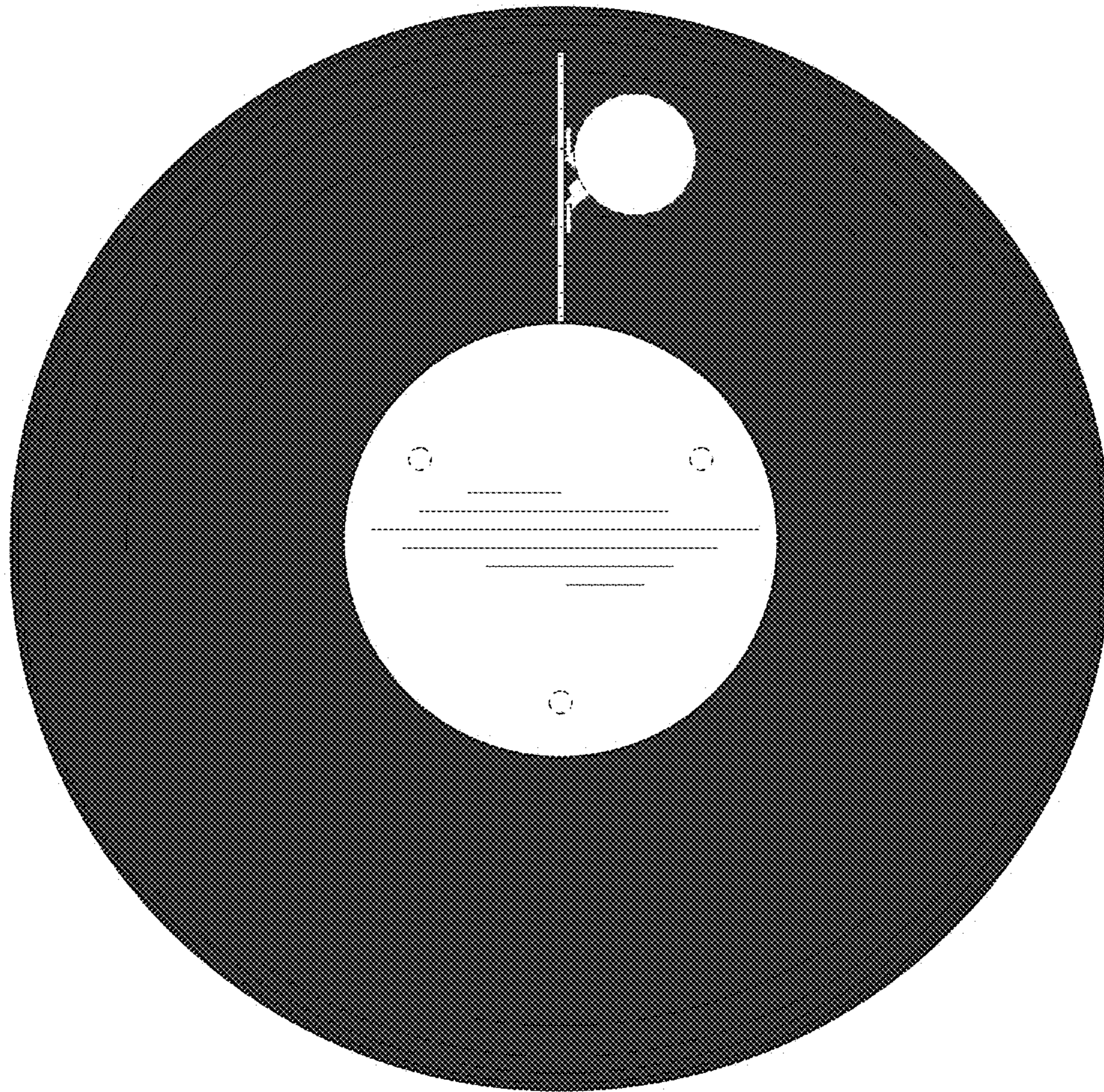

FIG. 7

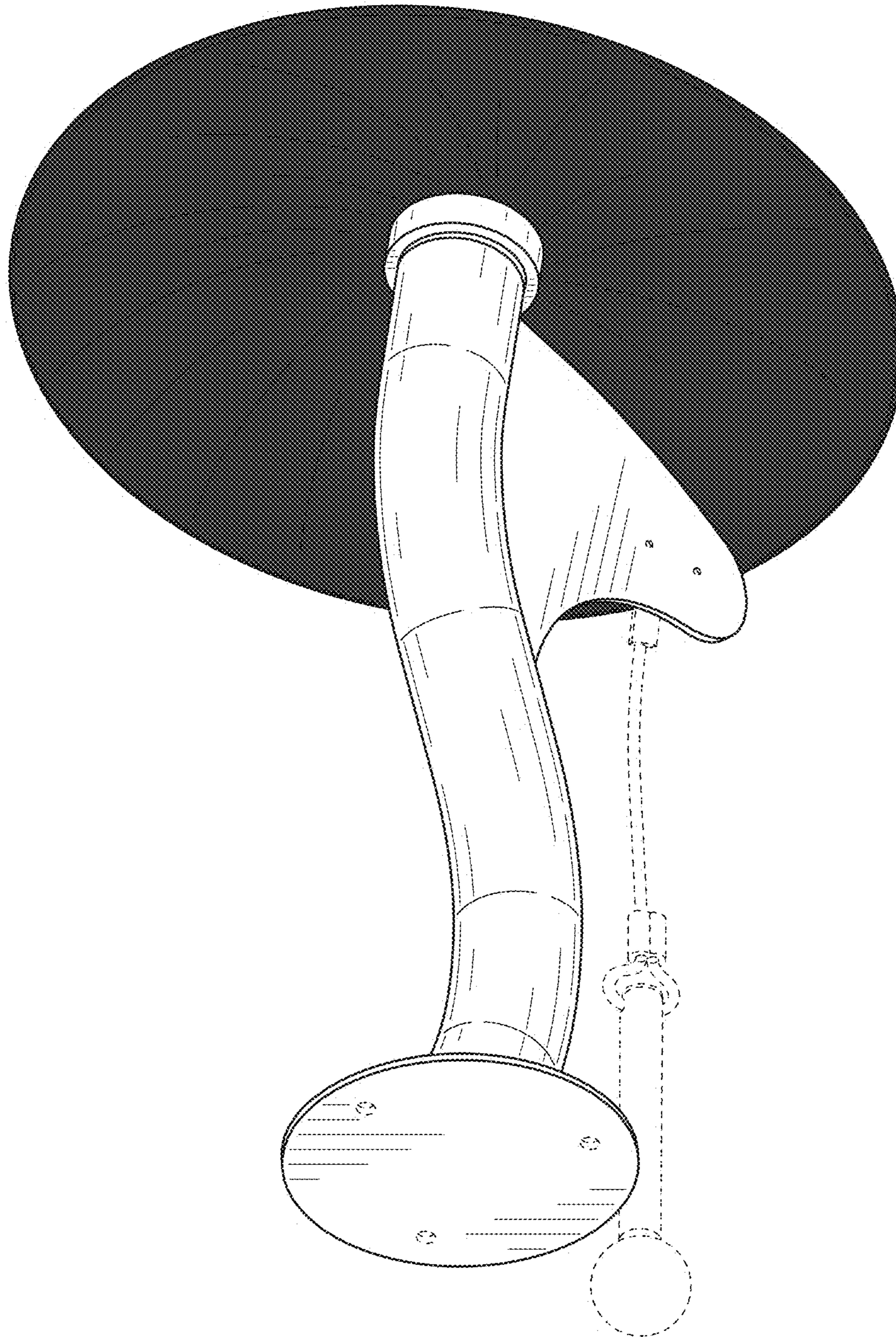

FIG. 8

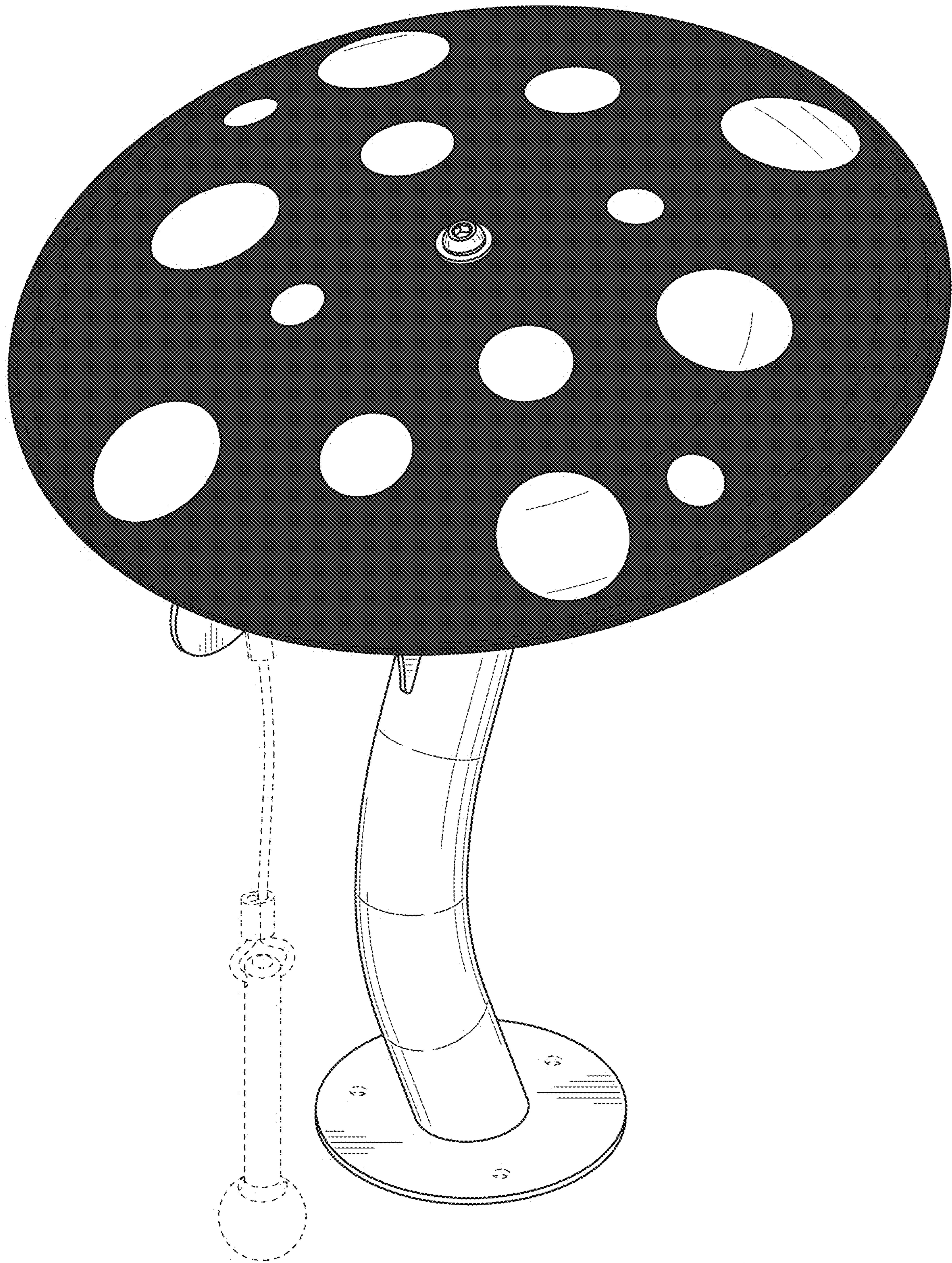

FIG. 9

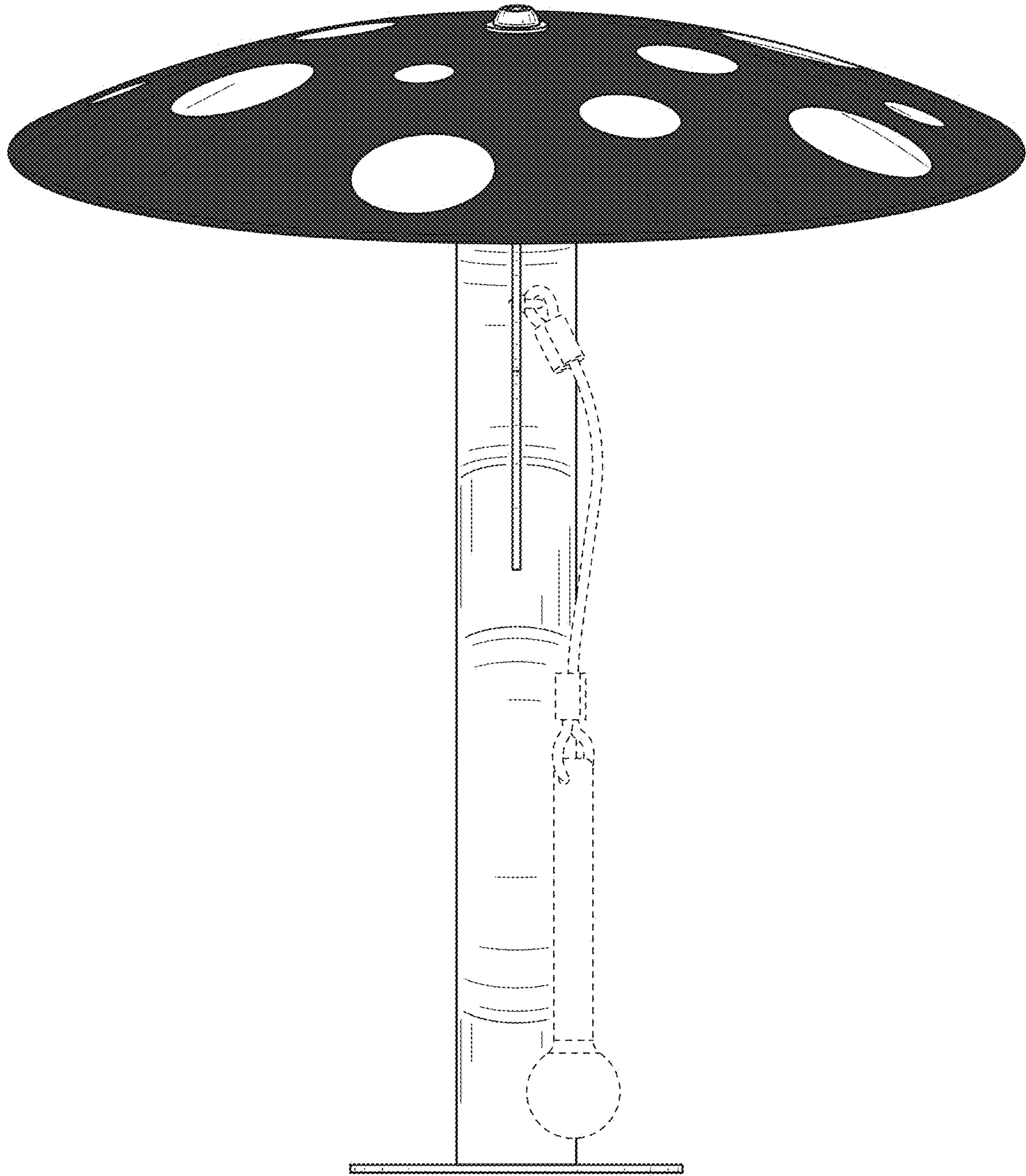

FIG. 10

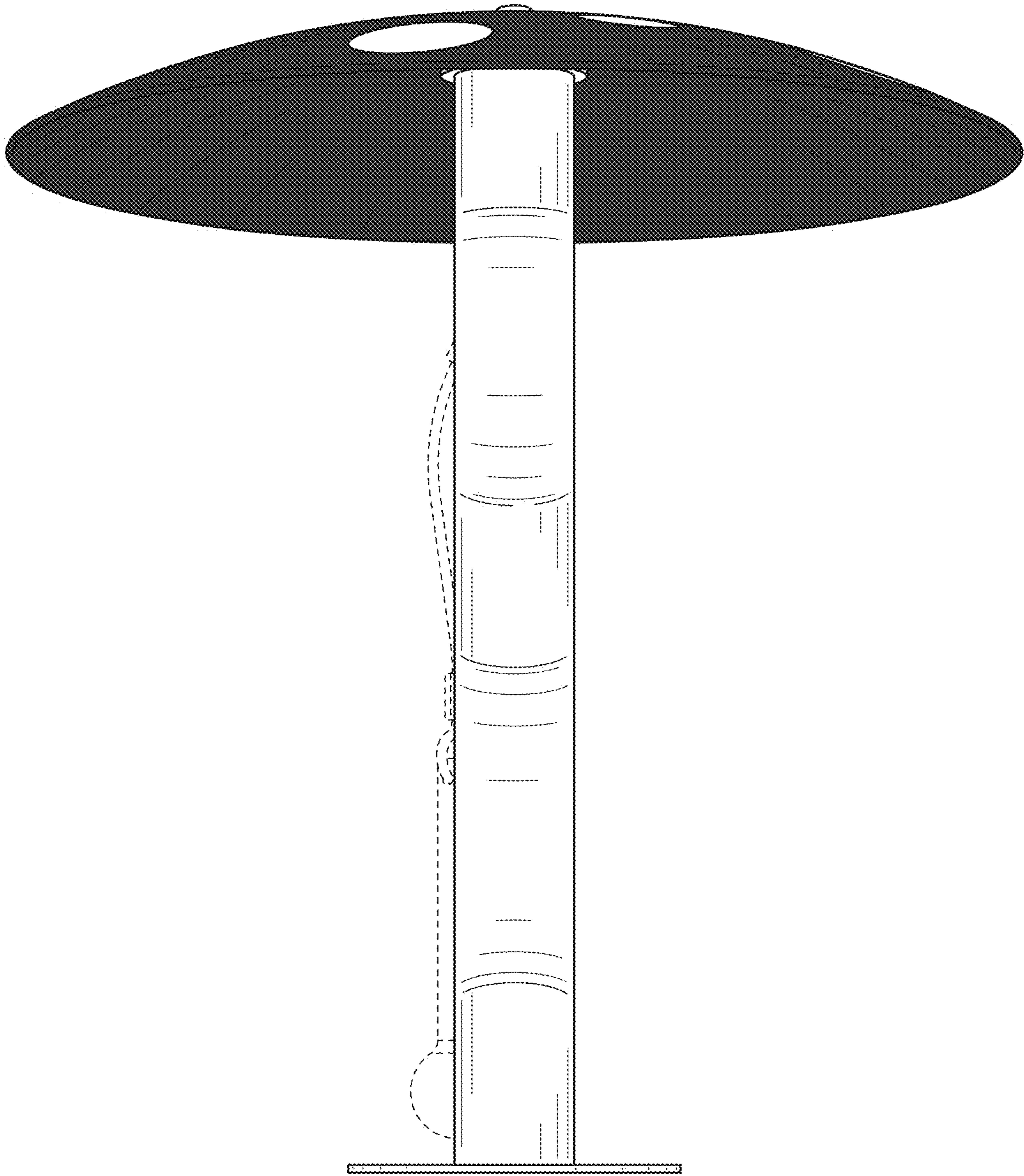

FIG. 11

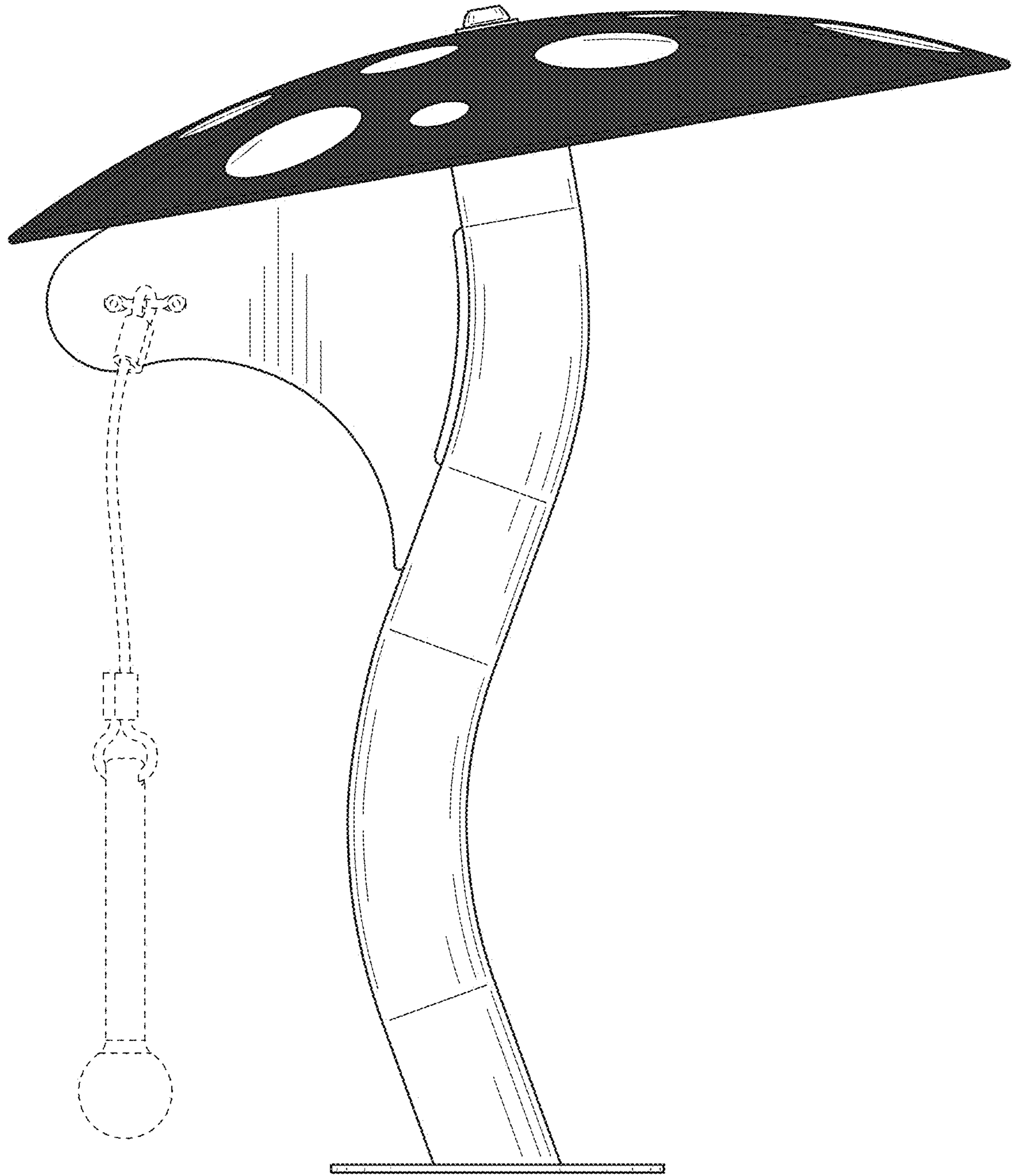

FIG. 12

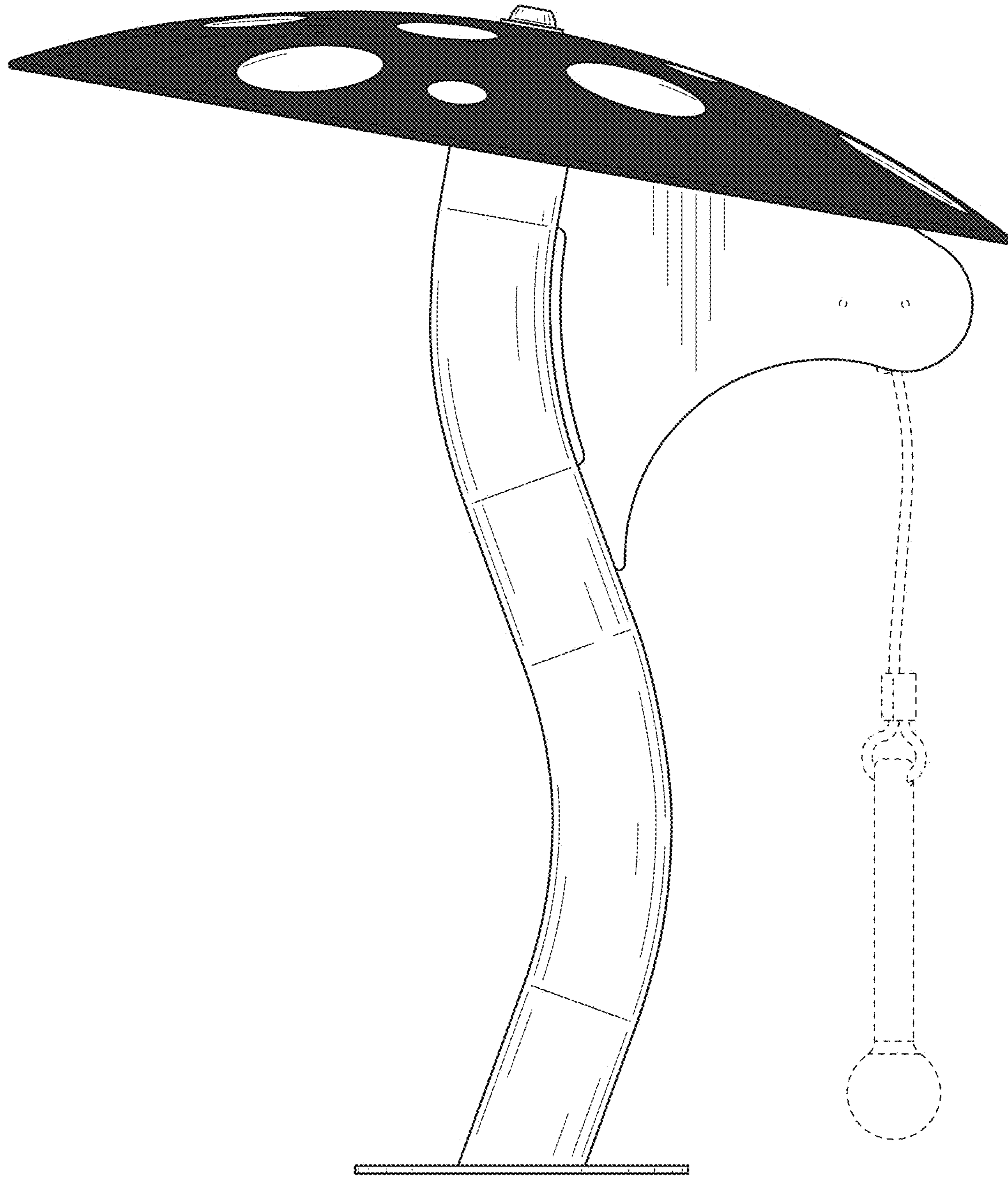

FIG. 13

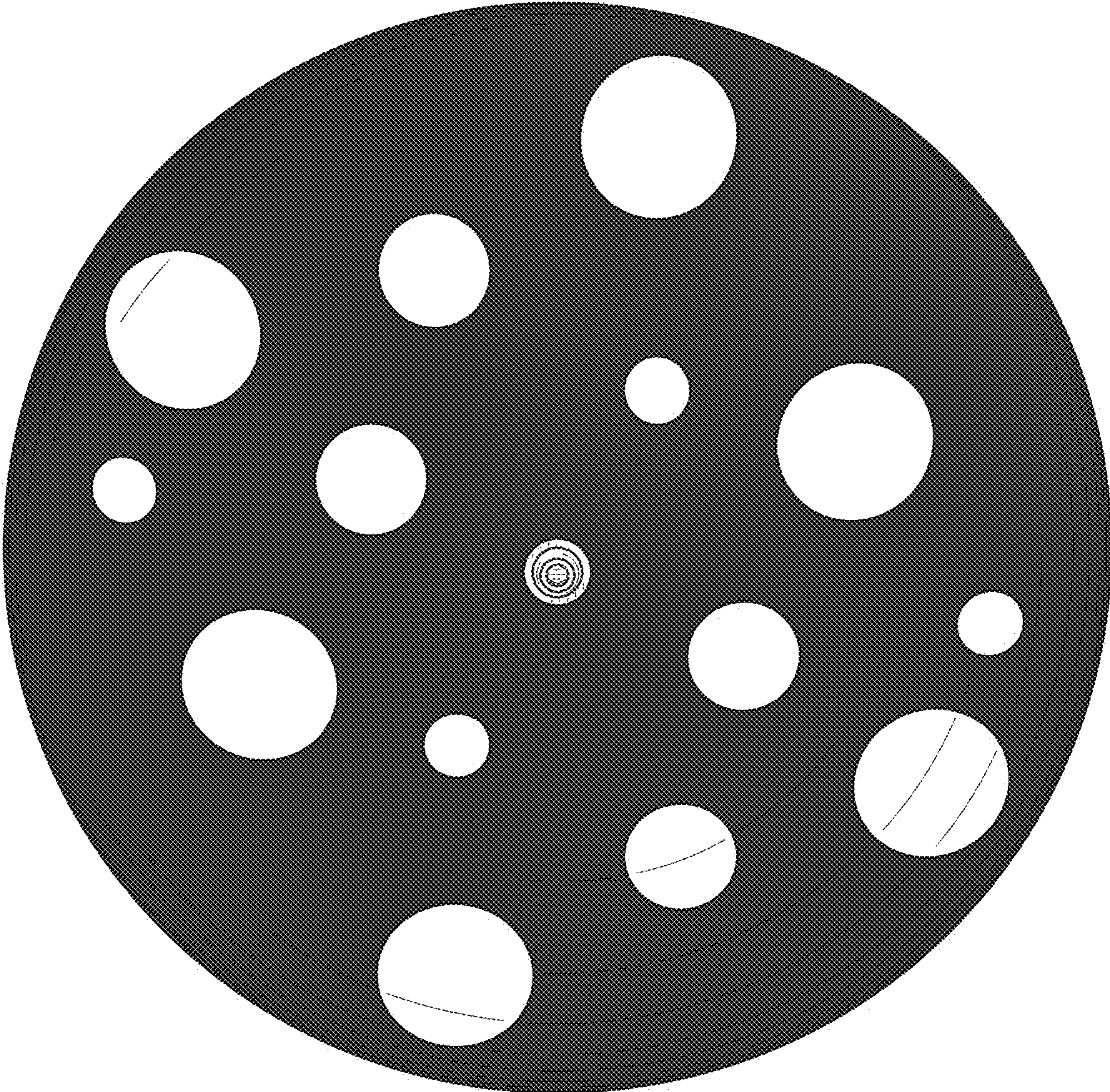

FIG. 14

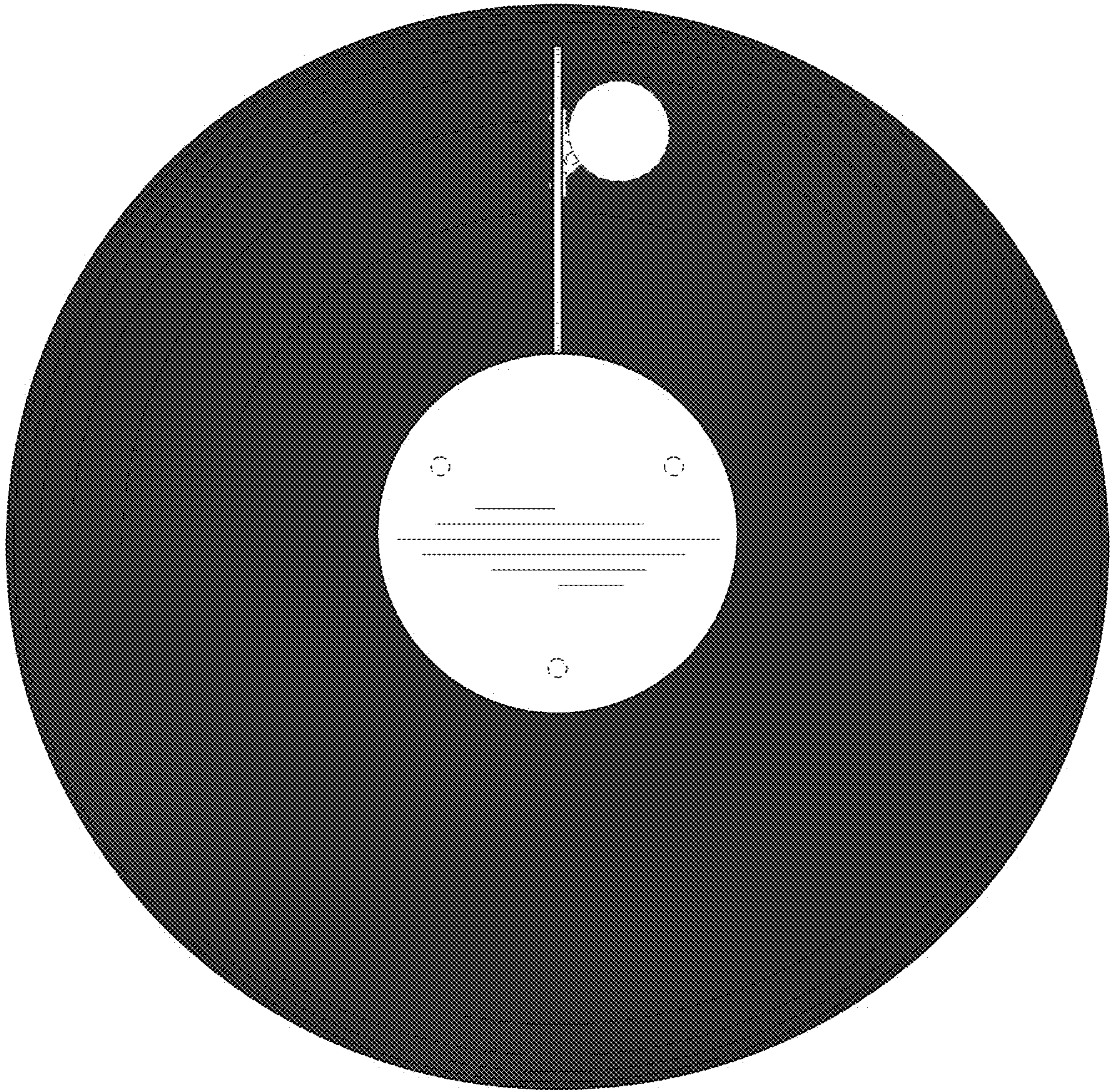

FIG. 15

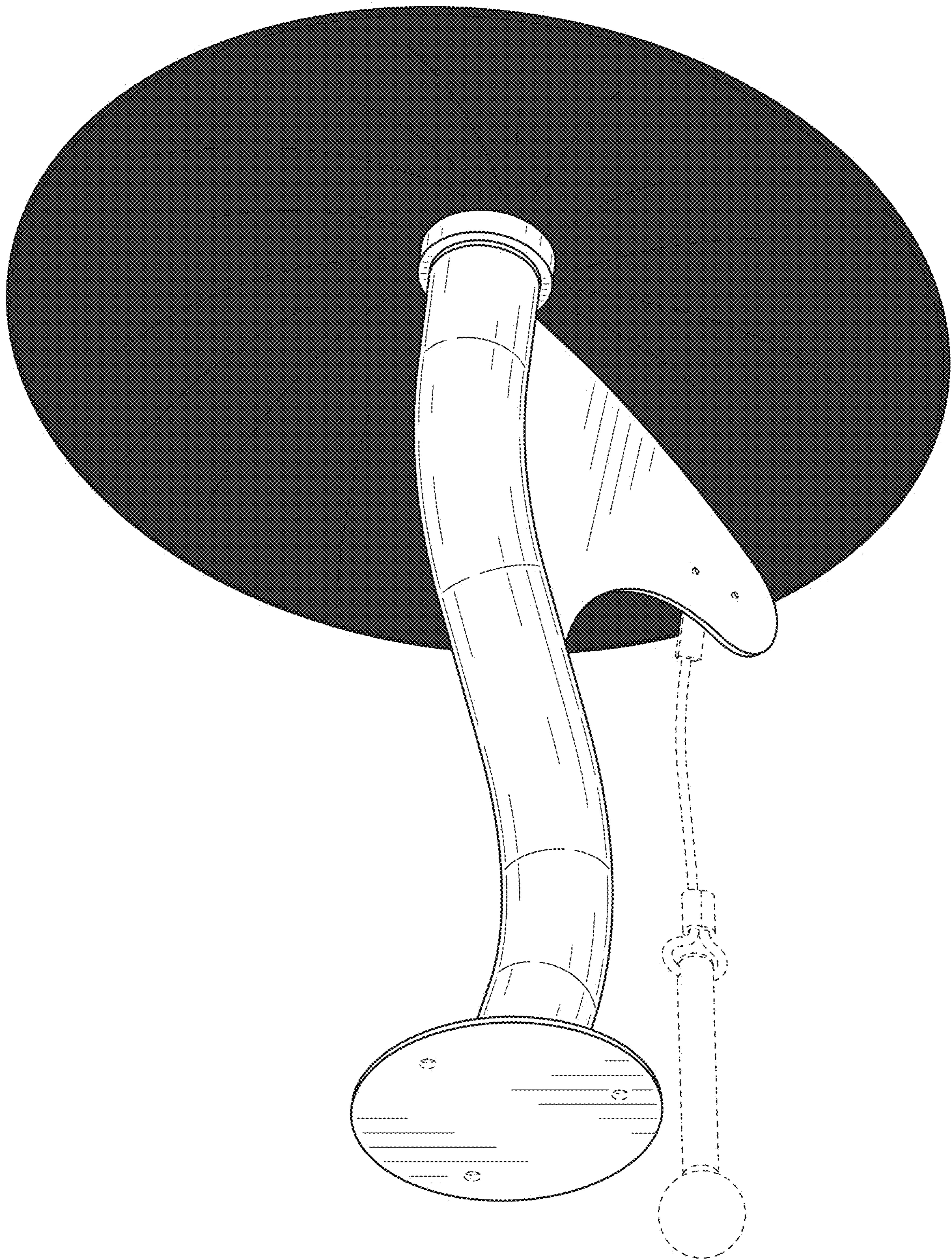

FIG. 16

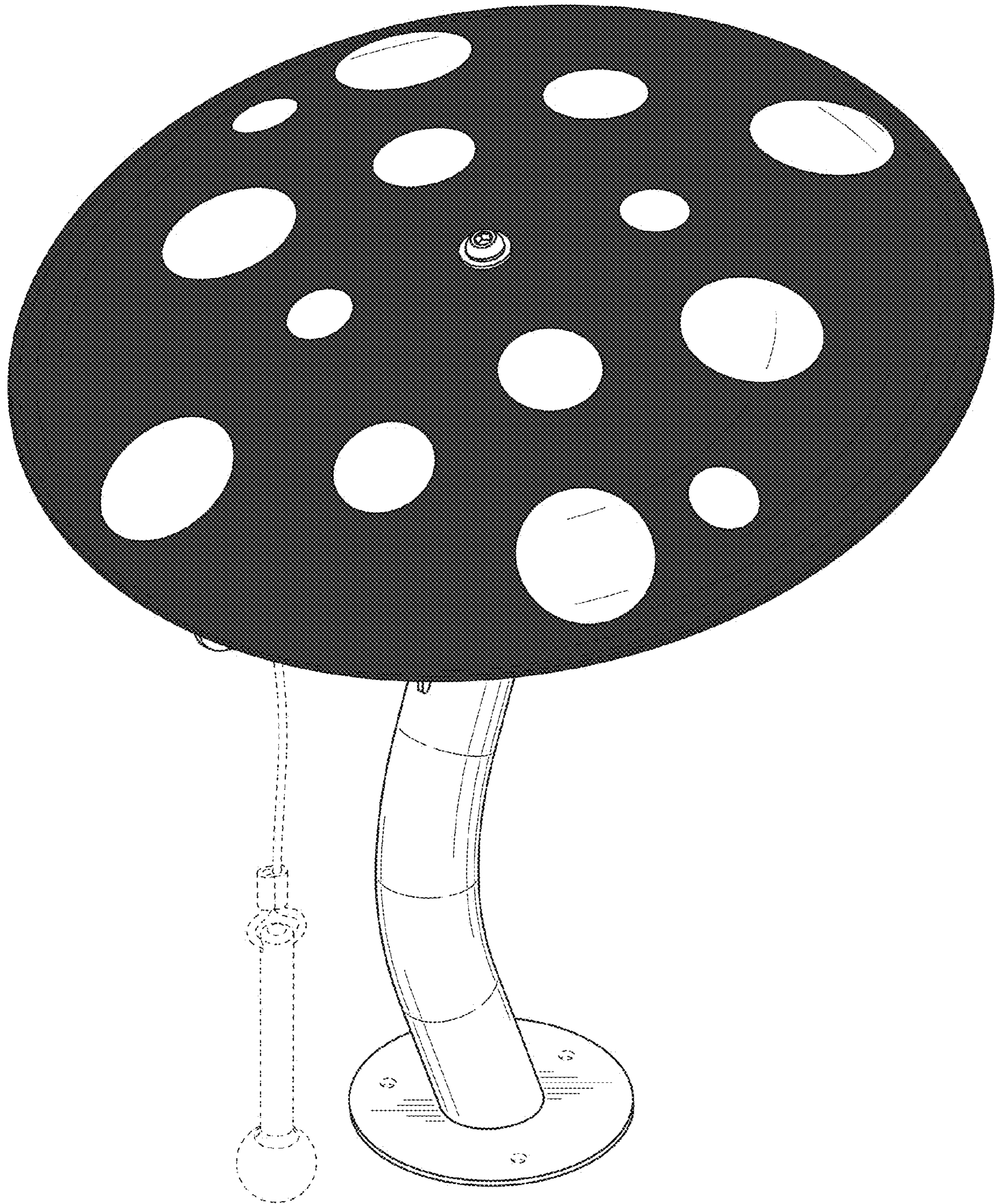

FIG. 17

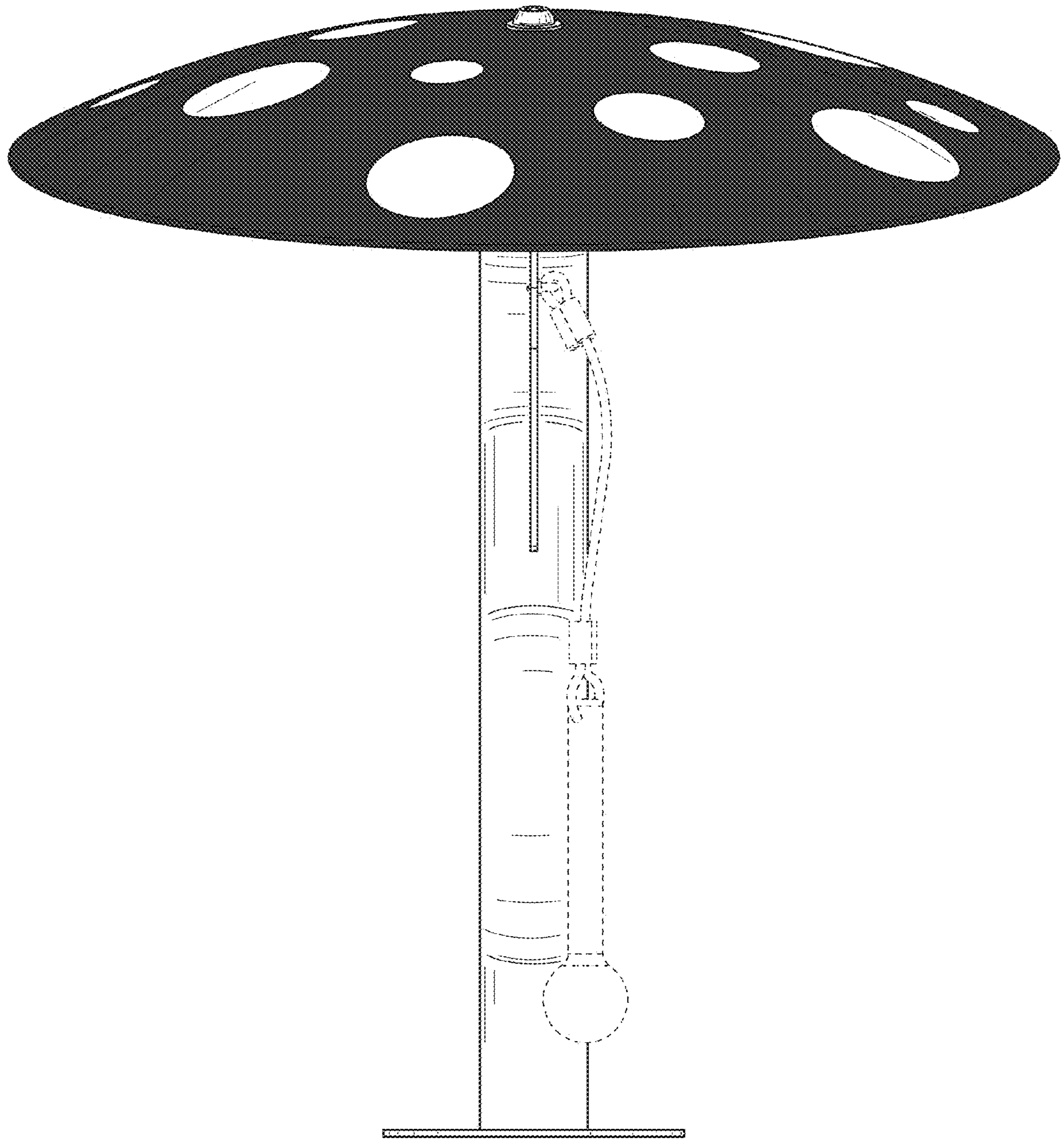

FIG. 18

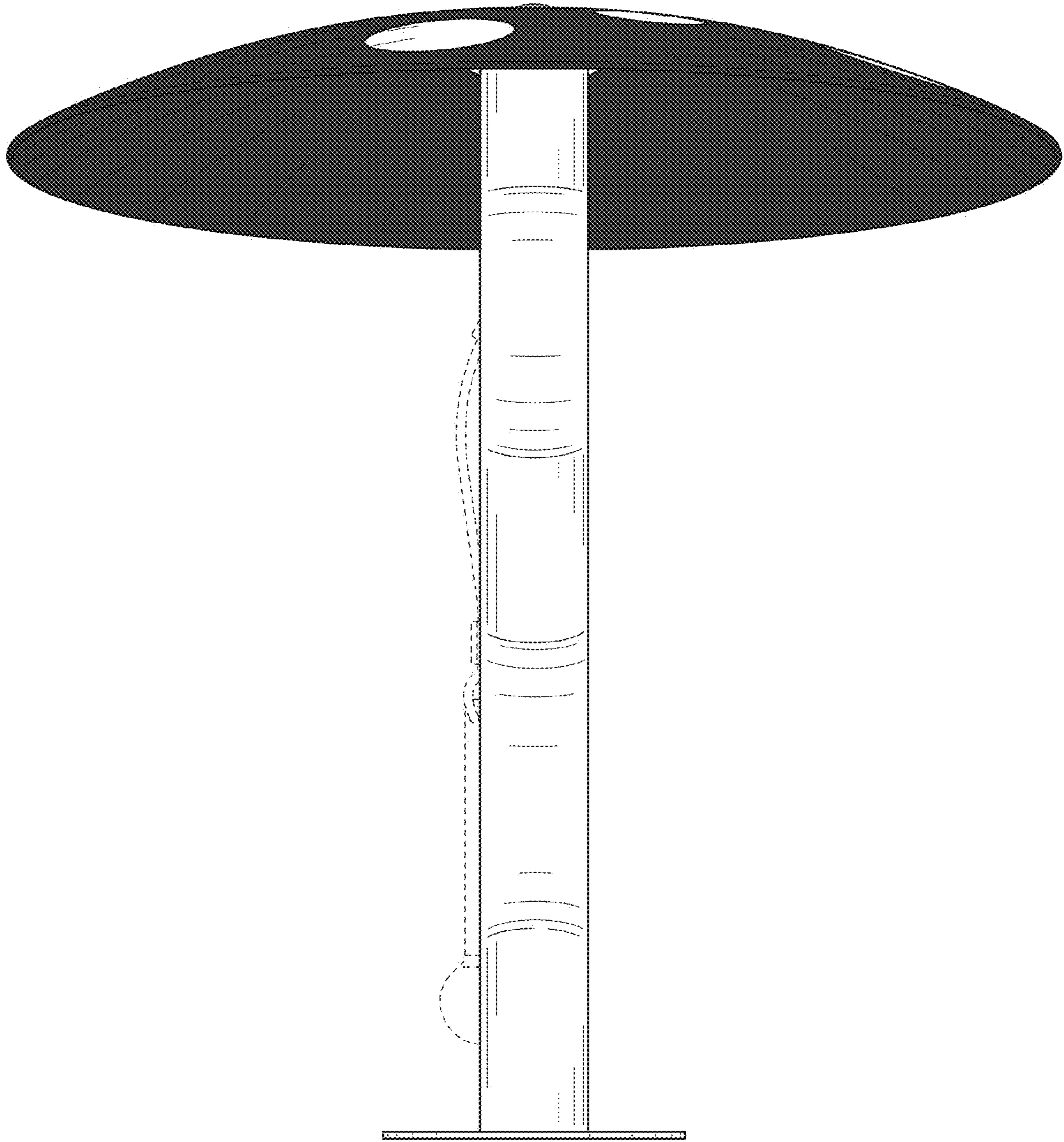

FIG. 19

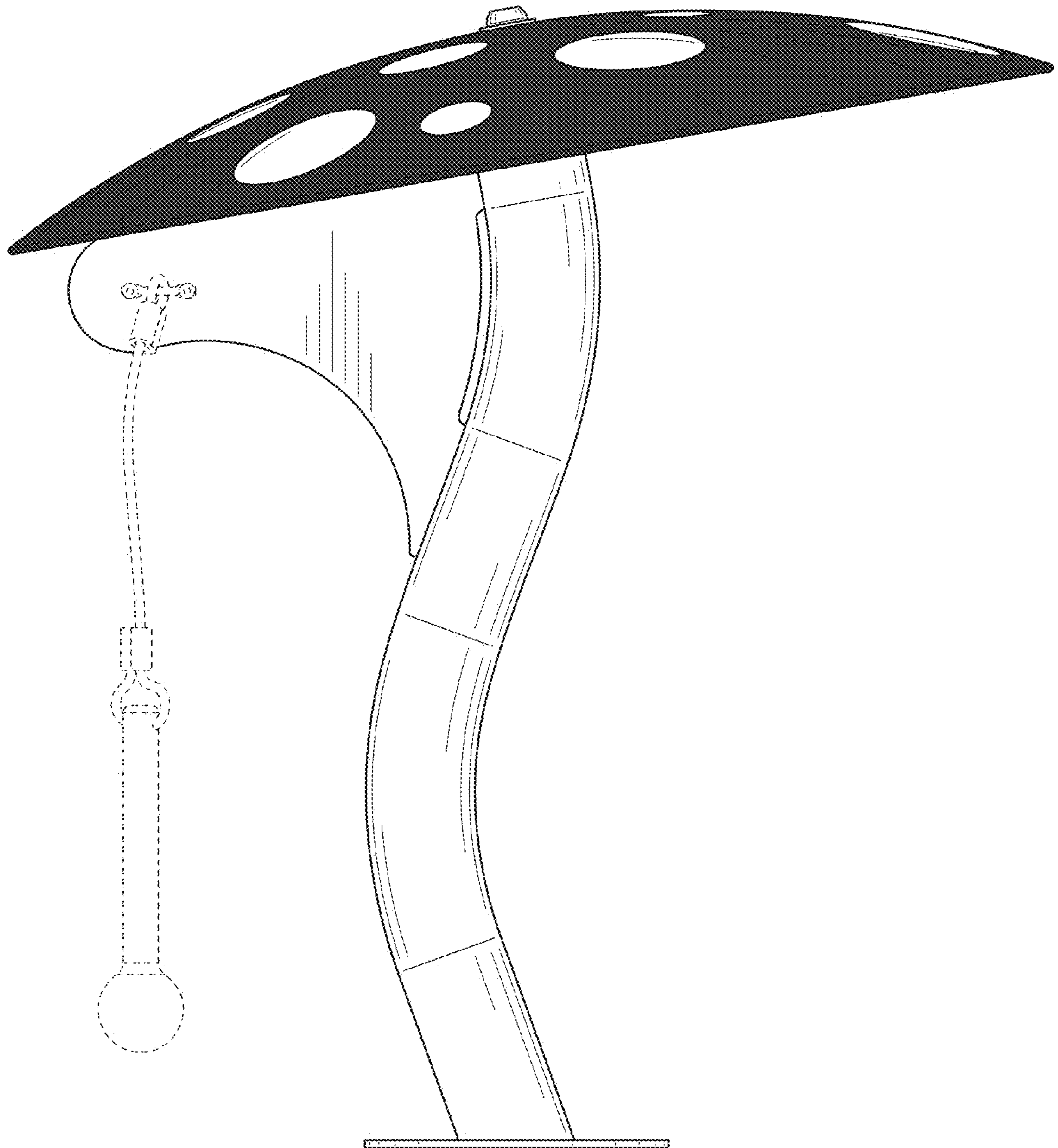

FIG. 20

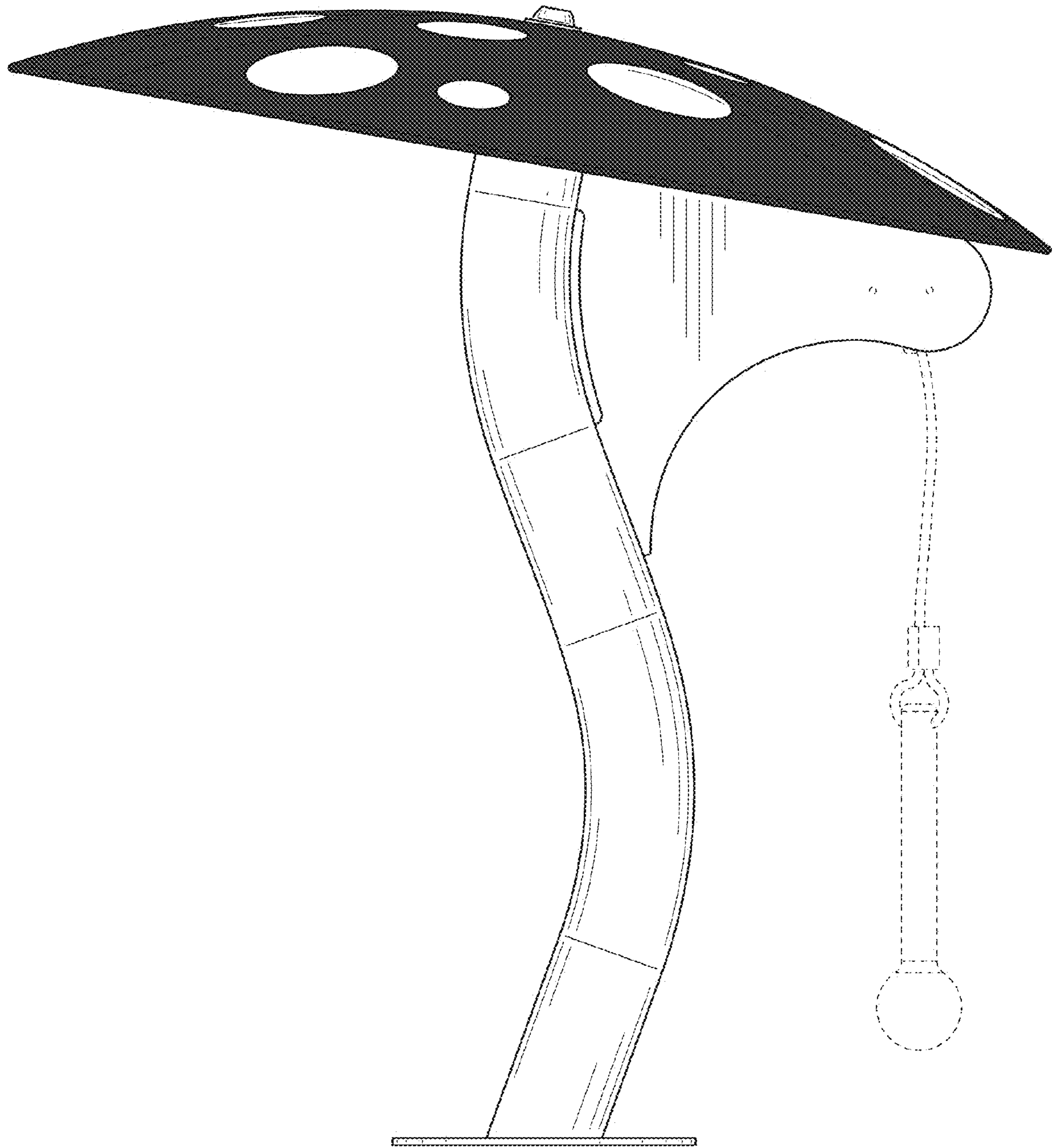

FIG. 21

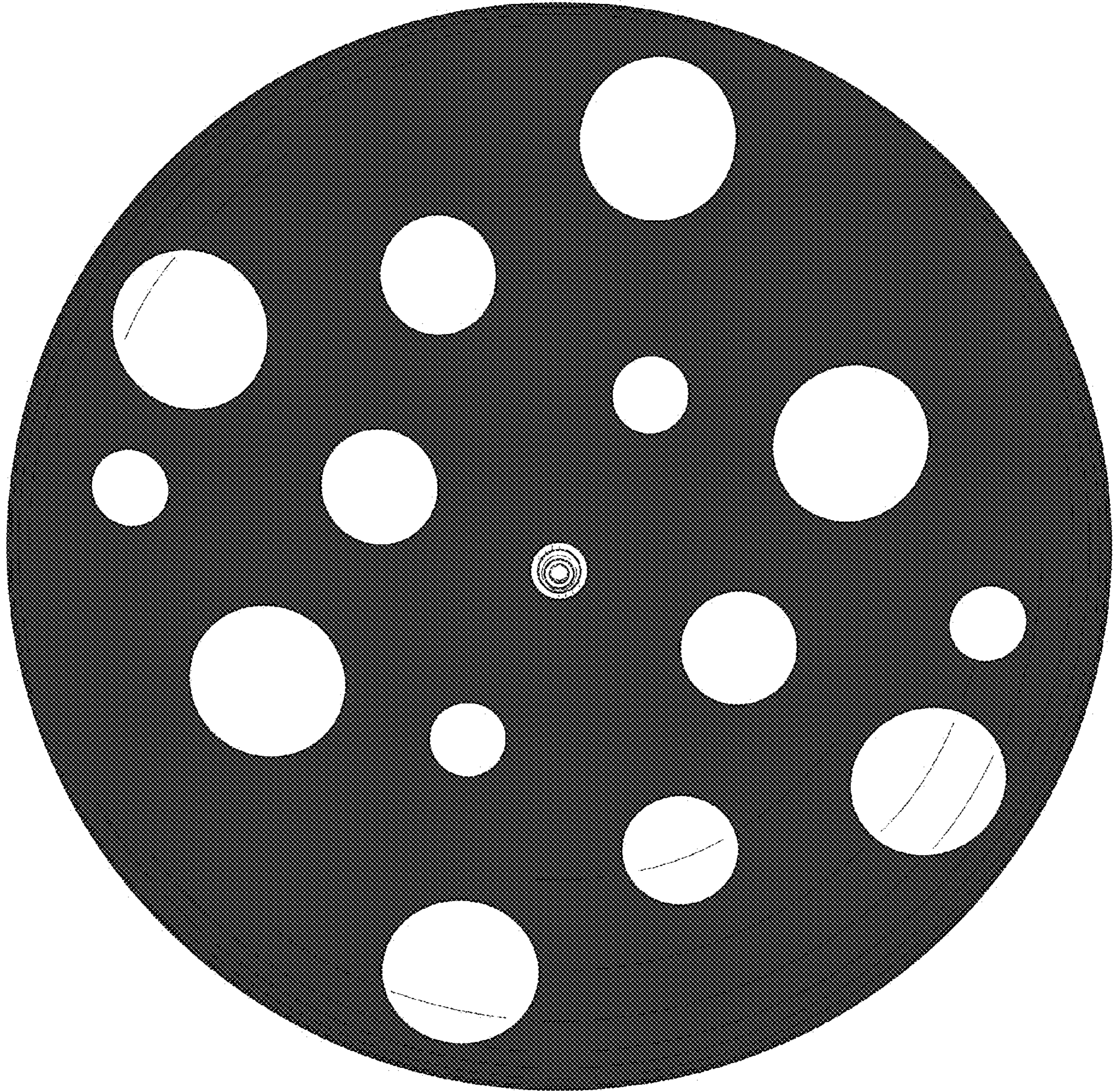

FIG. 22

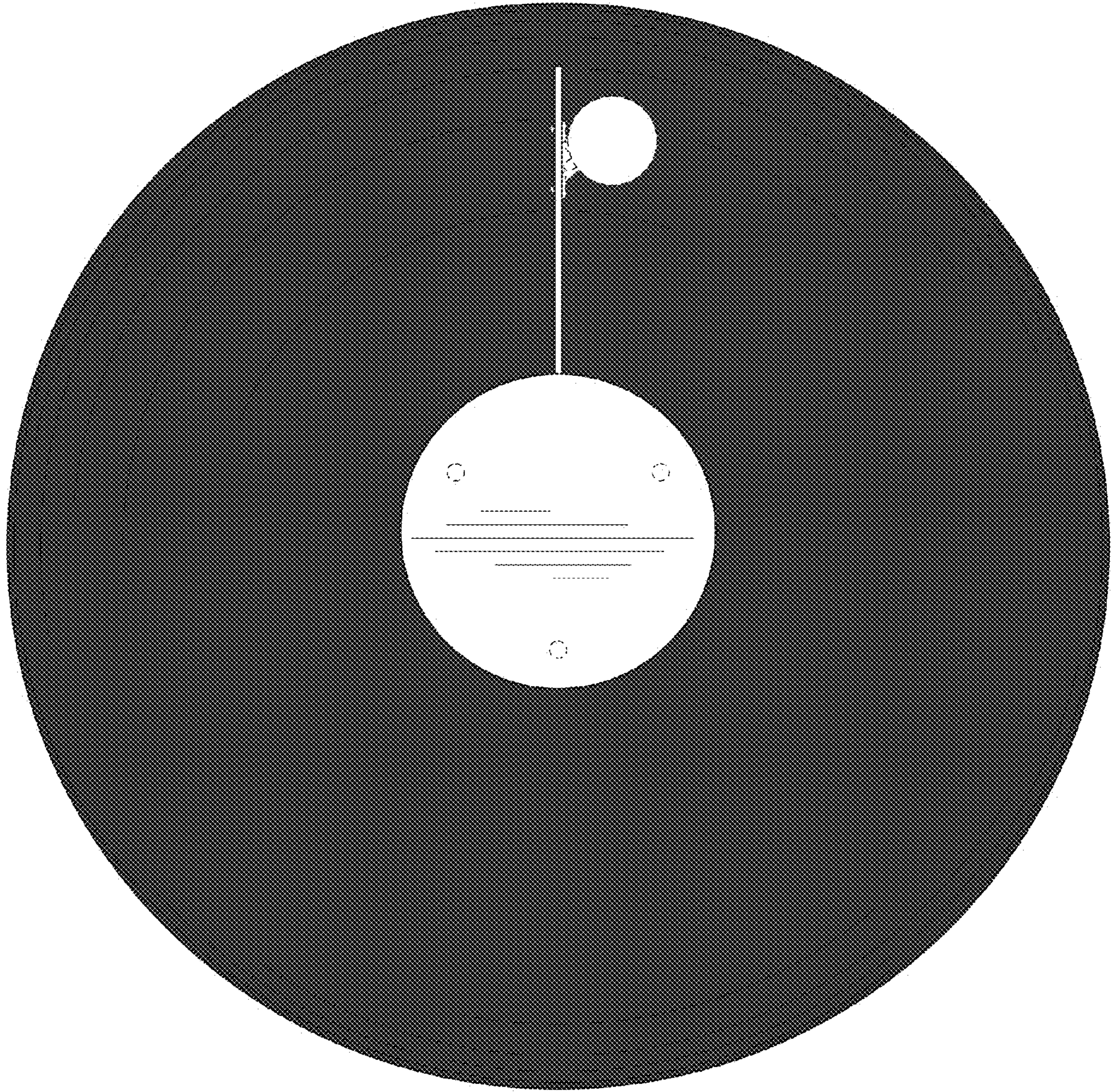

FIG. 23

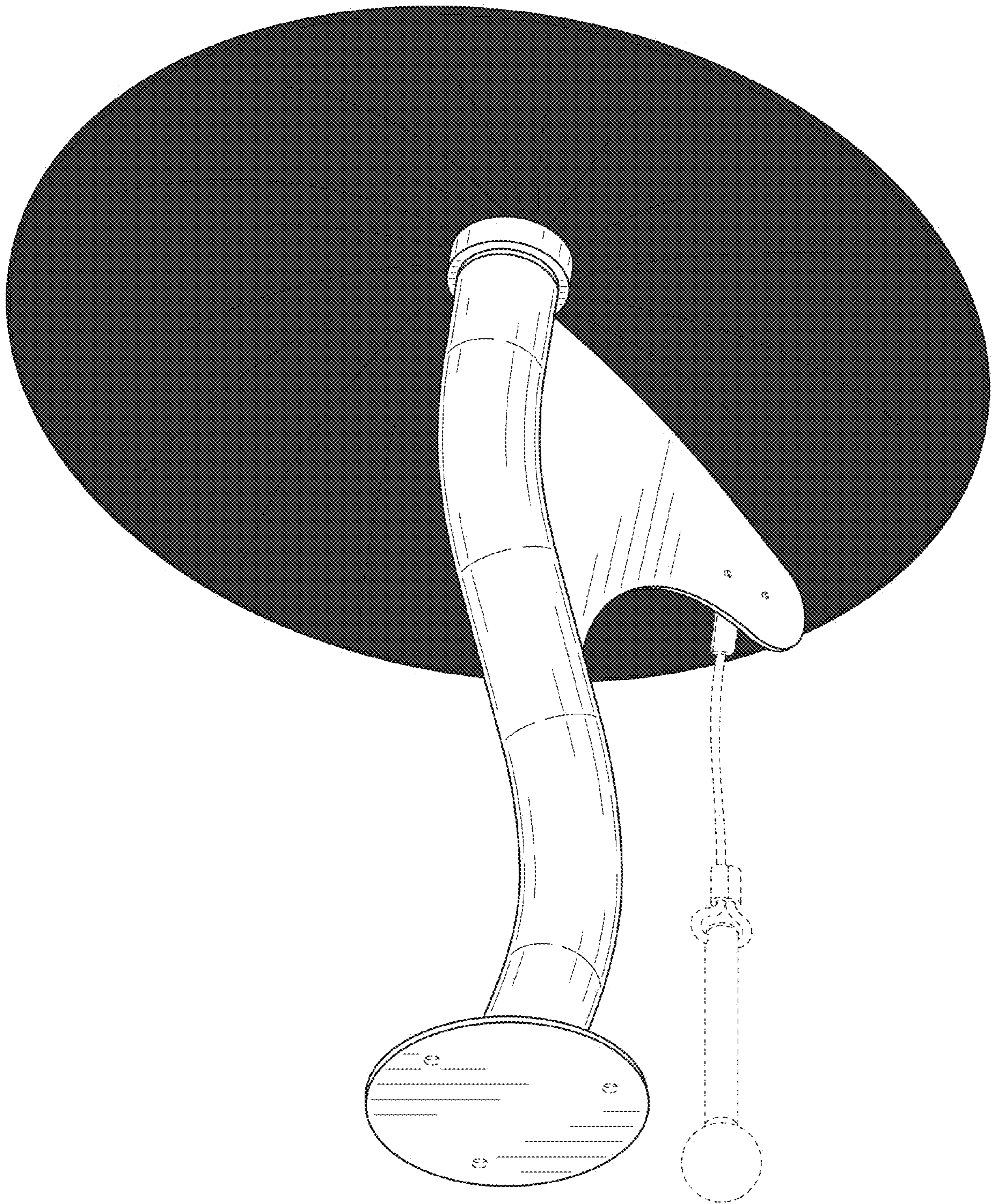

FIG. 24