



US00D948506S

(12) **United States Design Patent**
Aulert et al.

(10) **Patent No.:** **US D948,506 S**
(45) **Date of Patent:** **** Apr. 12, 2022**

(54) **SECURITY DEVICE**

(71) Applicant: **RF Ideas, Inc.**, Rolling Meadows, IL (US)

(72) Inventors: **Michael C. Aulert**, Cary, IL (US);
Rajani Pidaparti, Buffalo Grove, IL (US)

(73) Assignee: **RF Ideas, Inc.**, Rolling Meadows, IL (US)

(**) Term: **15 Years**

(21) Appl. No.: **29/745,992**

(22) Filed: **Aug. 11, 2020**

(51) **LOC (13) Cl.** **14-02**

(52) **U.S. Cl.**
USPC **D14/384**

(58) **Field of Classification Search**
USPC D14/300–302, 313, 314, 341, 348–370,
D14/383, 385, 432, 436, 496, 125, 135,
D14/134, 155, 167, 168, 230, 231, 233,
D14/235, 237, 240–242, 299; D10/65,
D10/75, 78; D13/103, 149, 162, 184,
D13/199; D18/4.4–4.6, 12.1, 56;
361/679.31–679.45, 752; 711/100, 115;
382/115, 124; 356/71; 235/380, 461,
235/382, 472.01, 472.02; D3/201, 273
CPC G06K 9/00006; G06K 7/0013; G06K
9/00026; G06F 21/00; G06Q 30/00
See application file for complete search history.

(56) **References Cited**

U.S. PATENT DOCUMENTS

D429,725 S * 8/2000 Morimiya D14/384
D466,119 S * 11/2002 Funahashi D14/384
D514,105 S * 1/2006 Ohta D14/384
D516,069 S * 2/2006 Kuroda D14/384

D522,510 S * 6/2006 Su D14/384
D593,559 S * 6/2009 Lin D14/384
D786,355 S * 5/2017 Hendrick D19/9
D788,847 S * 6/2017 Hendrick D19/9
D825,562 S * 8/2018 Segal D14/384
D883,981 S * 5/2020 Zhan D14/384
D890,177 S * 7/2020 Mikami D14/384
D890,753 S * 7/2020 Iasso D14/384

* cited by examiner

Primary Examiner — Austin Murphy

(74) *Attorney, Agent, or Firm* — Hoffmann and Baron, LLP

(57) **CLAIM**

The ornamental design for a security device, as shown and described.

DESCRIPTION

FIG. 1 is a top perspective view of a security device constructed in accordance with the invention;
FIG. 2 is a bottom perspective view of the security device shown in FIG. 1;
FIG. 3 is a front view of the security device shown in FIG. 1;
FIG. 4 is a right side view of the security device as shown in FIG. 1;
FIG. 5 is a rear view of the security device shown in FIG. 1;
FIG. 6 is a left side view of the security device shown in FIG. 1;
FIG. 7 is a top elevational view of the security device shown in FIG. 1; and,
FIG. 8 is a bottom elevational view of the security device shown in FIG. 1.
The broken lines shown in the drawings represent unclaimed environment and are for illustrative purposes only, forming no part of the claimed design.

1 Claim, 6 Drawing Sheets

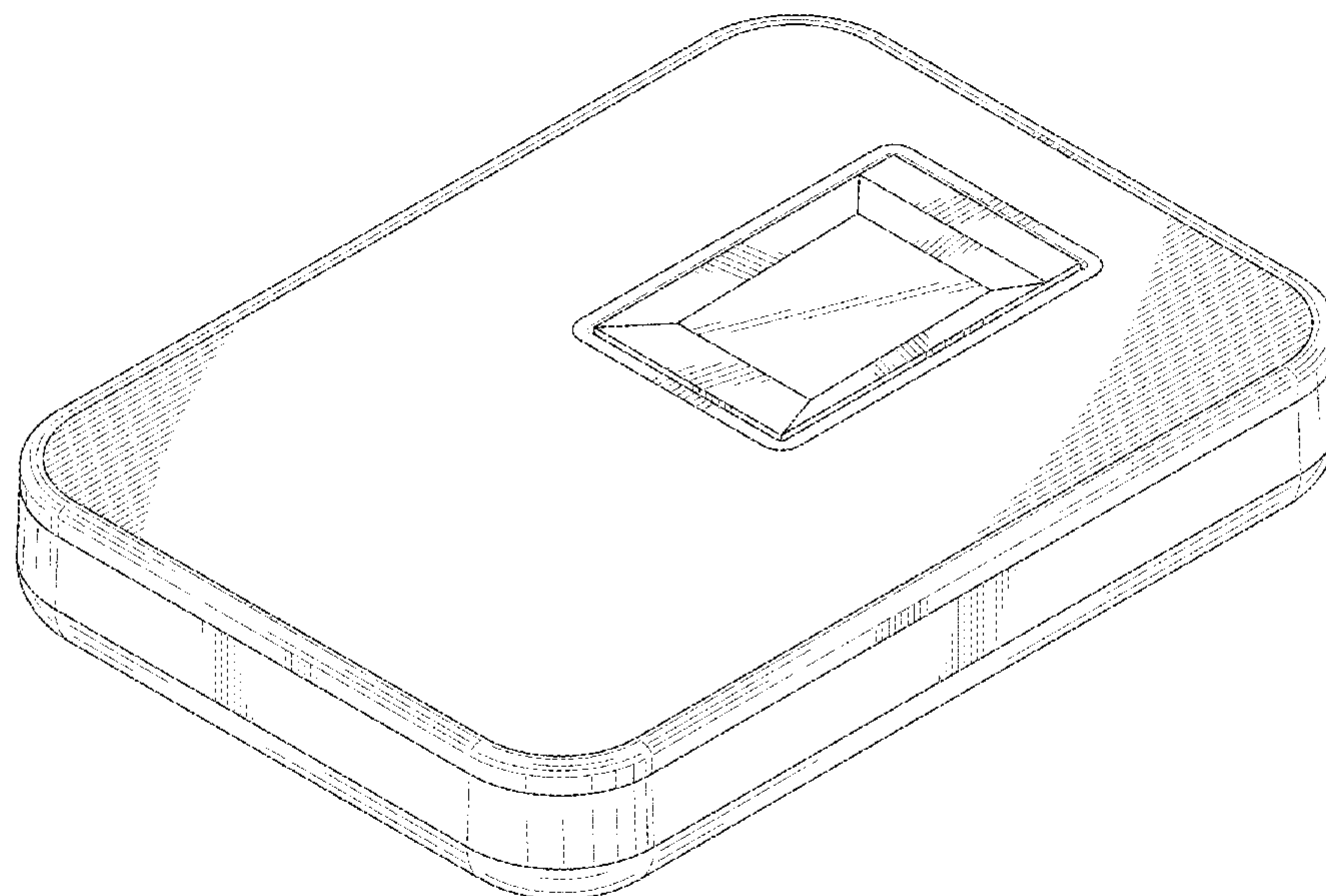

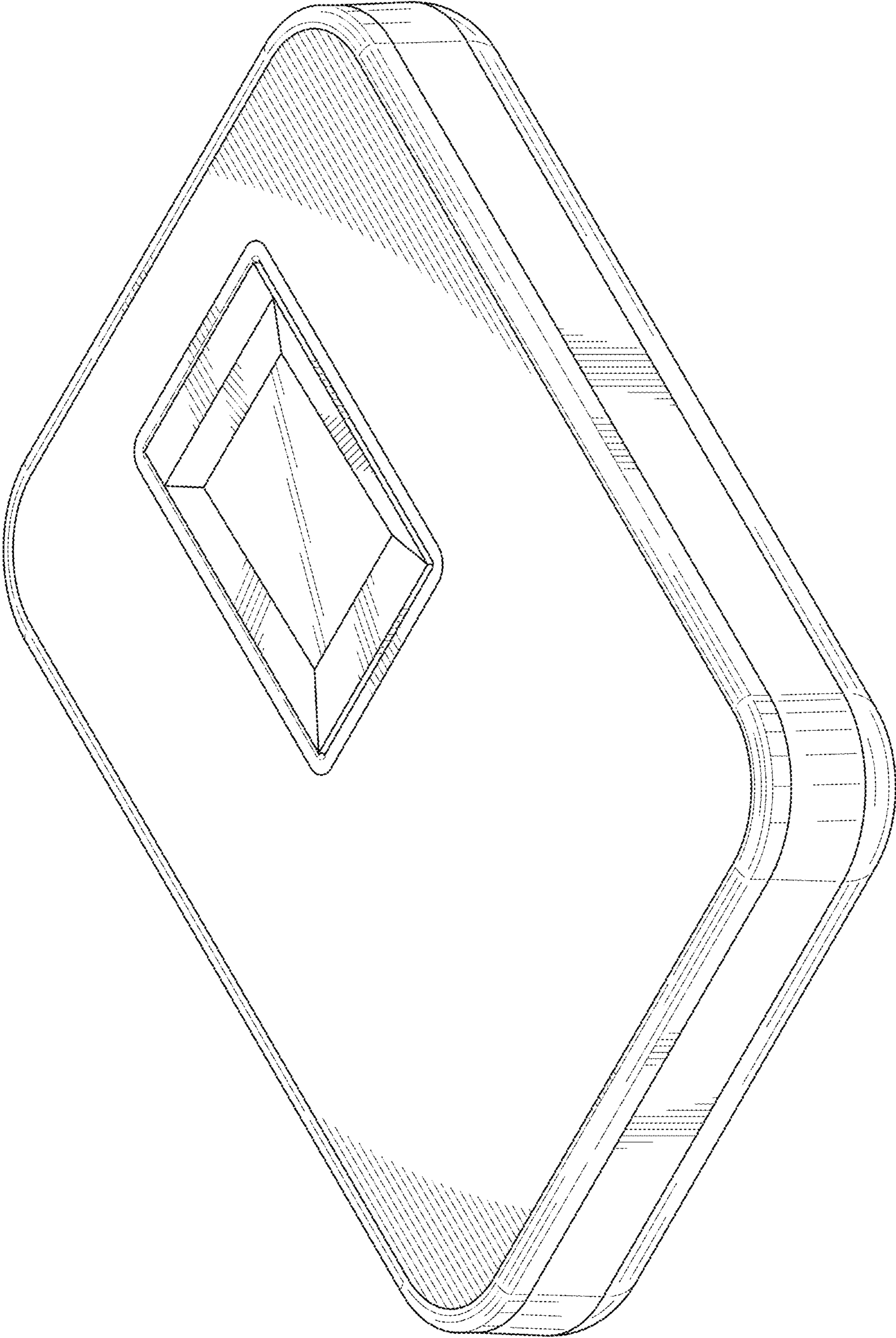

FIG. 1

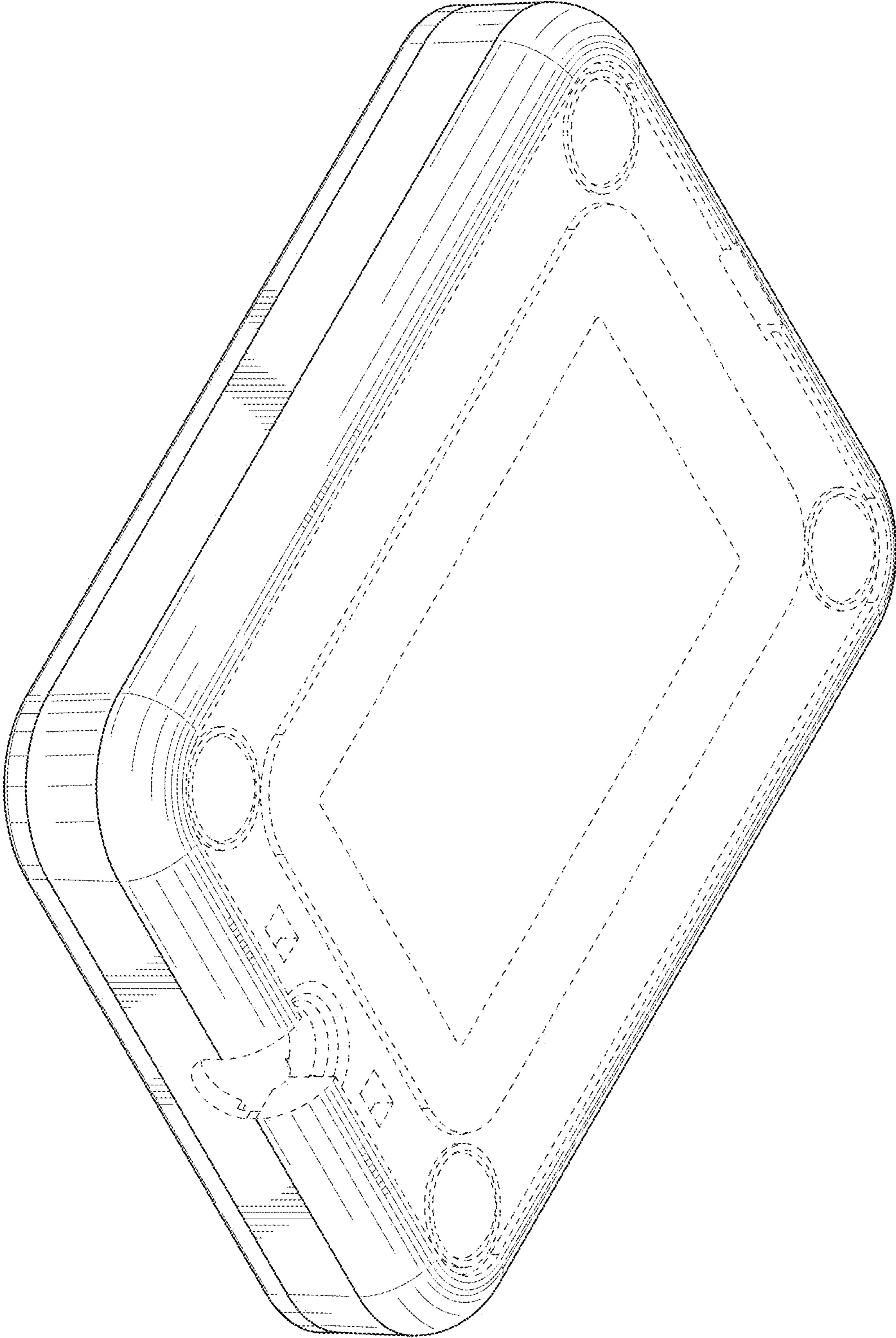

FIG. 2

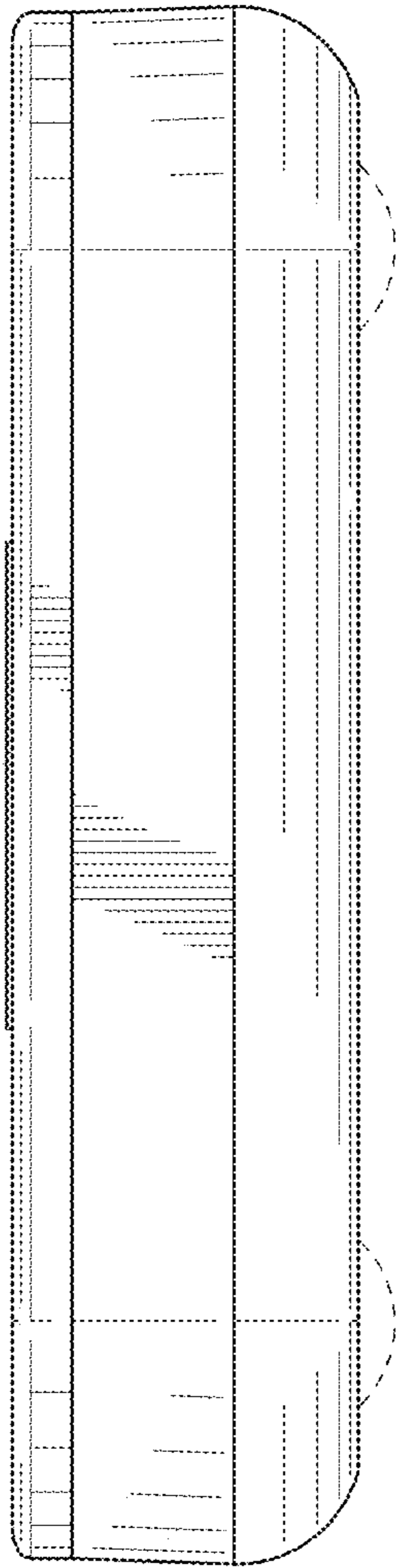

FIG. 3

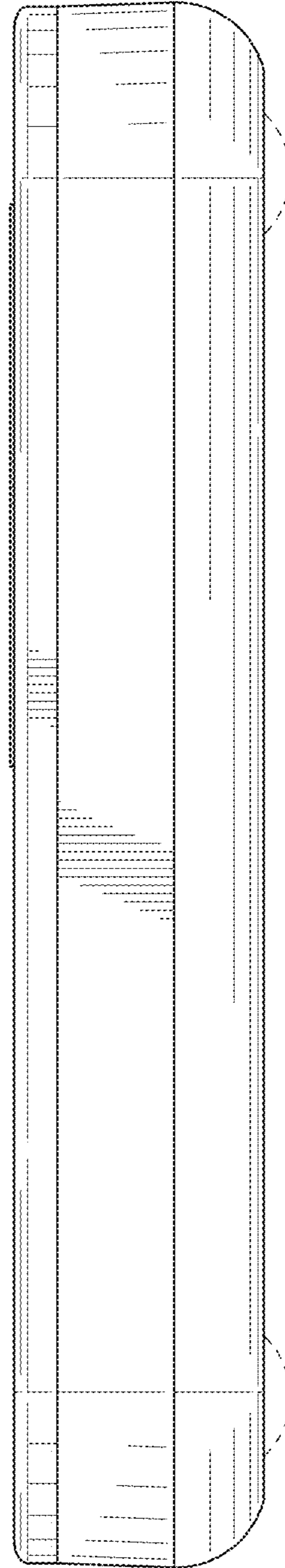

FIG. 4

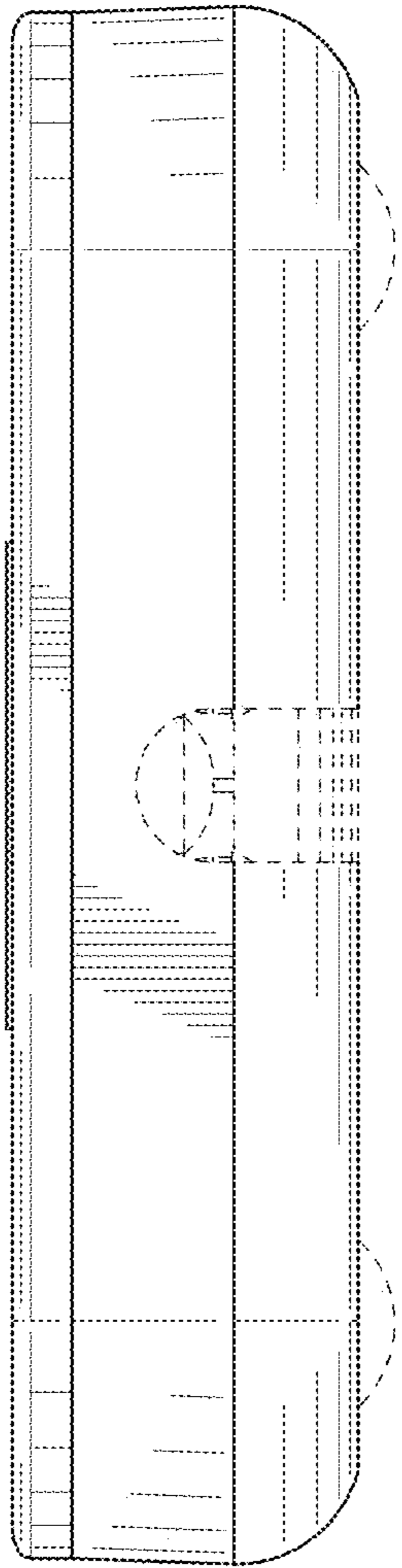

FIG. 5

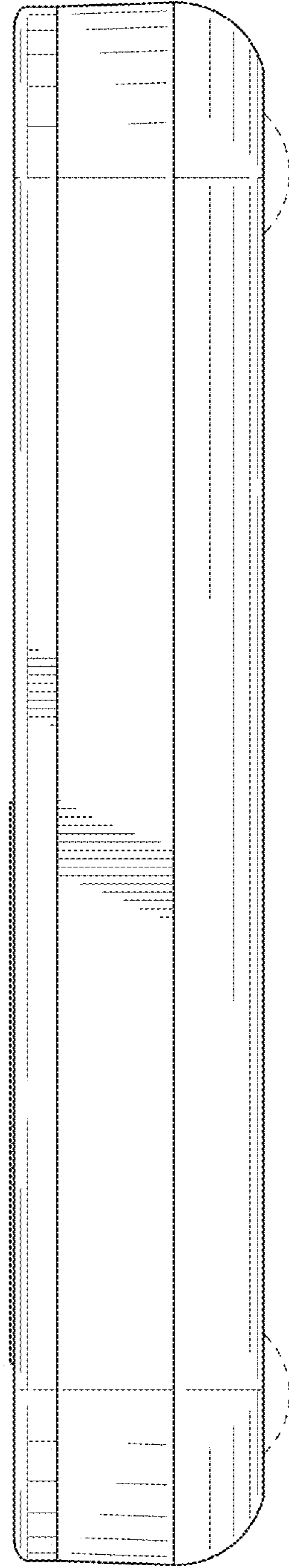

FIG. 6

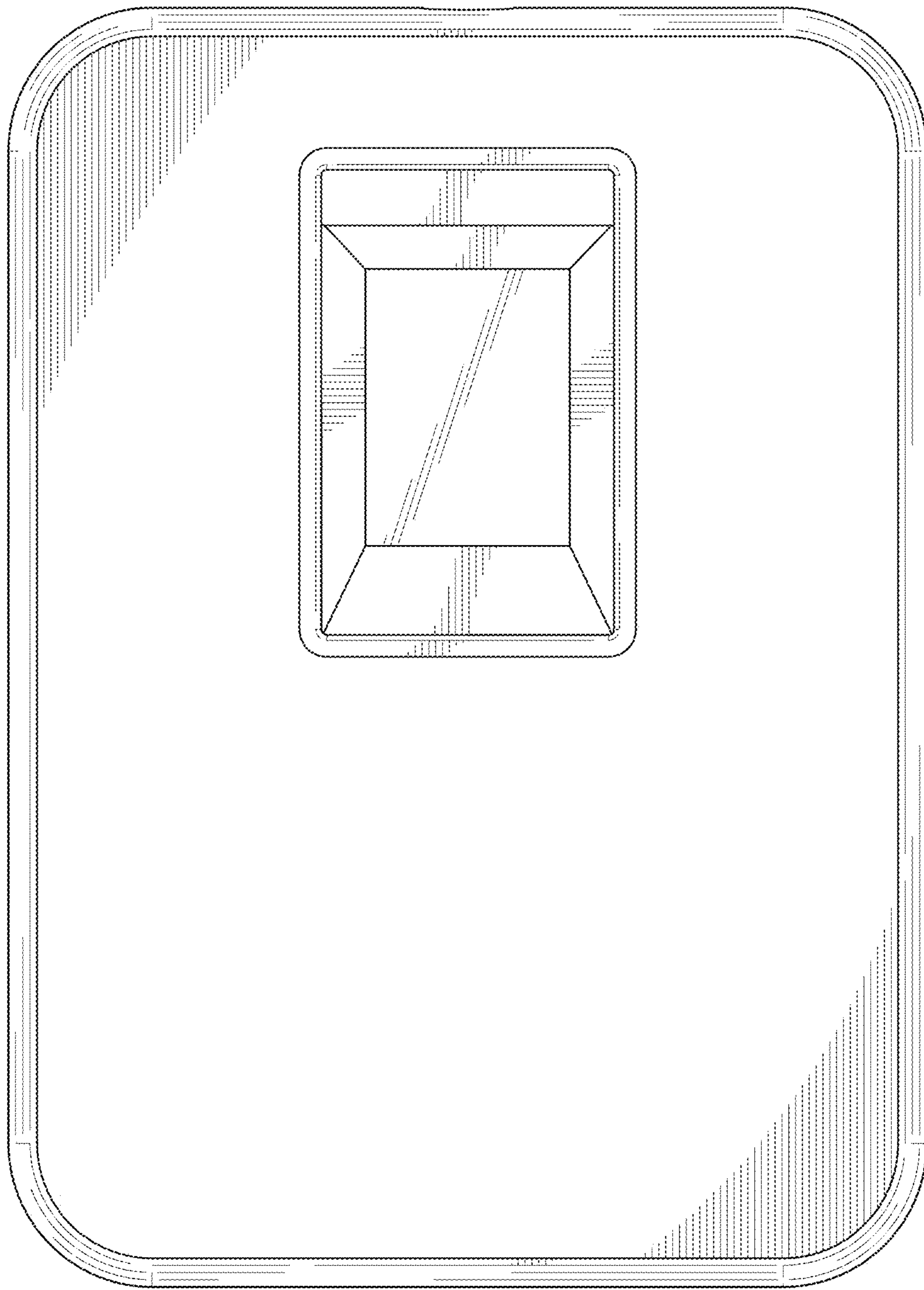

FIG. 7

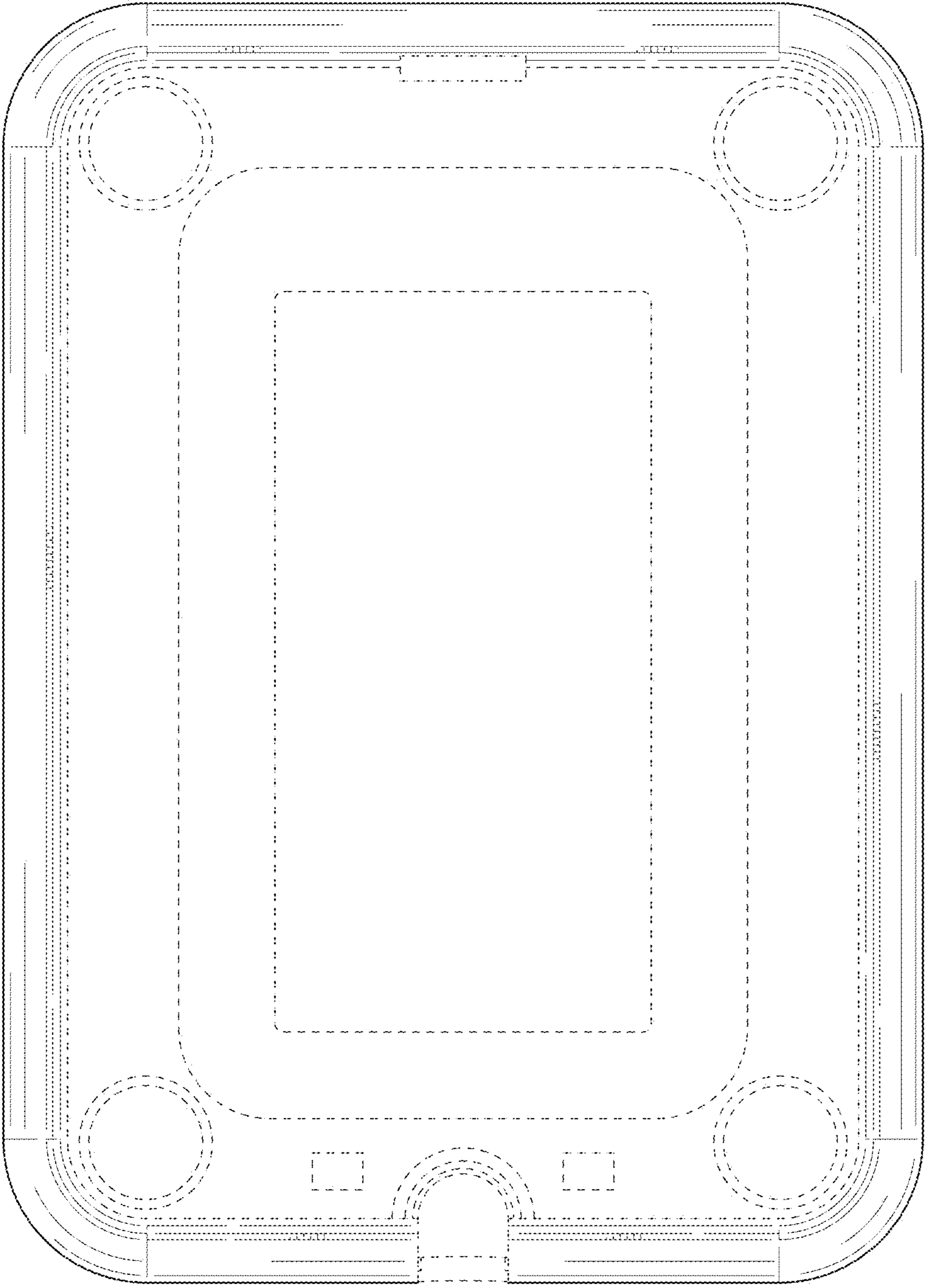

FIG. 8