

US00D948501S

(12) **United States Design Patent** (10) **Patent No.:** **US D948,501 S**
Lin et al. (45) **Date of Patent:** **** Apr. 12, 2022**

(54) **NOTEBOOK COMPUTER**

(71) Applicant: **Acer Incorporated**, New Taipei (TW)

(72) Inventors: **Cheng-Han Lin**, New Taipei (TW);
Pao-Ching Huang, New Taipei (TW)

(73) Assignee: **Acer Incorporated**, New Taipei (TW)

(**) Term: **15 Years**

(21) Appl. No.: **29/674,661**

(22) Filed: **Dec. 22, 2018**

(30) **Foreign Application Priority Data**

Aug. 3, 2018 (TW) 107304519

(51) **LOC (13) Cl.** **14-02**

(52) **U.S. Cl.**
USPC **D14/327**; D14/444

(58) **Field of Classification Search**
USPC D14/315–328, 432, 444–447; D18/1, 4.3,
D18/7, 12.2–12.3

CPC G06F 1/16; G06F 1/1601; G06F 1/1605;
G06F 1/165; G06F 1/166; G06F 1/1613;
G06F 1/1616; G06F 1/1618; G06F 1/162;
G06F 1/1622; G06F 1/1624; G06F
1/1633; G06F 1/1637; G06F 1/1615;
G06F 1/1643; G06F 1/1647; G06F
1/1649; G06F 1/1652; G06F 1/1654;
G06F 1/1656; G06F 1/1662; G06F
1/1669; G06F 1/1671; G06F 1/1688;
G06F 1/1692; G06F 1/181; G06F 1/20;

(Continued)

(56) **References Cited**

U.S. PATENT DOCUMENTS

D786,258 S * 5/2017 Ignomirello D14/445
D822,029 S * 7/2018 Crisp D14/445
D879,790 S * 3/2020 Donachy D14/444

(Continued)

OTHER PUBLICATIONS

Etienne, Stefan, The Best Gaming Laptops You Can Buy Right Now, posted at The Verge, posting date Jul. 13, 2018. Site visited Nov. 30, 2021. URL: <<https://www.theverge.com/this-is-my-next/2018/7/13/17550032/best-gaming-laptop-computer>> (Year: 2018).*

(Continued)

Primary Examiner — Kathleen L Jones

(74) *Attorney, Agent, or Firm* — JCIPRNET

(57) **CLAIM**

The ornamental design for a notebook computer, as shown and described.

DESCRIPTION

FIG. 1 is a perspective view of a notebook computer showing our new design;

FIG. 2 is another perspective view thereof;

FIG. 3 is a front view thereof;

FIG. 4 is a rear view thereof;

FIG. 5 is a left side view thereof;

FIG. 6 is a right side view thereof;

FIG. 7 is a top view thereof;

FIG. 8 is a bottom view thereof;

FIG. 9 is an enlarged view of an indicated portion of FIG. 1;

FIG. 10 is an enlarged view of an indicated portion of FIG. 2;

FIG. 11 is an enlarged view of an indicated portion of FIG. 3; and,

FIG. 12 is an enlarged view of an indicated portion of FIG. 6.

The dashed broken lines illustrate portions of the notebook computer and form no part of the claimed design. The dot-dash broken lines define the bounds of the claimed design and form no part thereof. The dot dot dash broken lines indicate portions of the figures shown enlarged and form no part of the claimed design.

1 Claim, 10 Drawing Sheets

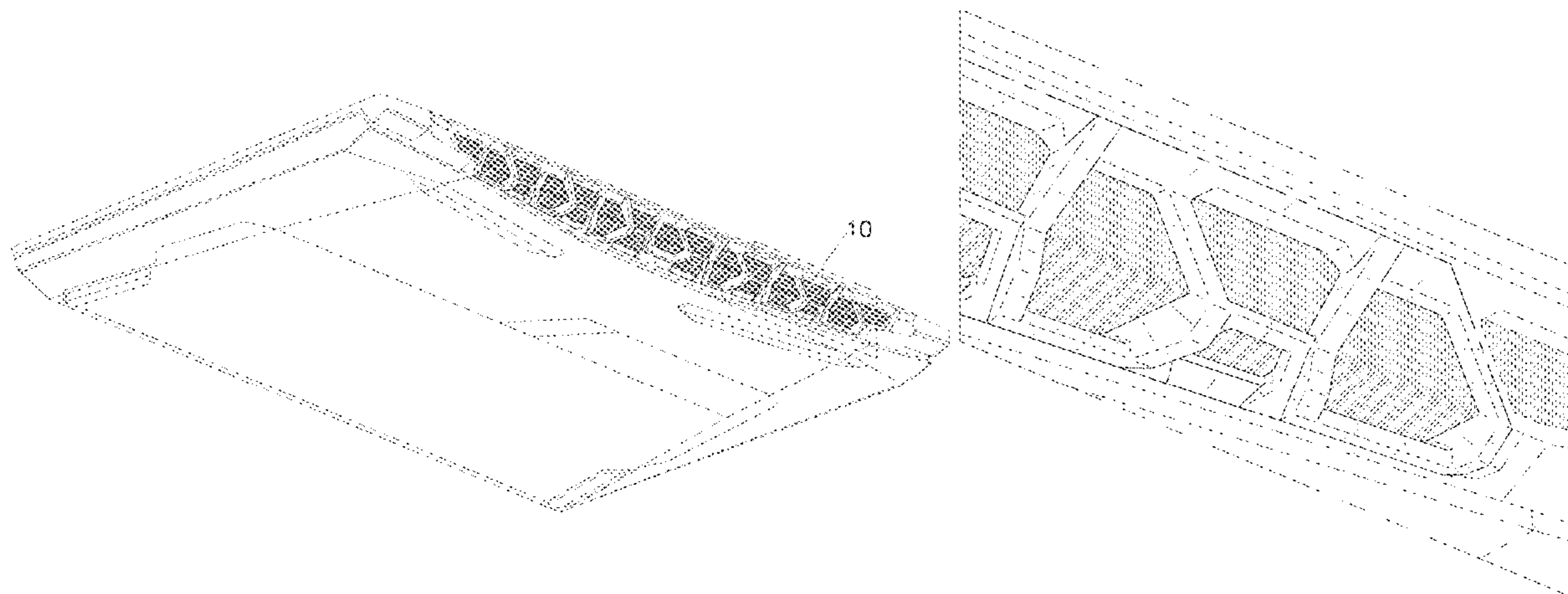

(58) **Field of Classification Search**

CPC ... G06F 1/203; G06F 15/0216; H05K 5/0047;
H05K 5/0052

See application file for complete search history.

(56) **References Cited**

U.S. PATENT DOCUMENTS

D881,873	S	*	4/2020	Li	D14/316
D897,337	S	*	9/2020	Probst	D14/324
D917,457	S	*	4/2021	Liu	D14/315
D917,459	S	*	4/2021	Chung	D14/315
D919,615	S	*	5/2021	Probst	D14/324
D931,273	S	*	9/2021	Wang	D14/315
D936,646	S	*	11/2021	Lin	D14/327
2005/0243510	A1	*	11/2005	Tomioka	G06F 1/203 361/679.52
2016/0013745	A1	*	1/2016	North	G06F 1/1684 318/460

OTHER PUBLICATIONS

Cooper, D., Acer updates its gaming laptops with new Intel chips, posted at Engadget, posting date Jun. 23, 2020. Site visited Nov. 30, 2021. URL: <<https://www.engadget.com/acer-predator-gaming-laptops-intel-10th-generation-134537935.html>> (Year: 2020).*

* cited by examiner

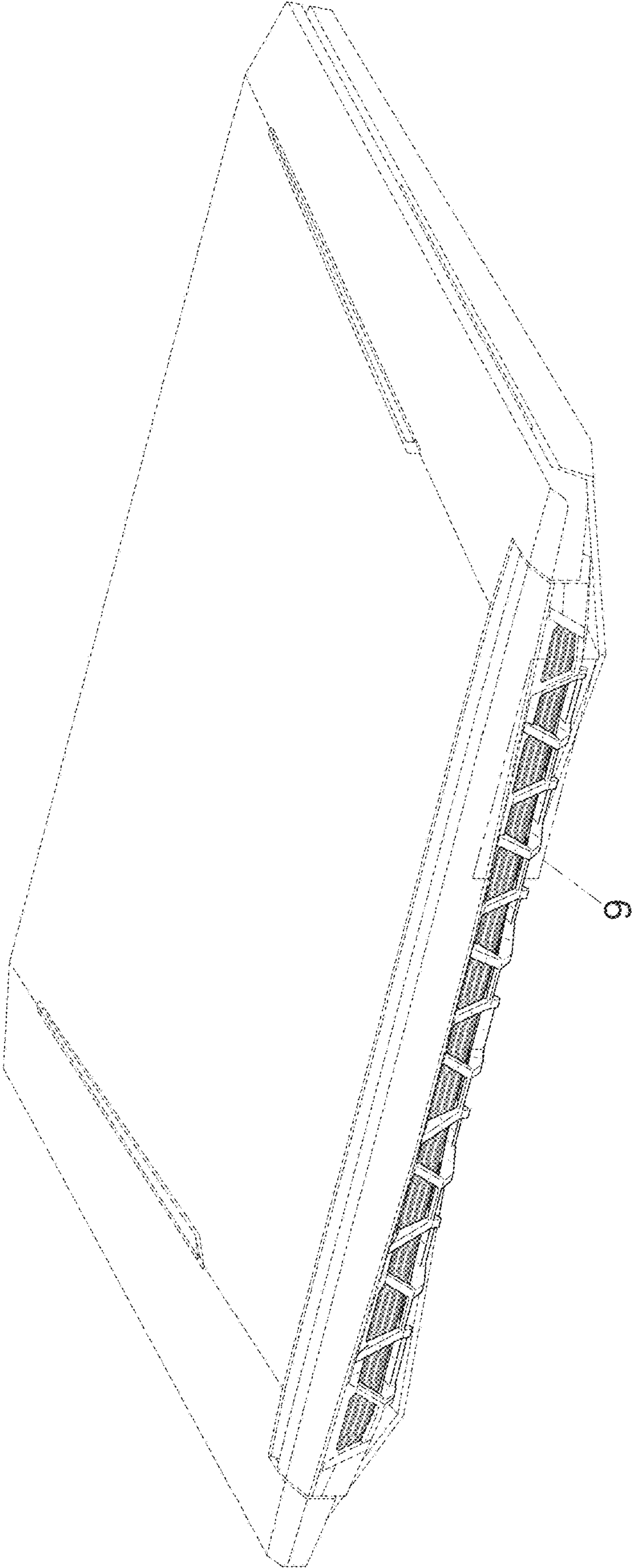

FIG. 1

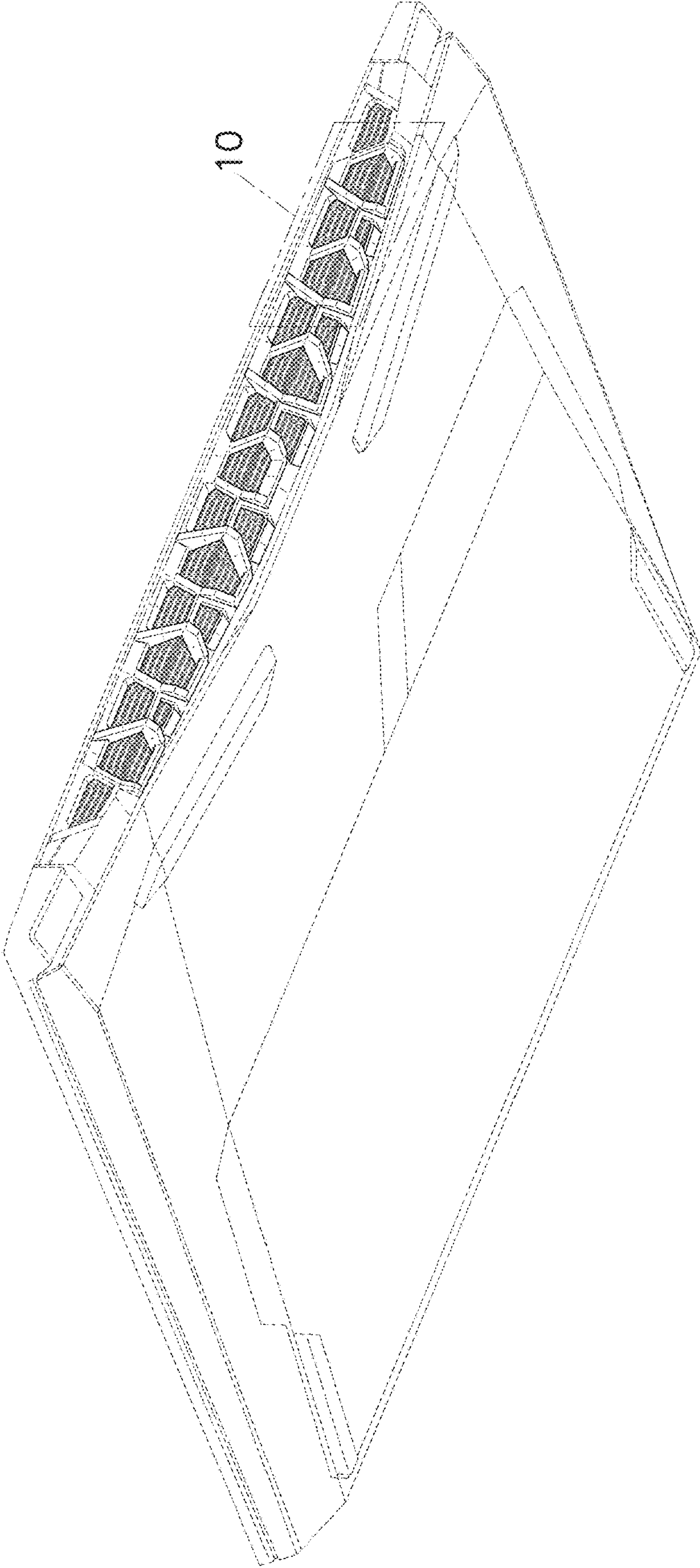

FIG. 2

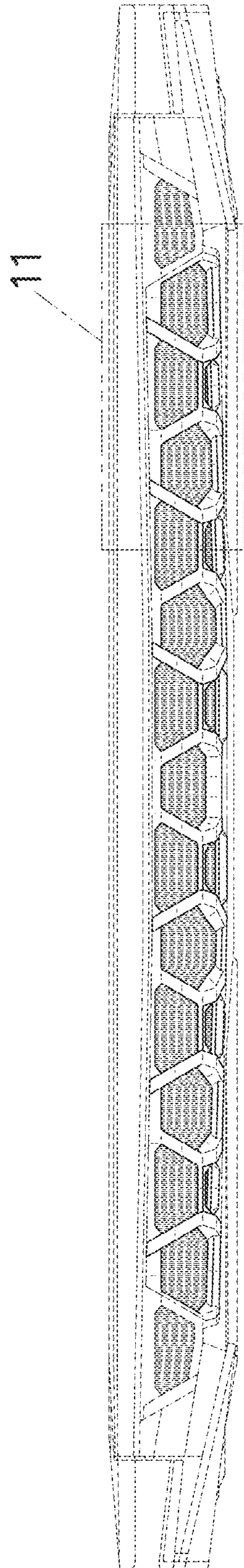

FIG. 3

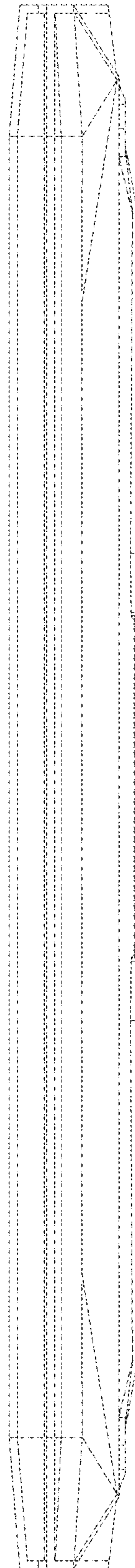

FIG. 4

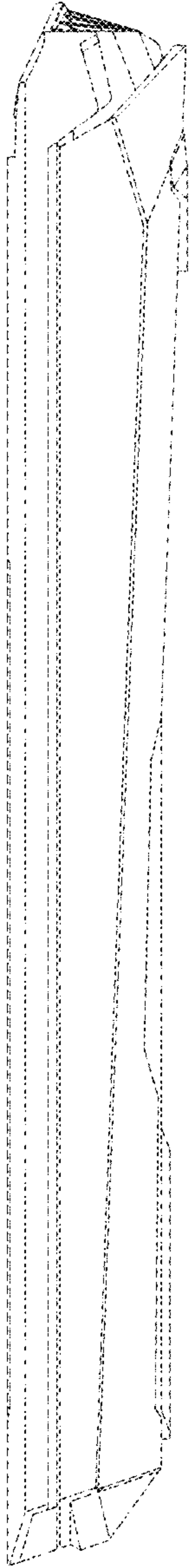

FIG. 5

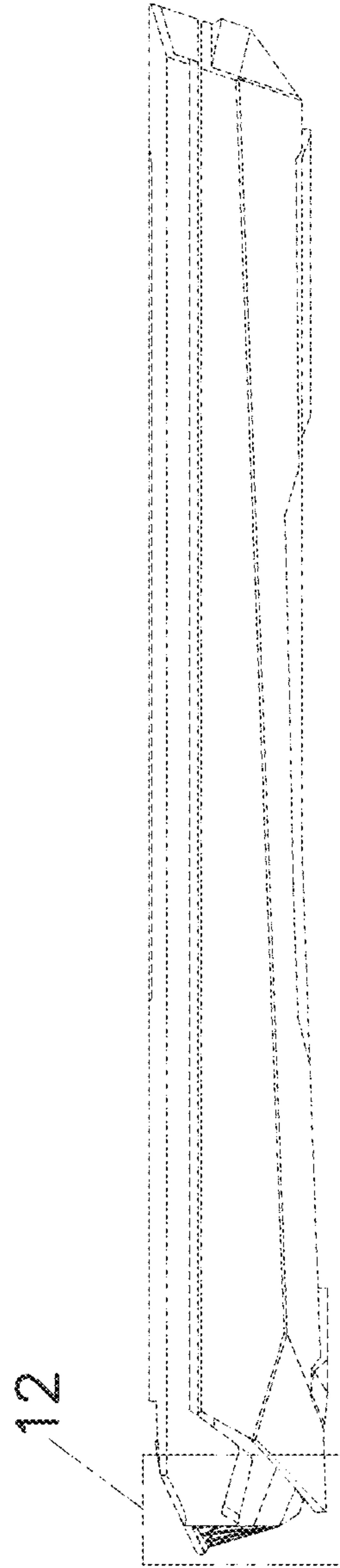

FIG. 6

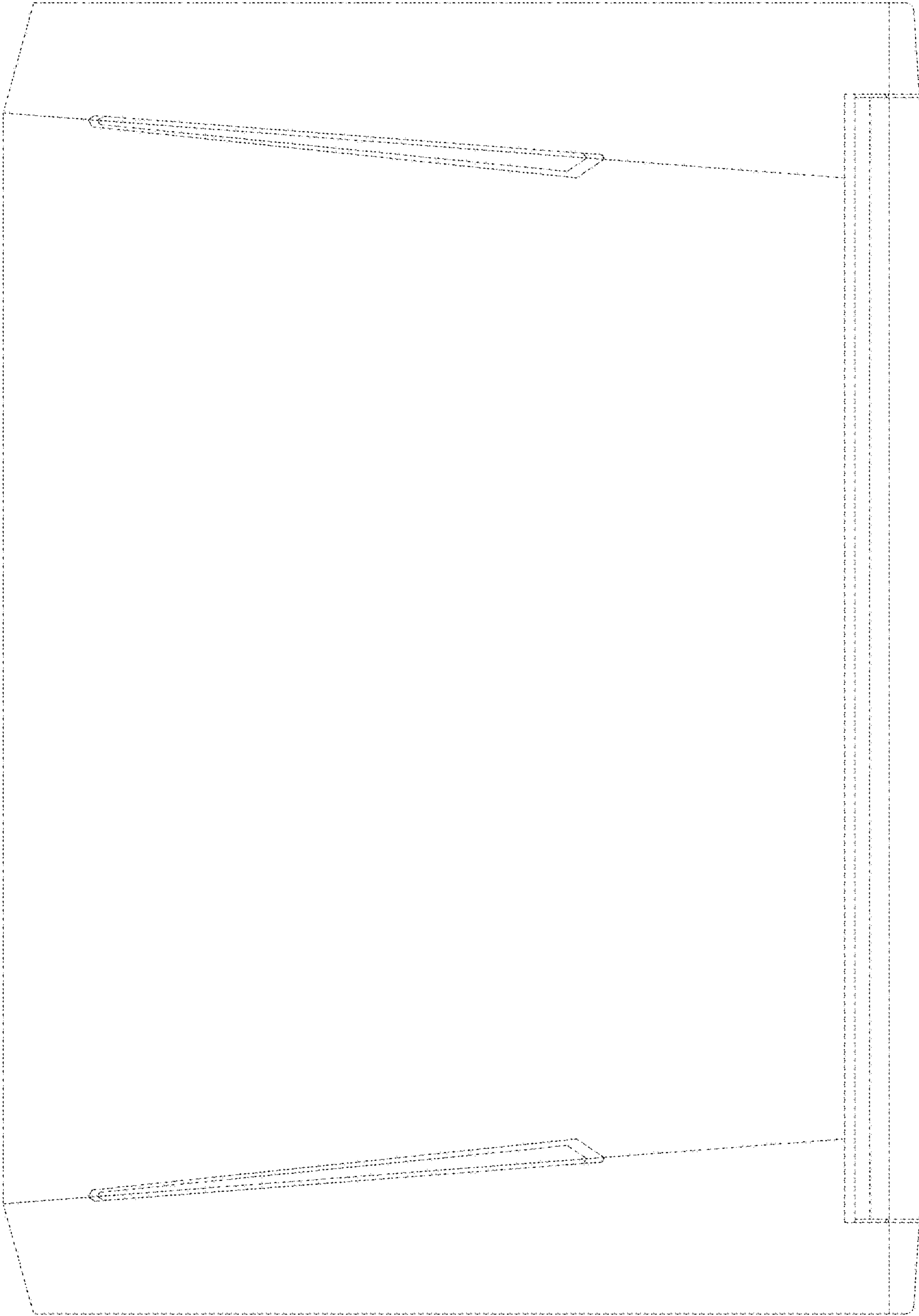

FIG. 7

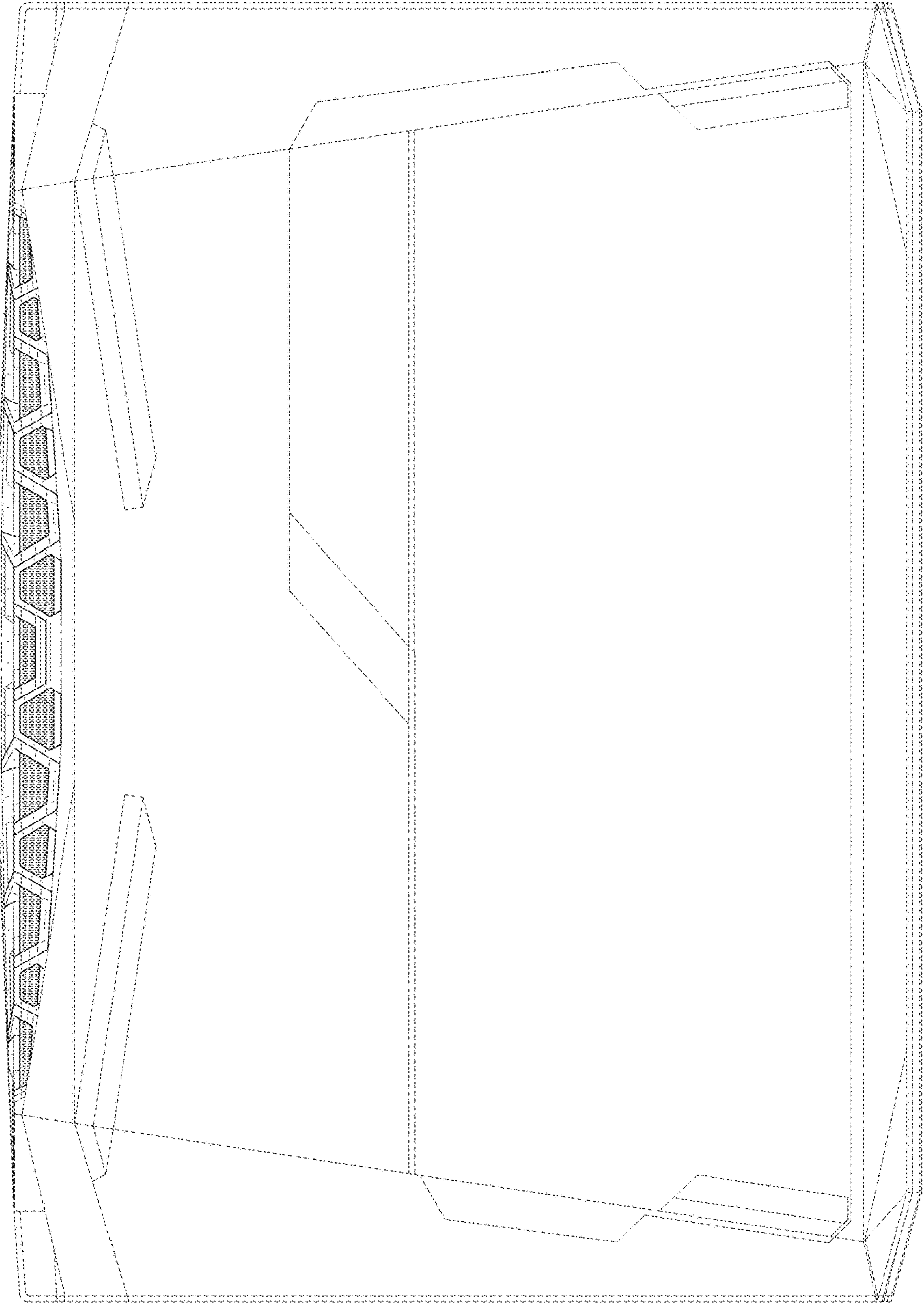

FIG. 8

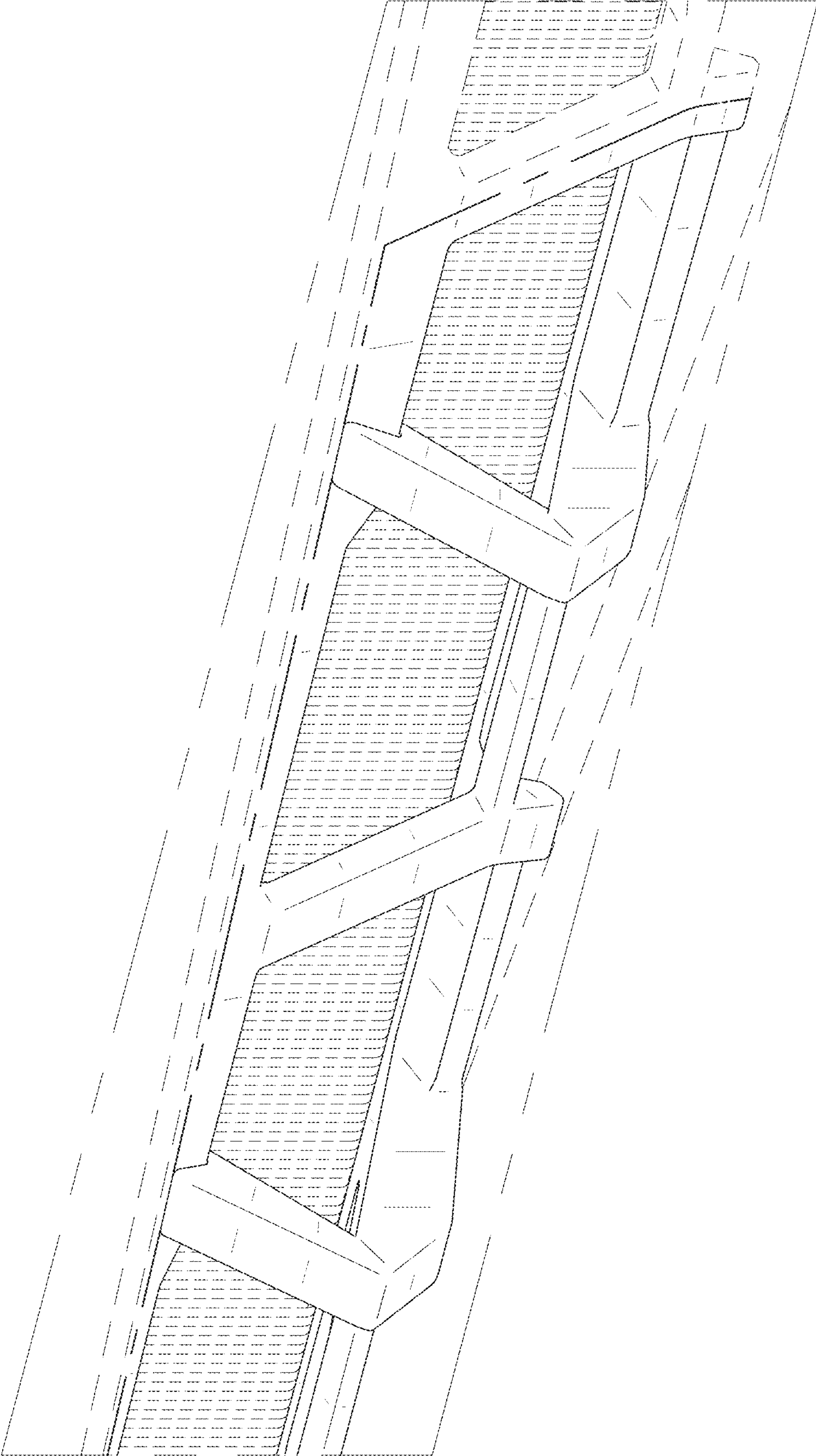

FIG. 9

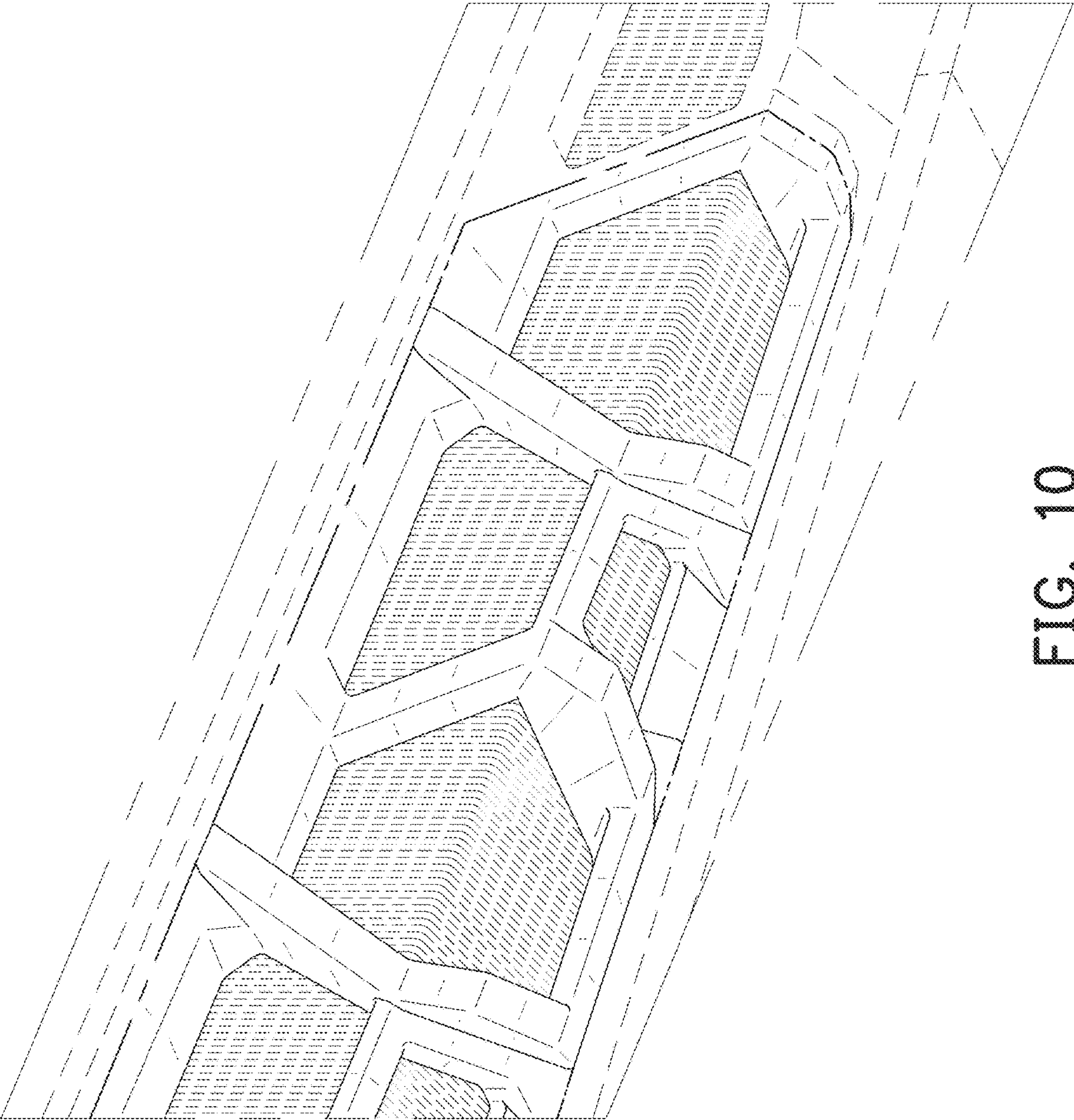

FIG. 10

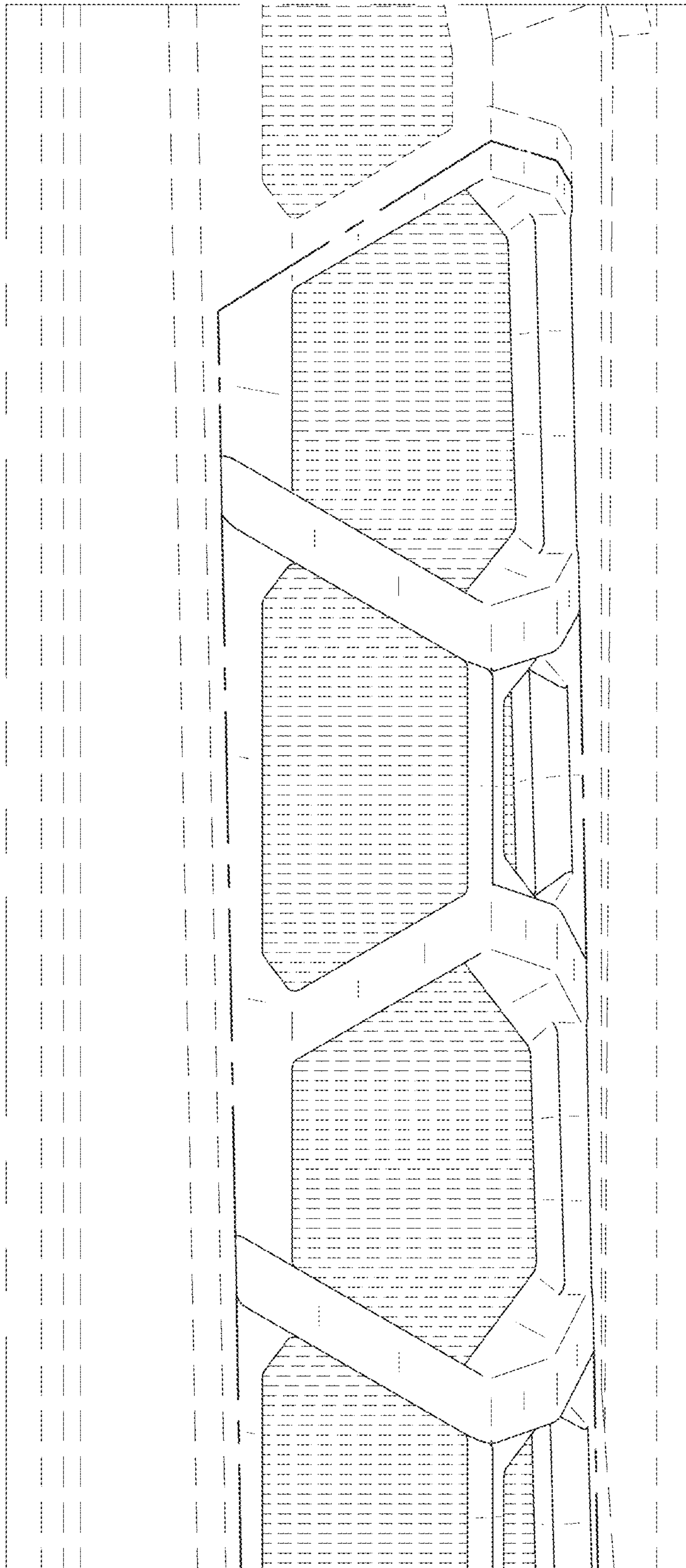

FIG. 11

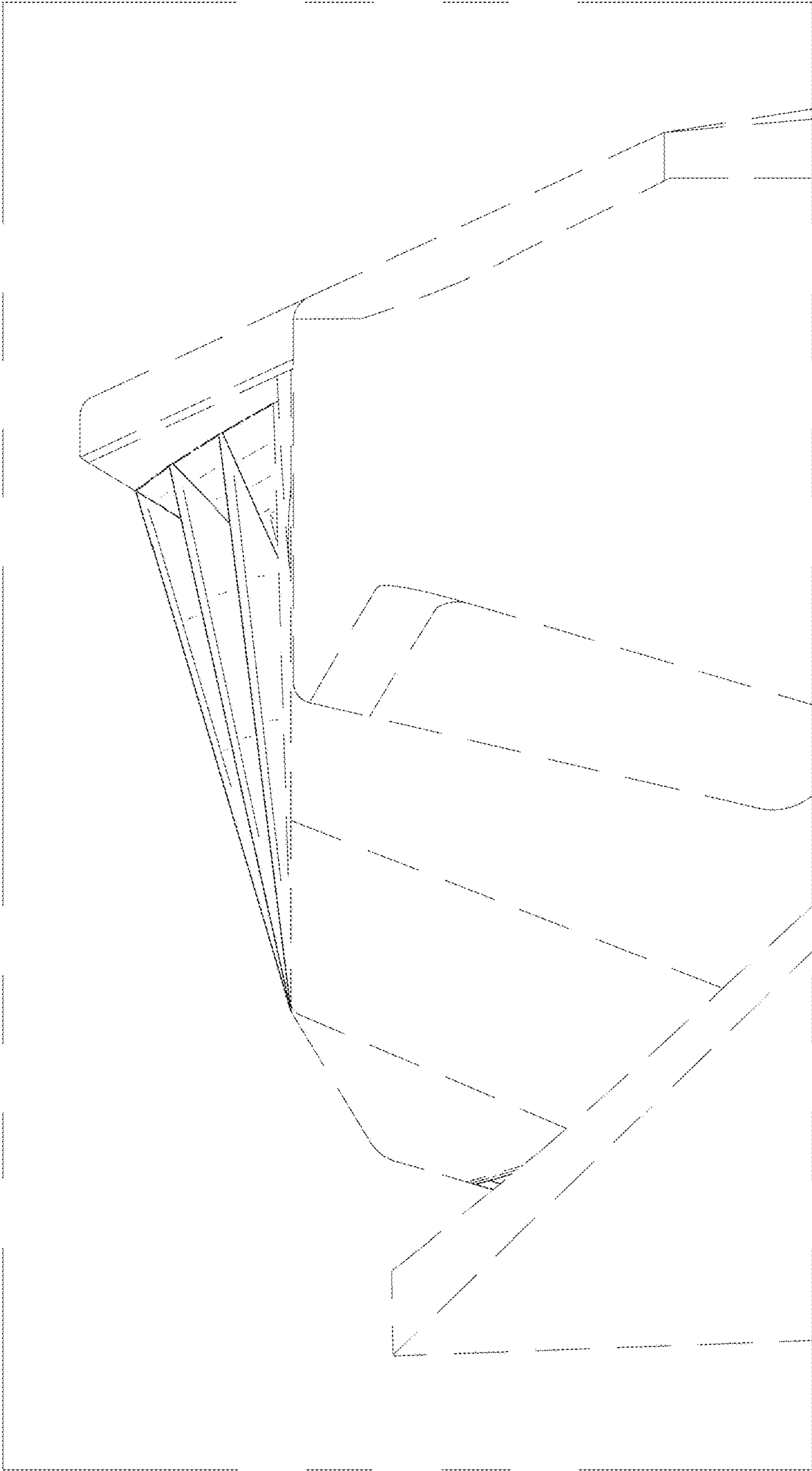

FIG. 12