



US00D948370S

(12) **United States Design Patent**  
**Wahlgren et al.**

(10) **Patent No.:** **US D948,370 S**

(45) **Date of Patent:** **\*\* \*Apr. 12, 2022**

(54) **SIREN**

(71) Applicant: **Axis AB**, Lund (SE)

(72) Inventors: **Theodor Wahlgren**, Lund (SE); **Felix Carlsson**, Lund (SE); **Jonas Sjögren**, Lund (SE); **Sebastian Engwall**, Lund (SE); **Mariano Vozzi**, Lund (SE); **Mathias Walter**, Lund (SE); **Oskar Odén**, Lund (SE)

(73) Assignee: **AXIS AB**, Lund (SE)

(\*) Notice: This patent is subject to a terminal disclaimer.

(\*\*) Term: **15 Years**

(21) Appl. No.: **29/740,784**

(22) Filed: **Jul. 7, 2020**

(30) **Foreign Application Priority Data**

Jan. 14, 2020 (EM) ..... 007509583

(51) **LOC (13) Cl.** ..... **10-06**

(52) **U.S. Cl.**  
USPC ..... **D10/120**

(58) **Field of Classification Search**  
USPC ..... D10/120, 104.1, 106.1, 106.5, 116.1;  
D16/203  
CPC ..... G10K 7/00; G08B 3/00  
See application file for complete search history.

(56) **References Cited**

**U.S. PATENT DOCUMENTS**

D225,379 S \* 12/1972 Gallagher et al. .... D10/106.5  
D249,481 S \* 9/1978 Conforti ..... D10/106.5  
D261,242 S \* 10/1981 Lorist ..... D10/106.1  
D476,252 S \* 6/2003 Runciman ..... D10/106.5

D577,301 S \* 9/2008 Johnson ..... D10/106.1  
D641,645 S \* 7/2011 Suzuki ..... D10/106.5  
D694,306 S \* 11/2013 Katori ..... D16/203  
D729,859 S \* 5/2015 Shin ..... D16/203  
D749,660 S \* 2/2016 Yu ..... D16/203  
D751,621 S \* 3/2016 Katori ..... D16/203  
D752,674 S \* 3/2016 Katori ..... D16/203  
D796,566 S \* 9/2017 Bingleman ..... D16/203  
D796,567 S \* 9/2017 Bingleman ..... D16/203  
10,223,885 B2 \* 3/2019 Larsson ..... H04N 5/332  
D866,636 S \* 11/2019 Walter ..... D16/203  
D879,635 S \* 3/2020 Højmosé ..... D10/104.1

**FOREIGN PATENT DOCUMENTS**

EM 001343578 9/2012  
EM 004529626 12/2017  
EM 006620860 7/2019

\* cited by examiner

*Primary Examiner* — George D. Kirschbaum

*Assistant Examiner* — Lillian Windham

(74) *Attorney, Agent, or Firm* — Tucker Ellis LLP

(57) **CLAIM**

The ornamental design for a siren, as shown and described.

**DESCRIPTION**

FIG. 1 is a front, top, right side perspective view of a first embodiment of a siren showing our new design;  
FIG. 2 is a front view thereof;  
FIG. 3 is a rear view thereof;  
FIG. 4 is a top view thereof;  
FIG. 5 is a bottom view thereof;  
FIG. 6 is a right side view thereof; and,  
FIG. 7 is a left side view thereof.  
The broken lines, and the subject matter disclosed inside the broken lines, illustrate portions of the siren that form no part of the claimed design.

**1 Claim, 5 Drawing Sheets**

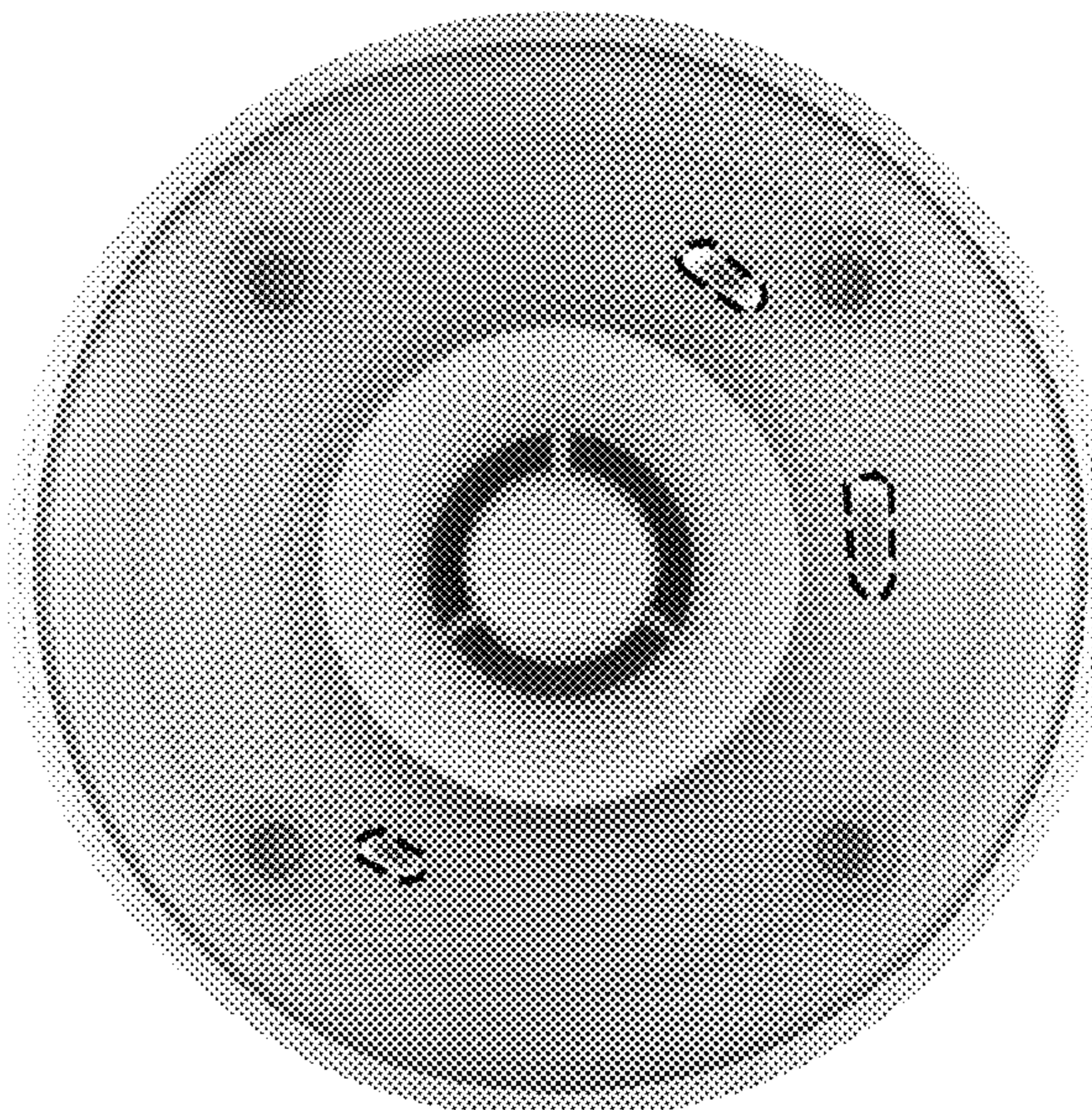
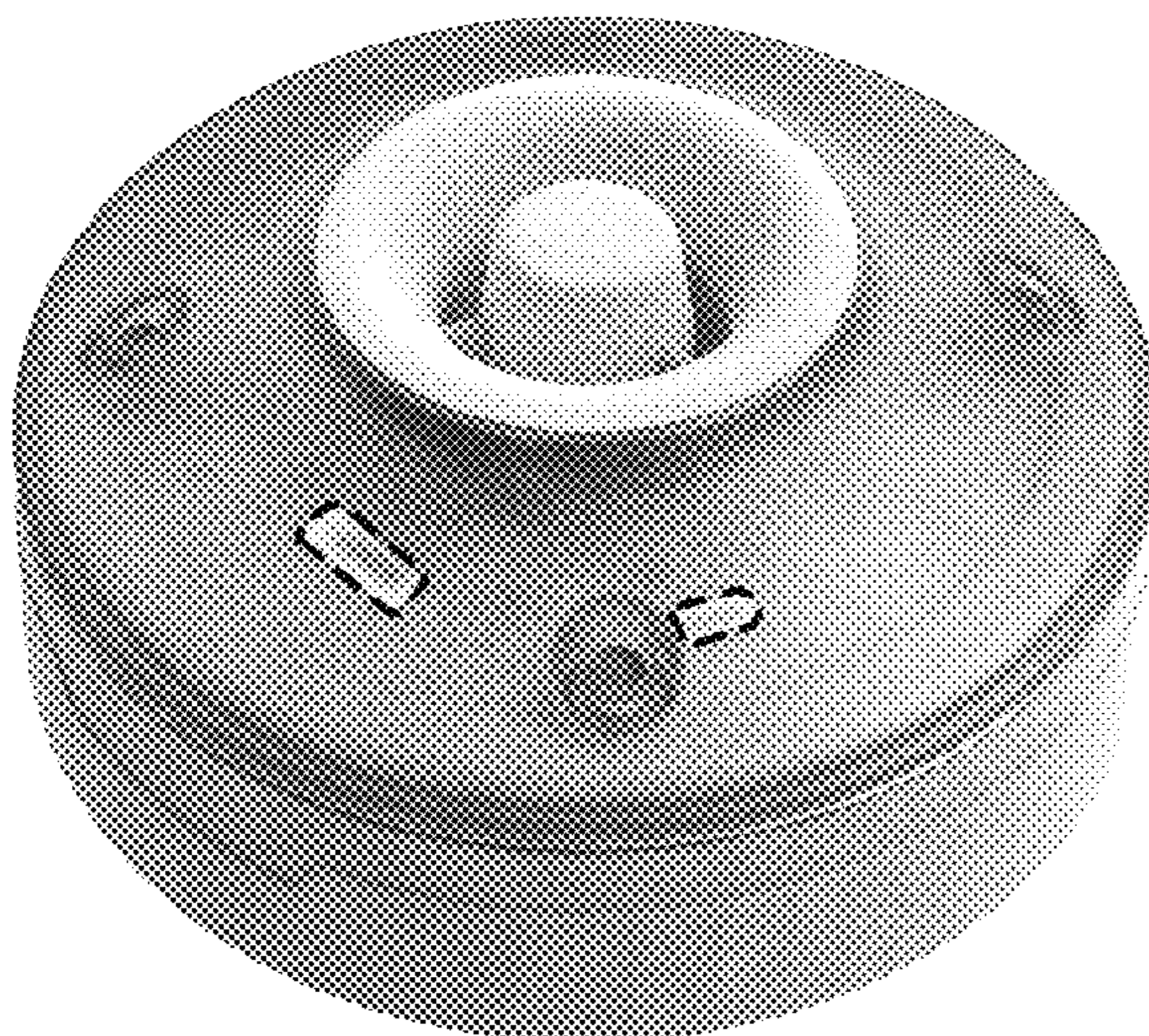





FIG. 1





FIG. 2



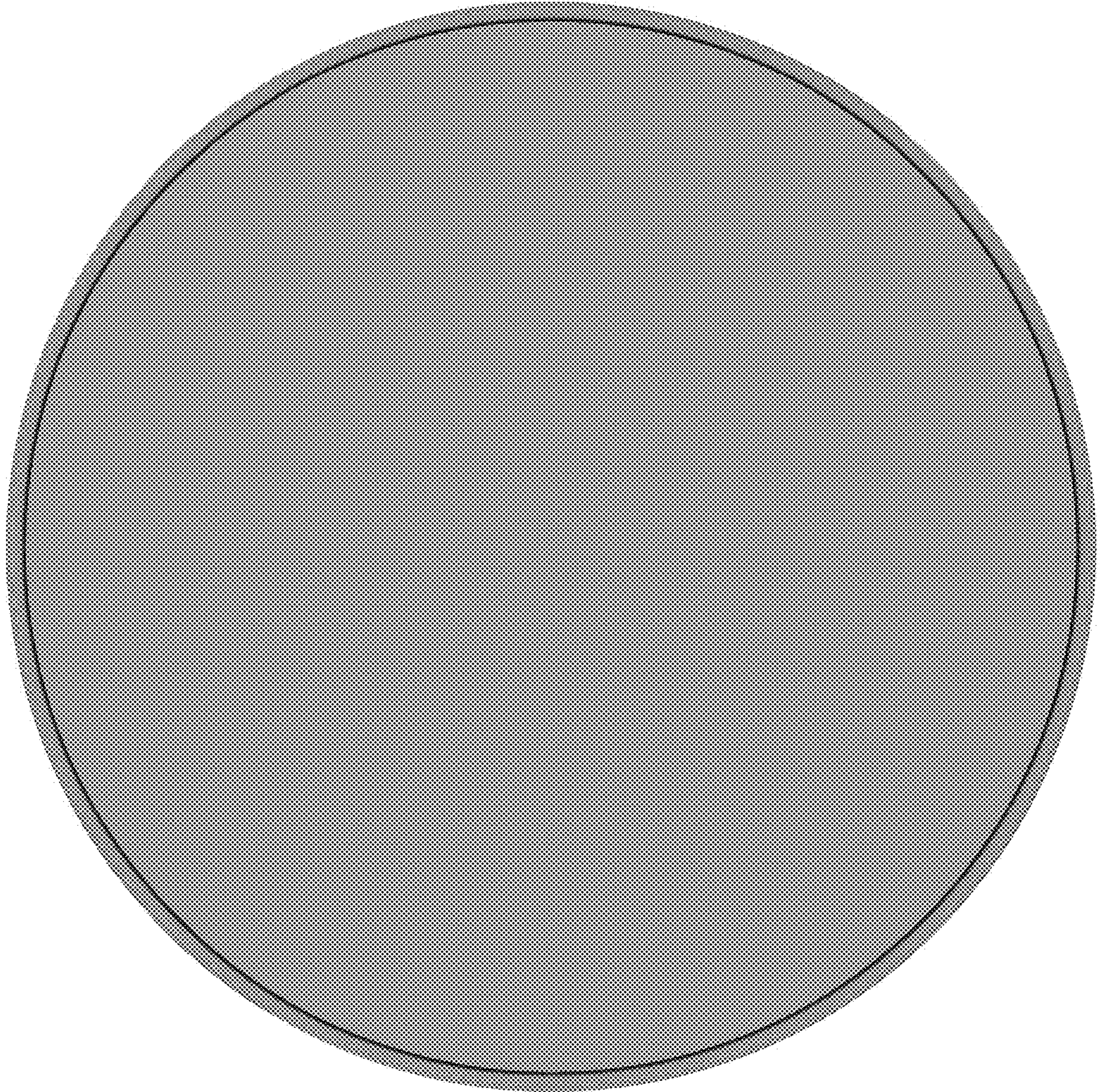

FIG. 3



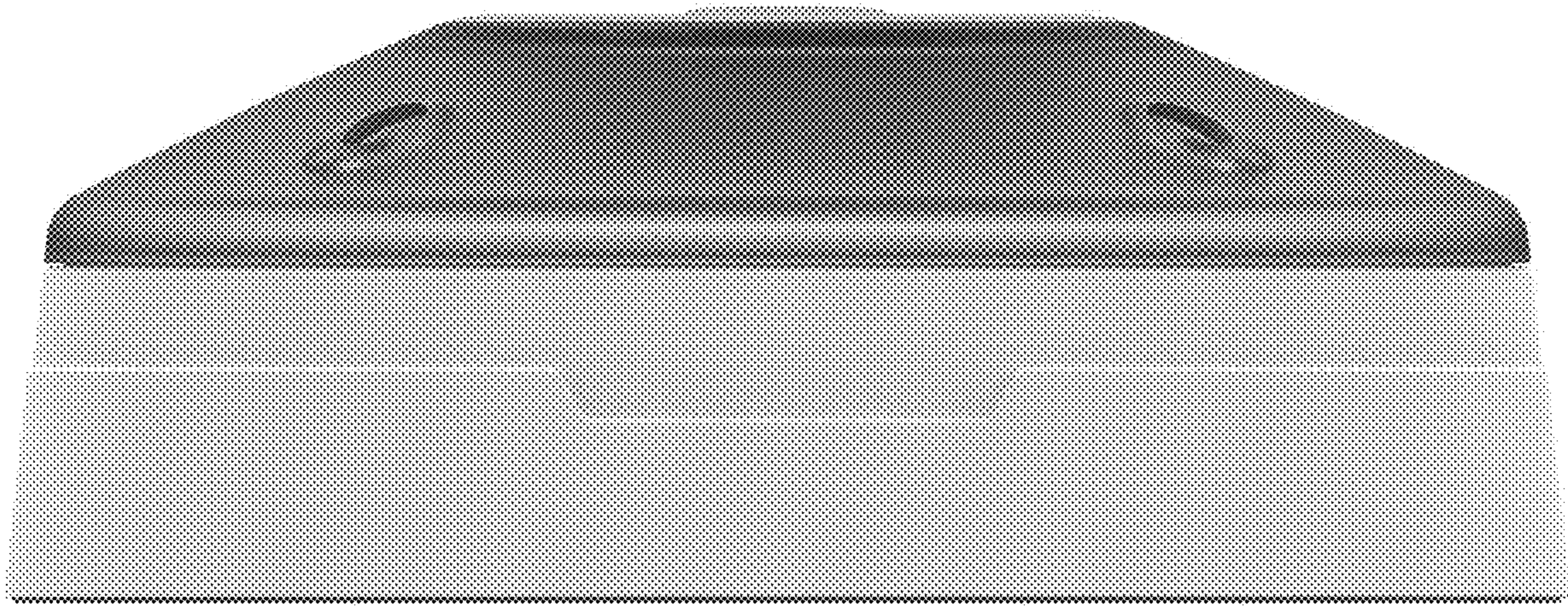

FIG. 4

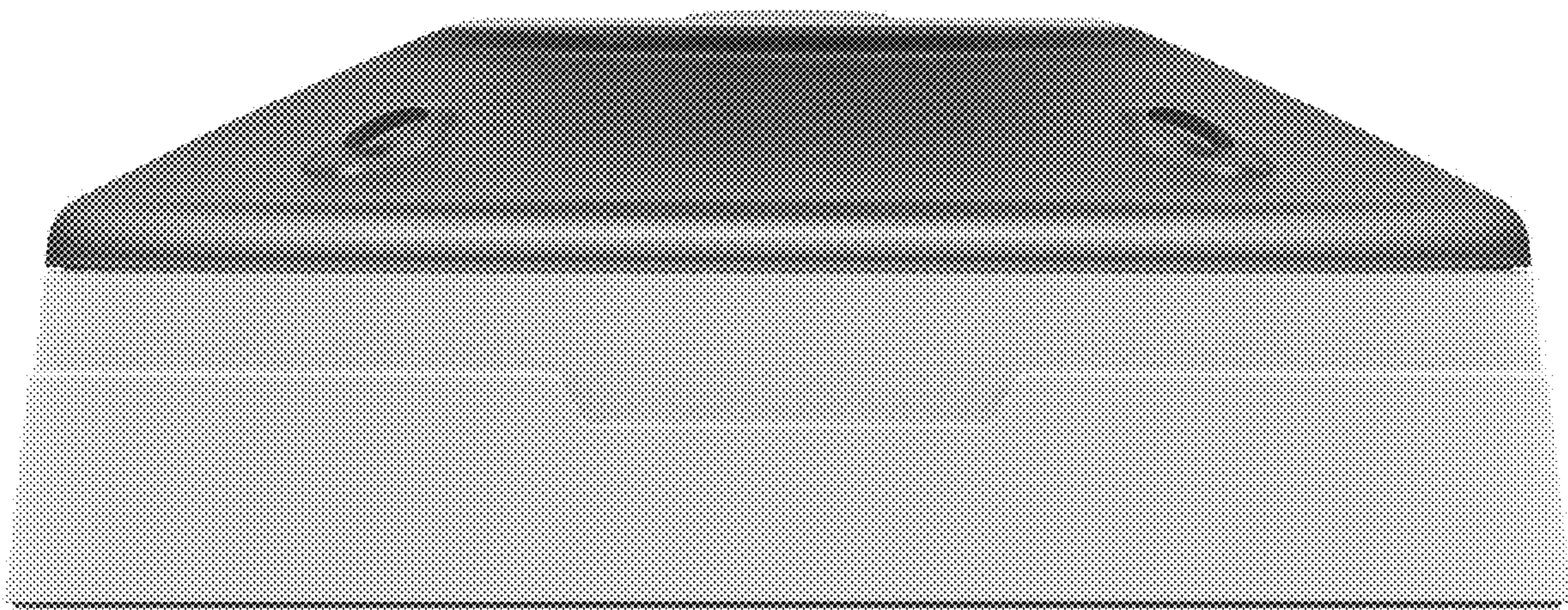

FIG. 5



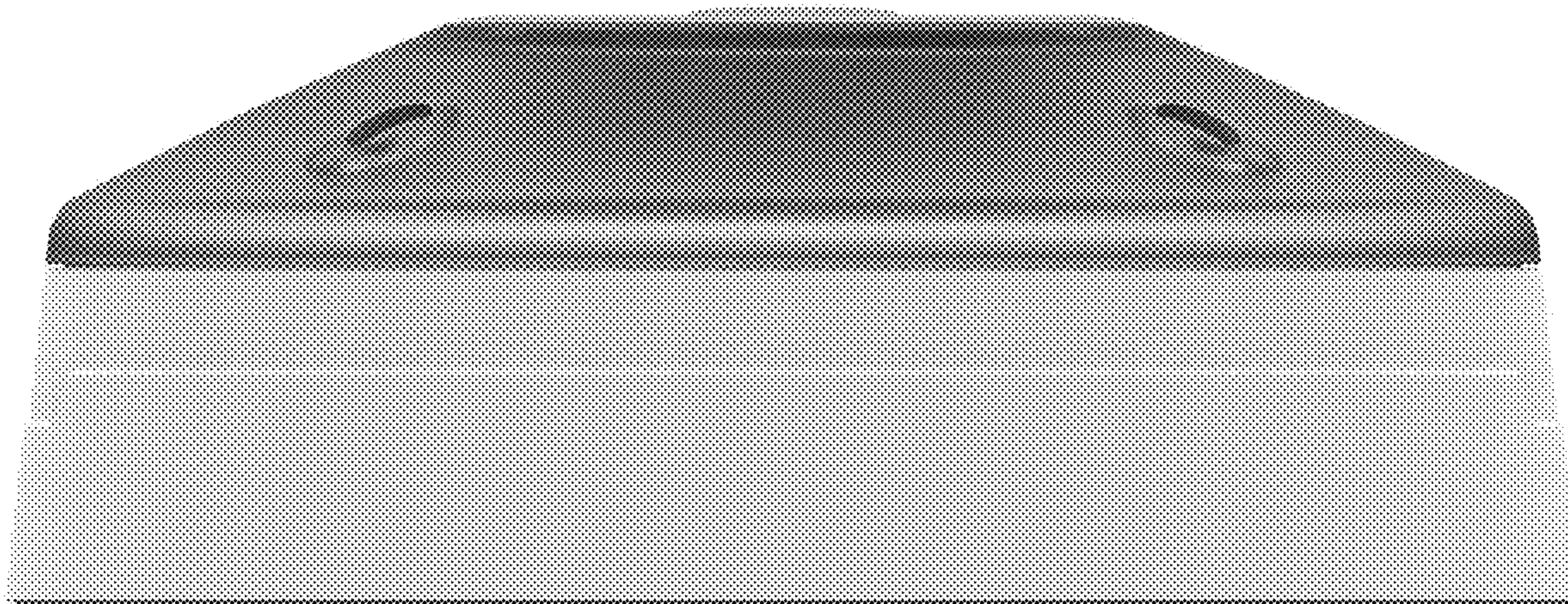

FIG. 6

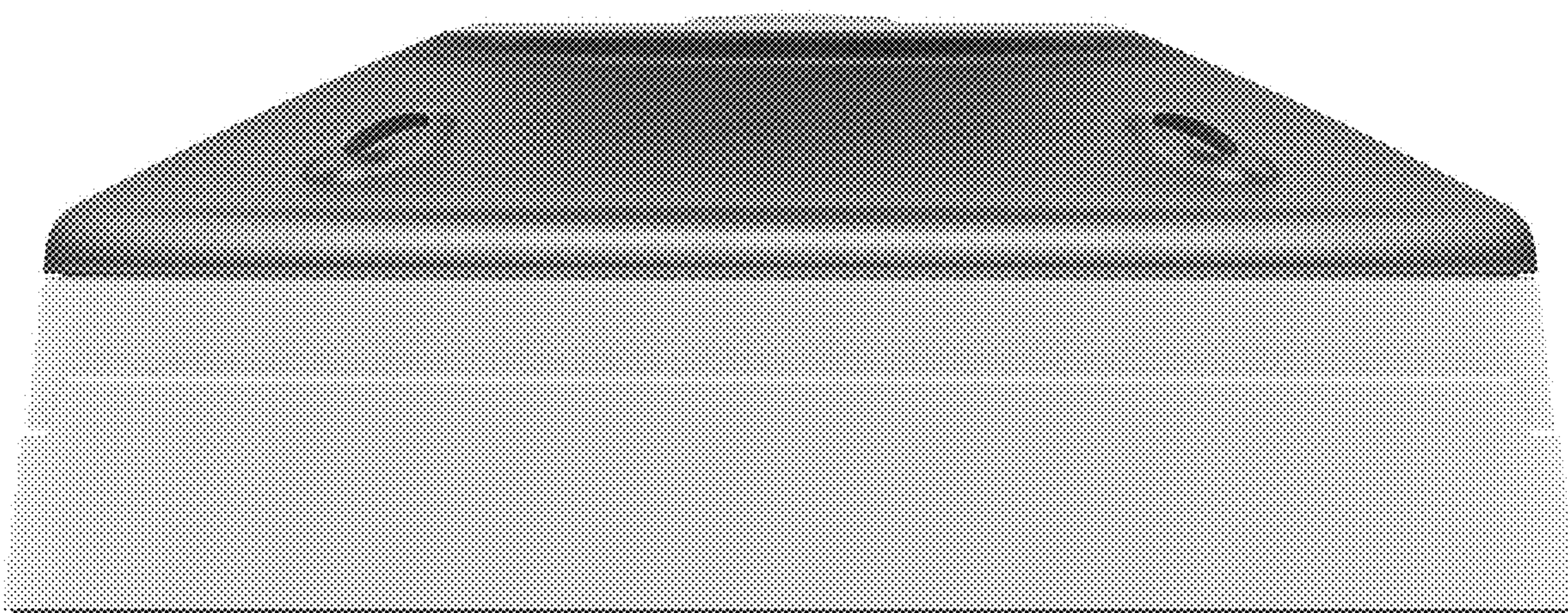

FIG. 7