



US00D948348S

(12) **United States Design Patent**  
**Moynihan**

(10) **Patent No.:** **US D948,348 S**

(45) **Date of Patent:** **\*\* Apr. 12, 2022**

(54) **POUCH FOR LIQUID WITH HANDLE**

(71) Applicant: **David E. Moynihan**, Middlesex, NY  
(US)

(72) Inventor: **David E. Moynihan**, Middlesex, NY  
(US)

(\*\*) Term: **15 Years**

(21) Appl. No.: **29/666,860**

(22) Filed: **Oct. 16, 2018**

(51) **LOC (13) Cl.** ..... **09-05**

(52) **U.S. Cl.**  
USPC ..... **D9/708; D3/202**

(58) **Field of Classification Search**  
USPC ..... D3/207, 208, 215, 226, 228, 229, 230,  
D3/269, 273, 290, 299, 303, 304, 316,  
D3/318, 702, 703, 705, 707, 709, 710,  
D3/202; D9/702-714

CPC ..... B65D 1/00; B65D 1/02; B65D 1/0223;  
B65D 1/24; B65D 1/38; B65D 11/00;  
B65D 11/02; B65D 11/04; B65D 11/10;  
B65D 11/14; B65D 11/20; B65D 20/00;  
B65D 20/02; B65D 20/04; B65D 33/00;  
B65D 33/02; B65D 41/00; B65D 41/02;  
B65D 81/00; B65D 81/02; B65D 47/00;  
B65D 47/02; B65D 47/04; B65D 47/06

See application file for complete search history.

(56) **References Cited**

**U.S. PATENT DOCUMENTS**

D686,088 S \* 7/2013 Murray ..... D9/708  
D703,550 S \* 4/2014 Murray ..... D9/709

D772,723 S \* 11/2016 Murray ..... D9/707  
D777,043 S \* 1/2017 Temple ..... D9/707  
D781,718 S \* 3/2017 Loyd ..... D9/707  
D813,686 S \* 3/2018 Murray ..... D9/708  
D831,500 S \* 10/2018 Moynihan ..... D9/707  
D832,719 S \* 11/2018 Moynihan ..... D9/707  
D845,785 S \* 4/2019 Ferraro ..... D9/708  
D848,277 S \* 5/2019 Murray ..... D9/708  
D854,940 S \* 7/2019 Estlinbaum ..... D9/707  
D901,309 S \* 11/2020 Murray ..... D9/708  
D922,881 S \* 6/2021 Haskins ..... D9/708

\* cited by examiner

*Primary Examiner* — Richard Kearney

*Assistant Examiner* — Benjamin M Weeks

(74) *Attorney, Agent, or Firm* — Theodore J. Bielen, Jr.

(57) **CLAIM**

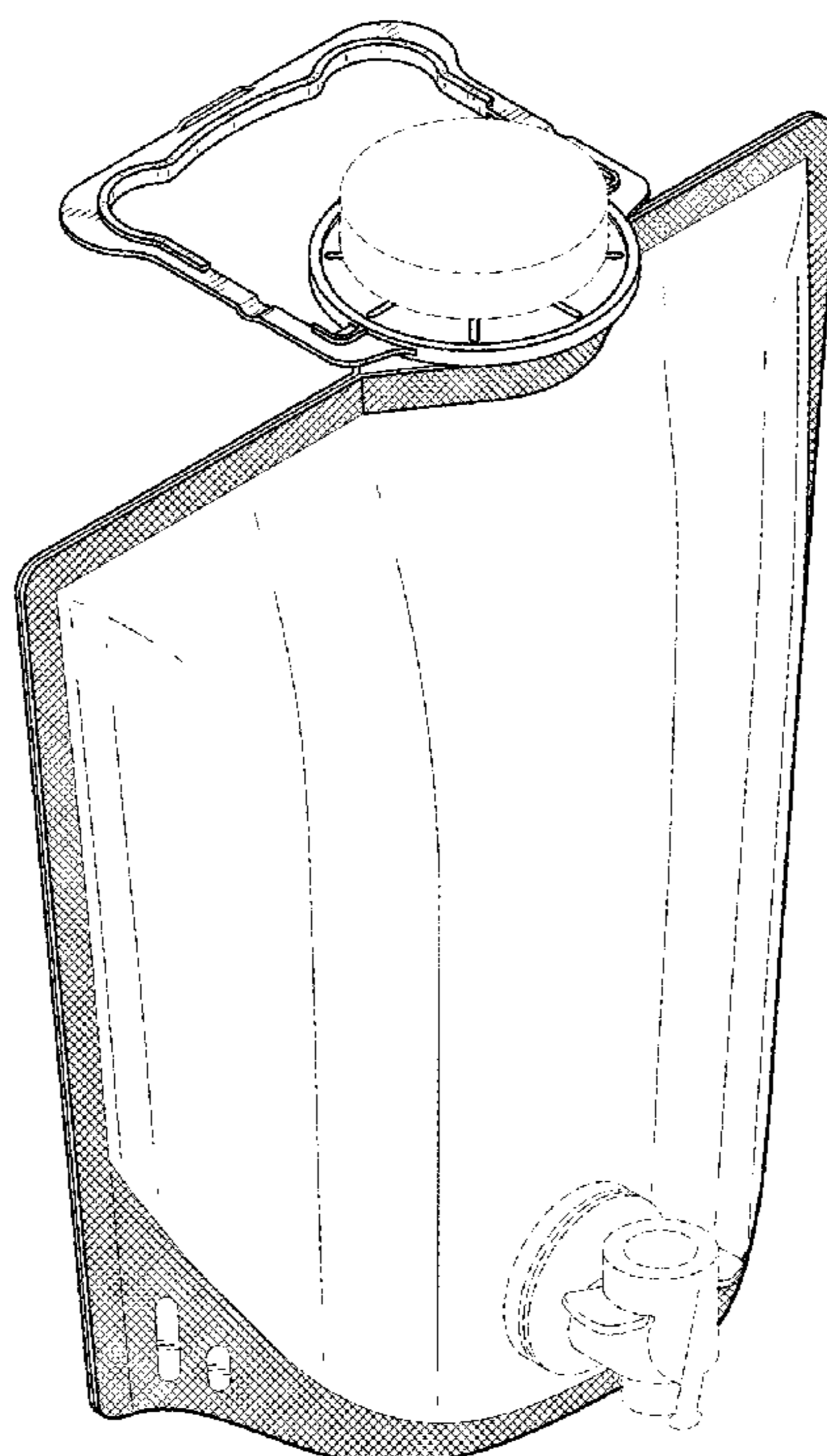
I claim the ornamental design for a pouch for liquid with handle, as shown and described.

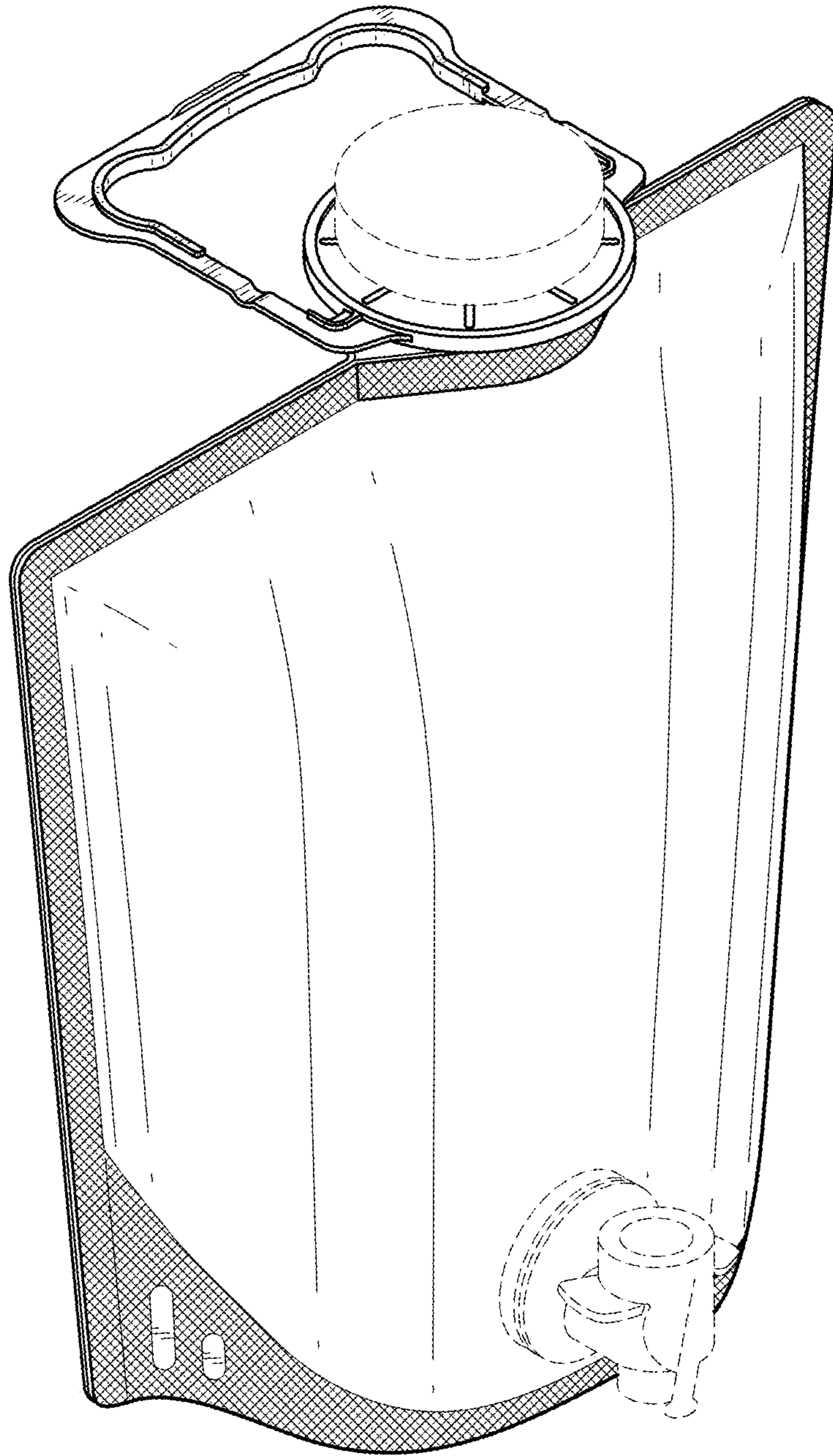
**DESCRIPTION**

FIG. 1 is a top, front, left side perspective view of a pouch for liquid with handle showing my new design;  
FIG. 2 is a front elevational view thereof;  
FIG. 3 is a rear elevational view thereof;  
FIG. 4 is a top plan view thereof;  
FIG. 5 is a left side elevational view, the right side elevational view being a mirror image thereof; and,  
FIG. 6 is a bottom plan view.

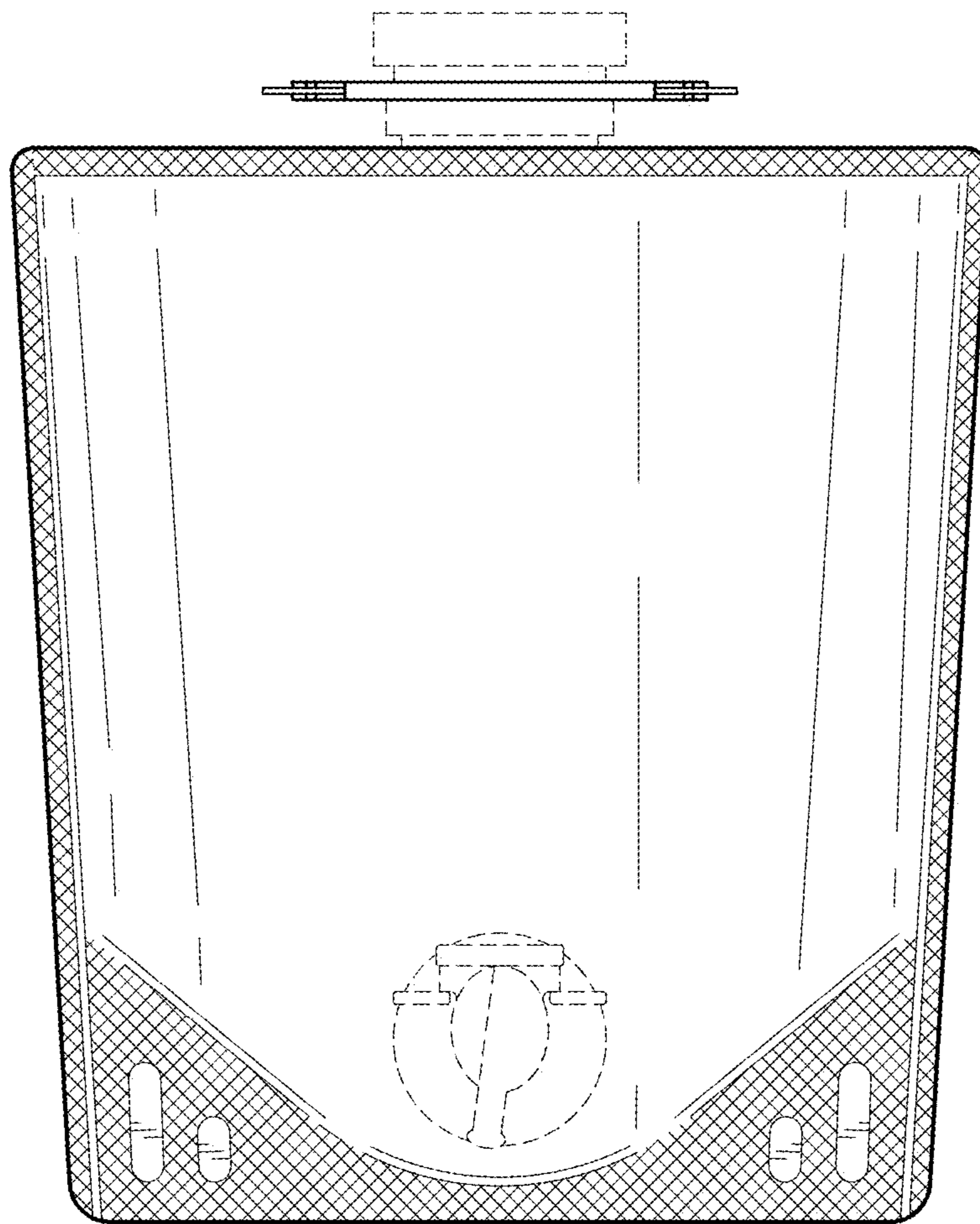
The broken line showing of the article is included for the purpose of illustrating portions of the article and forms no part of the claimed design.

**1 Claim, 6 Drawing Sheets**

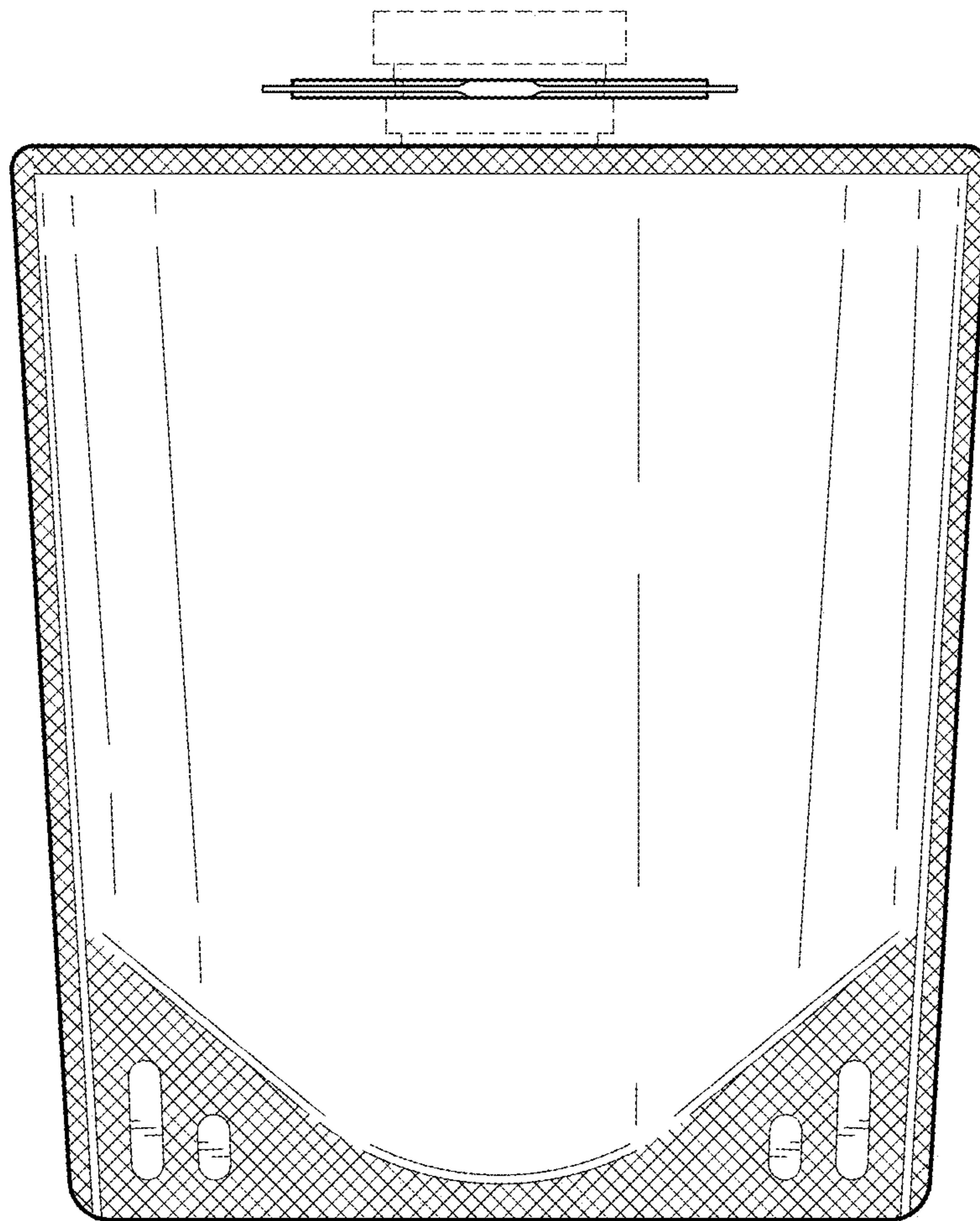




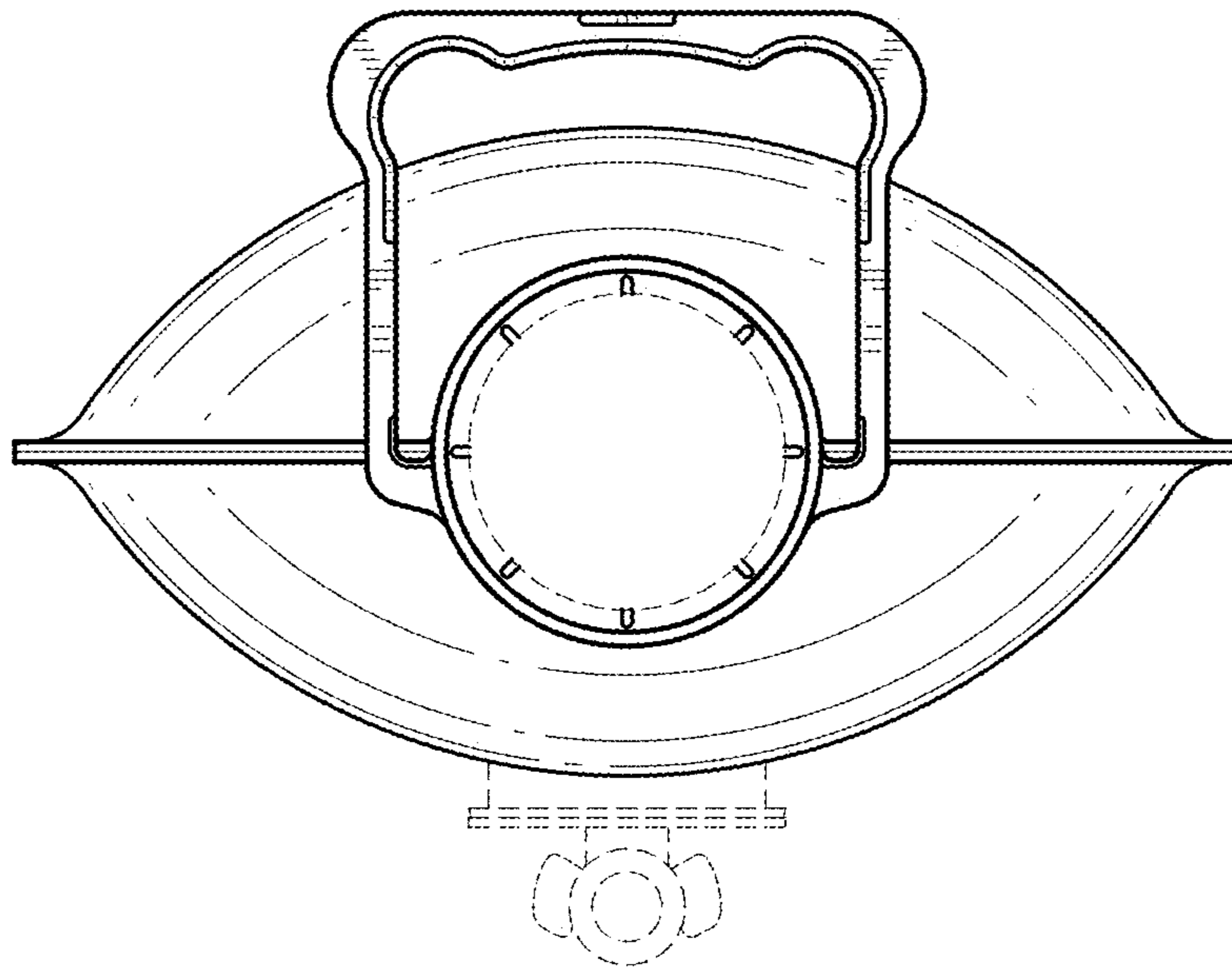
**FIG. 1**



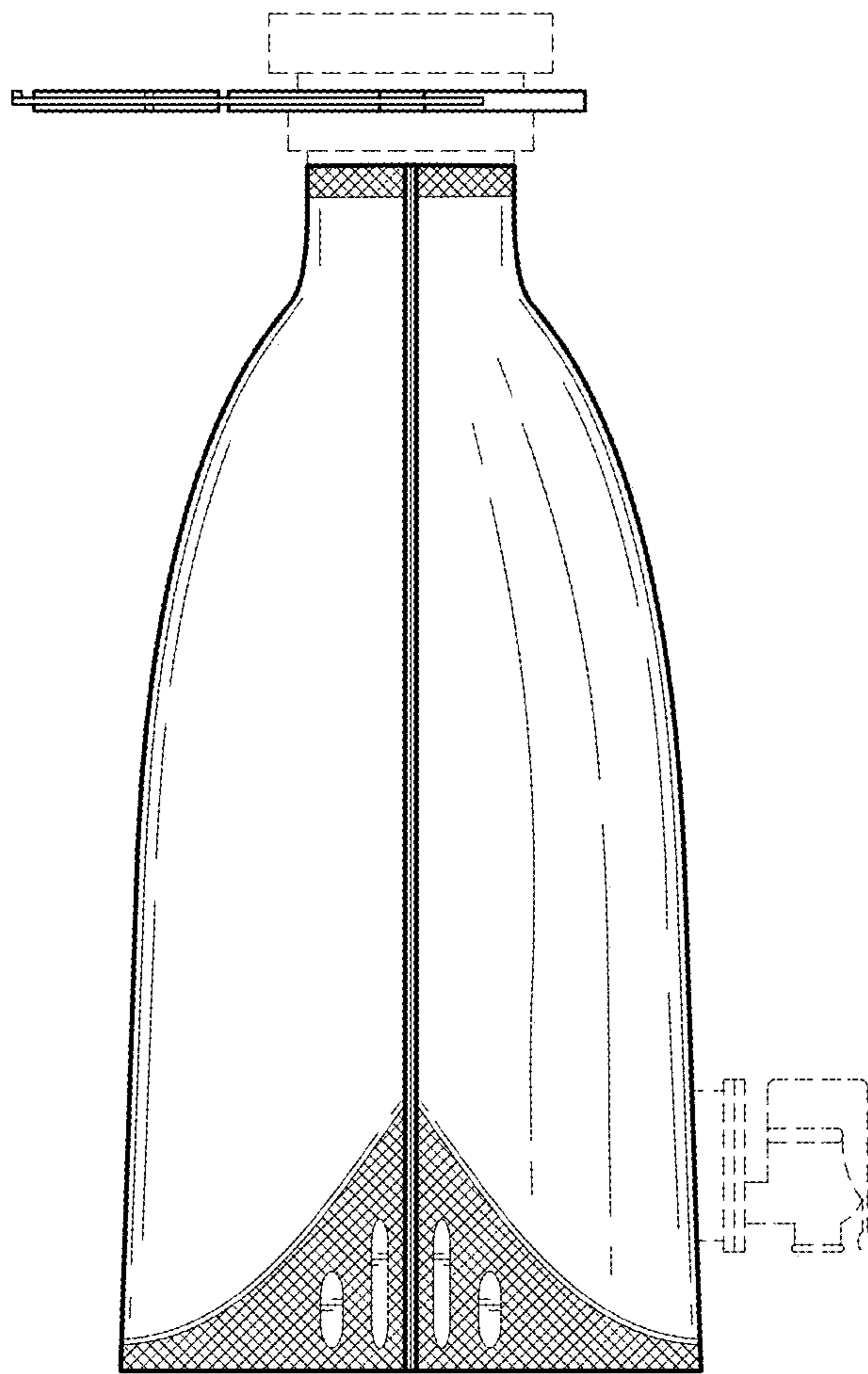
**FIG. 2**



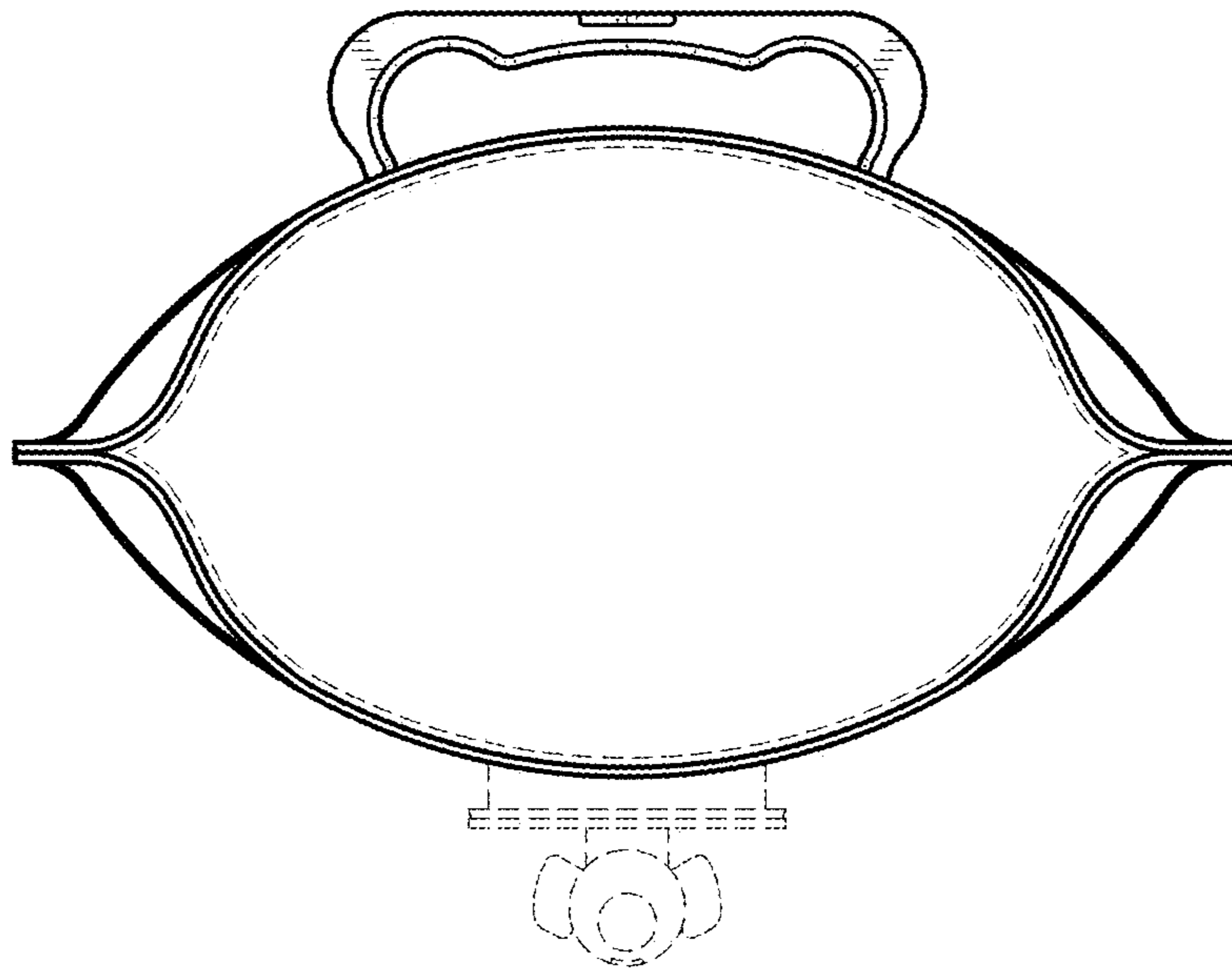
**FIG. 3**



**FIG. 4**



**FIG. 5**



**FIG. 6**