



US00D948332S

(12) **United States Design Patent** (10) **Patent No.:** **US D948,332 S**
Song (45) **Date of Patent:** **** Apr. 12, 2022**

(54) **CONTAINER**

(71) Applicant: **REYNOLDS CONSUMER PRODUCTS LLC**, Lake Forest, IL (US)

(72) Inventor: **Seung Hyuck Song**, Seoul (KR)

(73) Assignee: **REYNOLDS CONSUMER PRODUCTS LLC**, Lake Forest, IL (US)

(**) Term: **15 Years**

(21) Appl. No.: **29/727,527**

(22) Filed: **Mar. 11, 2020**

(51) **LOC (13) Cl.** **09-03**

(52) **U.S. Cl.**
USPC **D9/425**

(58) **Field of Classification Search**
USPC D7/400, 601, 608; D9/416, 417, 420, D9/425-429, 430, 432, 761
(Continued)

(56) **References Cited**

U.S. PATENT DOCUMENTS

D539,100 S * 3/2007 Zhao D7/629
D592,500 S * 5/2009 Colacitti D7/354
(Continued)

Primary Examiner — Janice Patyk

(74) *Attorney, Agent, or Firm* — Baker Botts L.L.P.

(57) **CLAIM**

The ornamental design for a container, as shown and described.

DESCRIPTION

FIG. 1 is a top perspective view of a container, of embodiment one, shown without the lid for ease of illustration, showing my new design;

FIG. 2 is a front view thereof, the rear view being the same, shown without the lid for ease of illustration;

FIG. 3 is a side view thereof, the opposite side view being the same, shown without the lid for ease of illustration;

FIG. 4 is a top view thereof, shown without the lid for ease of illustration;

FIG. 5 is a bottom view thereof, shown without the lid for ease of illustration;

FIG. 6 is a top perspective view thereof, shown without the base for ease of illustration;

FIG. 7 is a front view thereof, the rear view being the same, shown without the base for ease of illustration;

FIG. 8 is a side view thereof, the opposite side being the same, shown without the base for ease of illustration;

FIG. 9 is a top view thereof, shown without the base for ease of illustration;

FIG. 10 is a bottom view thereof, shown without the base for ease of illustration;

FIG. 11 is a top perspective view thereof;

FIG. 12 is a front view thereof, the rear view being the same;

FIG. 13 is a side view thereof, the opposite side view being the same;

FIG. 14 is a top view thereof;

FIG. 15 is a bottom view thereof;

FIG. 16 is a top perspective view of a container, of embodiment two, shown without the lid for ease of illustration, showing my new design;

FIG. 17 is a front view thereof, the rear view being the same, shown without the lid for ease of illustration;

FIG. 18 is a side view thereof, the opposite side view being the same, shown without the lid for ease of illustration;

FIG. 19 is a top view thereof, shown without the lid for ease of illustration;

FIG. 20 is a bottom view thereof, shown without the lid for ease of illustration;

FIG. 21 is a top perspective view thereof;

FIG. 22 is a front view thereof, the rear view being the same;

FIG. 23 is a side view thereof, the opposite side view being the same;

FIG. 24 is a top view thereof; and,

FIG. 25 is a bottom view thereof.

(Continued)

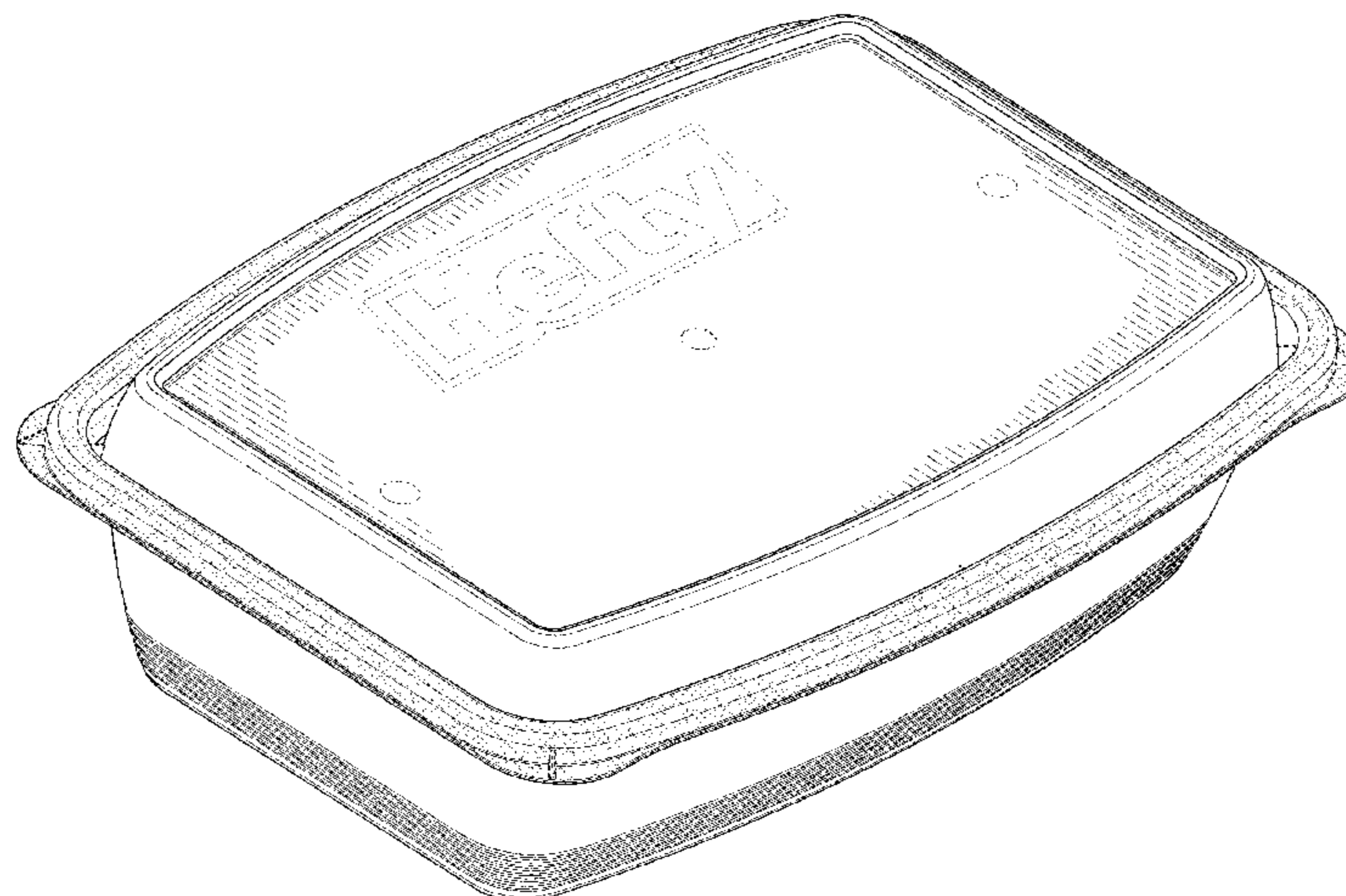

The broken lines in the figures illustrate the portions of the design that form no part of the claimed design.

1 Claim, 25 Drawing Sheets

(58) Field of Classification Search

CPC ... B65D 1/00; B65D 1/26; B65D 1/34; B65D 1/40; B65D 11/00; B65D 11/20; B65D 21/00; B65D 21/02; B65D 21/0209; B65D 21/0233; B65D 81/34; B65D 81/3446; B65D 81/3453; B65D 2581/34; B65D 2581/3404; B65D 2581/3409

See application file for complete search history.

(56) References Cited

U.S. PATENT DOCUMENTS

D606,812	S	*	12/2009	Wu	D7/629
D614,950	S	*	5/2010	Colacitti	D9/425
D724,903	S	*	3/2015	Chen	D7/629
D755,579	S	*	5/2016	Wu	D7/629
D772,058	S	*	11/2016	Urushidani	D9/432
D841,462	S	*	2/2019	Kui	D9/425
D852,038	S	*	6/2019	Hirst	D9/425
D852,039	S	*	6/2019	Troudt	D9/425

* cited by examiner

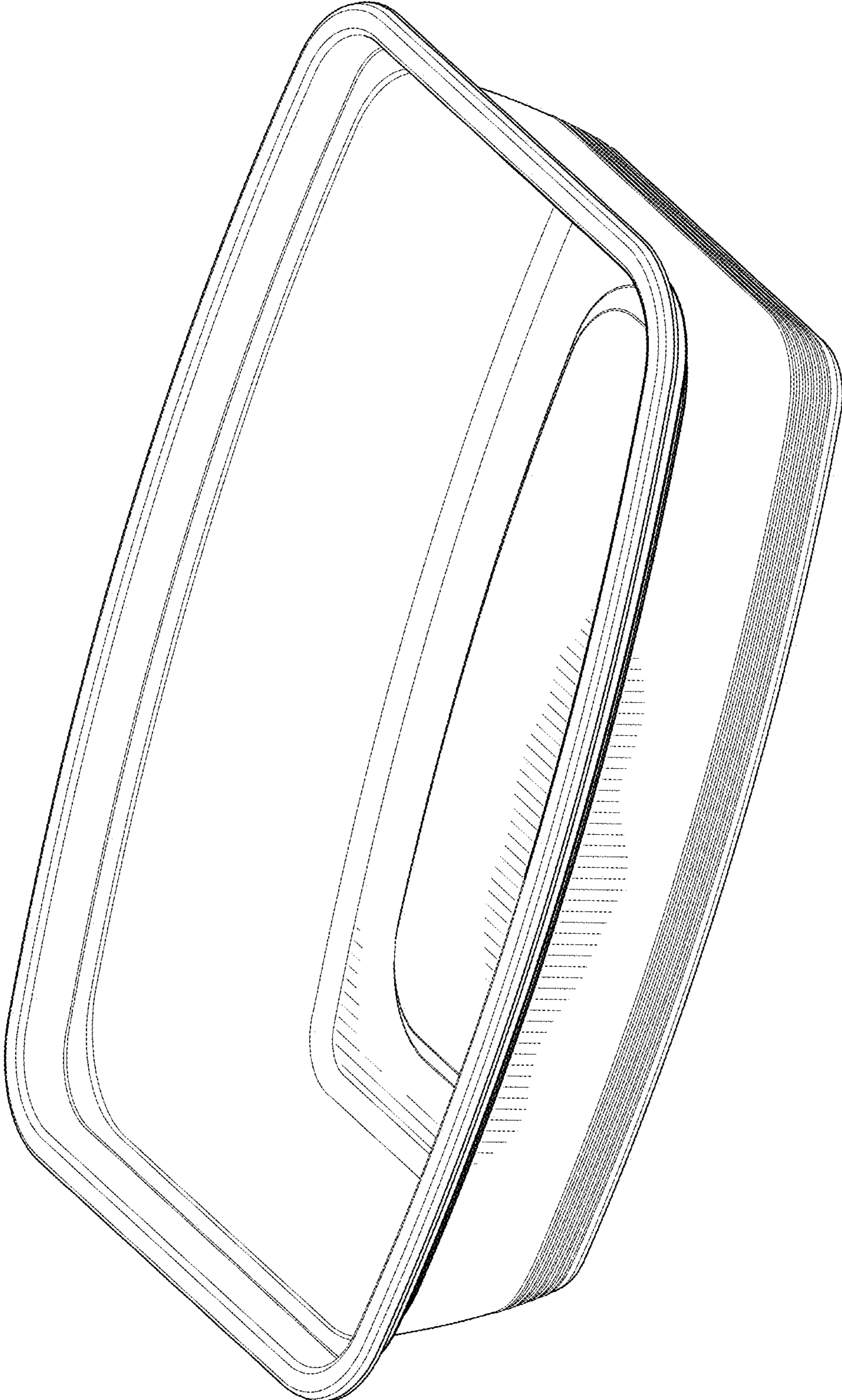

FIG. 1

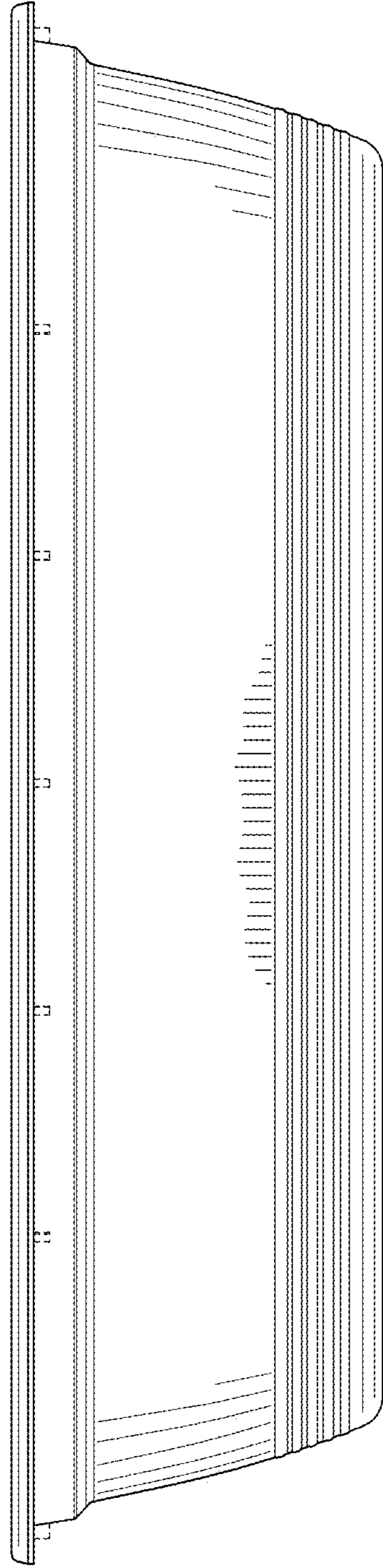

FIG. 2

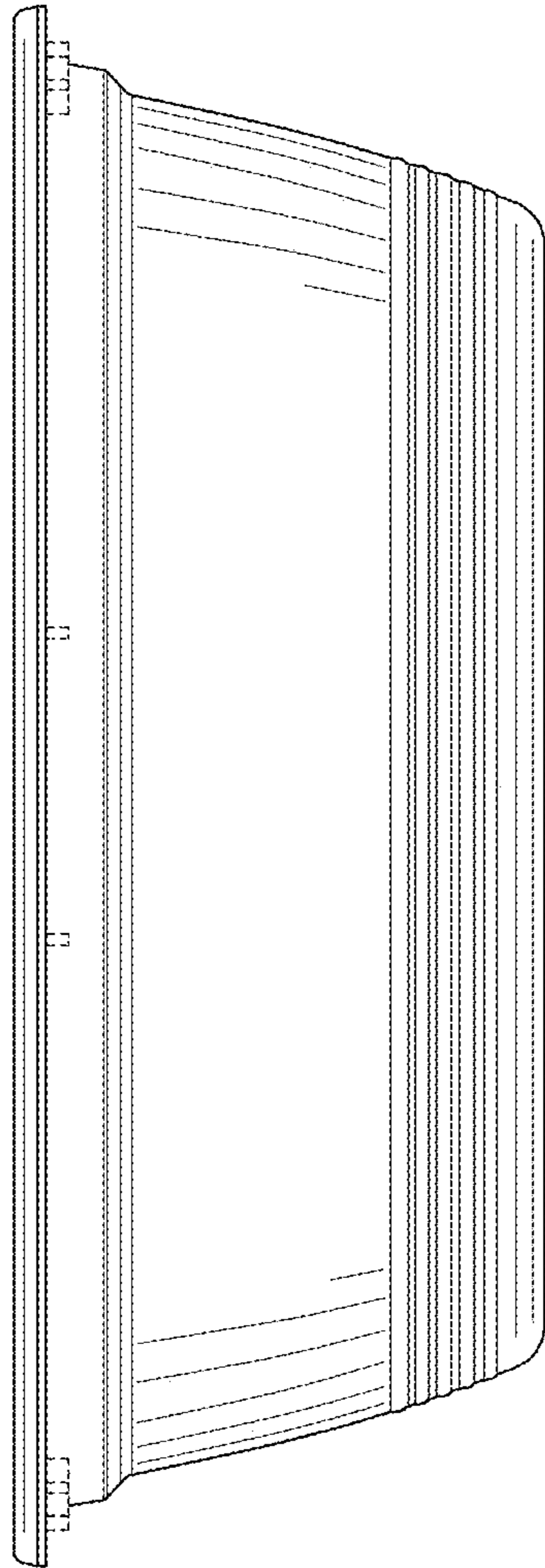

FIG. 3

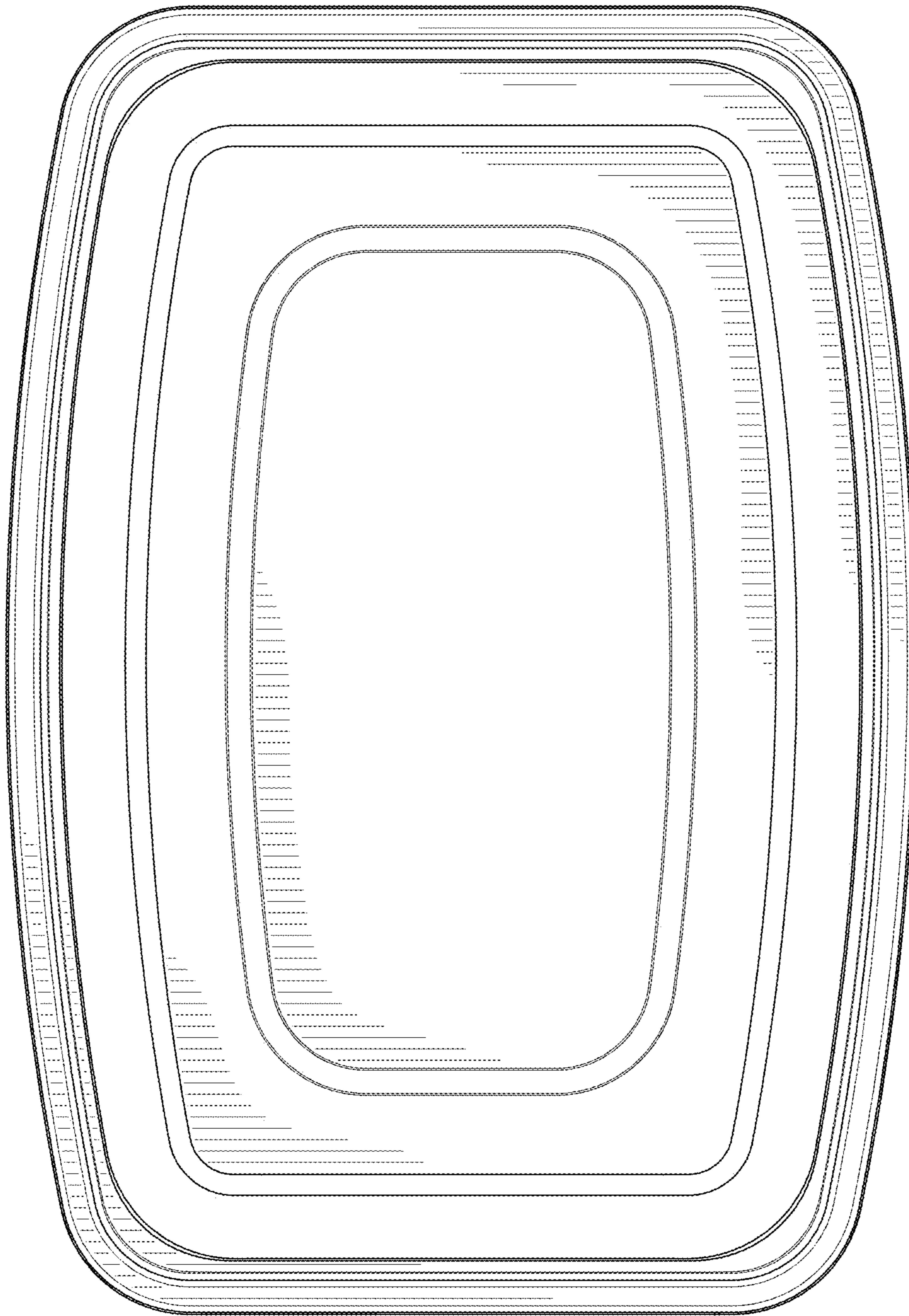

FIG. 4

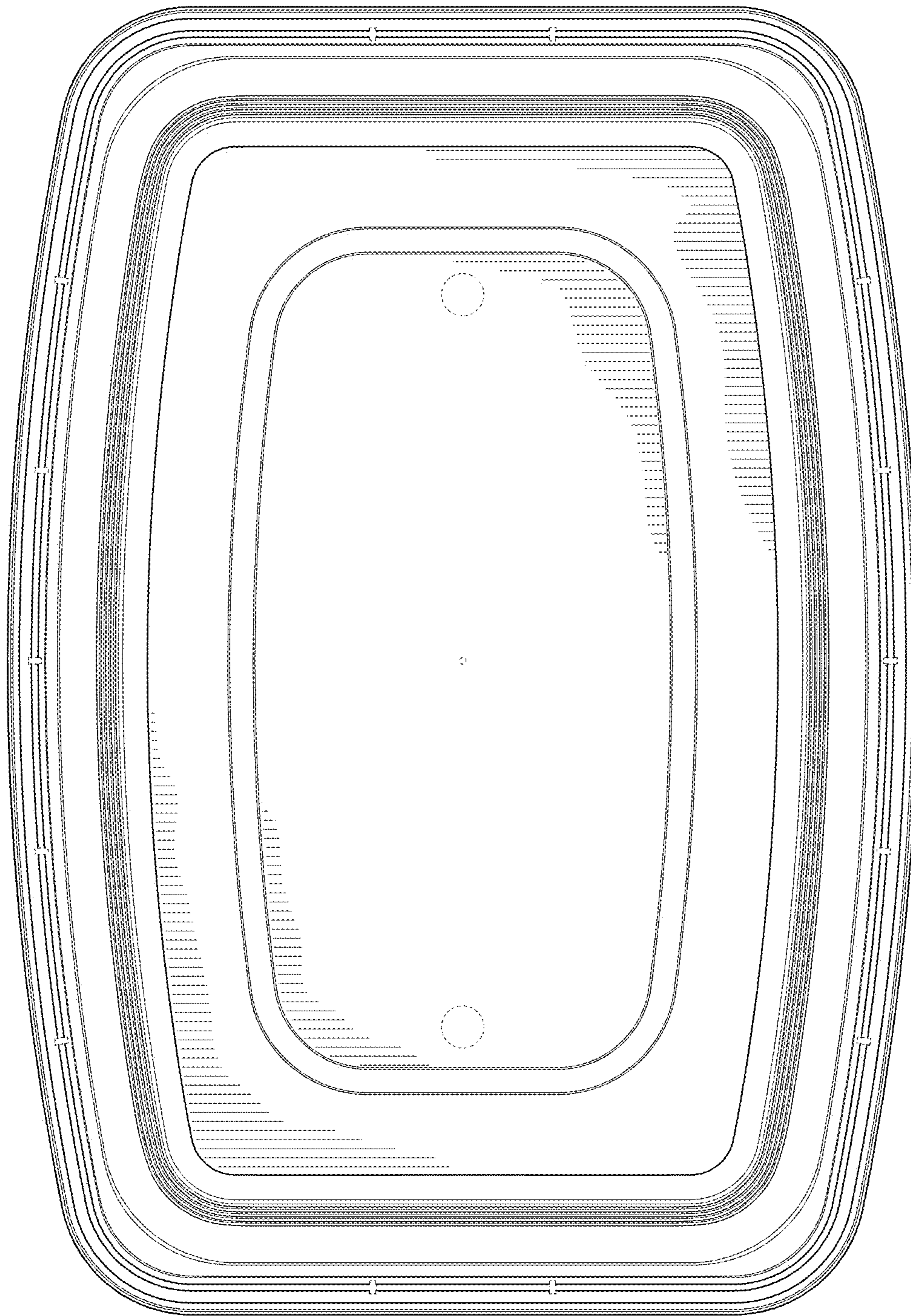

FIG. 5

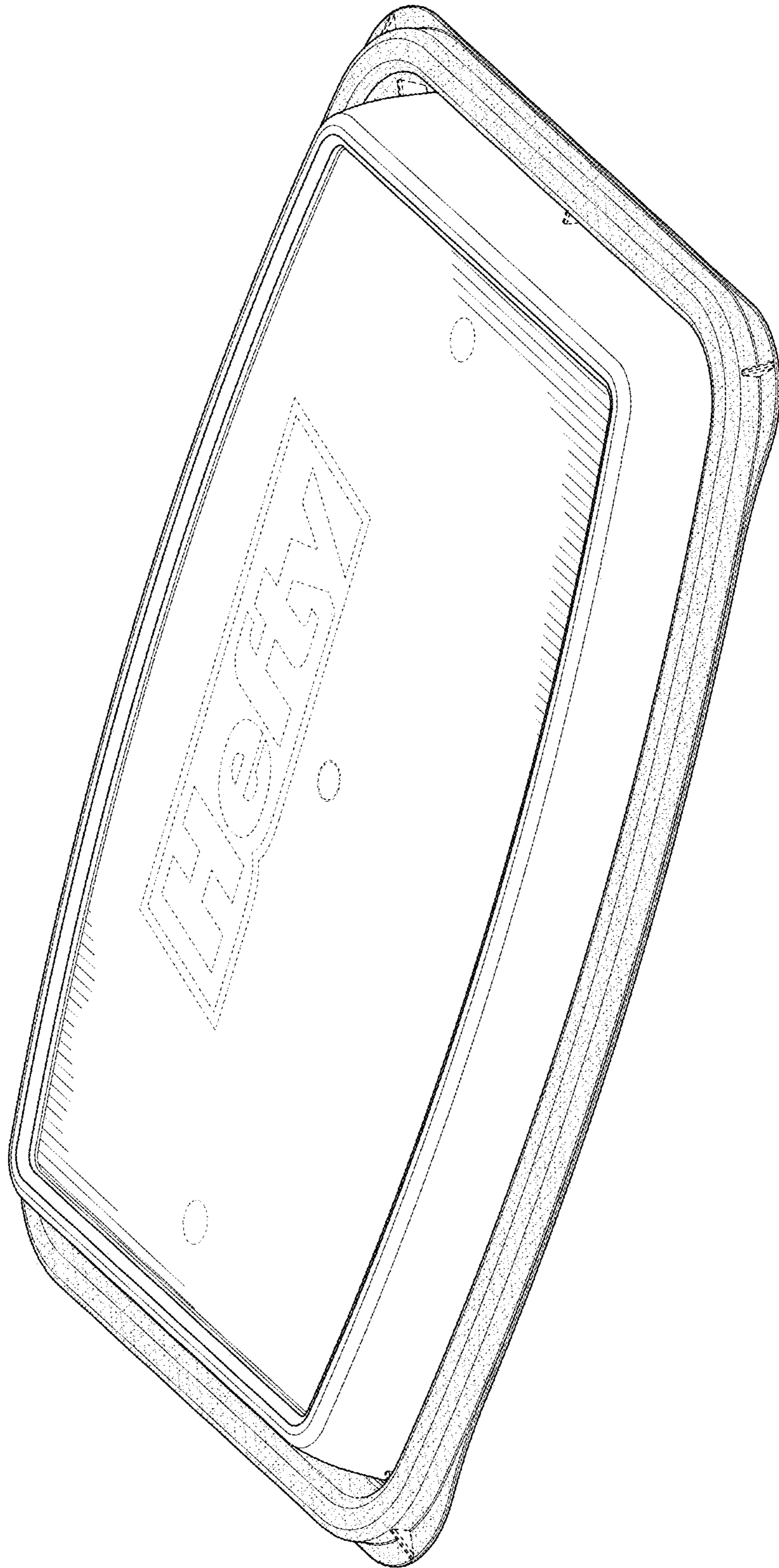

FIG. 6

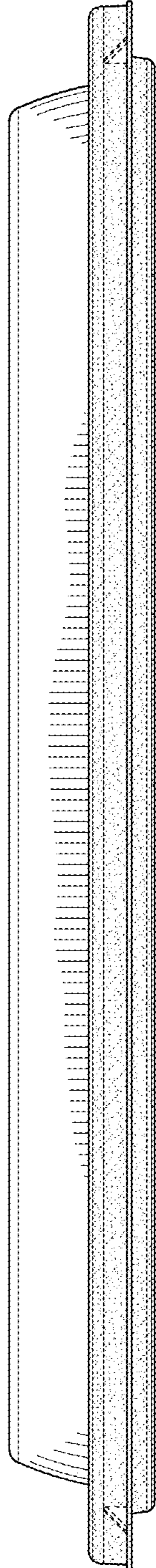

FIG. 7

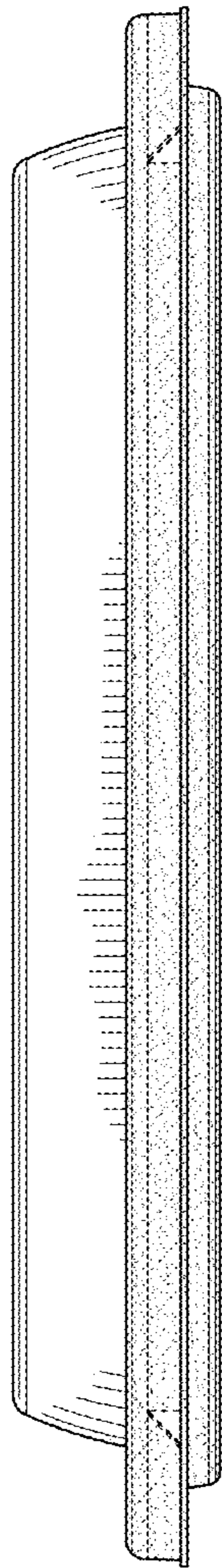

FIG. 8



FIG. 9

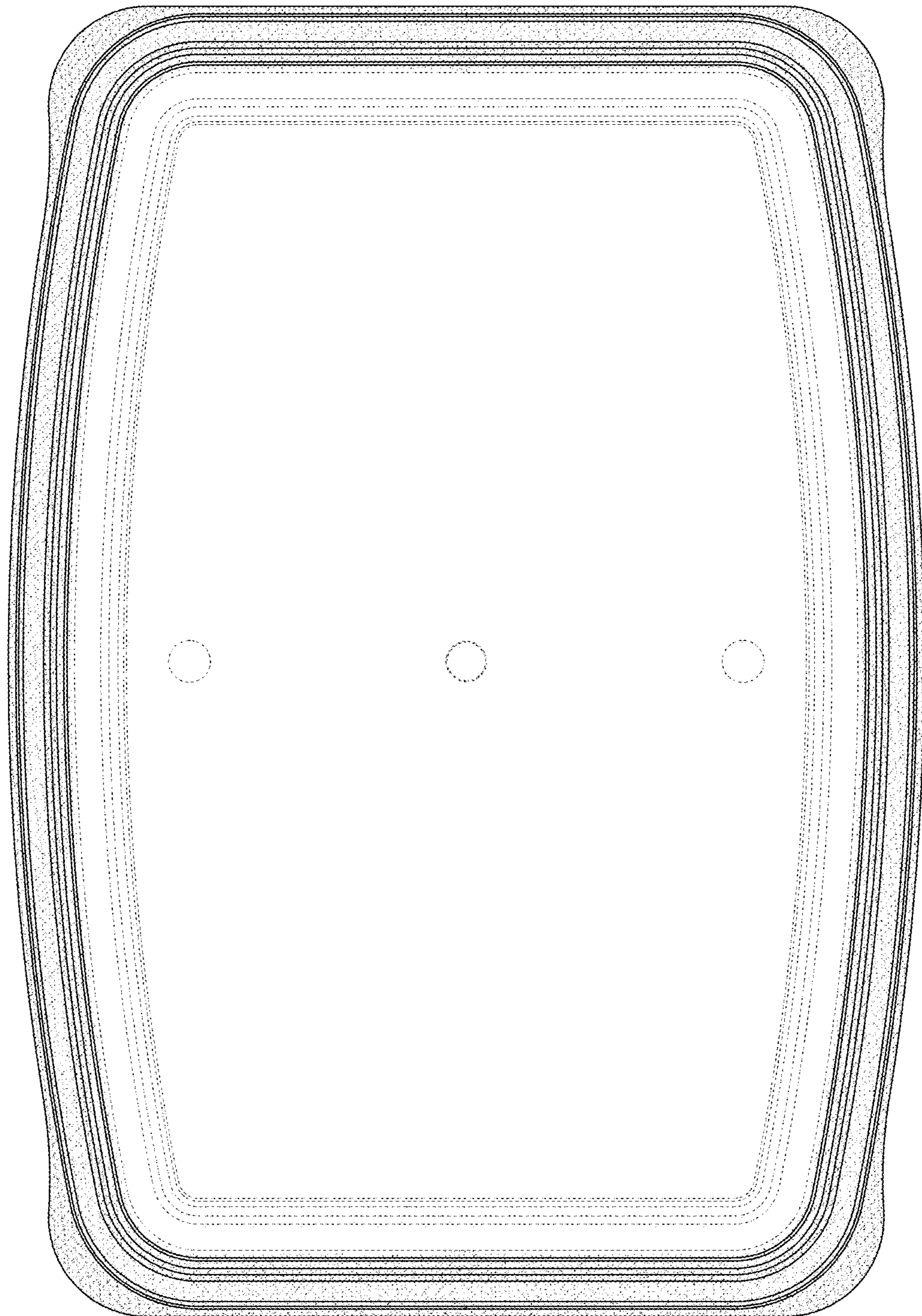

FIG. 10

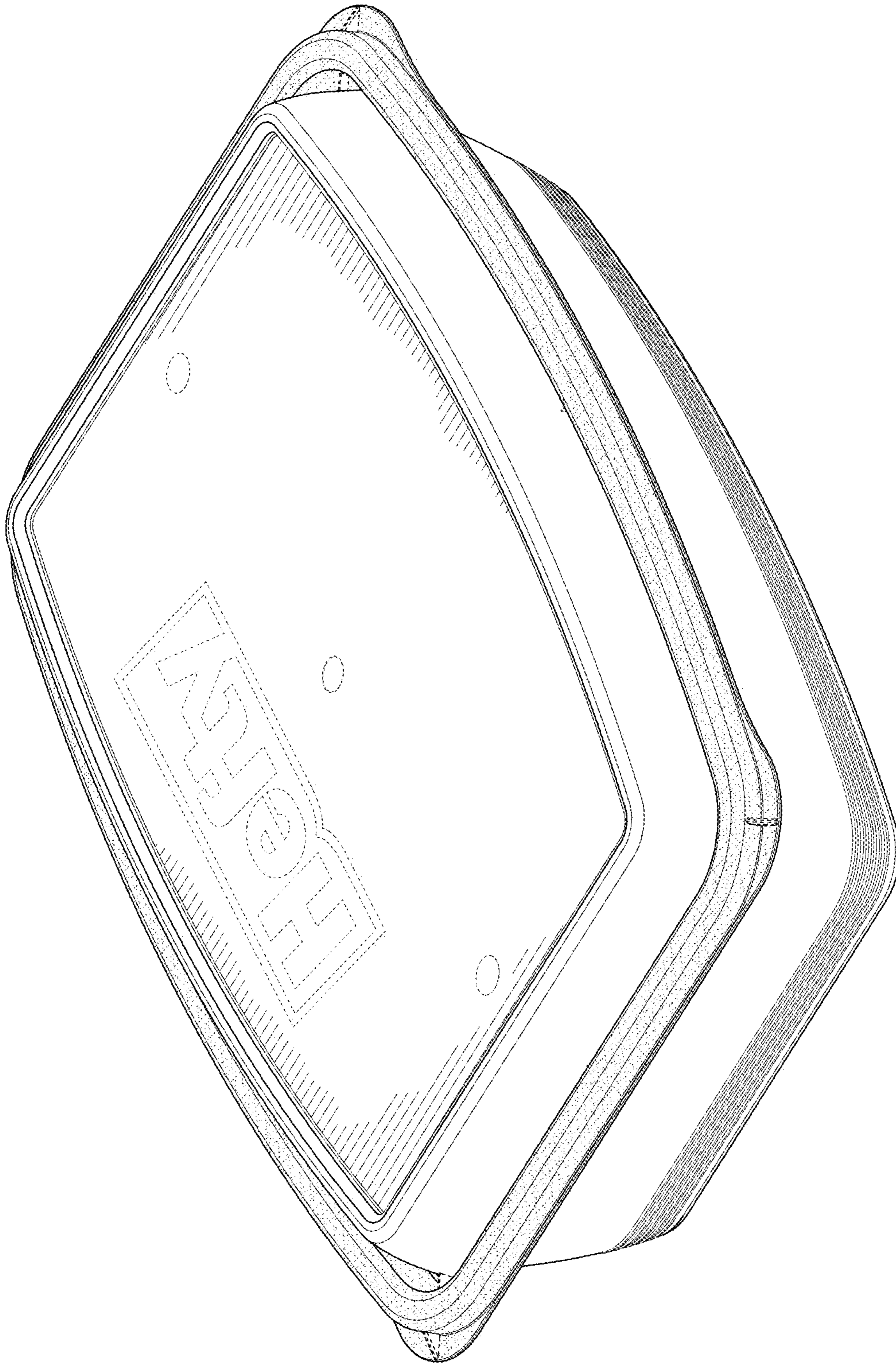

FIG. 11

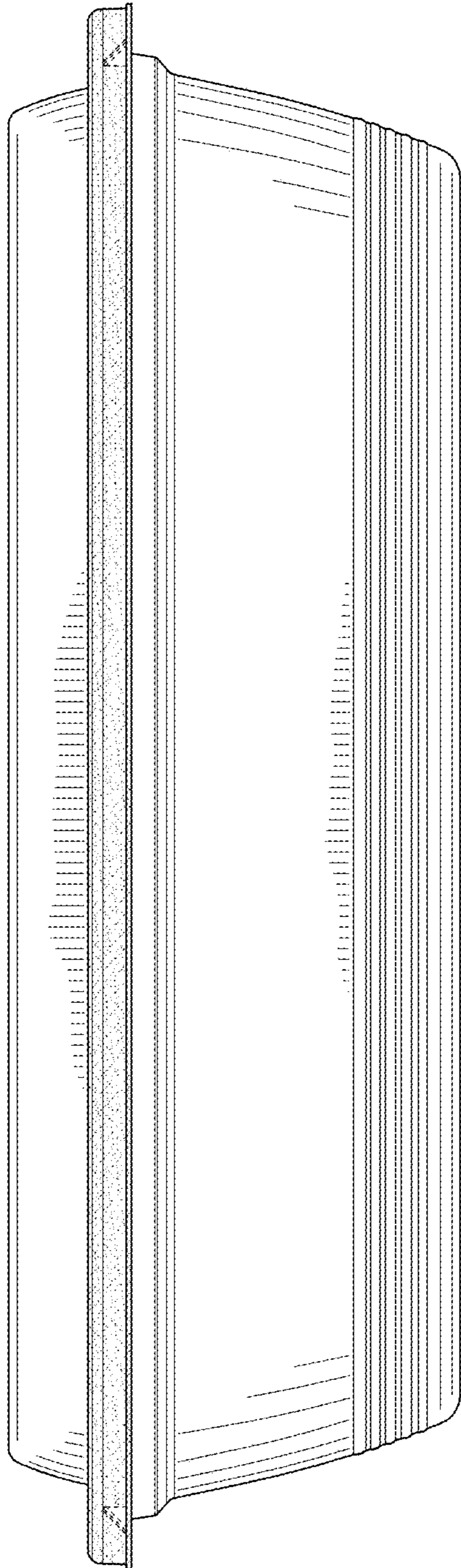

FIG. 12

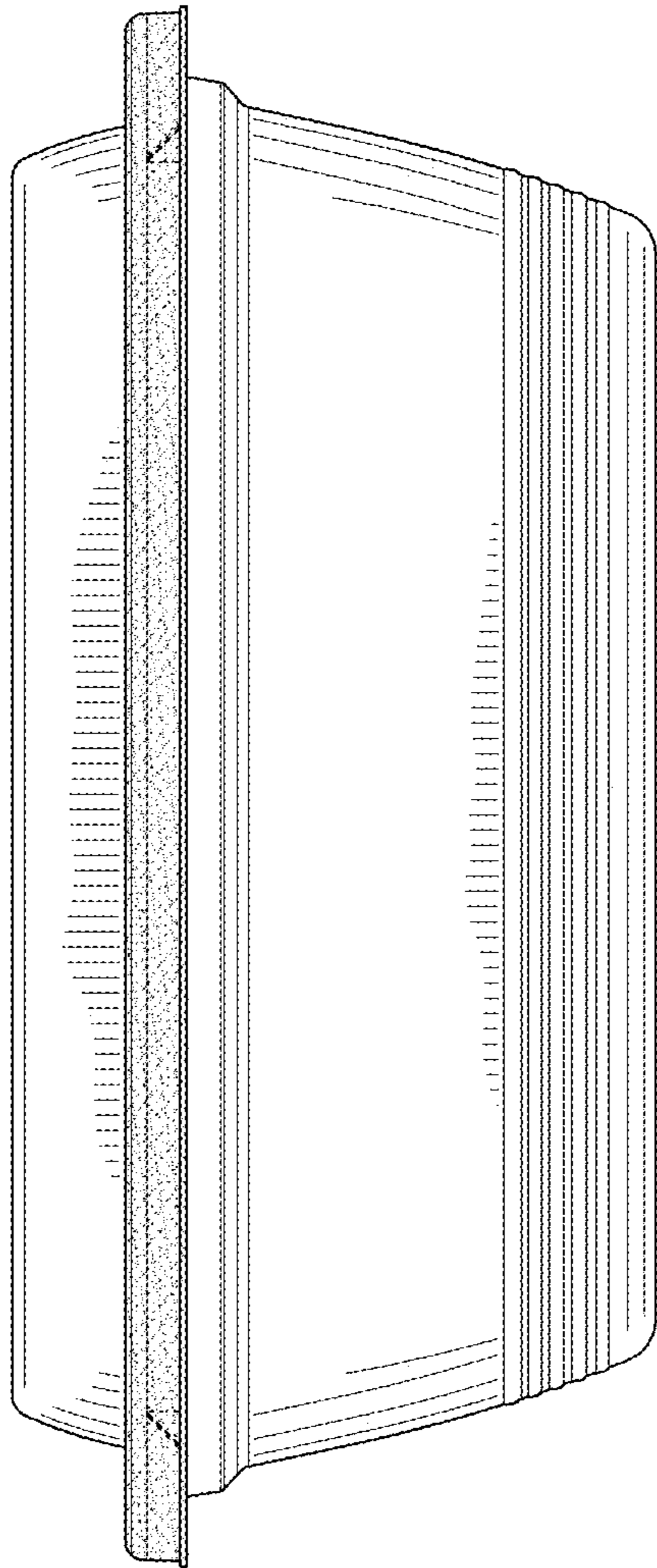

FIG. 13



FIG. 14

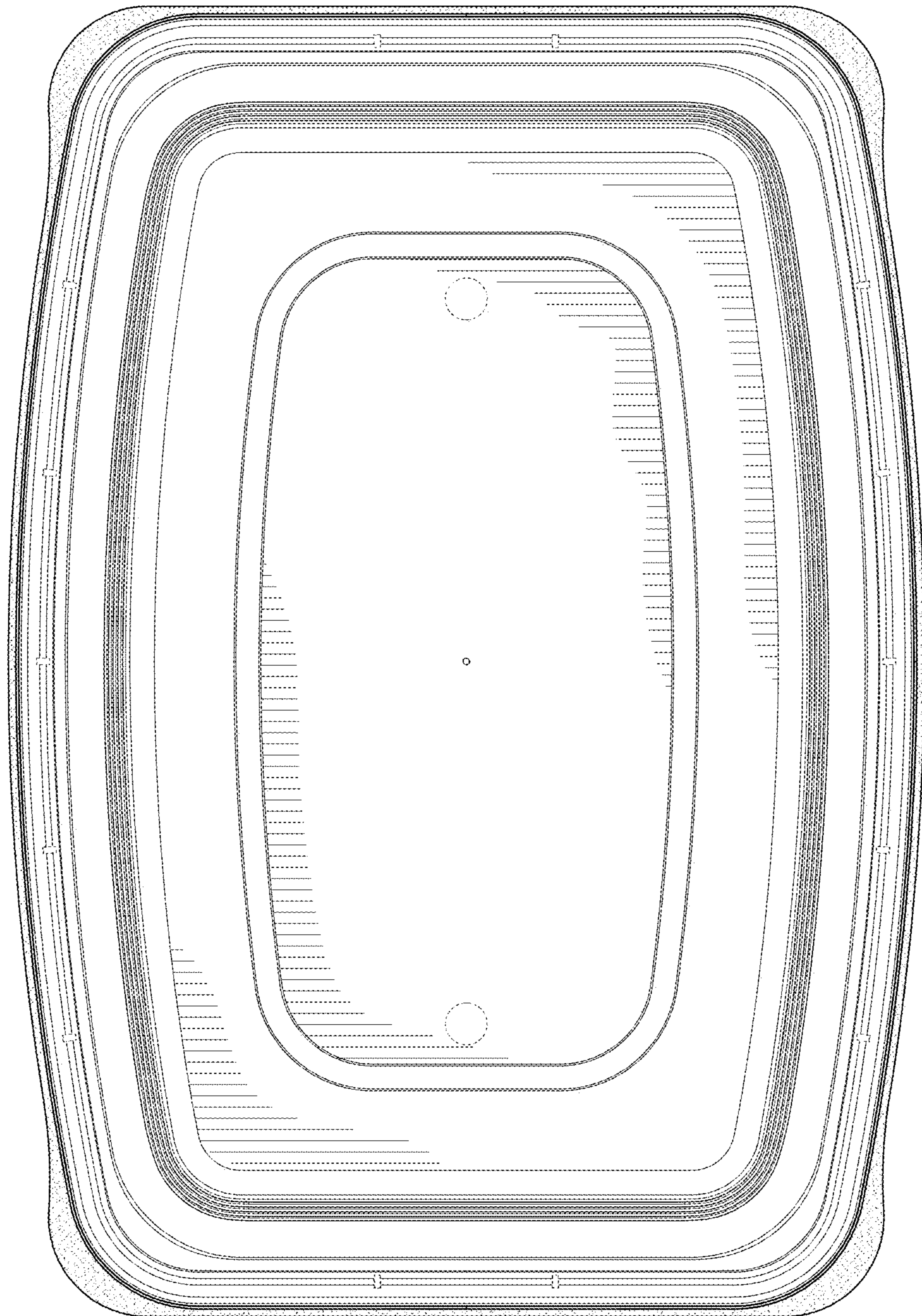

FIG. 15

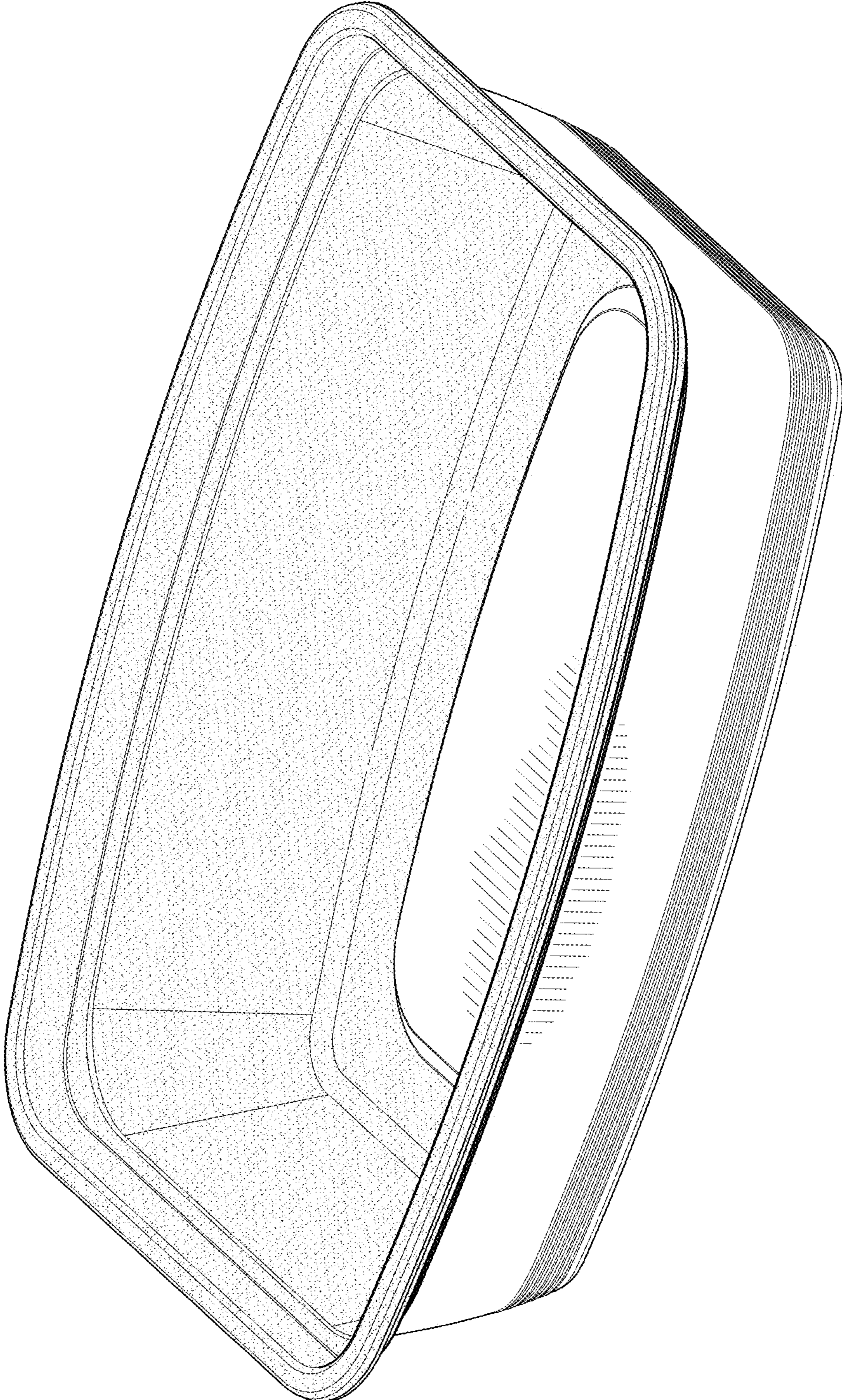

FIG. 16

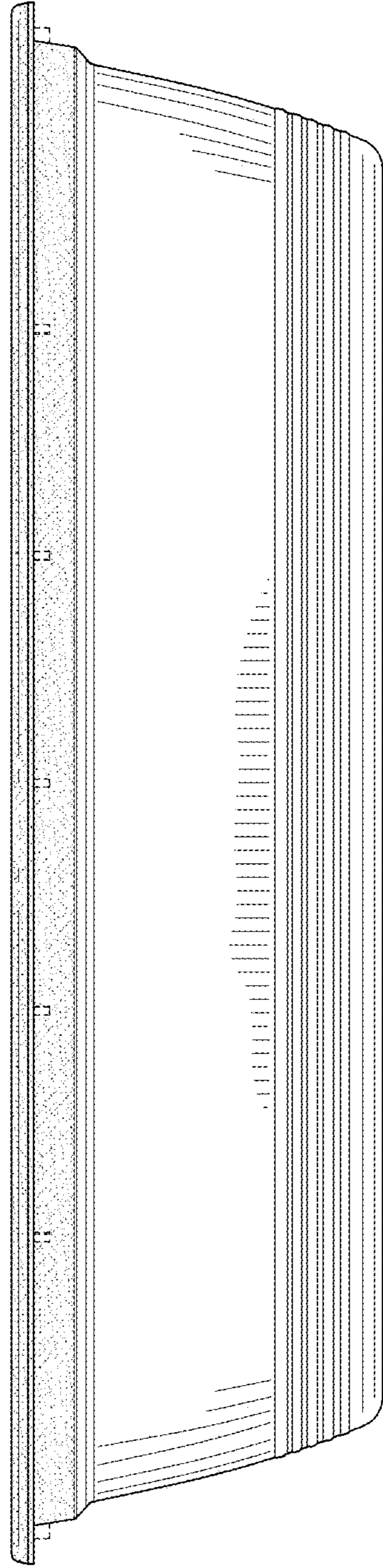

FIG. 17

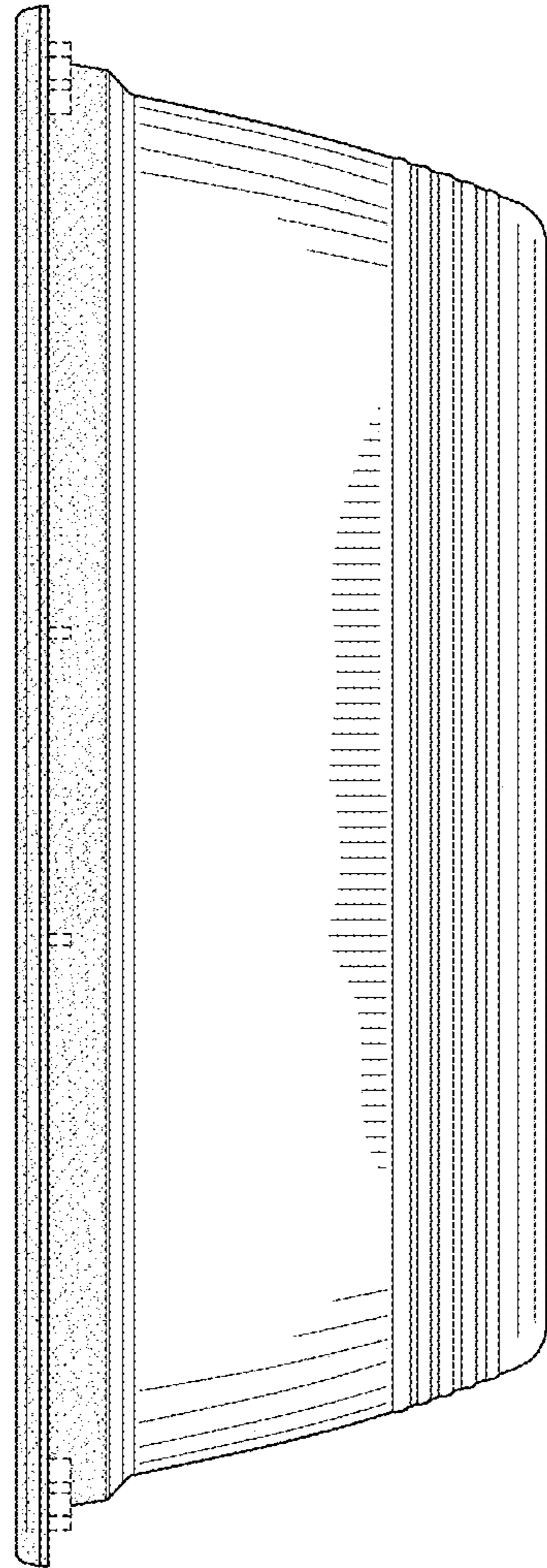

FIG. 18

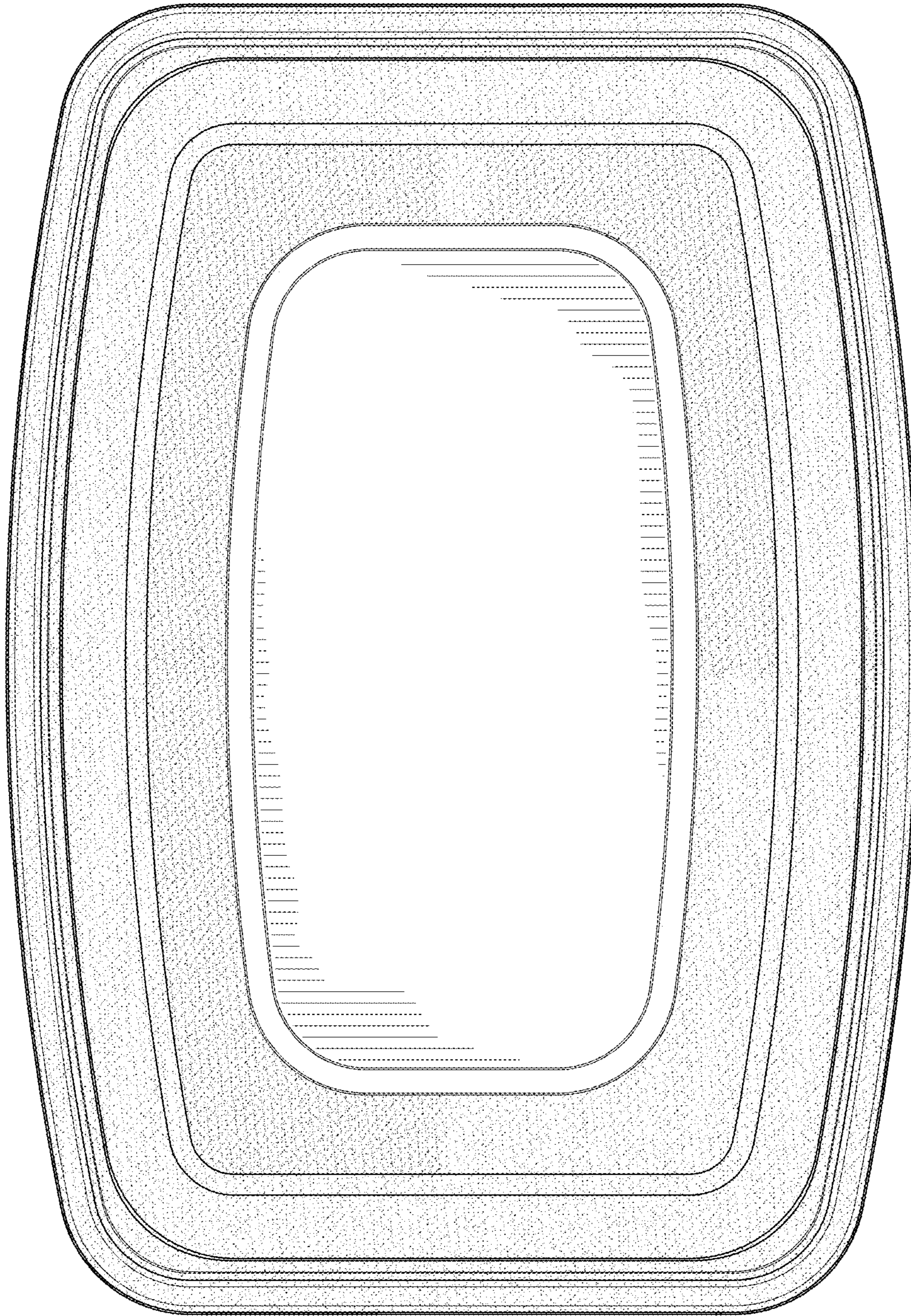

FIG. 19

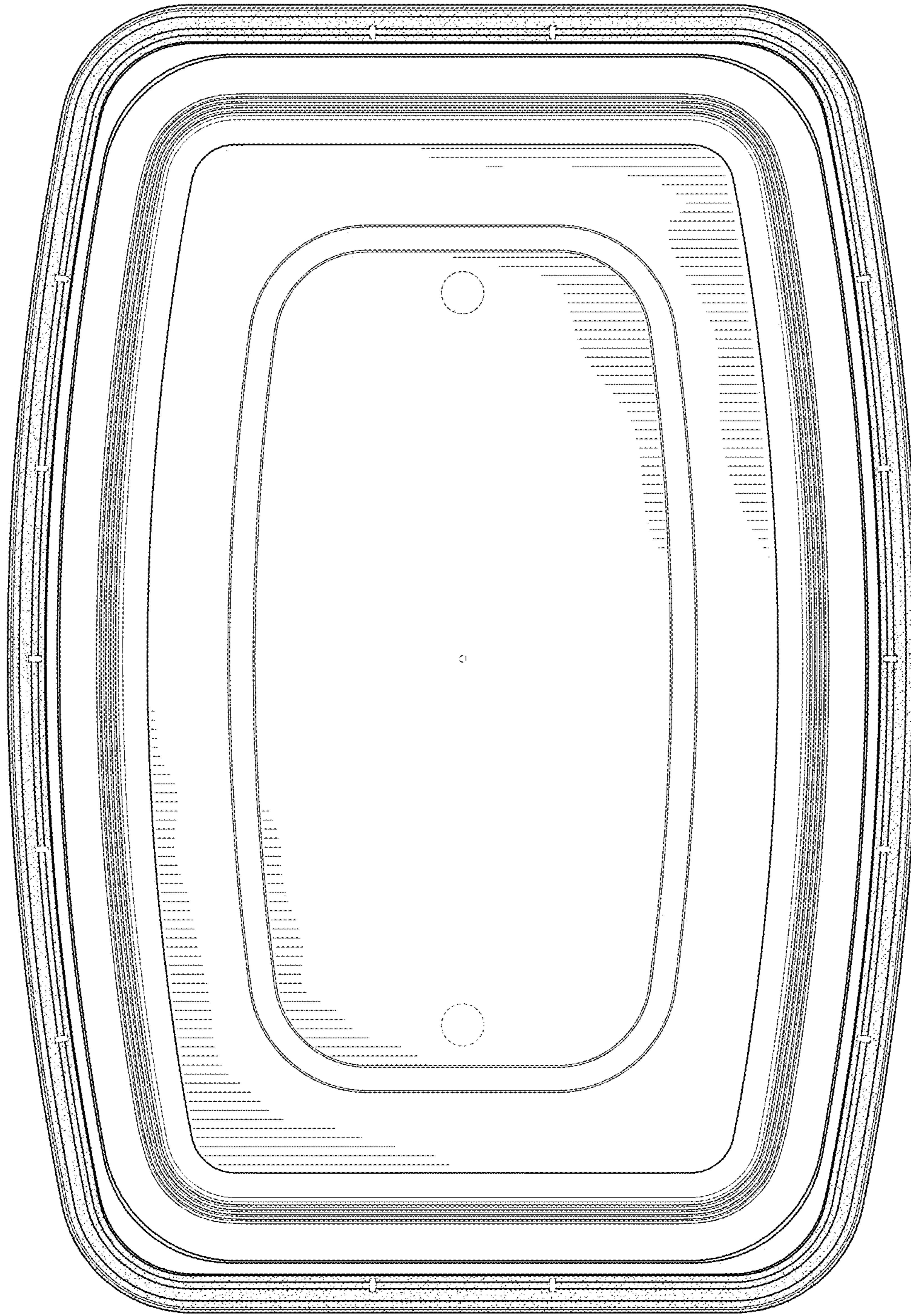

FIG. 20

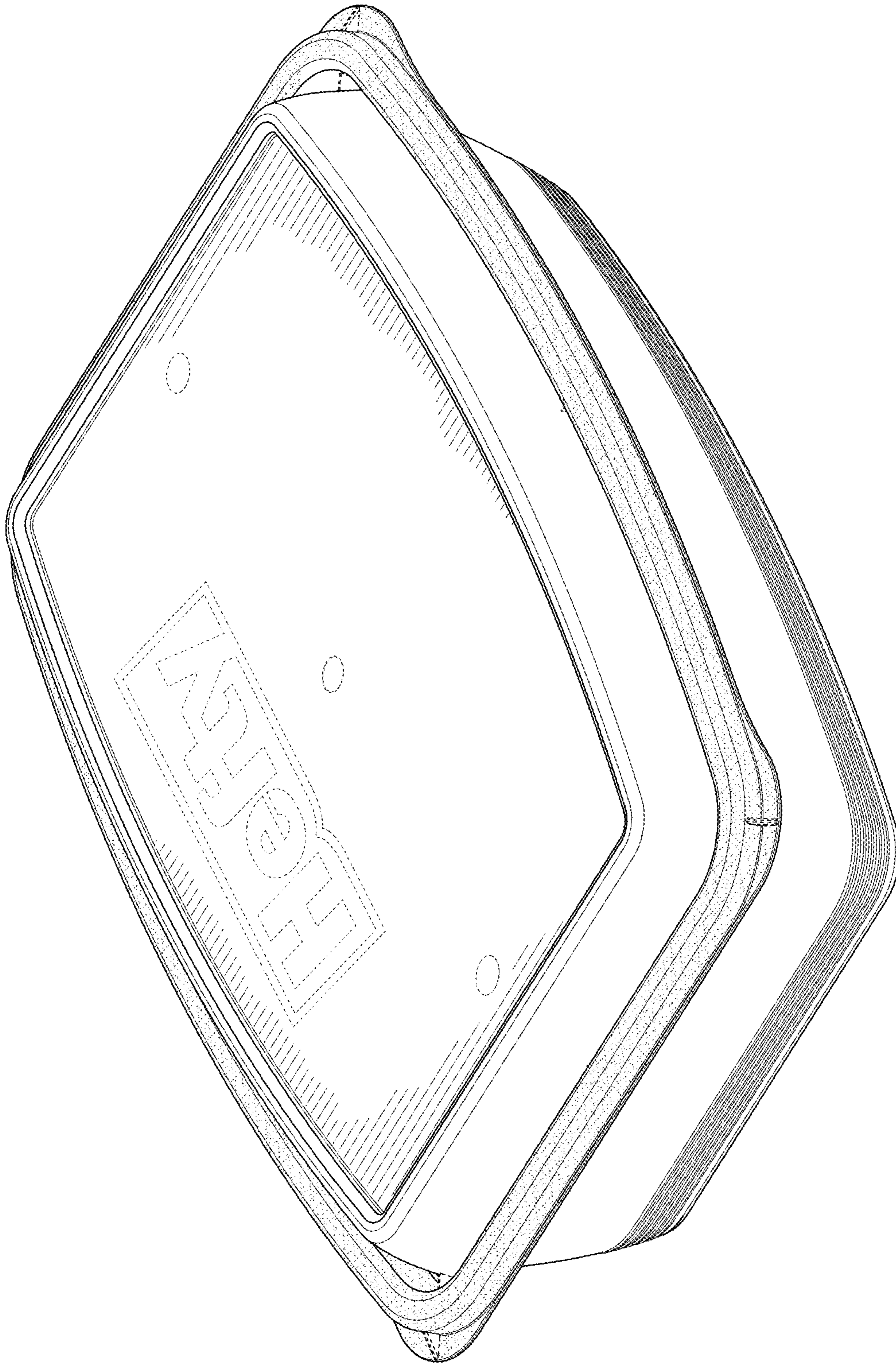

FIG. 21

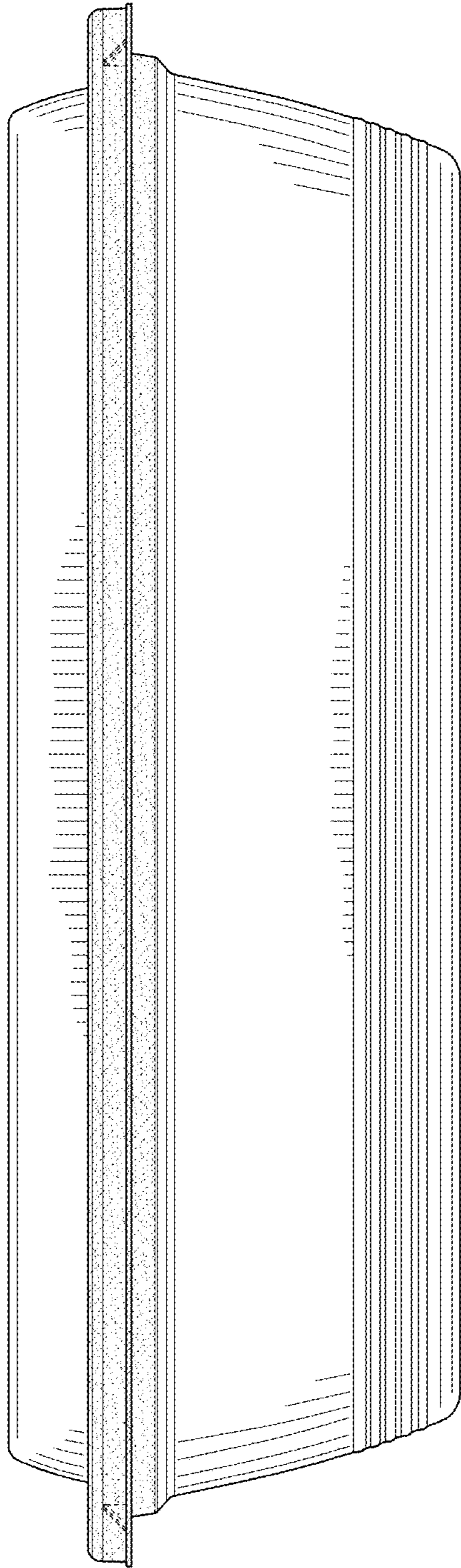

FIG. 22

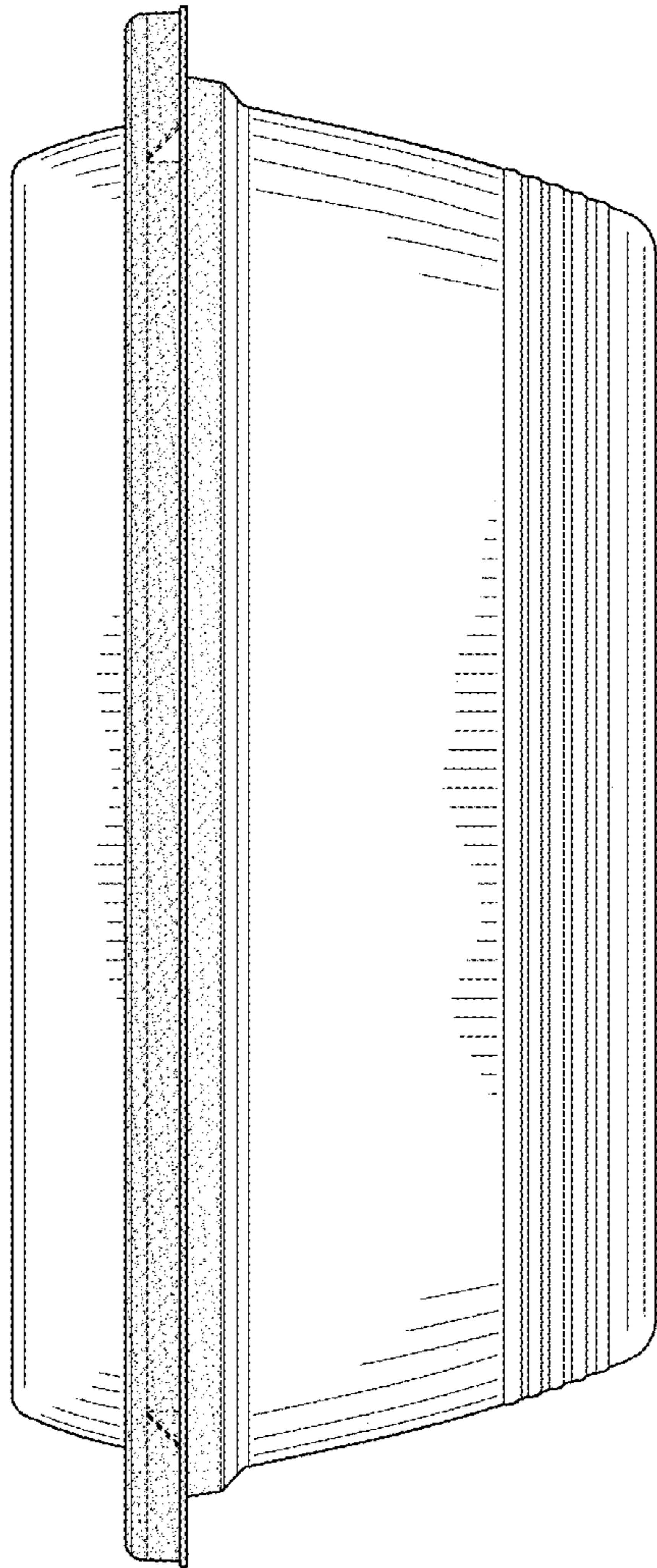

FIG. 23



FIG. 24

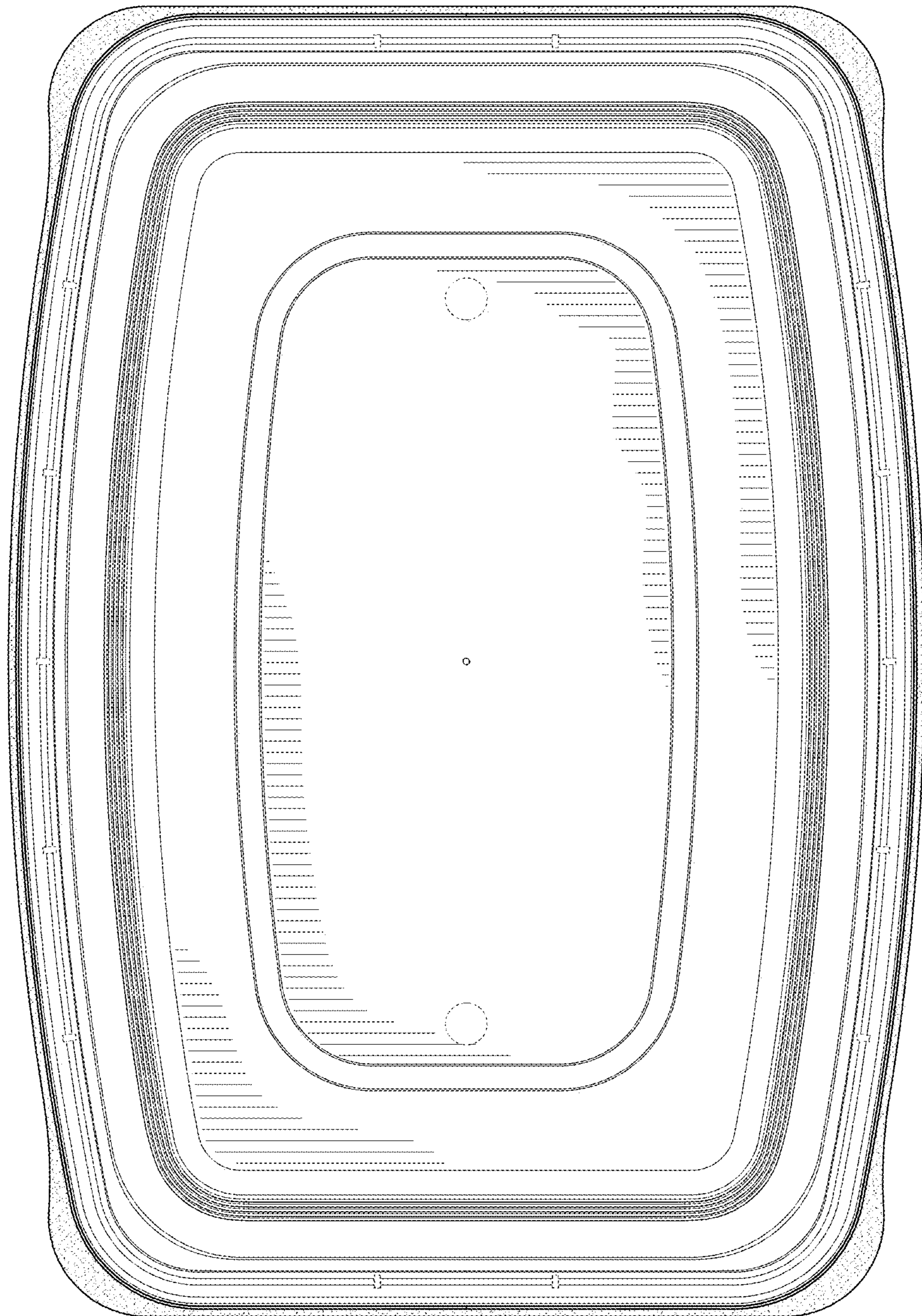

FIG. 25