



US00D948215S

(12) **United States Design Patent**
Spaander et al.

(10) **Patent No.:** **US D948,215 S**
(45) **Date of Patent:** **** Apr. 12, 2022**

(54) **CONTAINER**

(71) Applicant: **Keter Luxembourg Sarl**, Niedercorn (LU)

(72) Inventors: **Hanna Spaander**, Tel Aviv (IL);
Yaacov Haham, Ashkelon (IL)

(73) Assignee: **KETER LUXEMBOURG SARL**, Niedercorn (LU)

(**) Term: **15 Years**

(21) Appl. No.: **29/700,856**

(22) Filed: **Aug. 6, 2019**

(30) **Foreign Application Priority Data**

Feb. 6, 2019 (IL) 63301

(51) **LOC (13) Cl.** **09-04**

(52) **U.S. Cl.**

USPC **D3/304; D9/432**

(58) **Field of Classification Search**

USPC D6/675, 556; D3/304, 298, 307, 308,
D3/309, 312, 314, 315; D9/414, 416,

(Continued)

(56) **References Cited**

U.S. PATENT DOCUMENTS

D646,119 S * 10/2011 Deuber D7/400
D678,052 S * 3/2013 Bakker D9/433

(Continued)

FOREIGN PATENT DOCUMENTS

CN 303017490 * 12/2014
CN 303017491 * 12/2014
JP D1120956 * 9/2001

OTHER PUBLICATIONS

IKEA Kuggis Box with Lid: Announced [Jun. 13, 2018, online]. Site Visited [Jan. 28, 2021, online]. Available from Internet URL: <https://www.amazon.com/IKEA-Kuggis-White-Size-602-802-05/dp/B07DPTQ55W> (Year: 2018).*

(Continued)

Primary Examiner — Leanne Was-Englehart

(74) *Attorney, Agent, or Firm* — Vorys, Sater, Seymour and Pease LLP; William L. Klima

(57) **CLAIM**

The ornamental design for a container, as shown and described.

DESCRIPTION

FIG. 1 is a top isometric view of a container;
FIG. 2 is a bottom isometric view thereof;
FIG. 3 is a front view thereof;
FIG. 4 is a rear view thereof;
FIG. 5 is a left side view thereof;
FIG. 6 is a right side view thereof;
FIG. 7 is a top view thereof;
FIG. 8 is an isometric view thereof with a lid;
FIG. 9 is a top isometric view of the lid seen in FIG. 8;
FIG. 10 is a bottom isometric view thereof;
FIG. 11 is a top view thereof;
FIG. 12 is a front view thereof;
FIG. 13 is another top isometric view of a container;
FIG. 14 is a bottom isometric view thereof;
FIG. 15 is a front view thereof;
FIG. 16 is a rear view thereof;
FIG. 17 is a left side view thereof;
FIG. 18 is a right side view thereof;
FIG. 19 is a top view thereof;
FIG. 20 is an isometric view thereof with a lid;
FIG. 21 is a top isometric view of the lid seen in FIG. 20;
FIG. 22 is a bottom isometric view thereof;
FIG. 23 is a top view thereof;
FIG. 24 is a front view thereof;
FIG. 25 is another top isometric view of a container;
FIG. 26 is a bottom isometric view thereof;
FIG. 27 is a front view thereof;
FIG. 28 is a rear view thereof;
FIG. 29 is a left side view thereof;
FIG. 30 is a right side view thereof;
FIG. 31 is a top view thereof;
FIG. 32 is an isometric view thereof with a lid;
FIG. 33 is a top isometric view of the lid seen in FIG. 32;

(Continued)

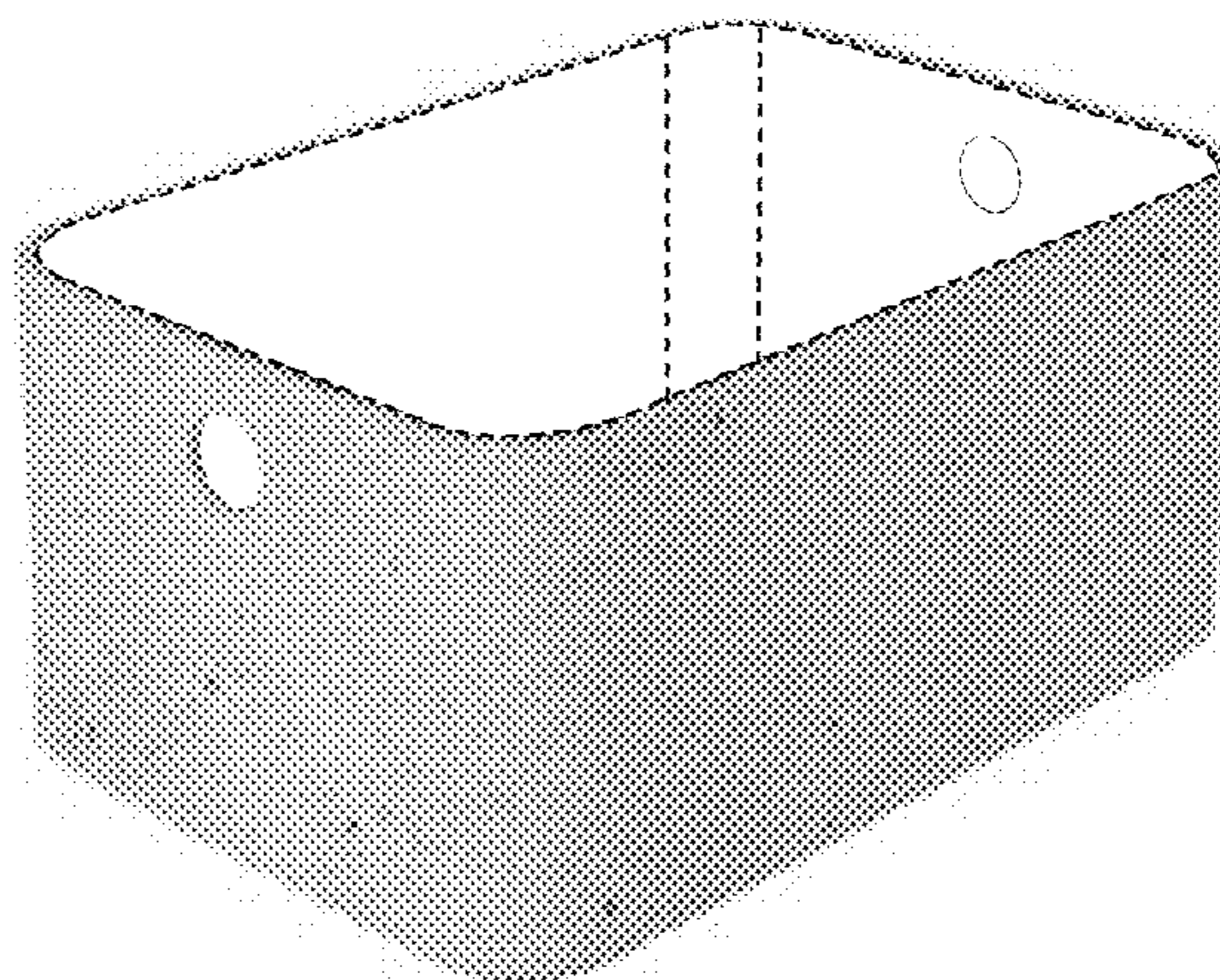
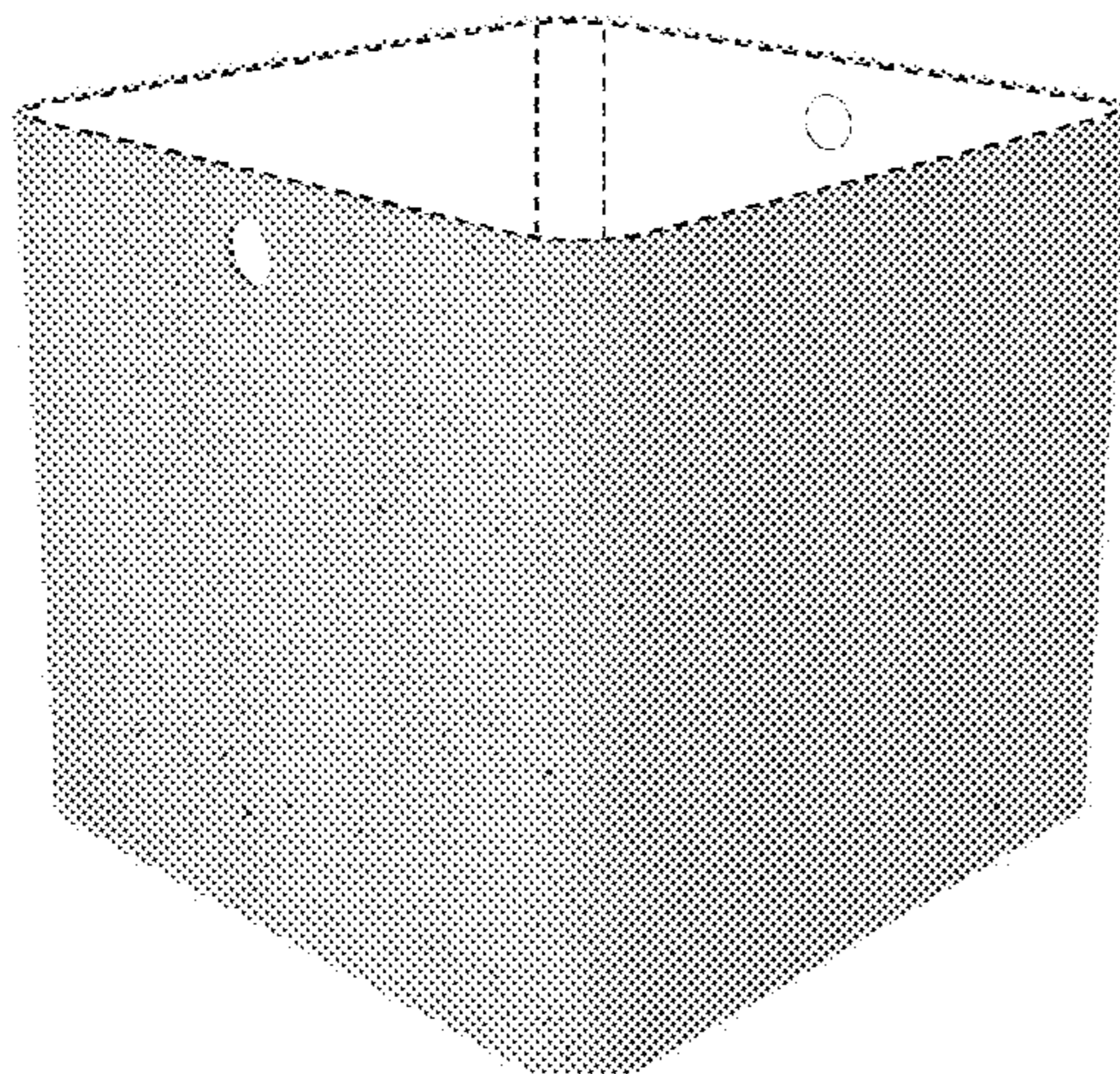

FIG. 34 is a bottom isometric view thereof;
 FIG. 35 is a top view thereof;
 FIG. 36 is a front view thereof;
 FIG. 37 is a right side view thereof;
 FIG. 38 is another top isometric view of a container;
 FIG. 39 is a bottom isometric view thereof;
 FIG. 40 is a front view thereof;
 FIG. 41 is a rear view thereof;
 FIG. 42 is a left side view thereof;
 FIG. 43 is a right side view thereof;
 FIG. 44 is a top view thereof;
 FIG. 45 is an isometric view thereof with a lid;
 FIG. 46 is a top isometric view of the lid seen in FIG. 45;
 FIG. 47 is a bottom isometric view thereof;
 FIG. 48 is a top view thereof;
 FIG. 49 is a front view thereof;
 FIG. 50 is a right side view thereof;
 FIG. 51 is another top isometric view of a container;
 FIG. 52 is a bottom isometric view thereof;
 FIG. 53 is a front view thereof;
 FIG. 54 is a rear view thereof;
 FIG. 55 is a left side view thereof;
 FIG. 56 is a right side view thereof;
 FIG. 57 is a top view thereof;
 FIG. 58 is an isometric view thereof with a lid;
 FIG. 59 is a top isometric view of the lid seen in FIG. 58;
 FIG. 60 is a bottom isometric view thereof;
 FIG. 61 is a top view thereof;
 FIG. 62 is a front view thereof; and,
 FIG. 63 is a right side view thereof.

The broken lines and the surfaces within are shown for the purpose of illustrating parts of the article that form no part of the claim.

1 Claim, 30 Drawing Sheets

(58) **Field of Classification Search**

USPC D9/423, 424, 430–432, 433, 456, 734,
 D9/736, 500, 501, 503, 504
 CPC .. B65D 43/162; B65D 81/02; B65D 81/3813;
 B65D 5/65; B65D 5/66; B65D 5/468;
 C08L 23/12; B29C 45/0001; B29C
 45/372

See application file for complete search history.

(56)

References Cited

U.S. PATENT DOCUMENTS

D697,400	S	*	1/2014	Bragalone	D9/416
D751,863	S	*	3/2016	Eyal	D7/514
D778,156	S	*	2/2017	Follett	D9/432
D782,298	S	*	3/2017	de Baschmakoff	D9/432
D799,137	S	*	10/2017	Bowen	D34/7
D799,149	S	*	10/2017	Chafetz	D99/28
D805,352	S	*	12/2017	Thuma	D7/523
9,930,979	B2	*	4/2018	Miller	B65D 31/10
D816,995	S	*	5/2018	Fleming	D3/294
D817,112	S	*	5/2018	Jarvis	D7/629
D817,116	S	*	5/2018	Evans	D7/629
D822,762	S	*	7/2018	Gwartzman	D19/104
D823,062	S	*	7/2018	Goodwin	D7/511
D825,335	S	*	8/2018	Buck	D9/500
D825,551	S	*	8/2018	Akana	D14/314
D825,923	S	*	8/2018	Suomela	D3/304
D826,005	S	*	8/2018	Walters Pennington	D7/629
D829,554	S	*	10/2018	Liston	D9/529
D831,479	S	*	10/2018	Lylyk	D9/432
D834,314	S	*	11/2018	Nicoline	D3/304
D834,377	S	*	11/2018	Zoske	D7/629
D841,195	S	*	2/2019	Hollingsworth	D26/9
D845,756	S	*	4/2019	Pereira Da Silva	D9/428
D847,645	S	*	5/2019	Lee	D9/504
D852,635	S	*	7/2019	Dammers	D9/566
D853,057	S	*	7/2019	Itzhak-Sigron	D30/160
D856,747	S	*	8/2019	Weernink	D7/391
D861,476	S	*	10/2019	Rogers	D9/418
D878,002	S	*	3/2020	McKay	D99/5
D878,047	S	*	3/2020	Shafir	D3/282
D878,051	S	*	3/2020	Kraemer	D3/307
D879,564	S	*	3/2020	Adams, Jr.	D7/612
D902,991	S	*	11/2020	Tivnon	D18/50
2020/0339333	A1	*	10/2020	Numminen	B65D 81/03

OTHER PUBLICATIONS

Curver Beton: Announced [May 28, 2019, online]. Site Visited [Jan. 28, 2021, online]. Available from Internet URL: <https://www.youtube.com/watch?v=kTaC1HD5Nzw> (Year: 2019).*

Curver Set of 3 Beton Boxes: Announced [Jul. 5, 2019, online]. Site Visited [Jan. 28, 2021, online]. Available from Internet URL: <https://www.amazon.com/Keter-Pack-Beton-Boxes-Small/dp/B07S5VB7XS> (Year: 2019).*

BatiSelf Beton <https://www.batiself.lu/shop/outillage/rangement-nettoyage/coffre-boite/boite-de-rangement-aspect-beton/> Aug. 2019 (Year: 2019).*

Curver containers https://www.curver.com/cur/catalog_category/storage/ Dec. 2019 (Year: 2019).*

Easy Furniture Hack How to Make a LEGO Inspired Wardrobe • Grillo Designs <https://grillo-designs.com/furniture-hack-lego-inspired-wardrobe/> Posted Sep. 15, 2019 (Year: 2019).*

* cited by examiner

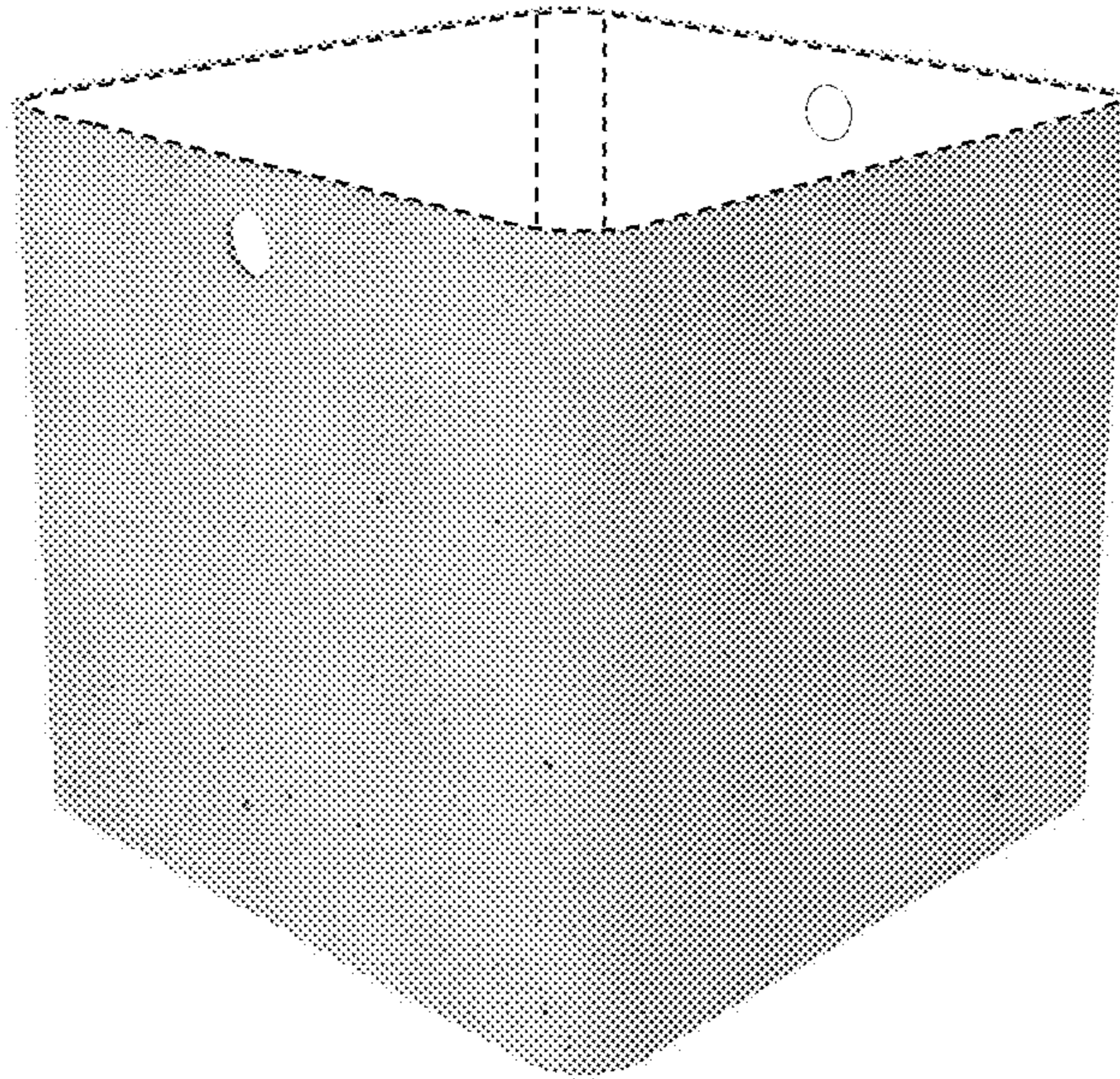

FIG. 1

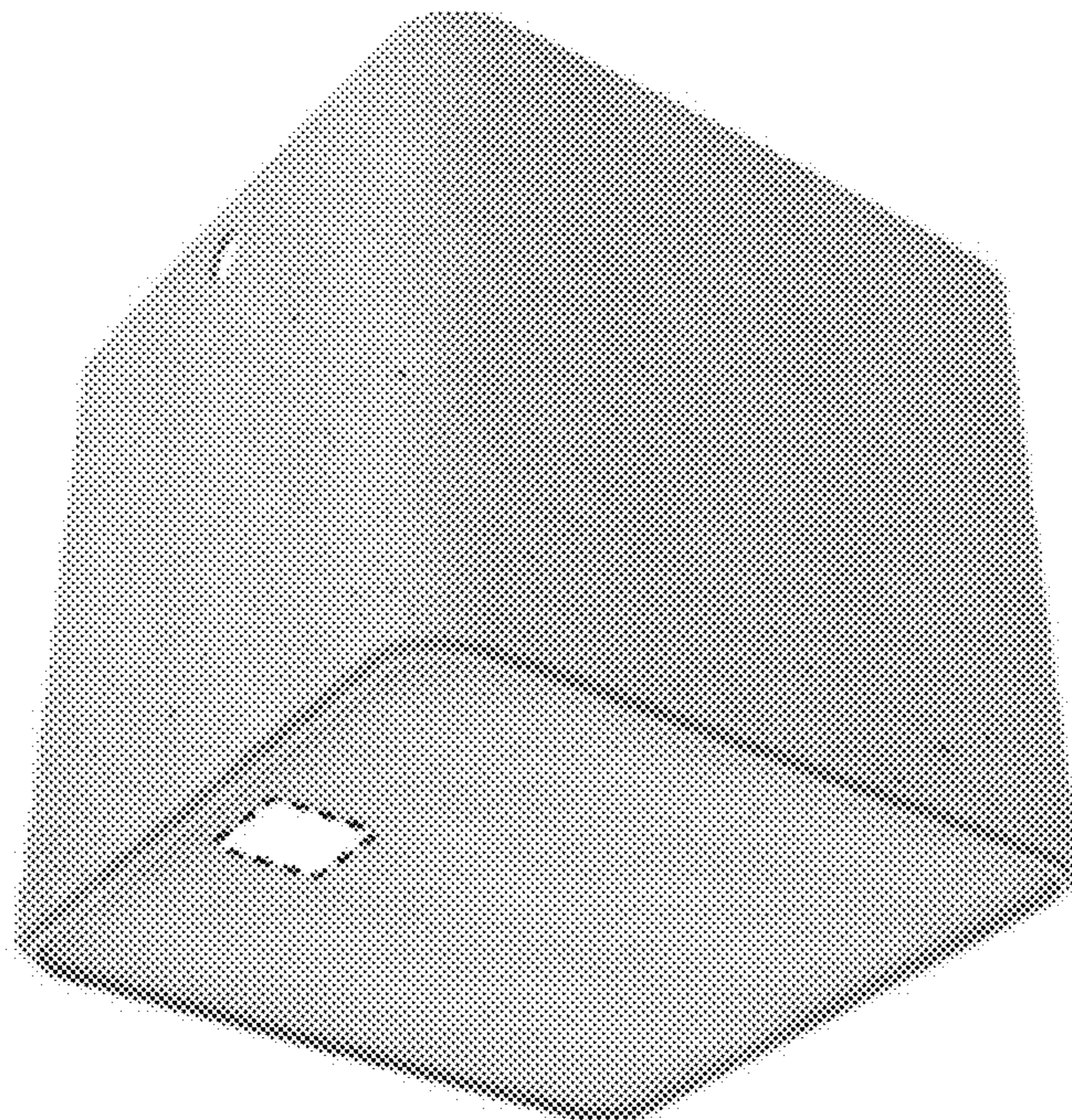

FIG. 2

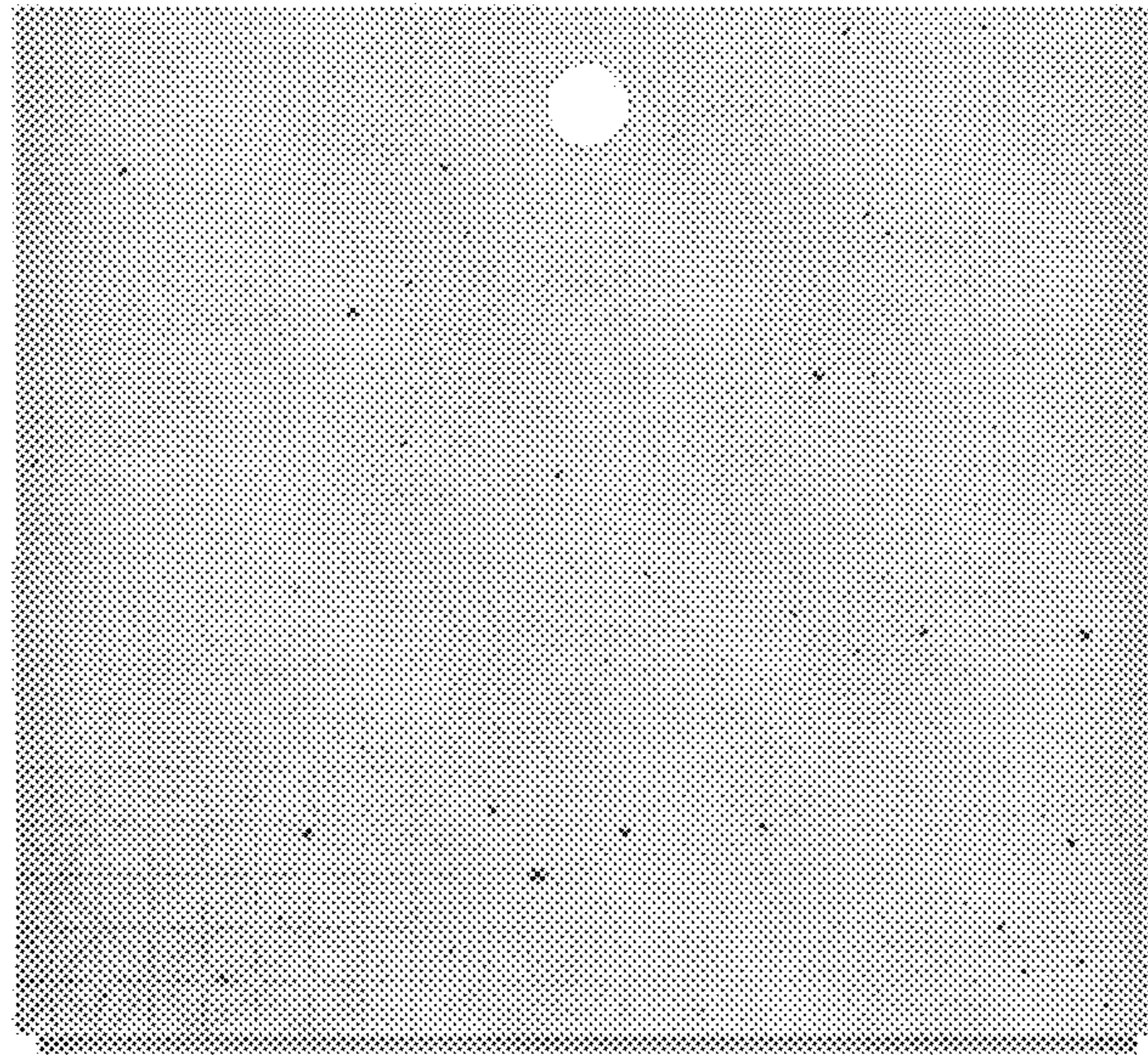

FIG. 3

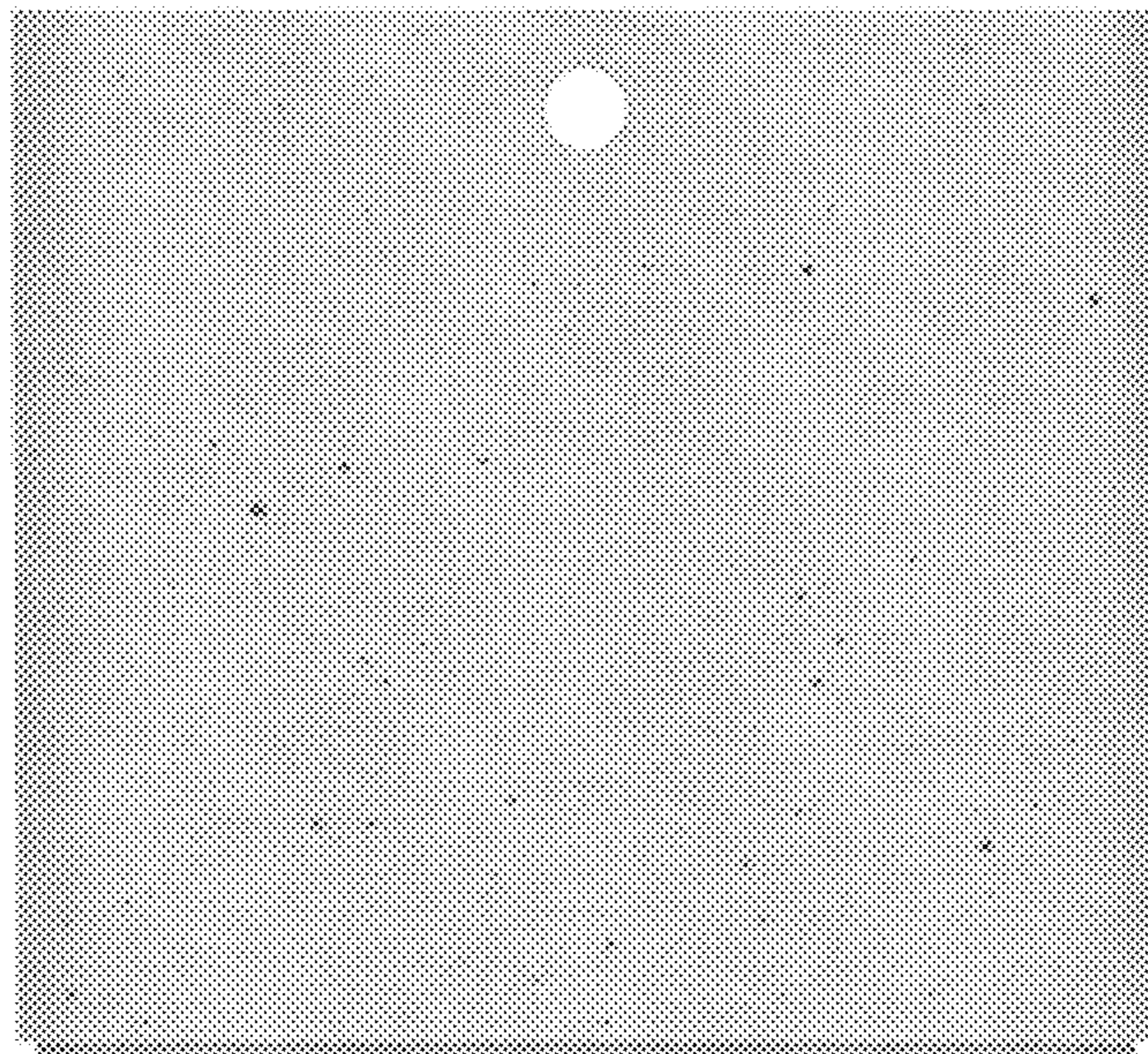

FIG. 4

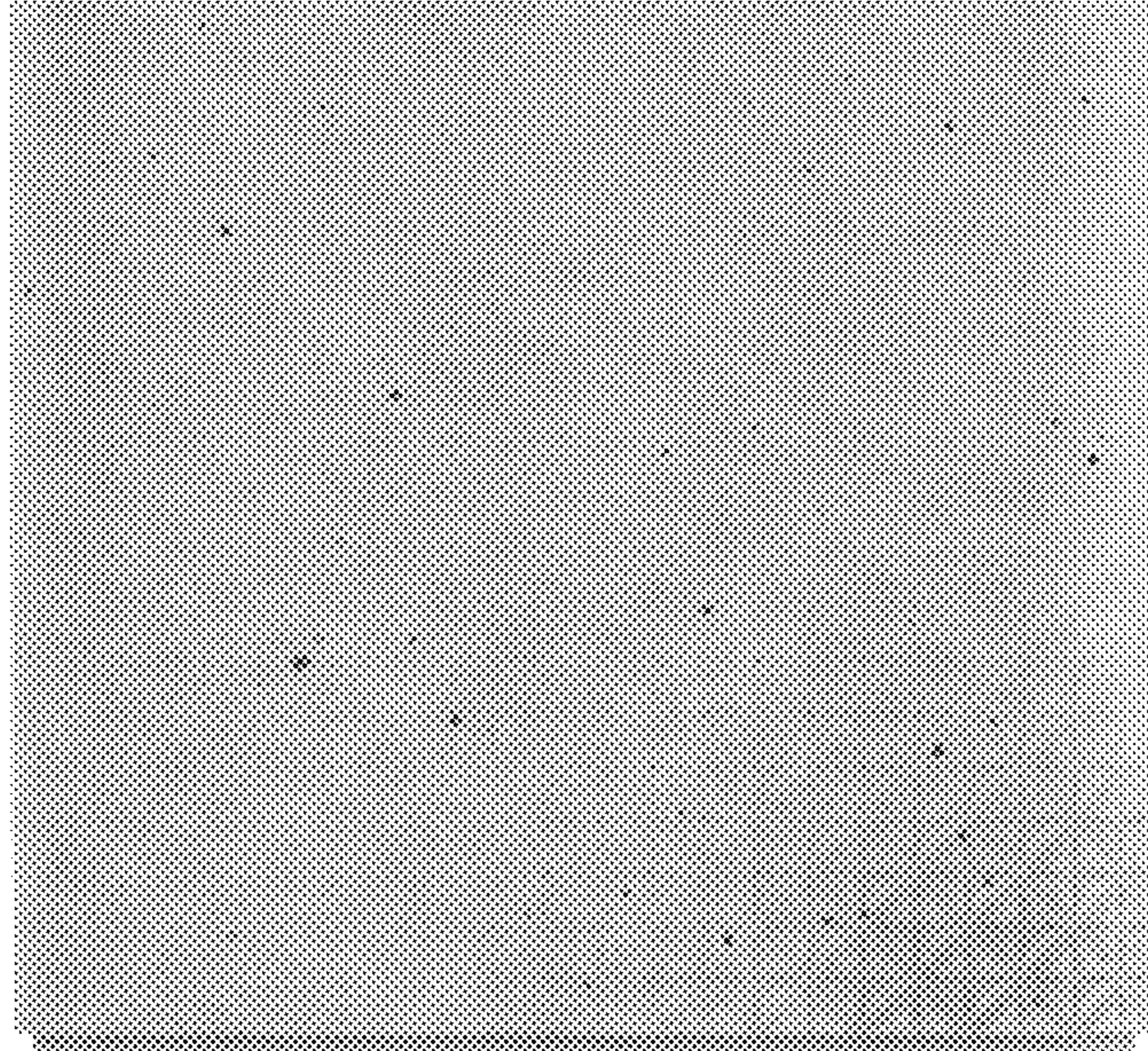

FIG. 5

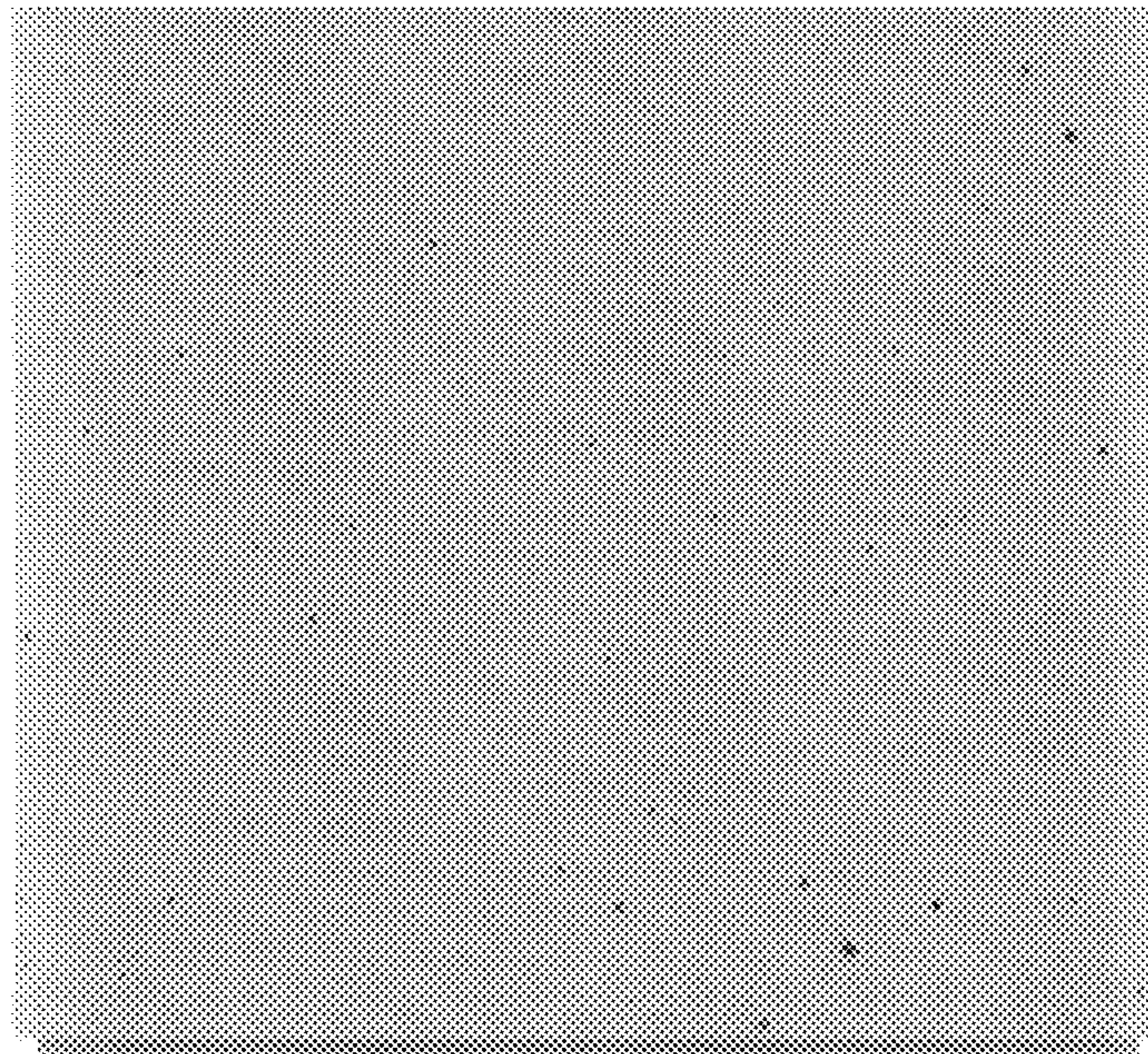

FIG. 6

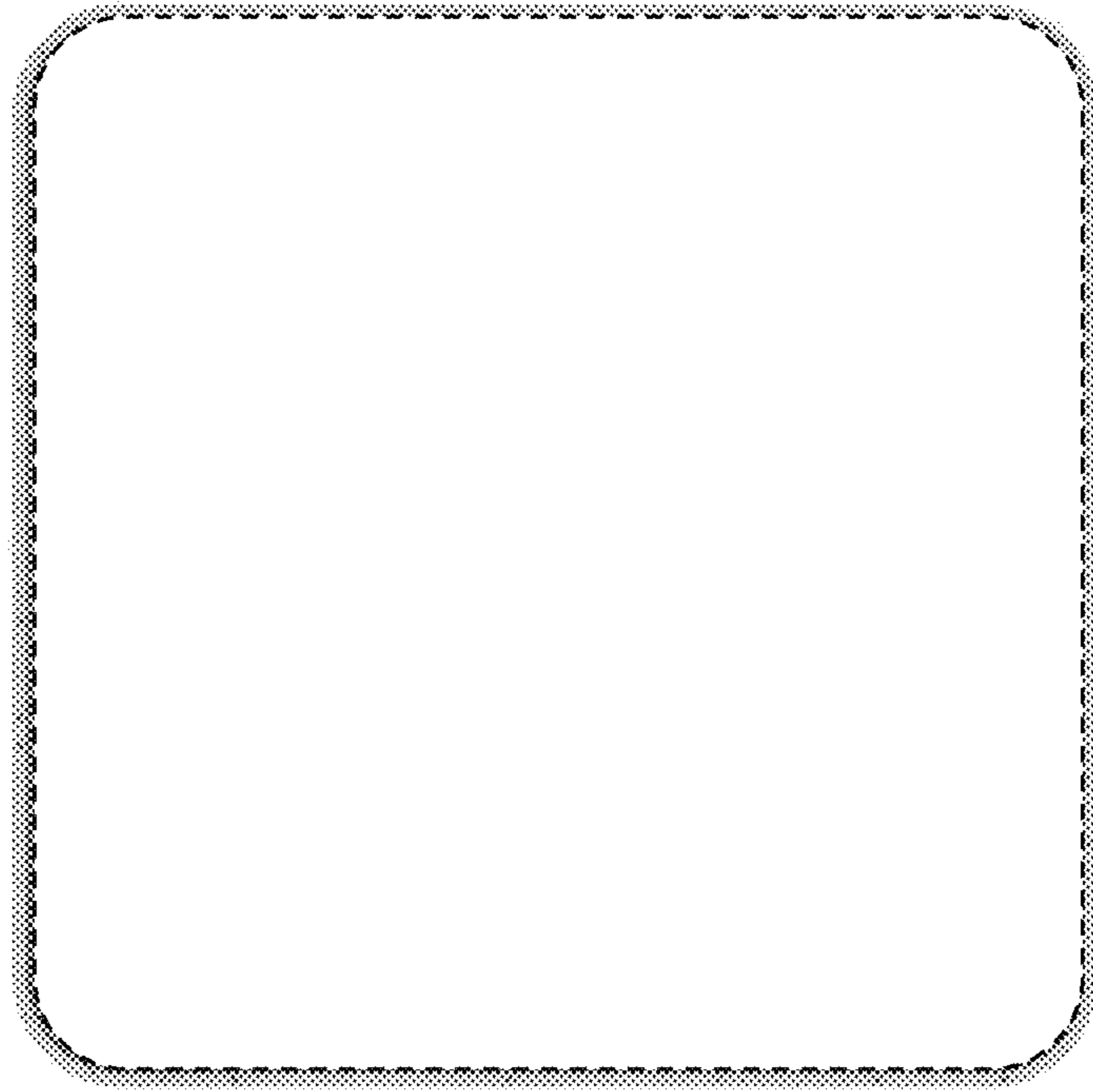

FIG. 7

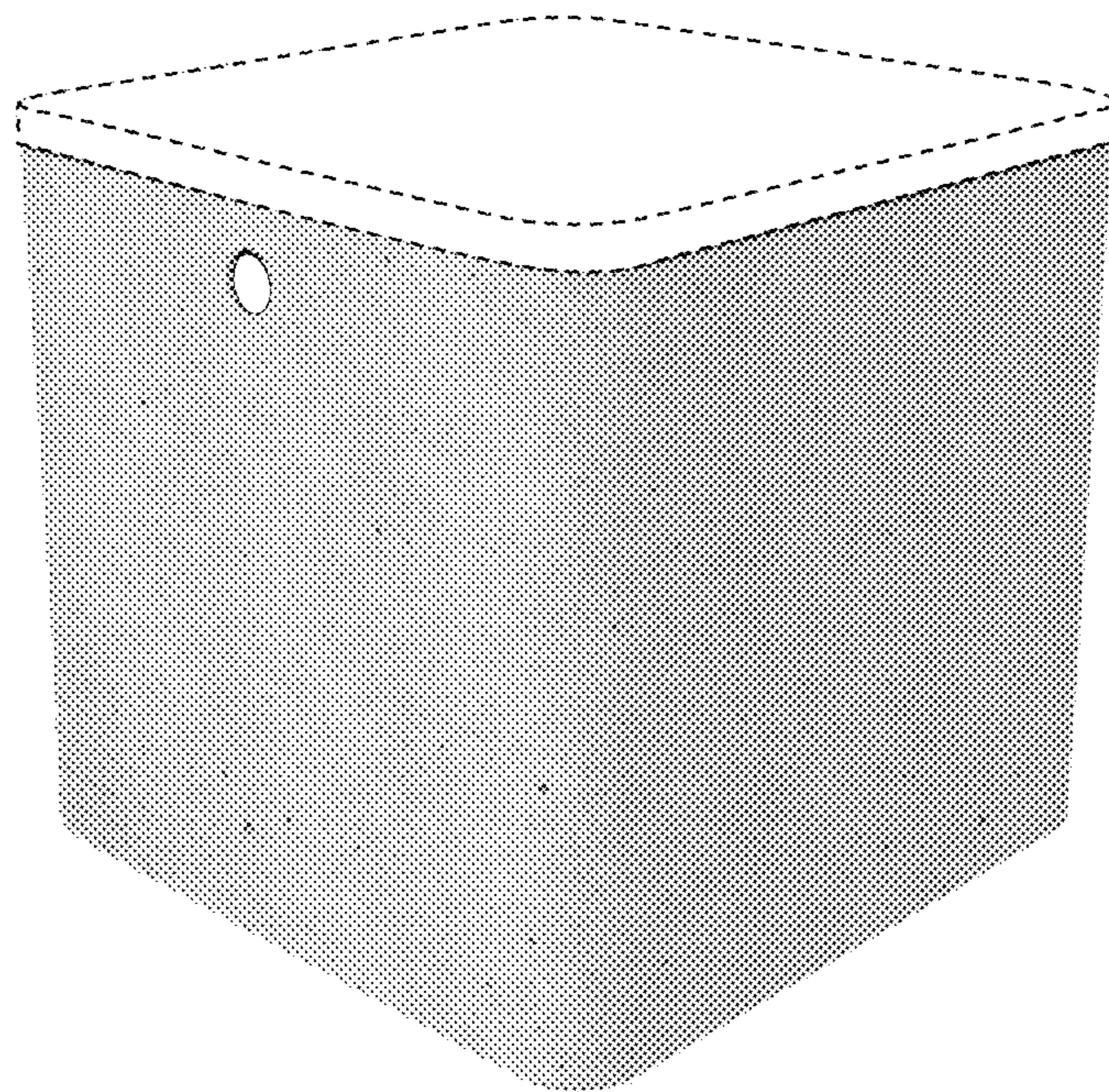

FIG. 8

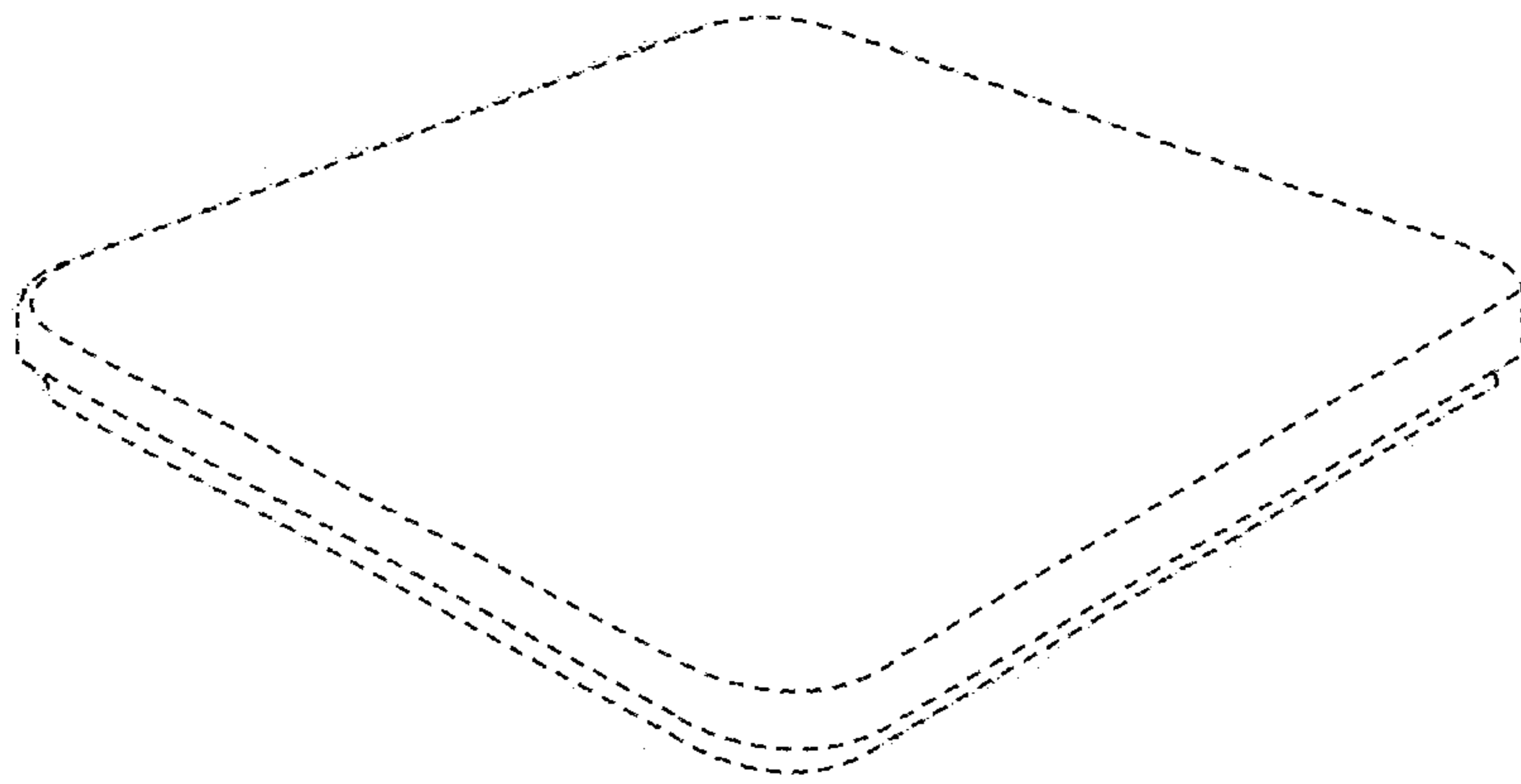

FIG. 9

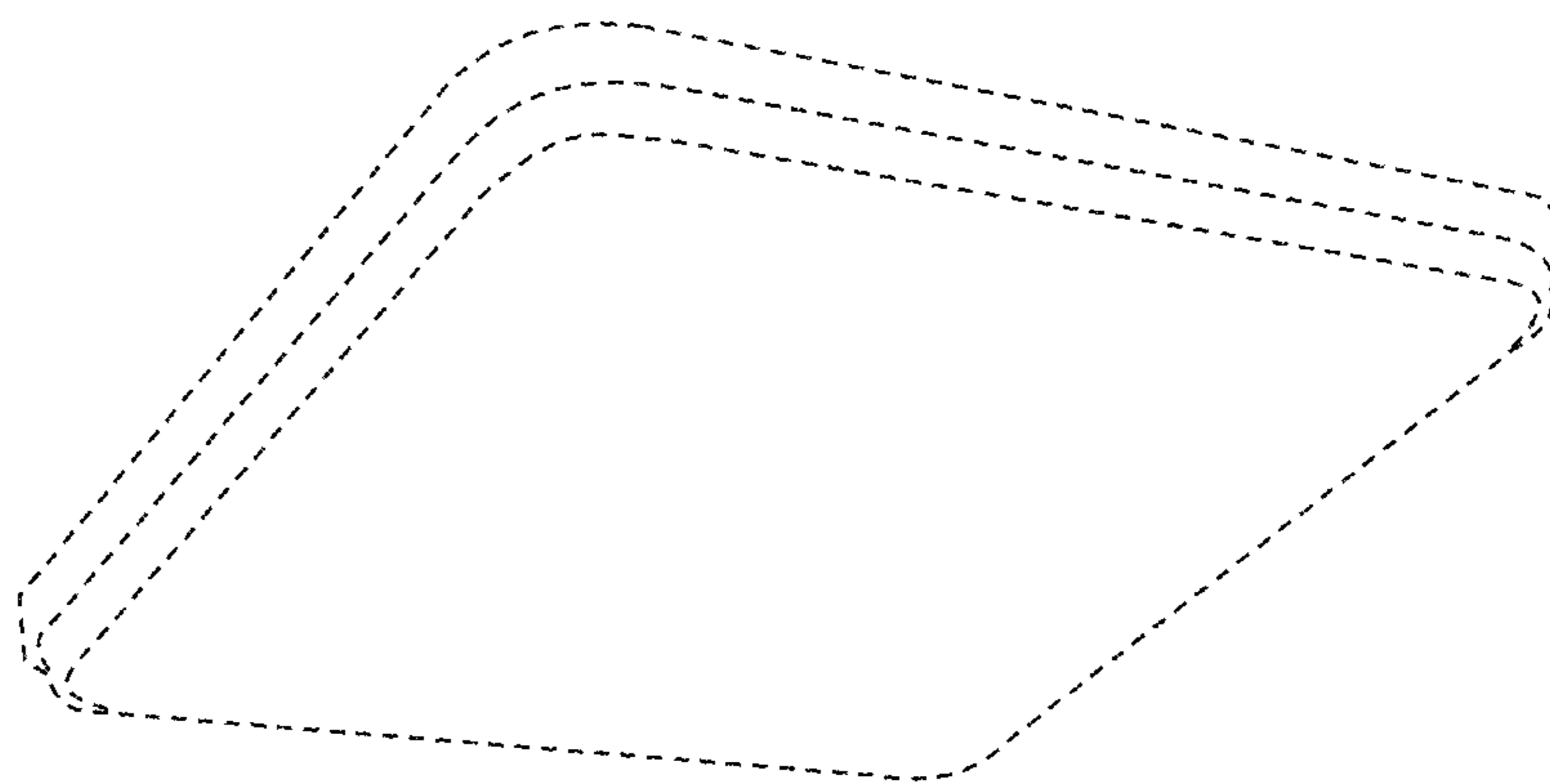

FIG. 10

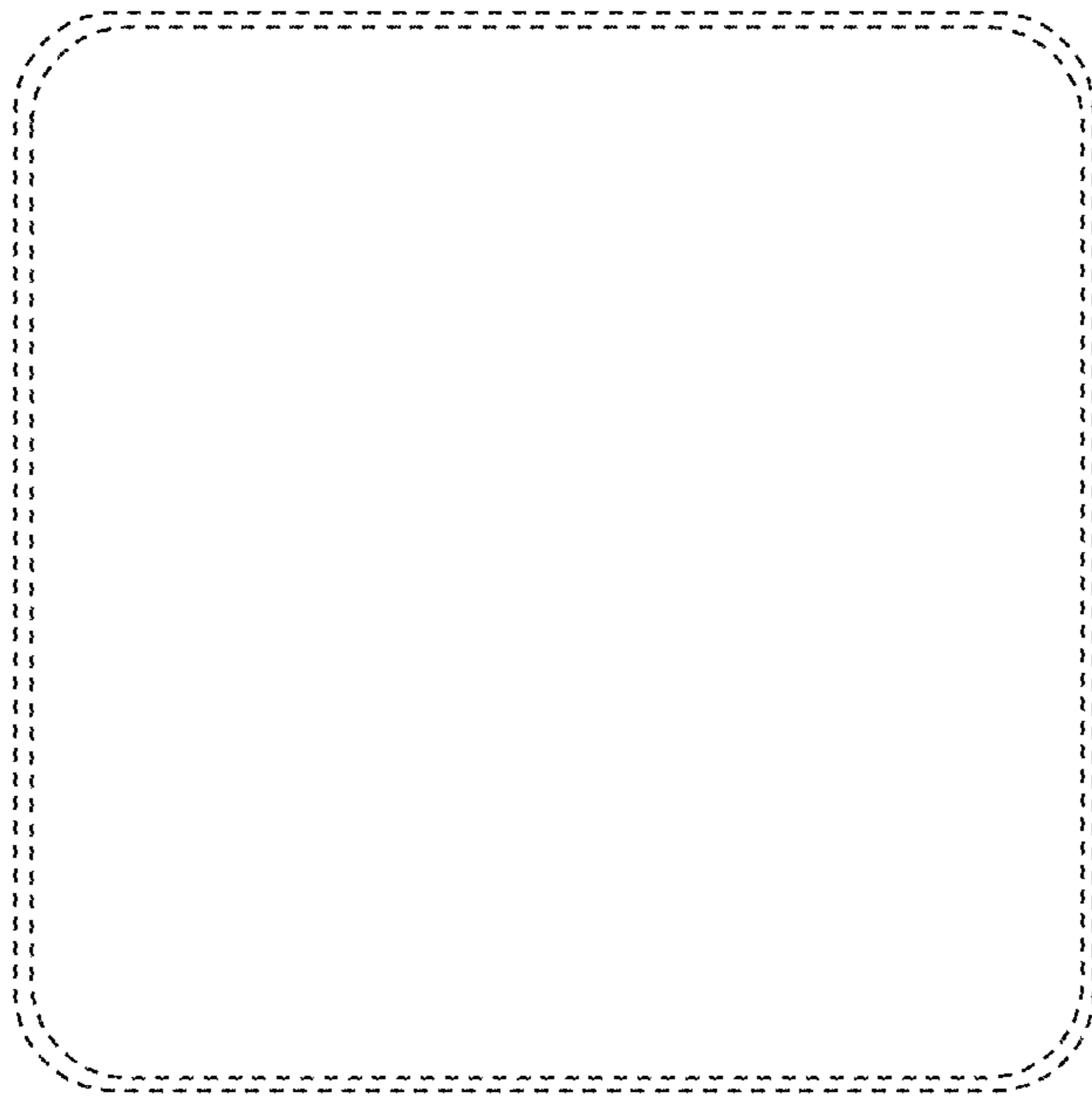

FIG. 11

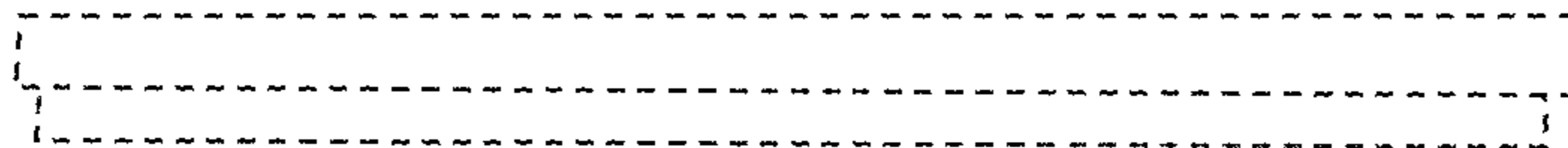

FIG. 12

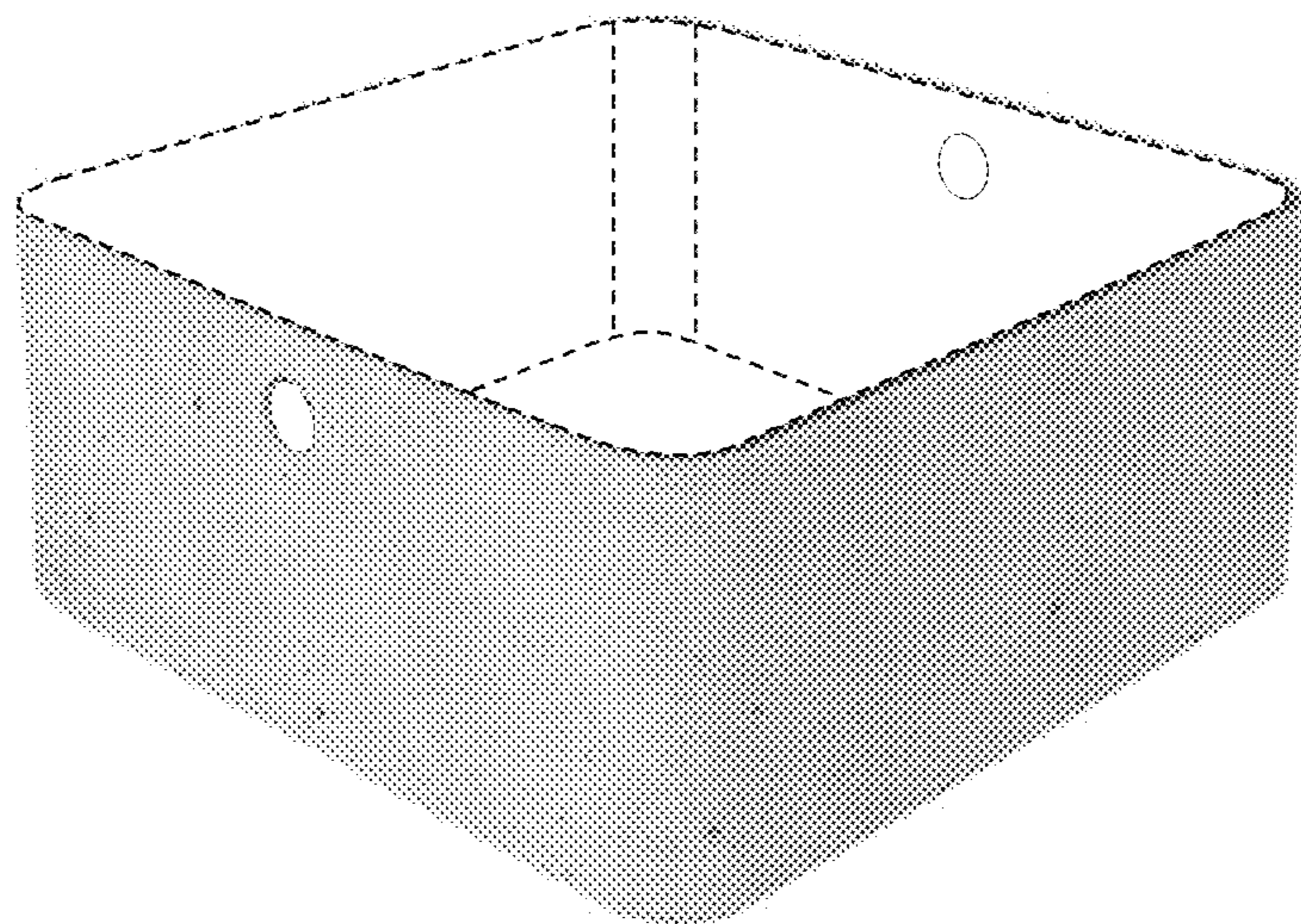

FIG. 13

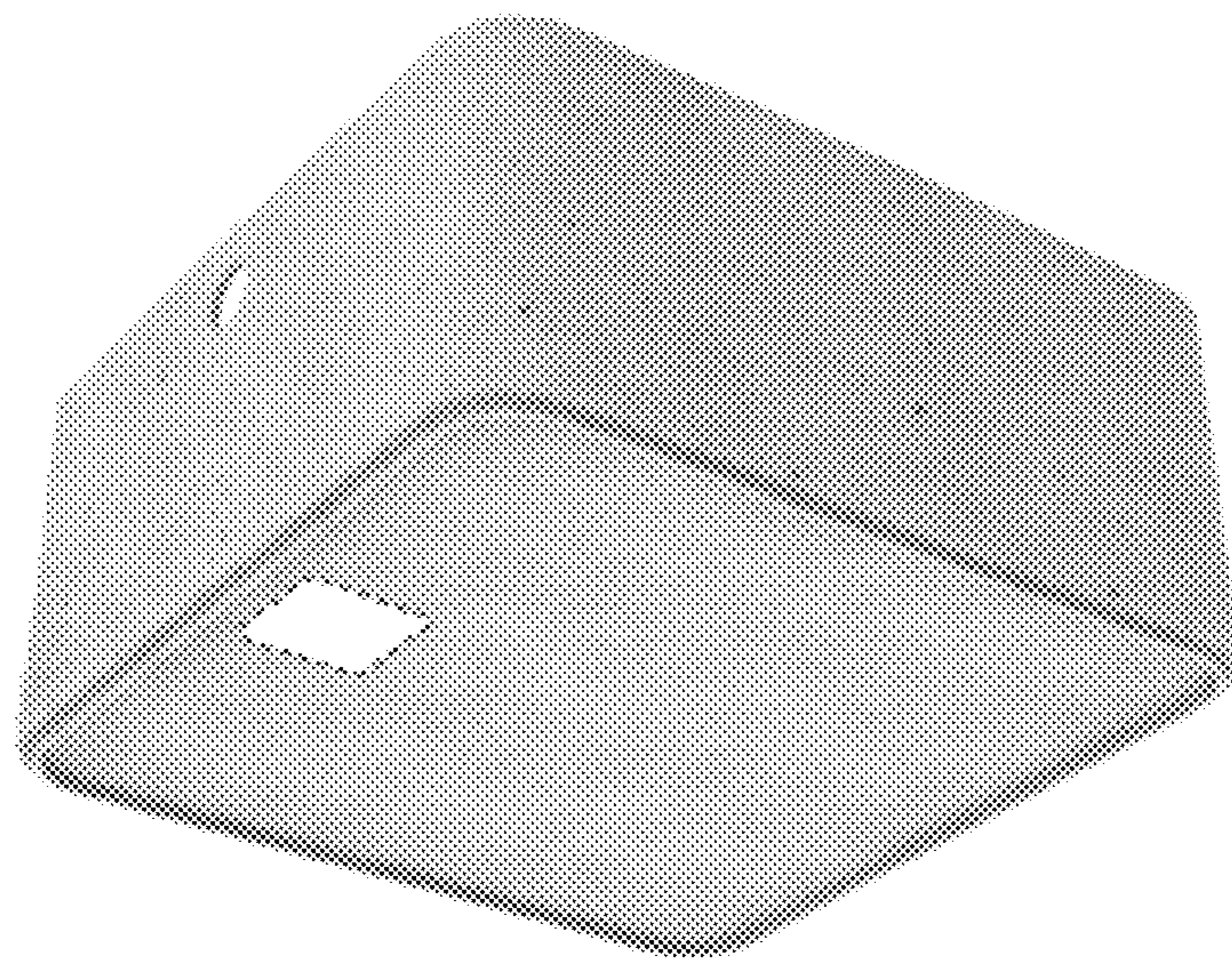

FIG. 14

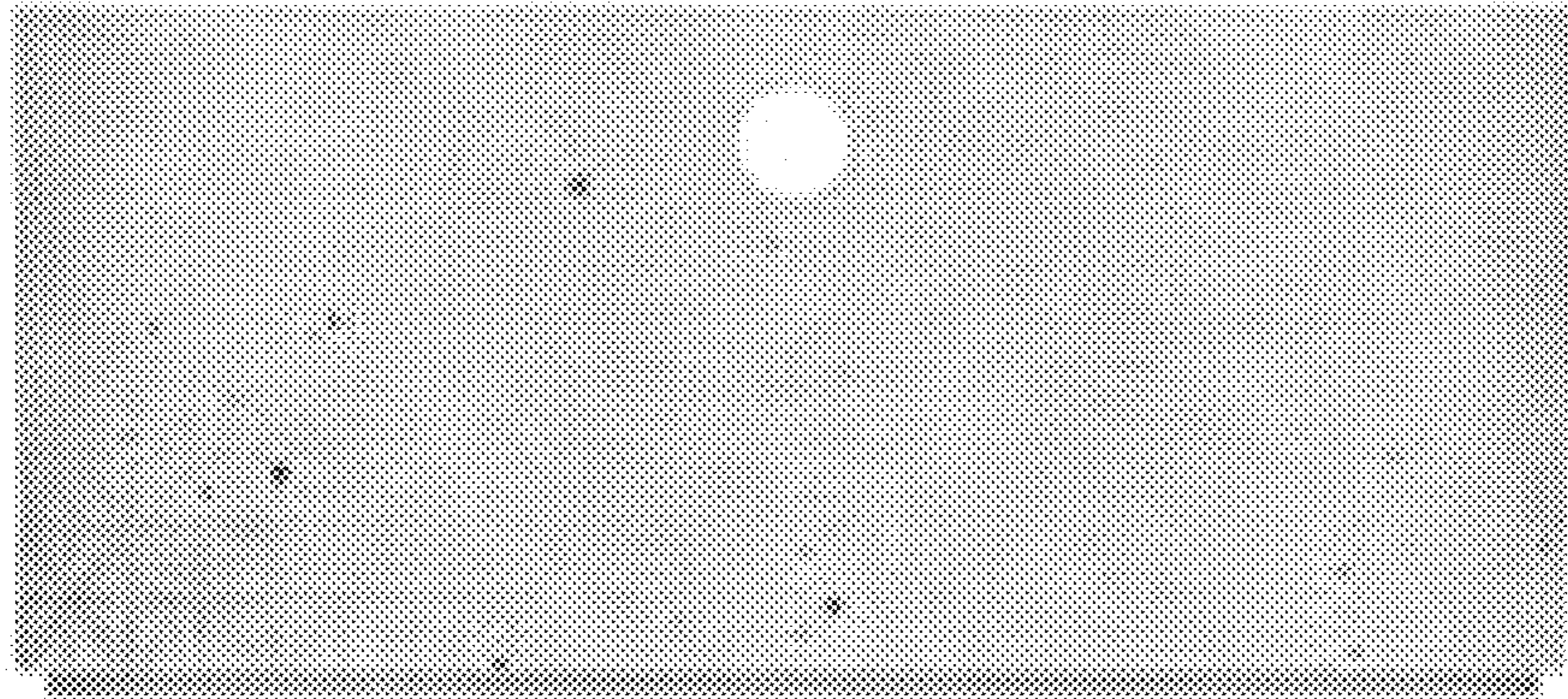

FIG. 15

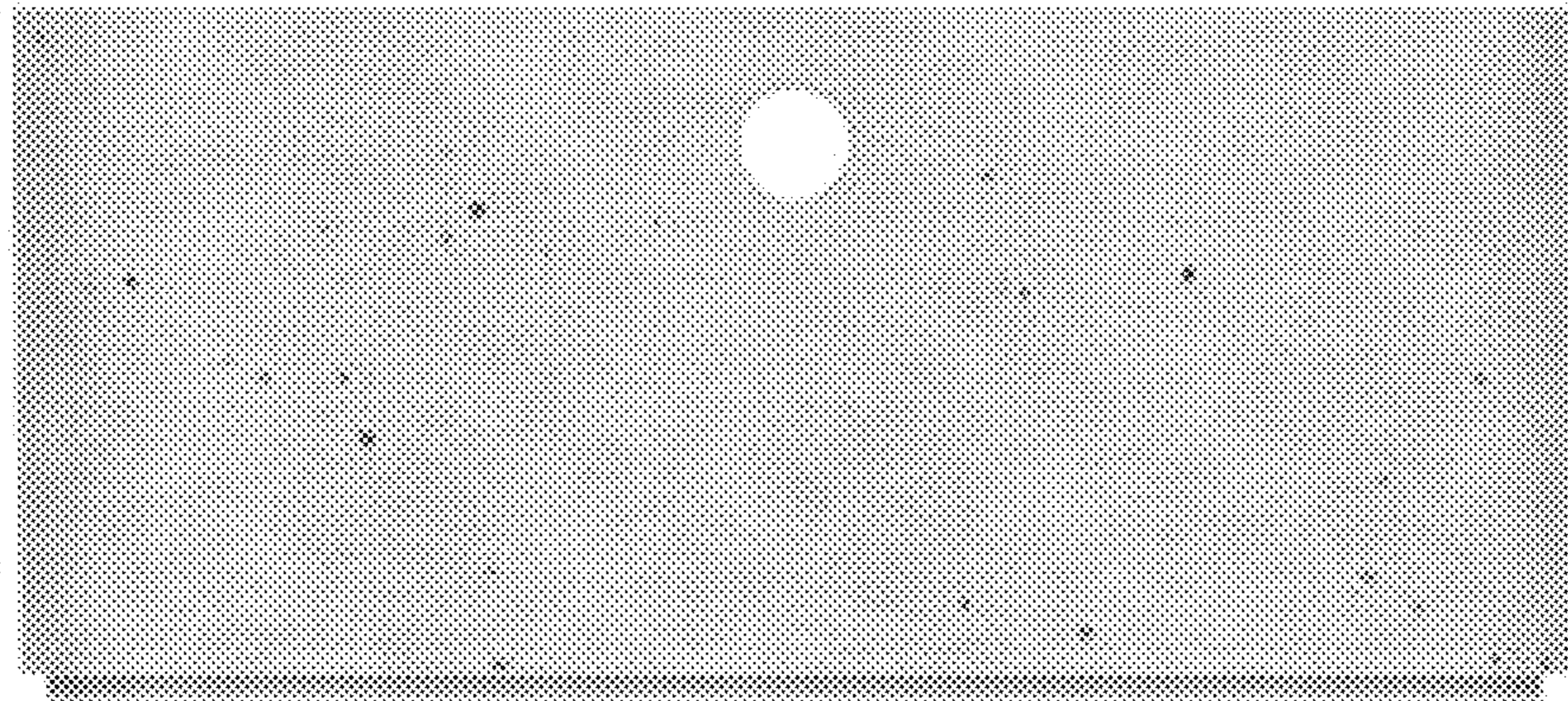

FIG. 16

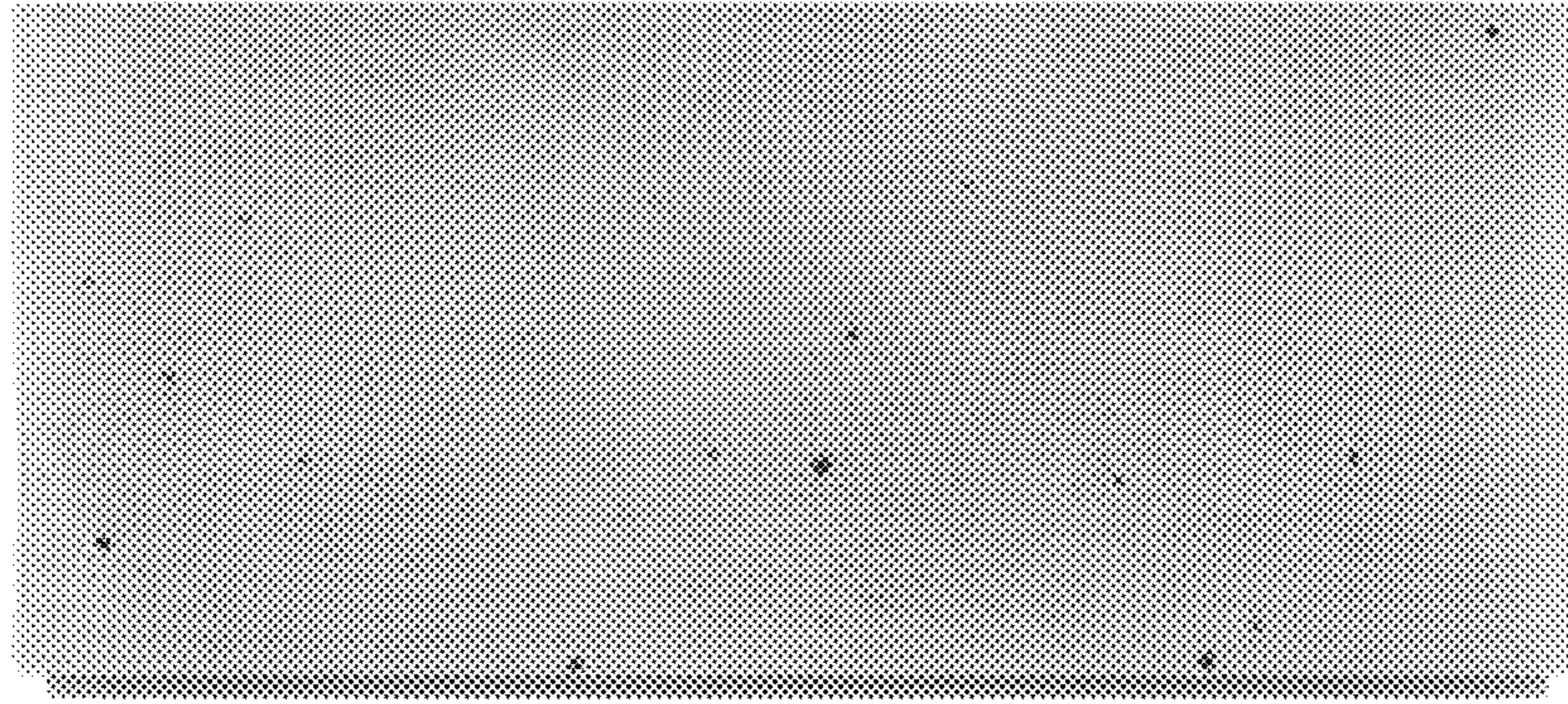

FIG. 17

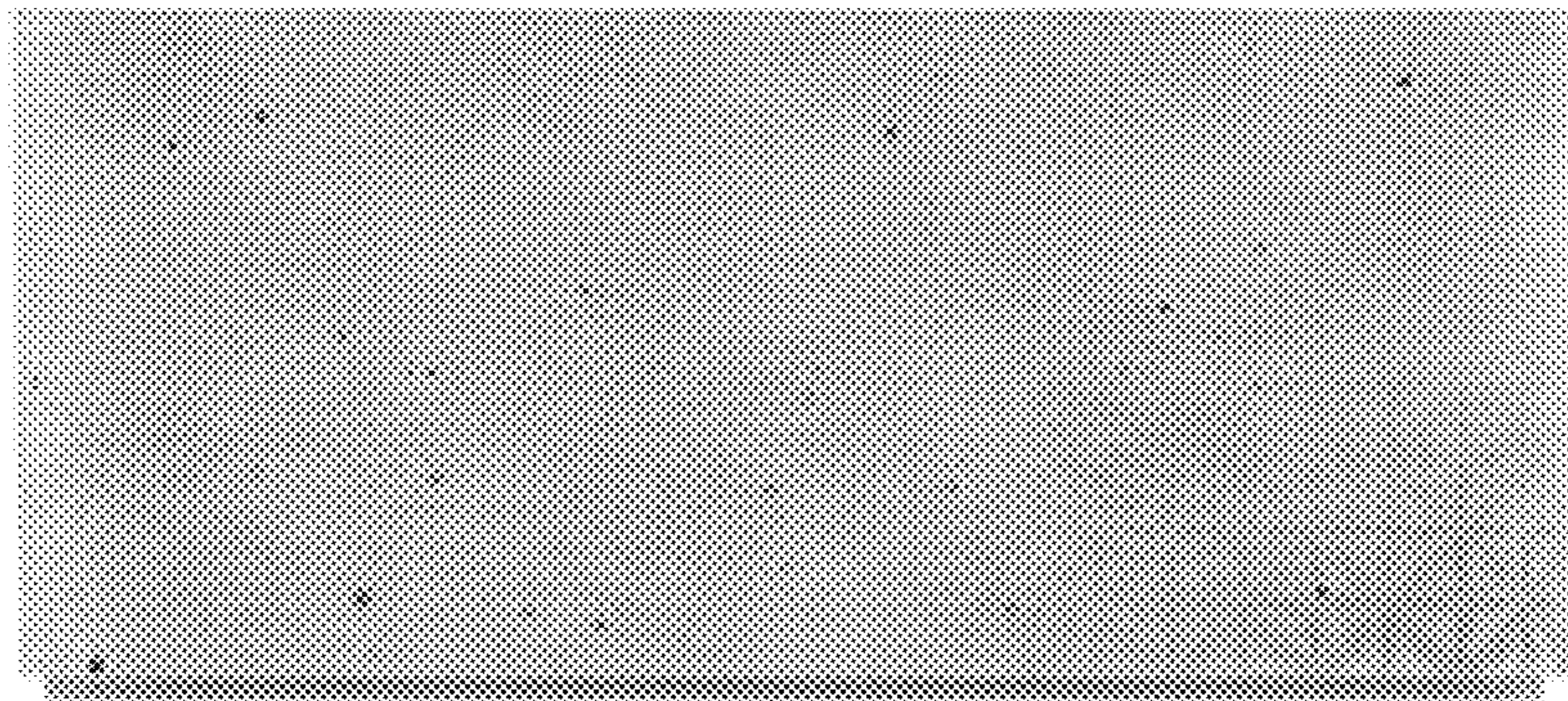

FIG. 18

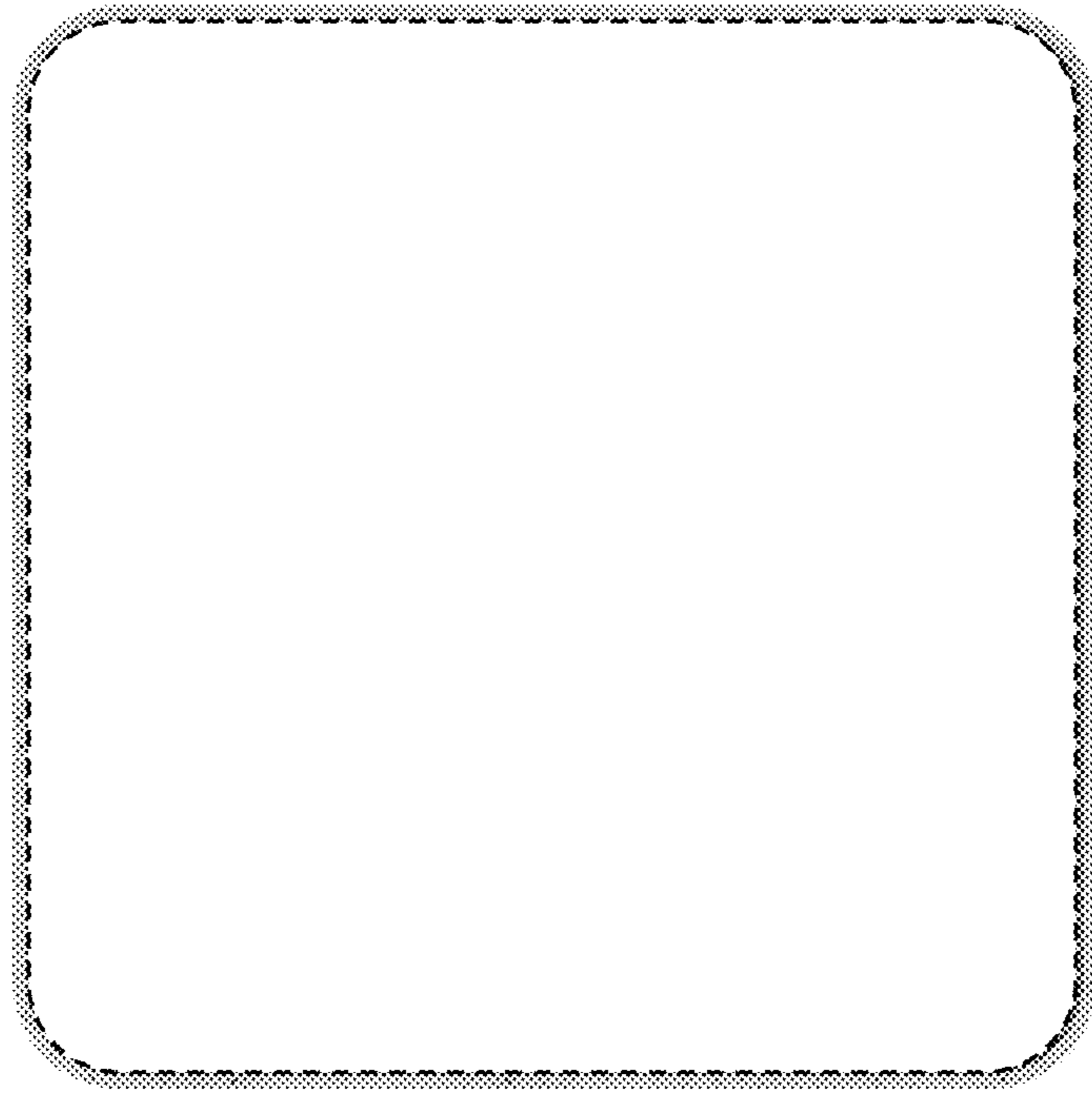

FIG. 19

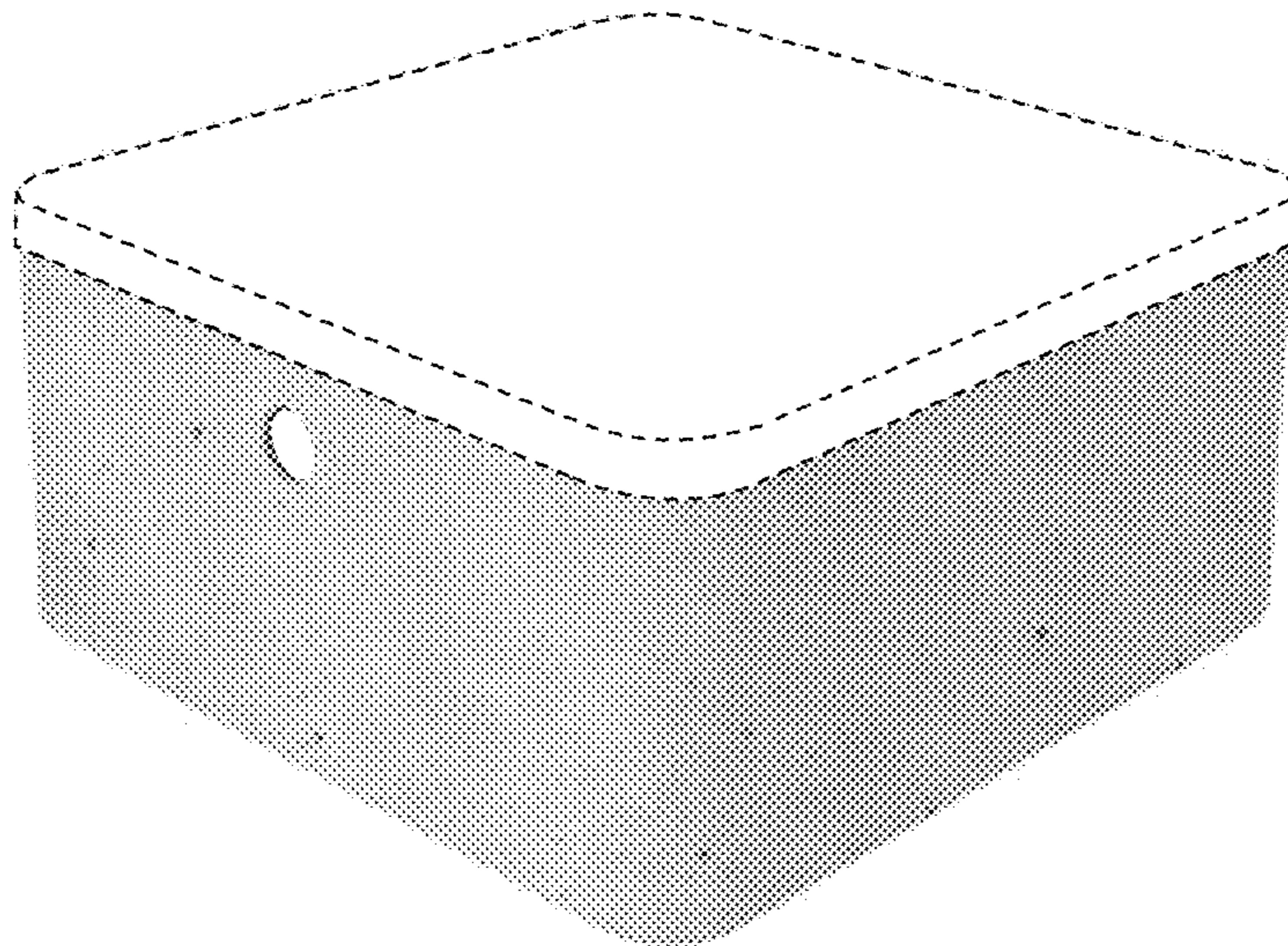

FIG. 20

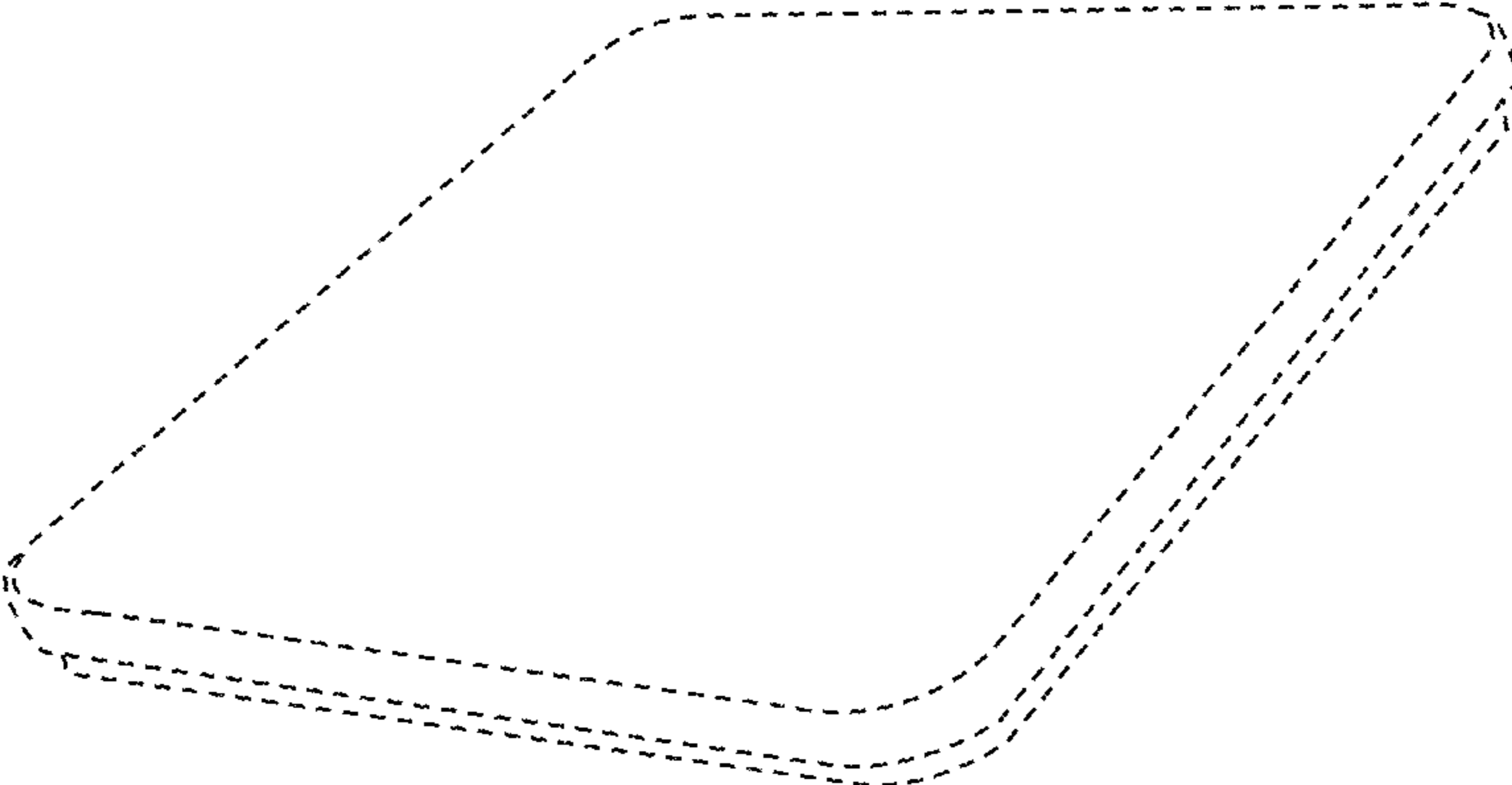

FIG. 21

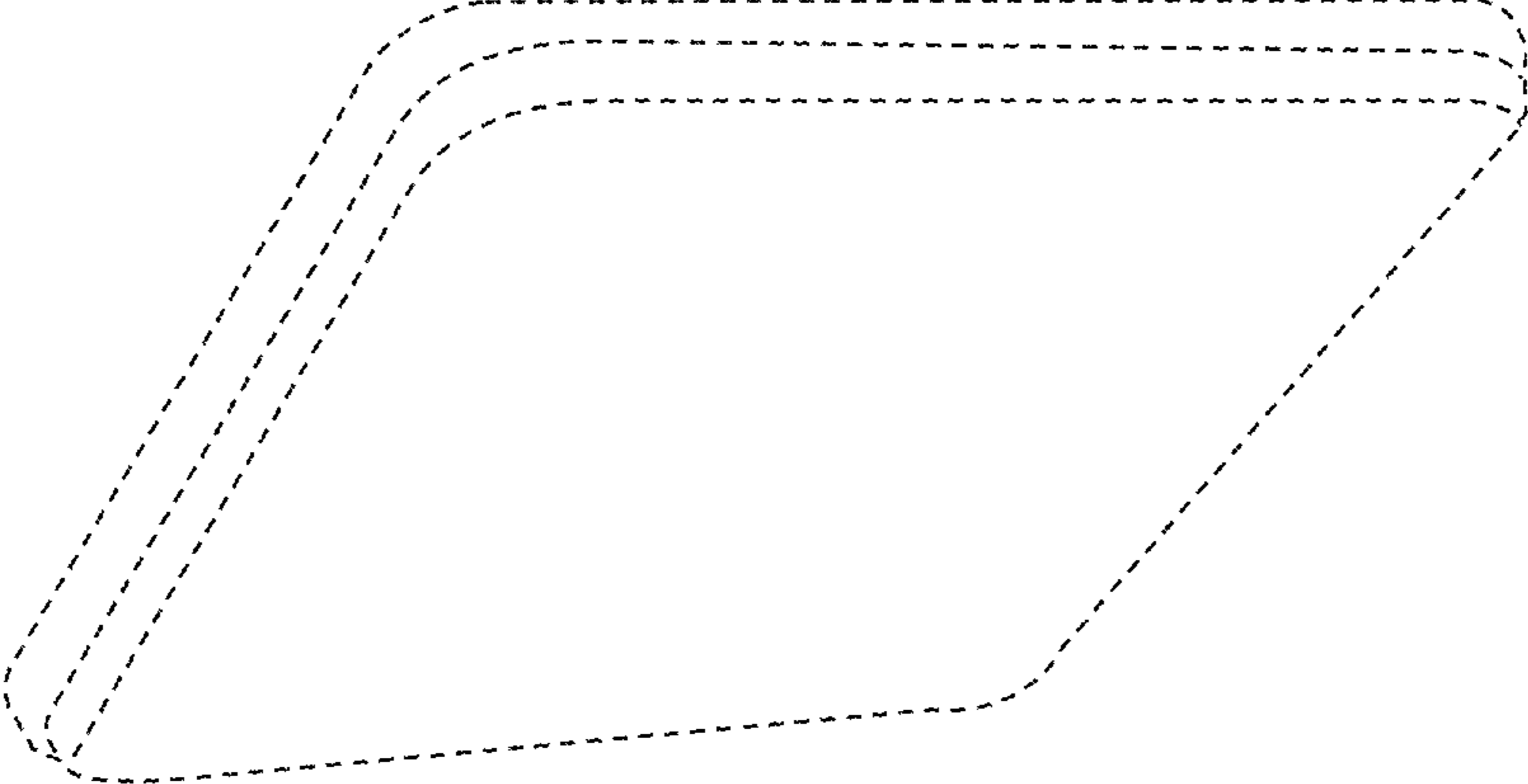

FIG. 22

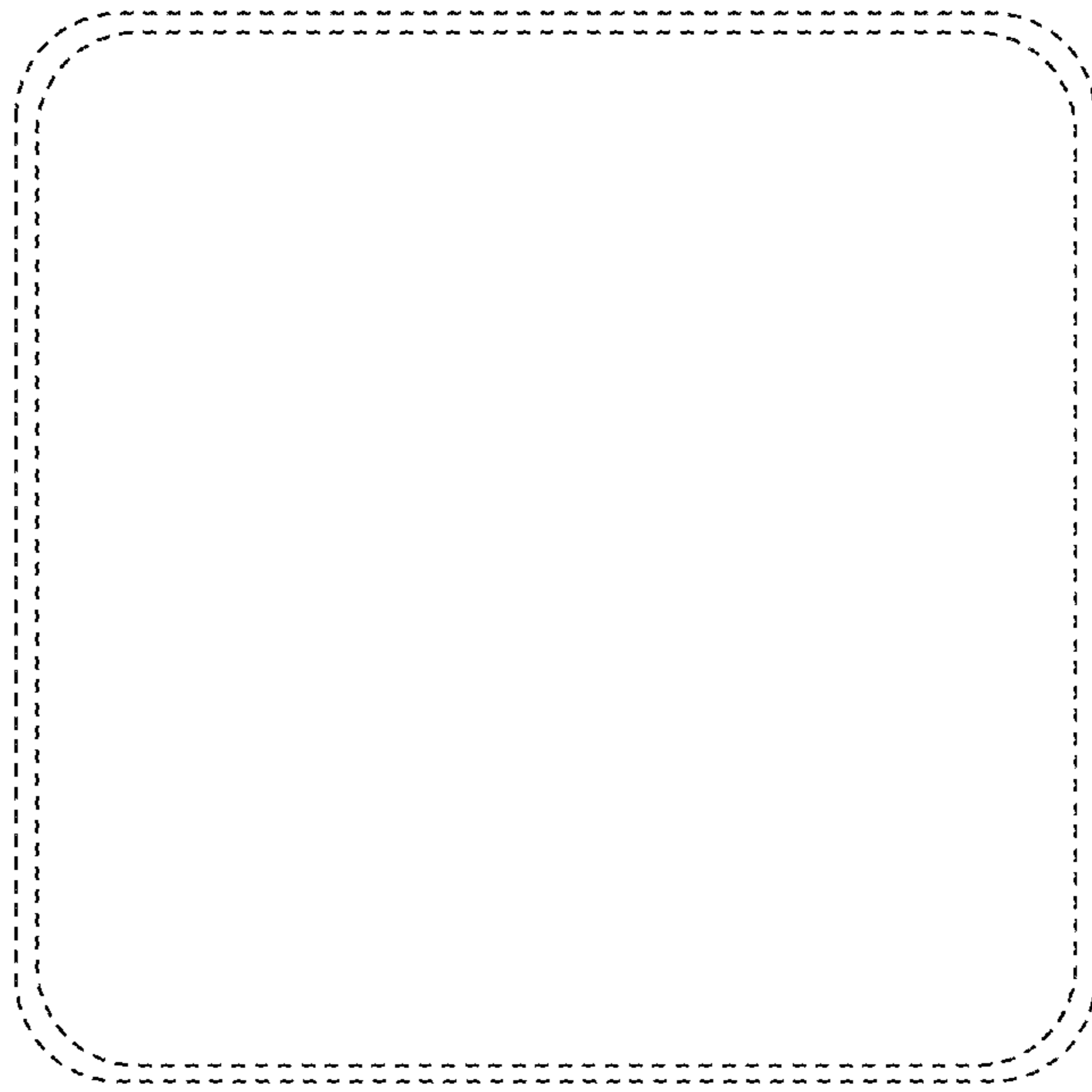

FIG. 23



FIG. 24

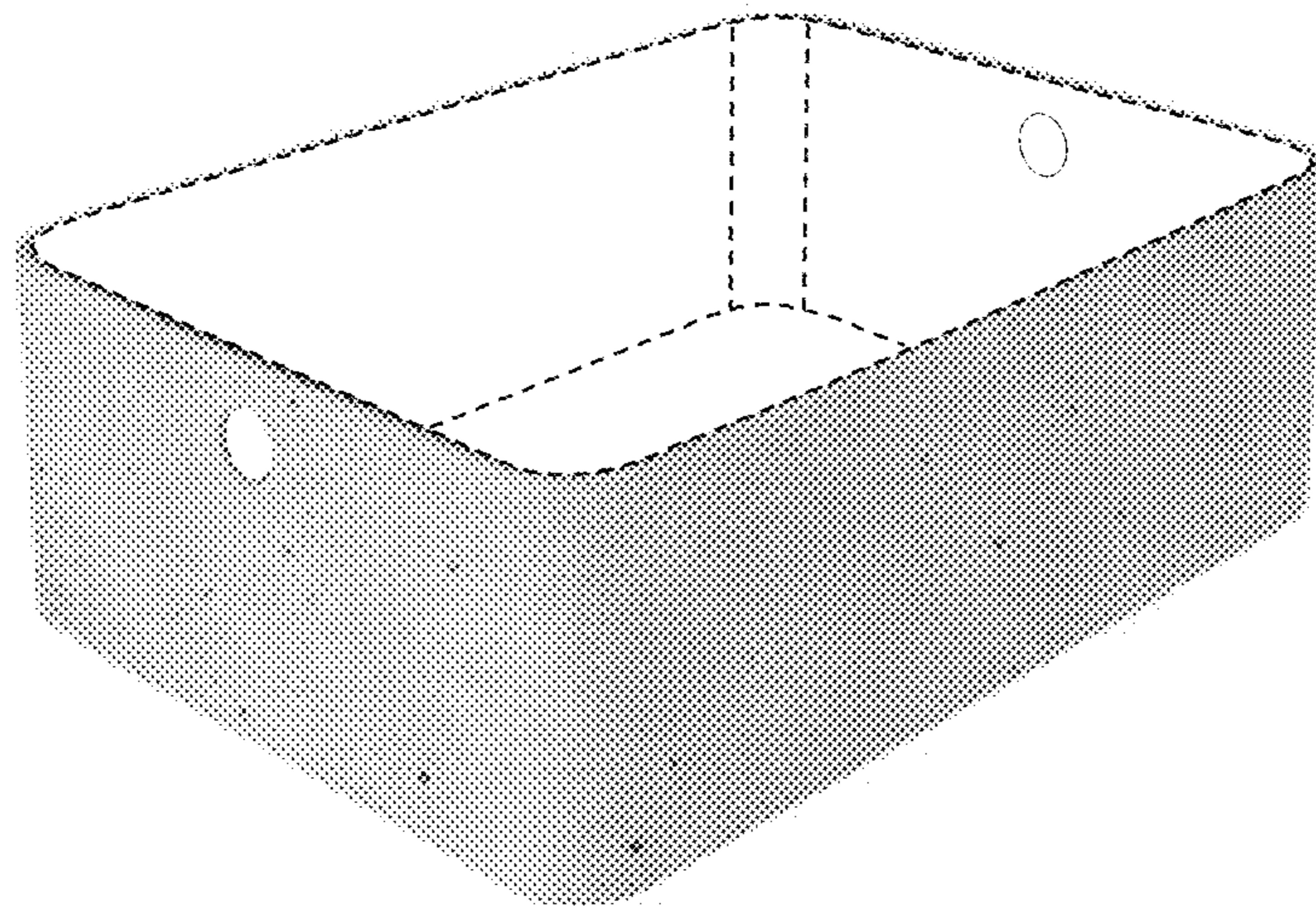

FIG. 25

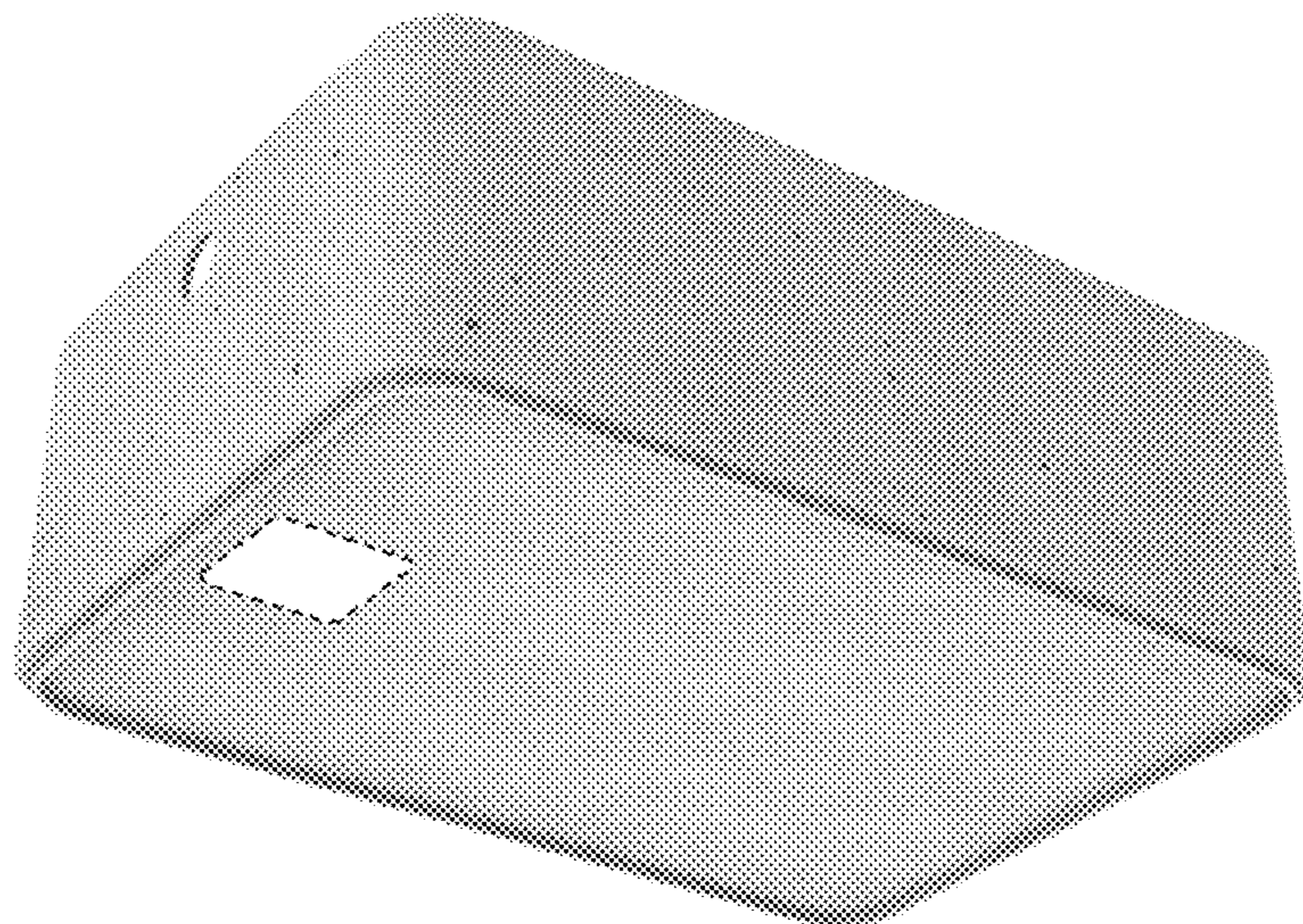

FIG. 26

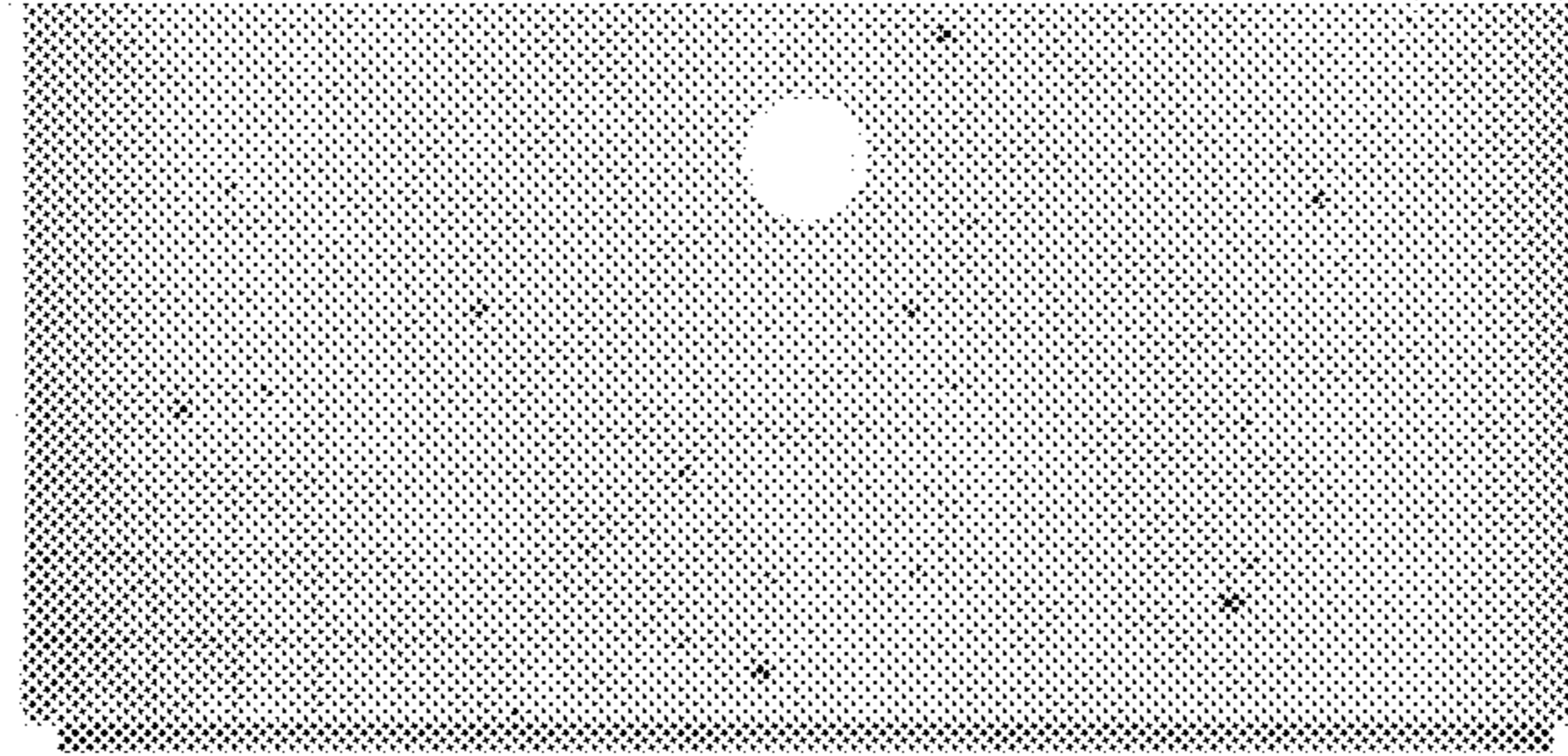

FIG. 27

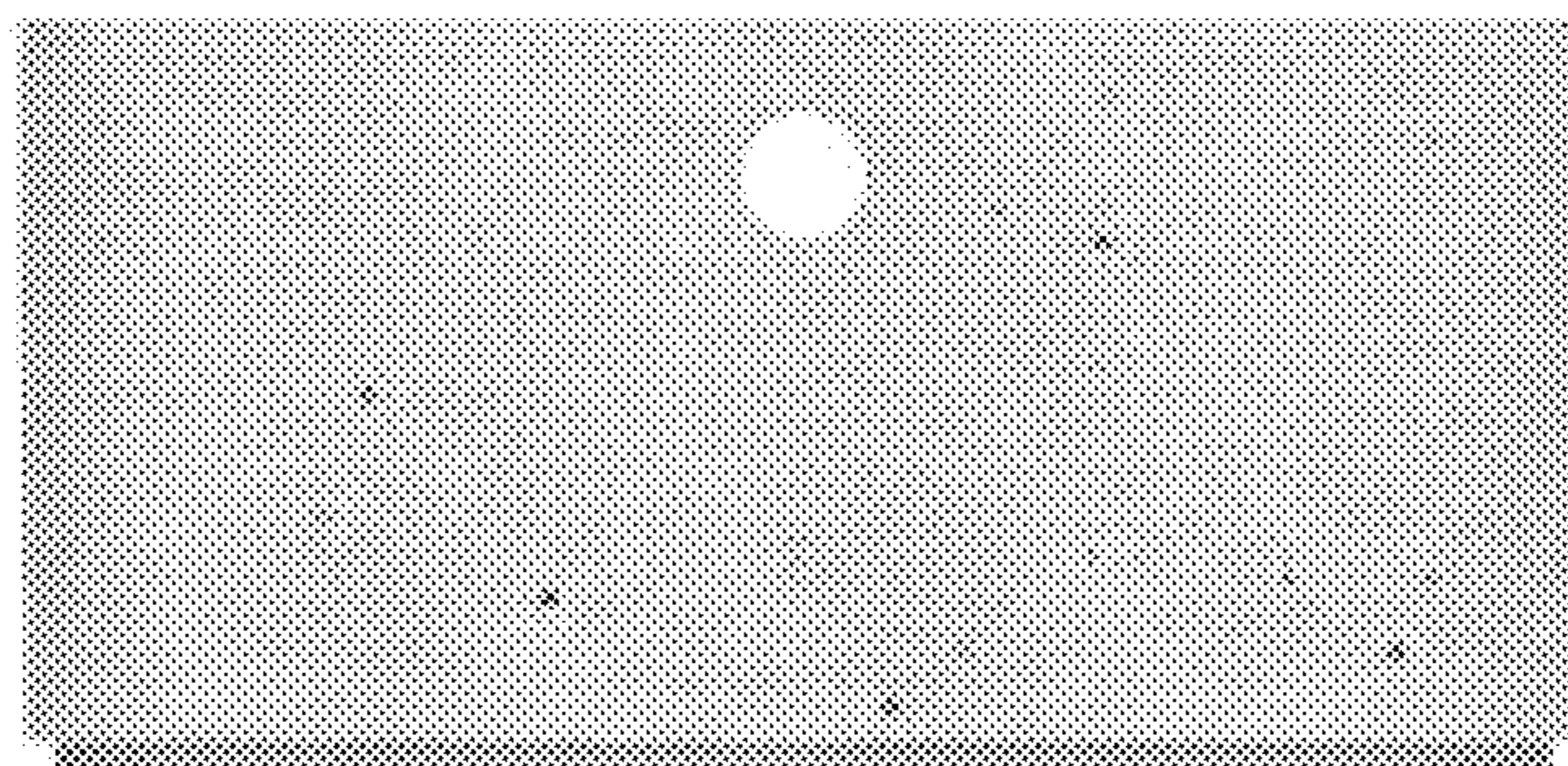

FIG. 28

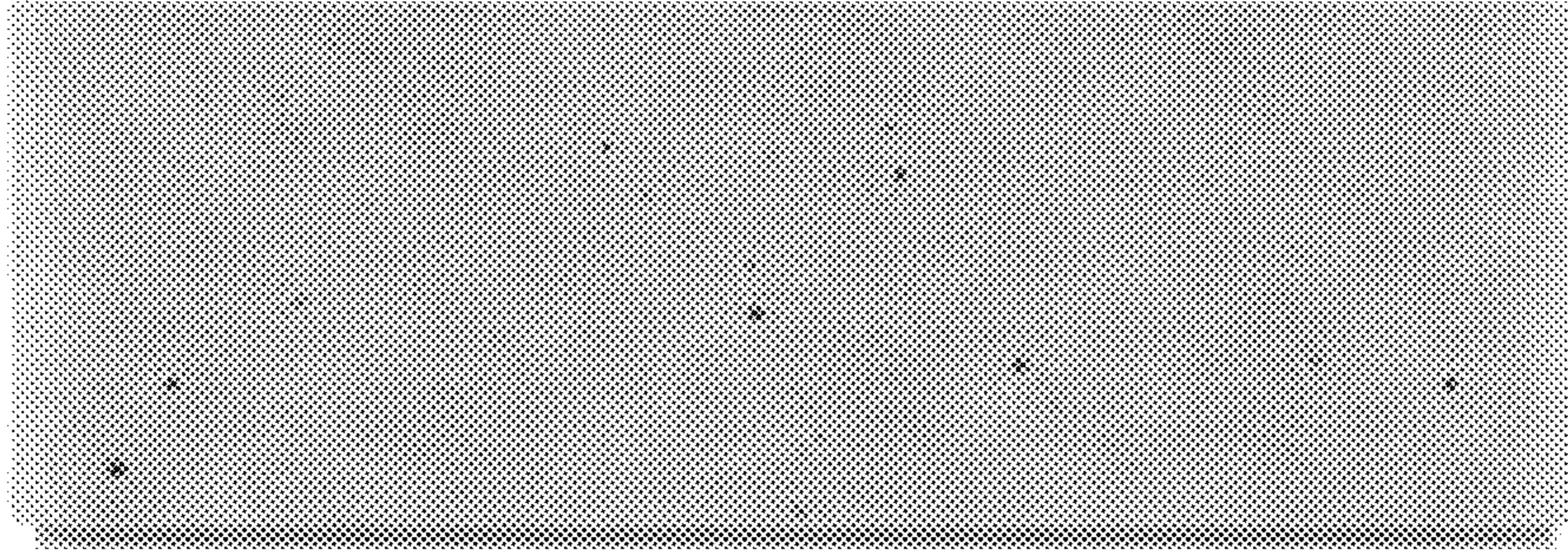

FIG. 29

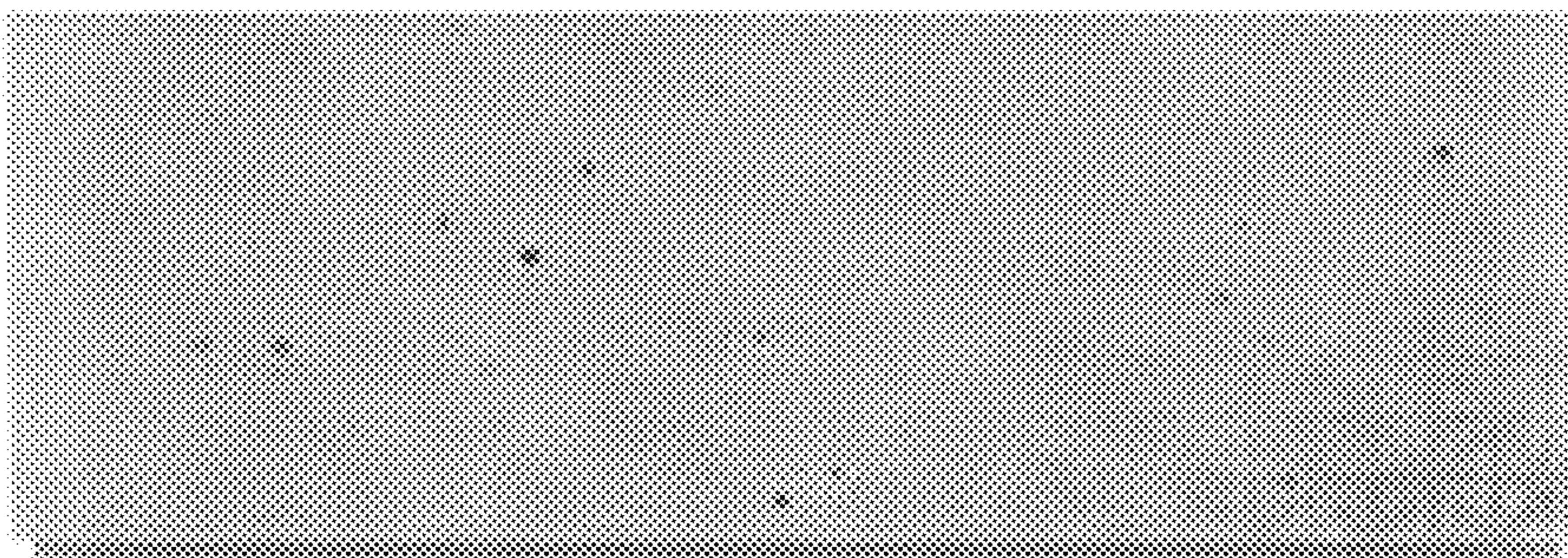

FIG. 30

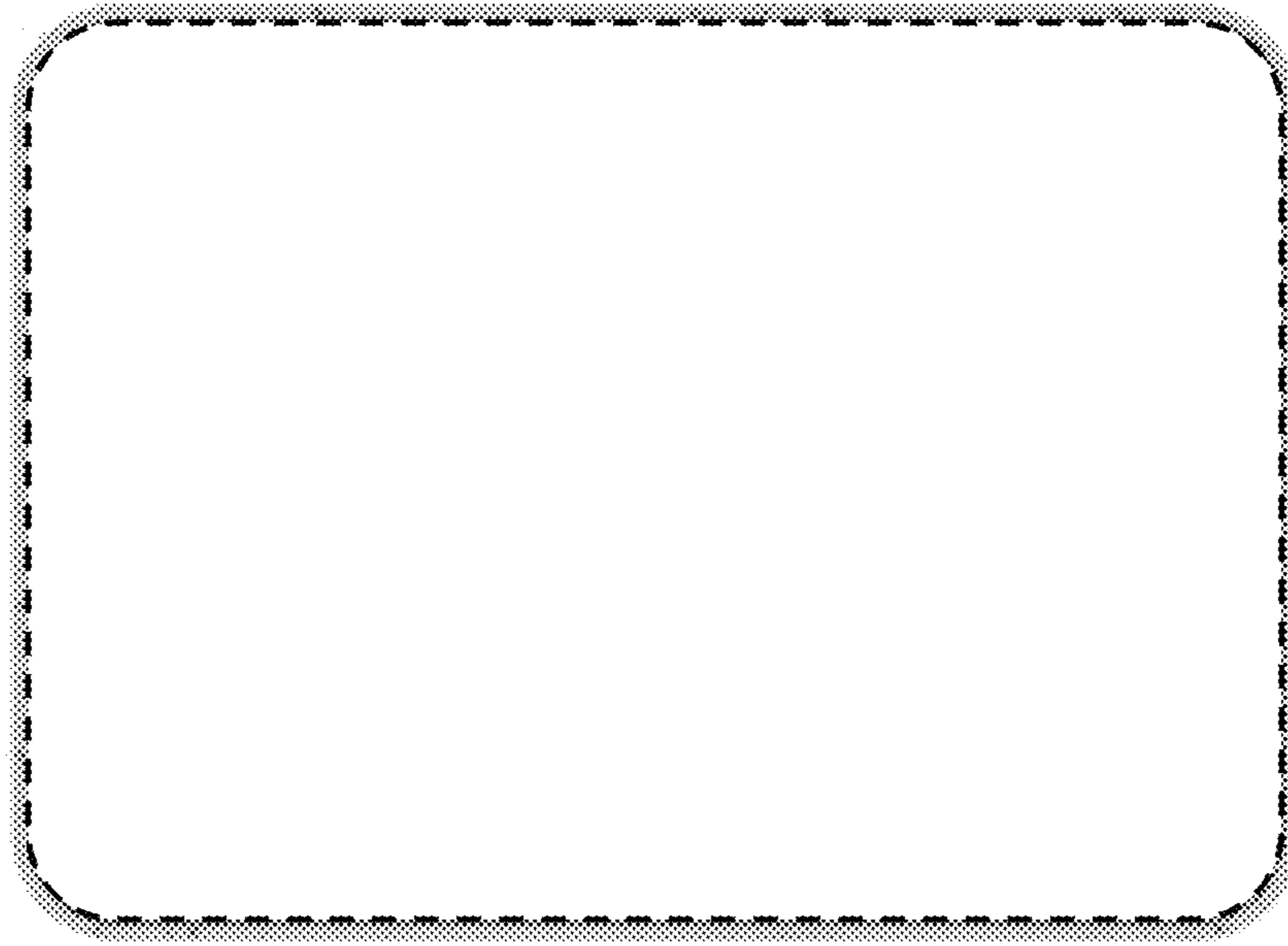

FIG. 31

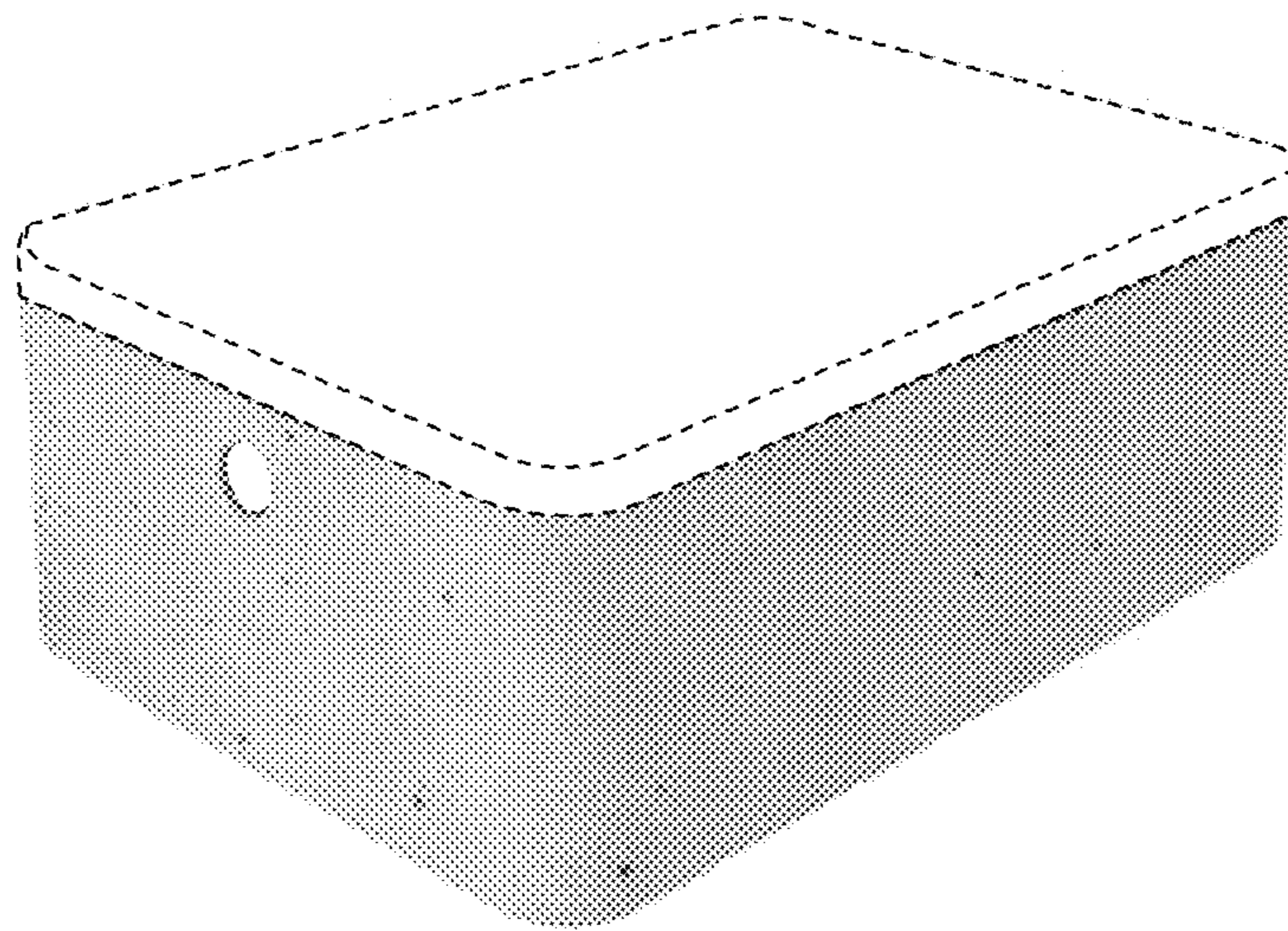

FIG. 32

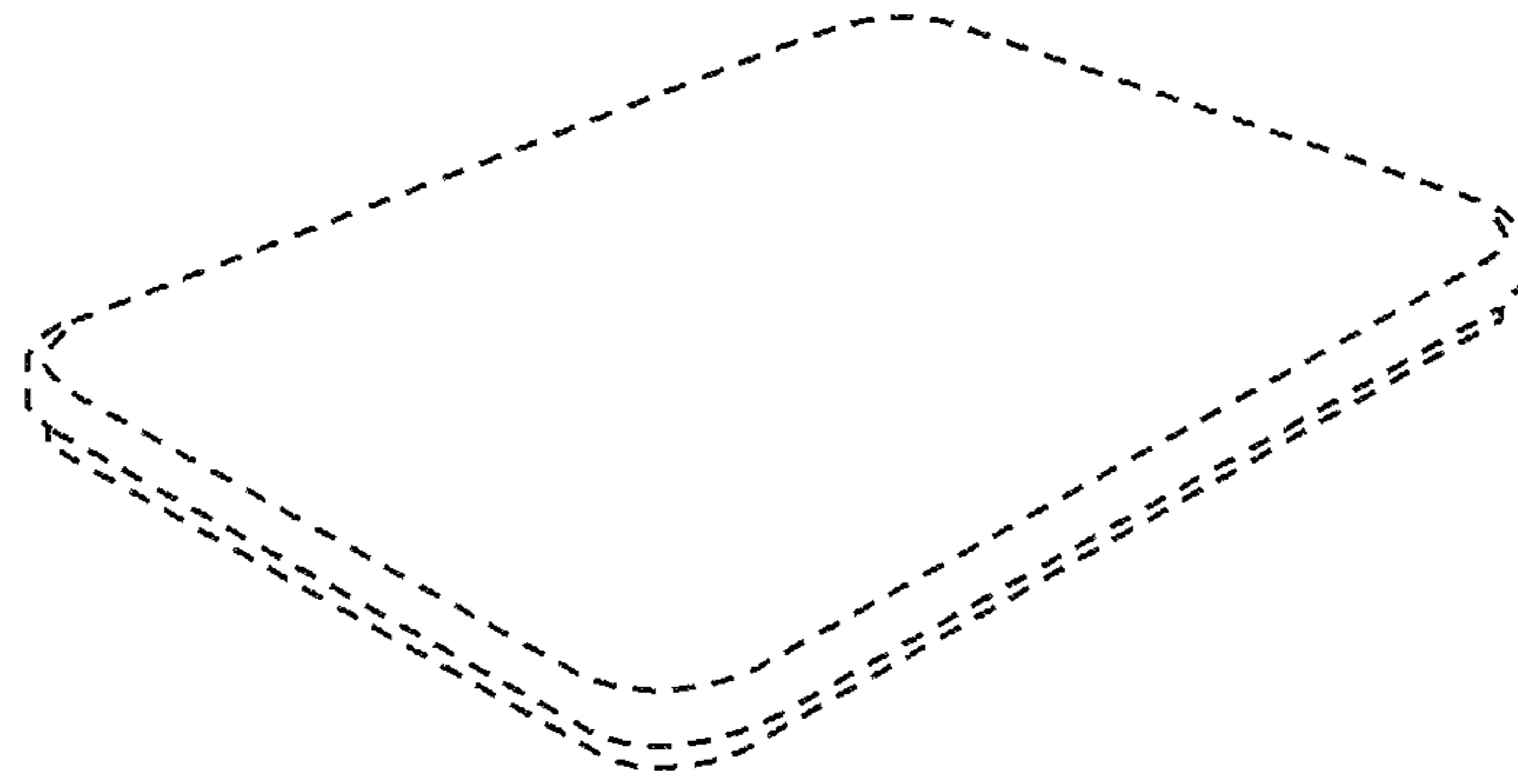

FIG. 33

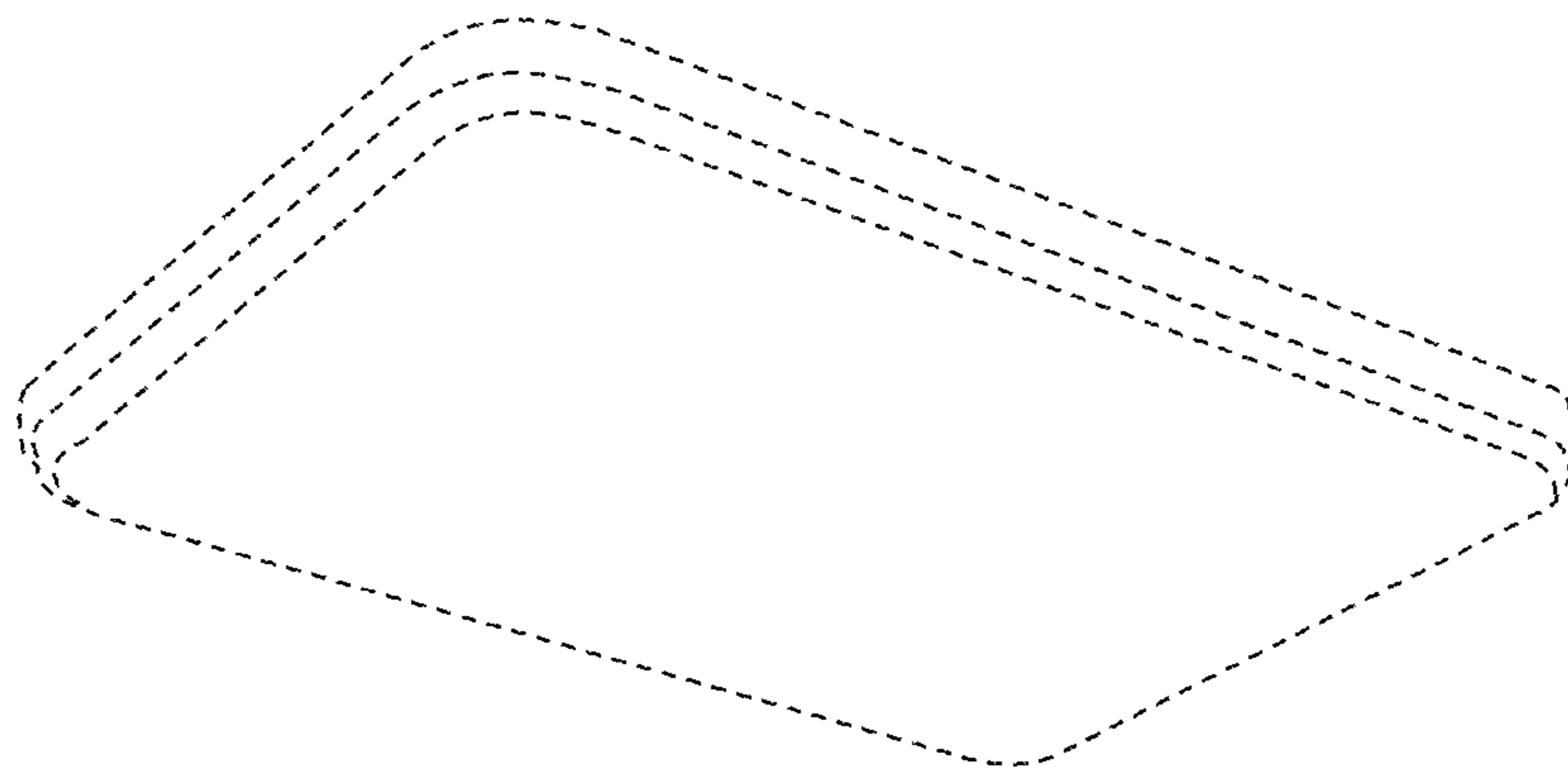

FIG. 34



FIG. 35



FIG. 36



FIG. 37

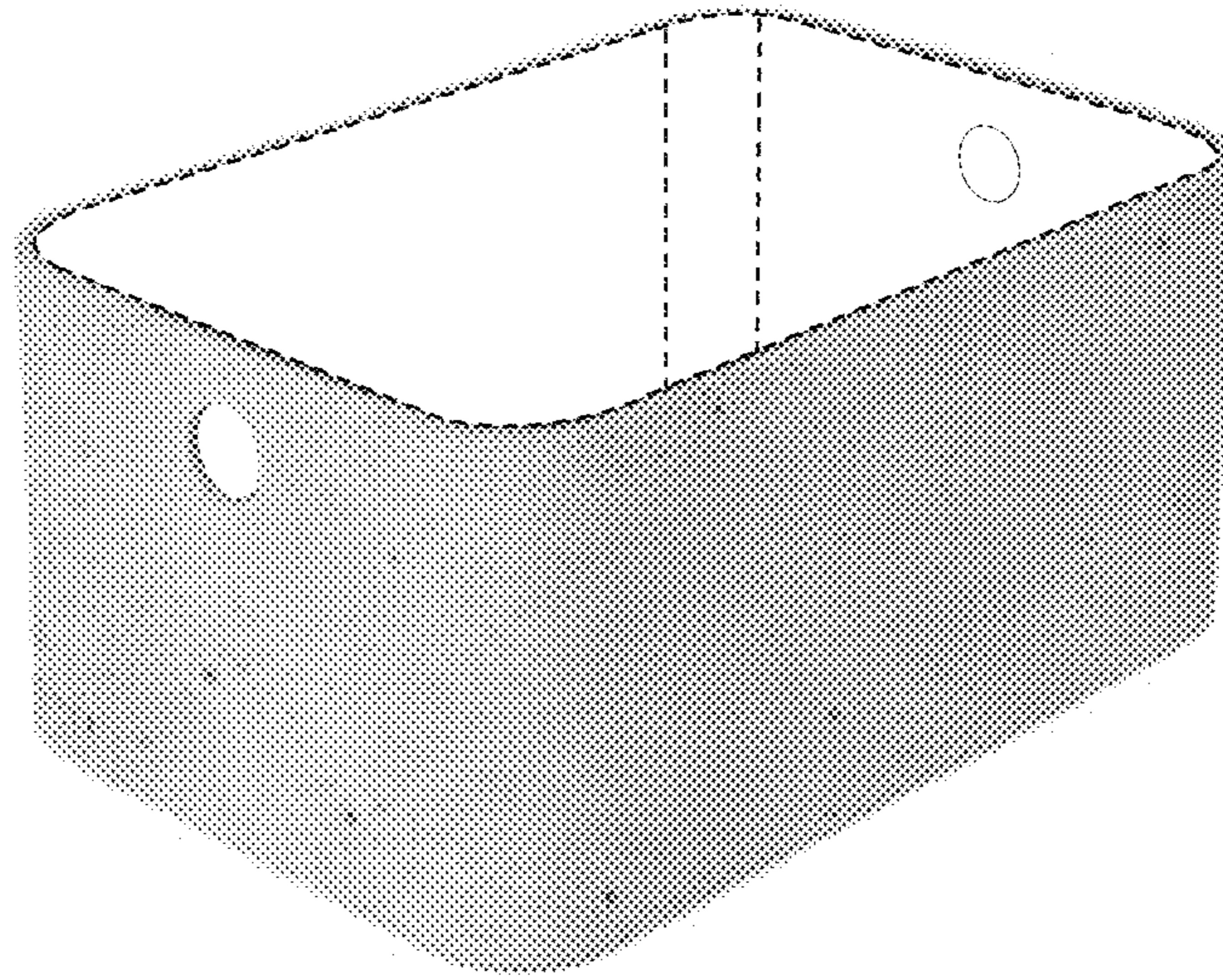

FIG. 38

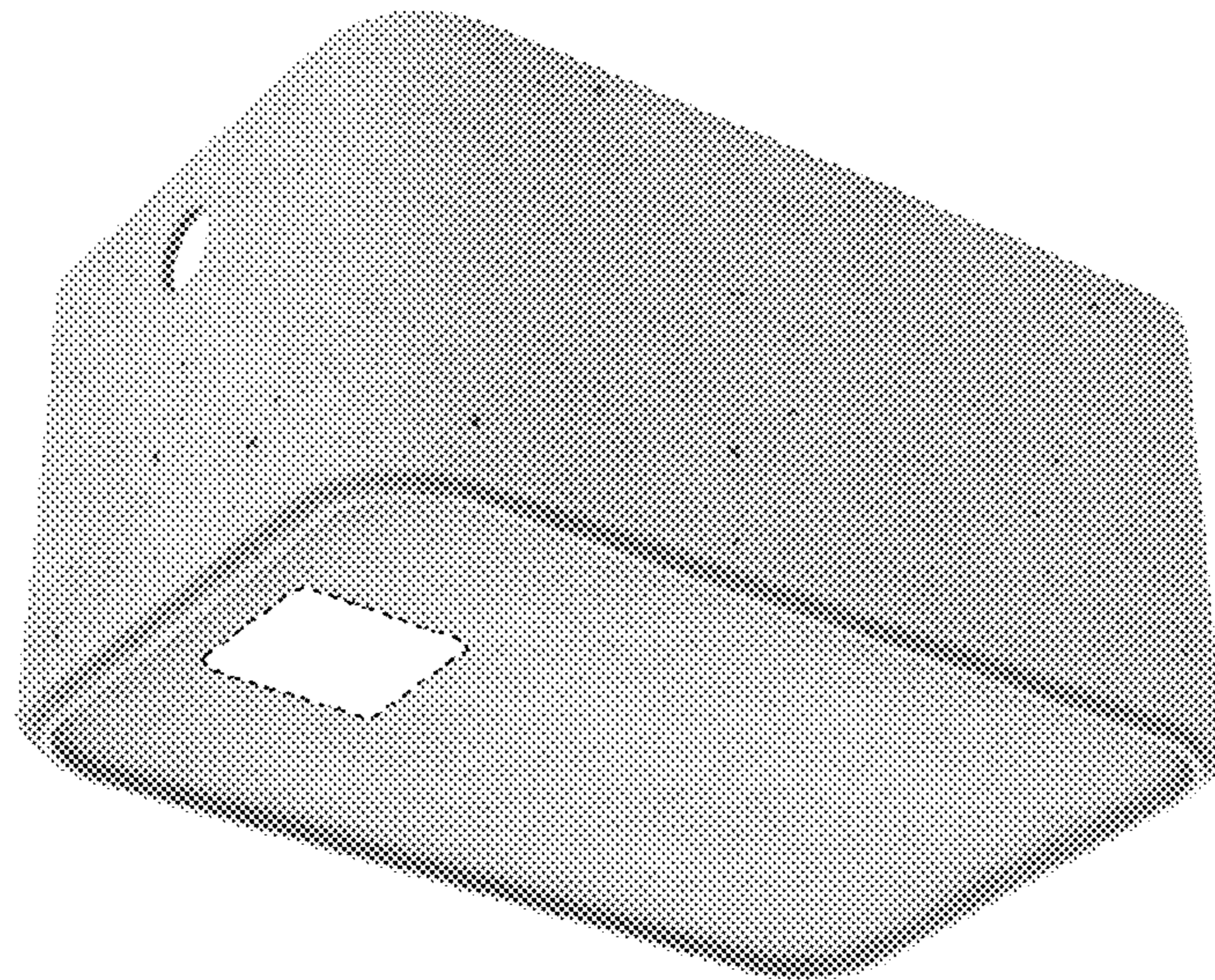

FIG. 39

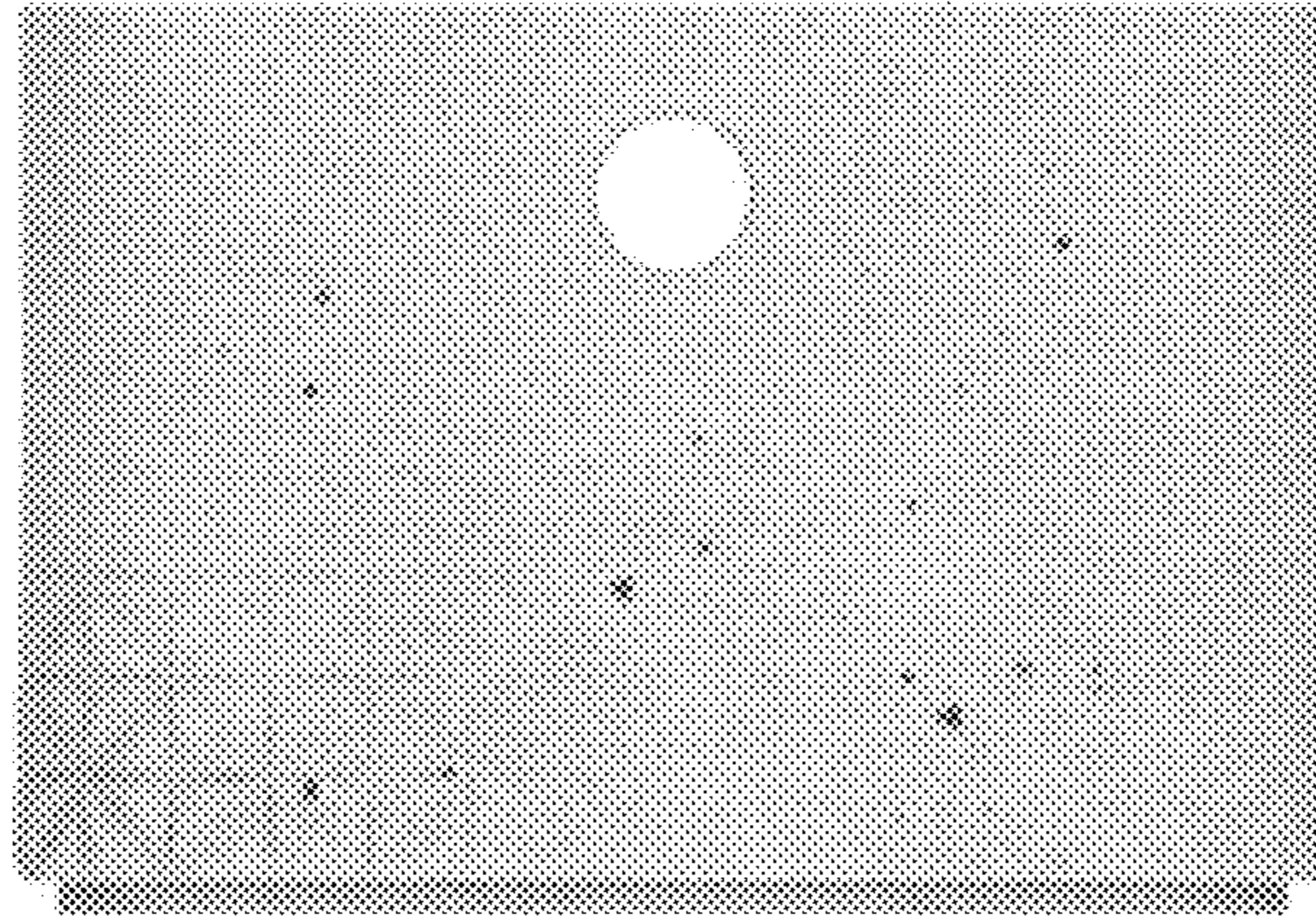

FIG. 40

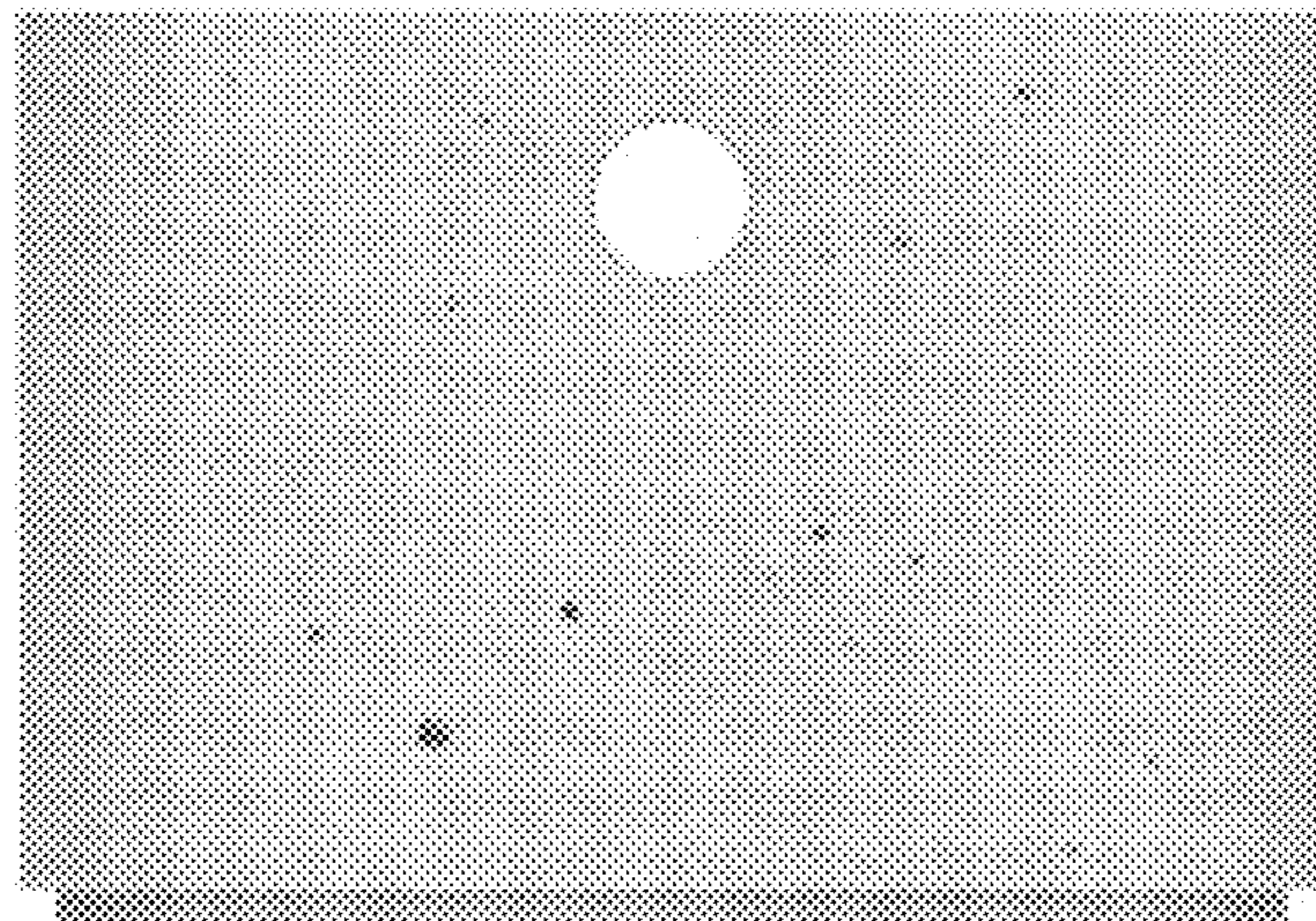

FIG. 41

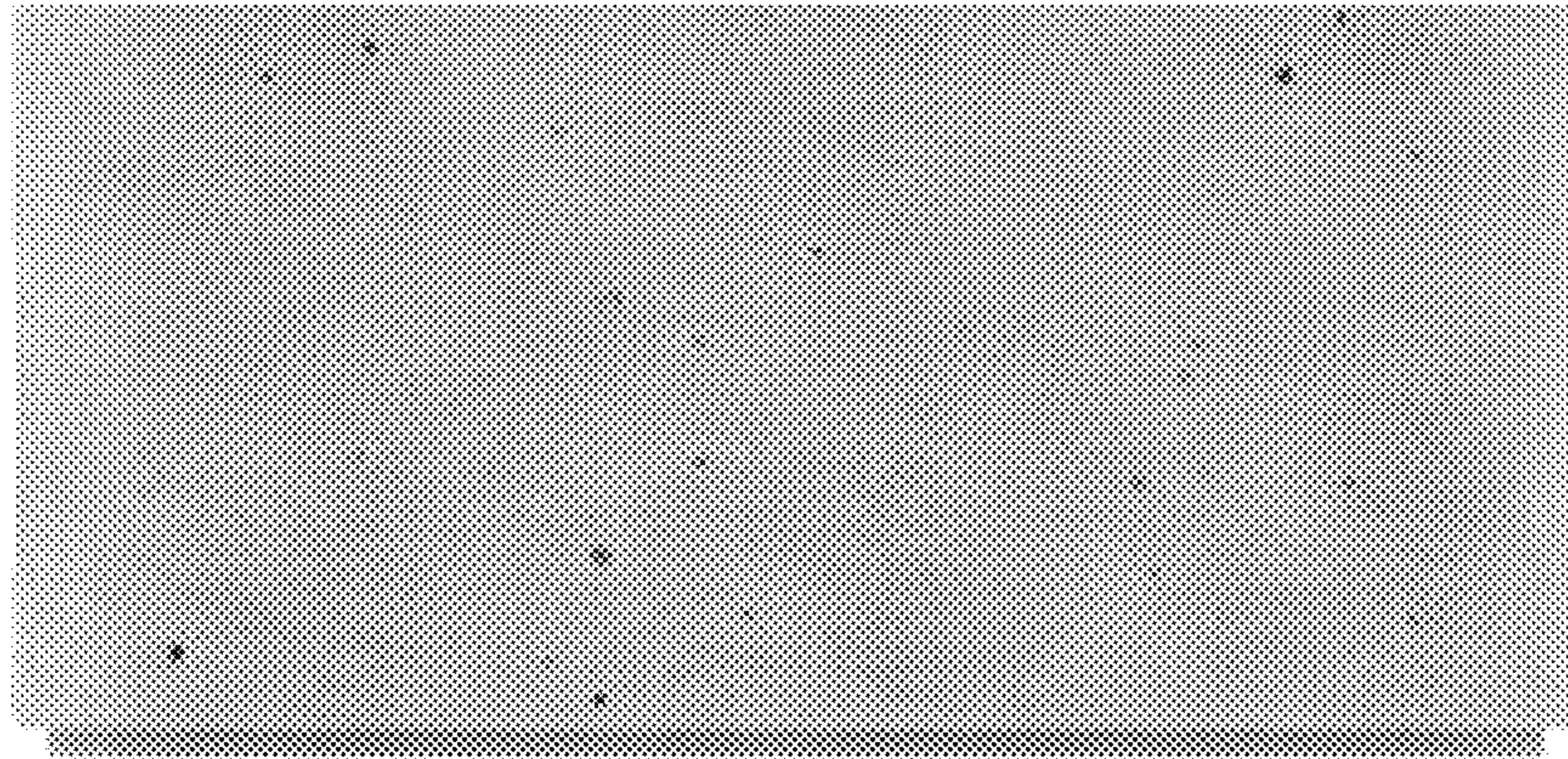

FIG. 42

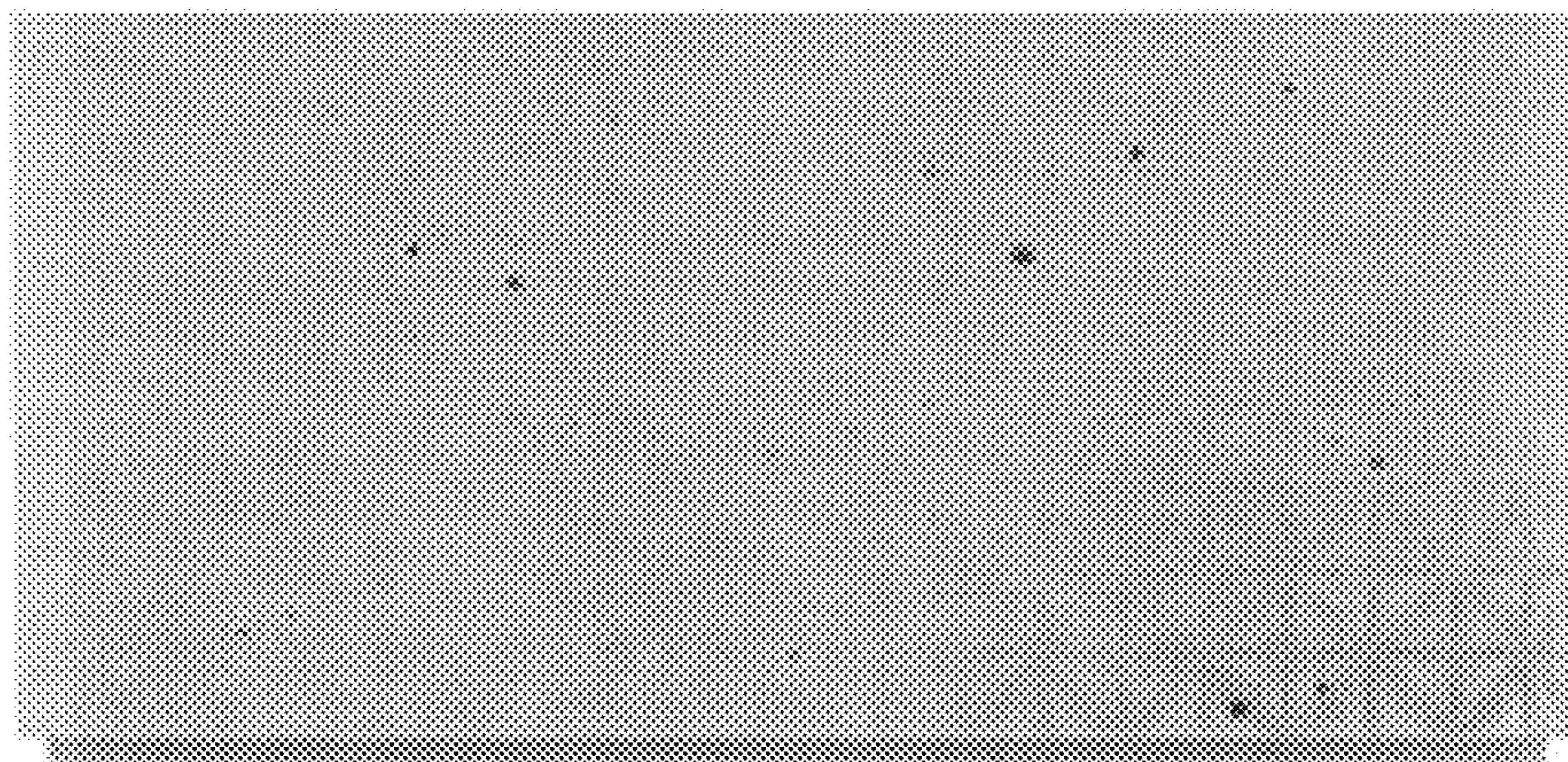

FIG. 43

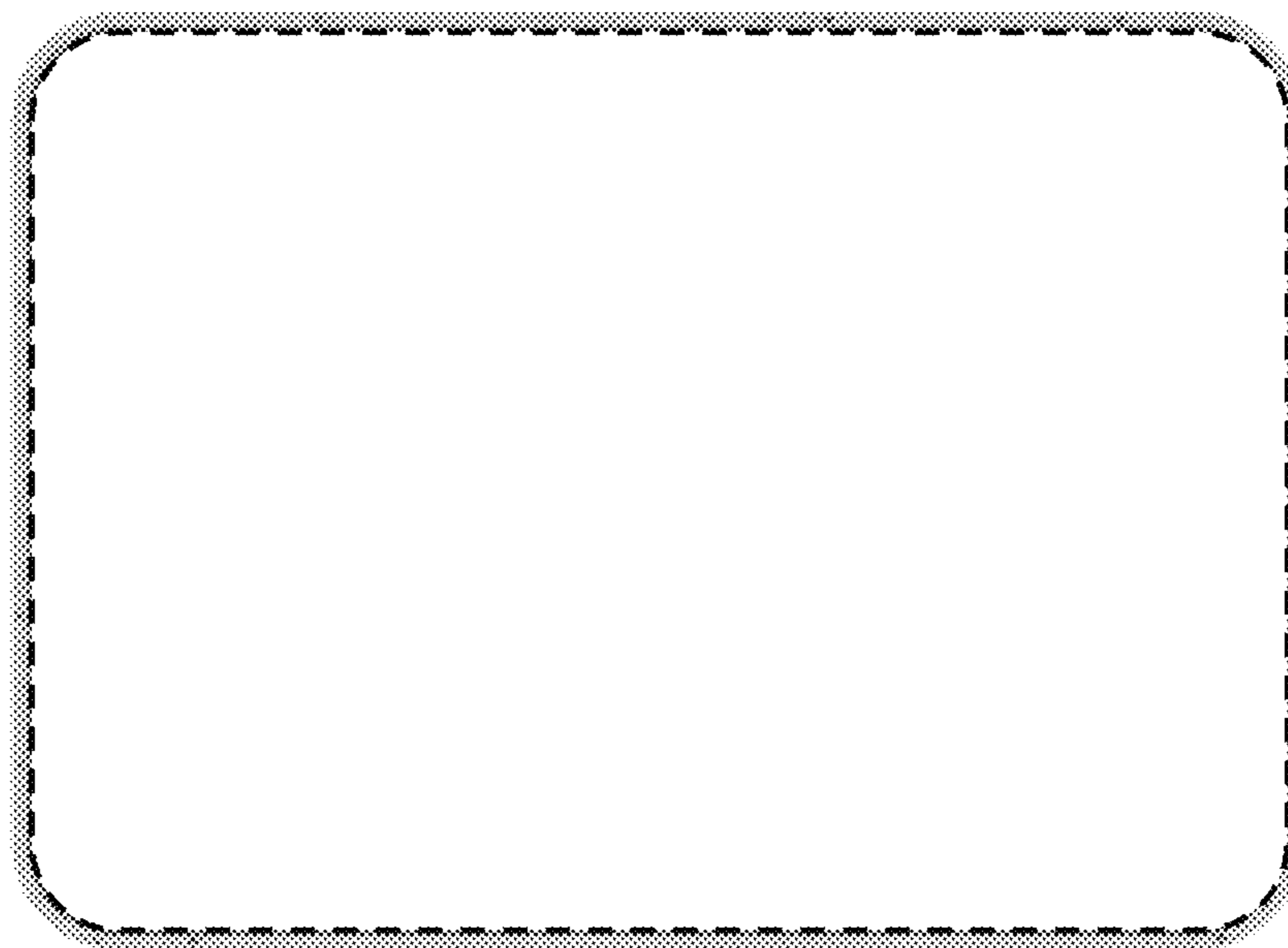

FIG. 44

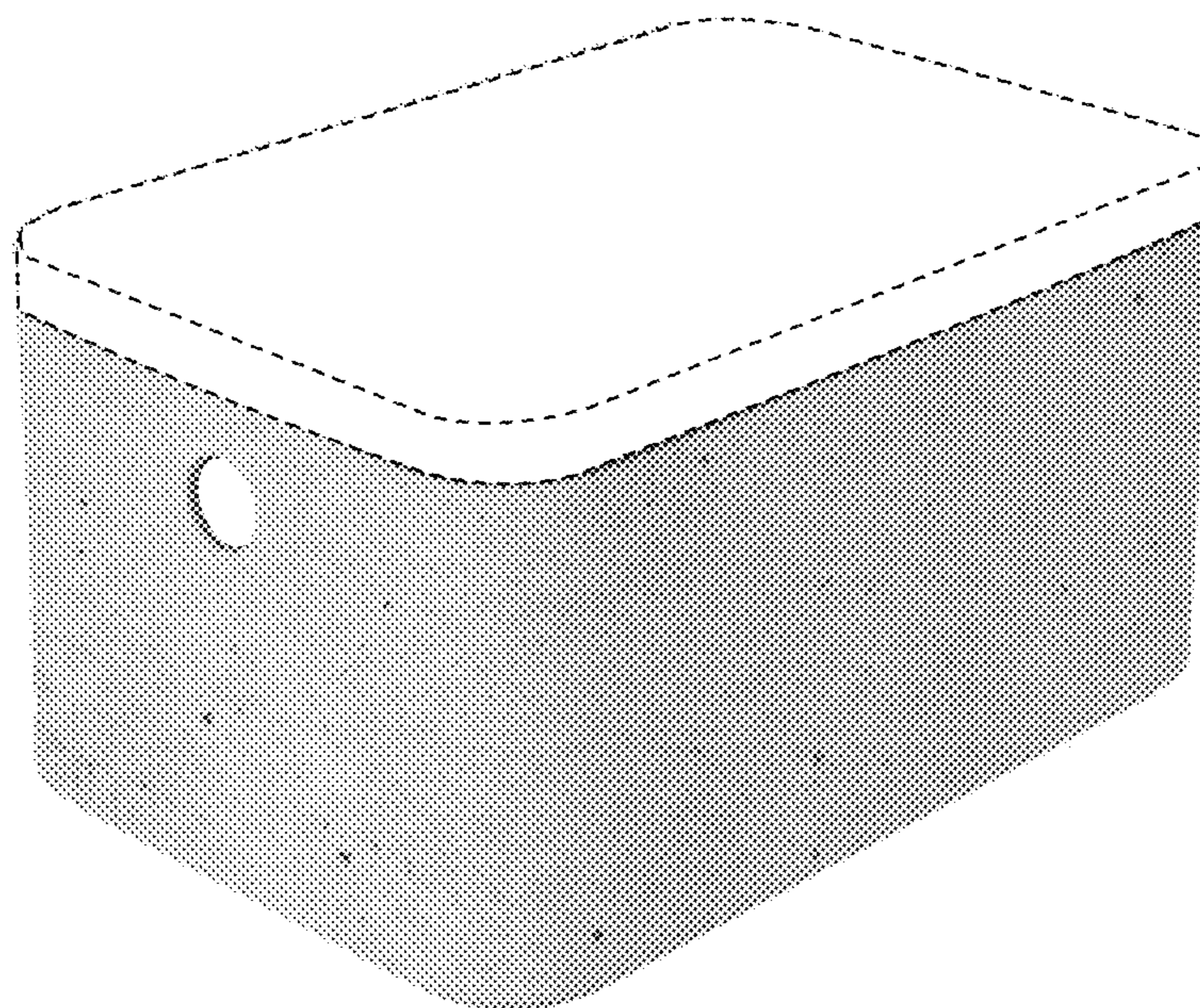

FIG. 45

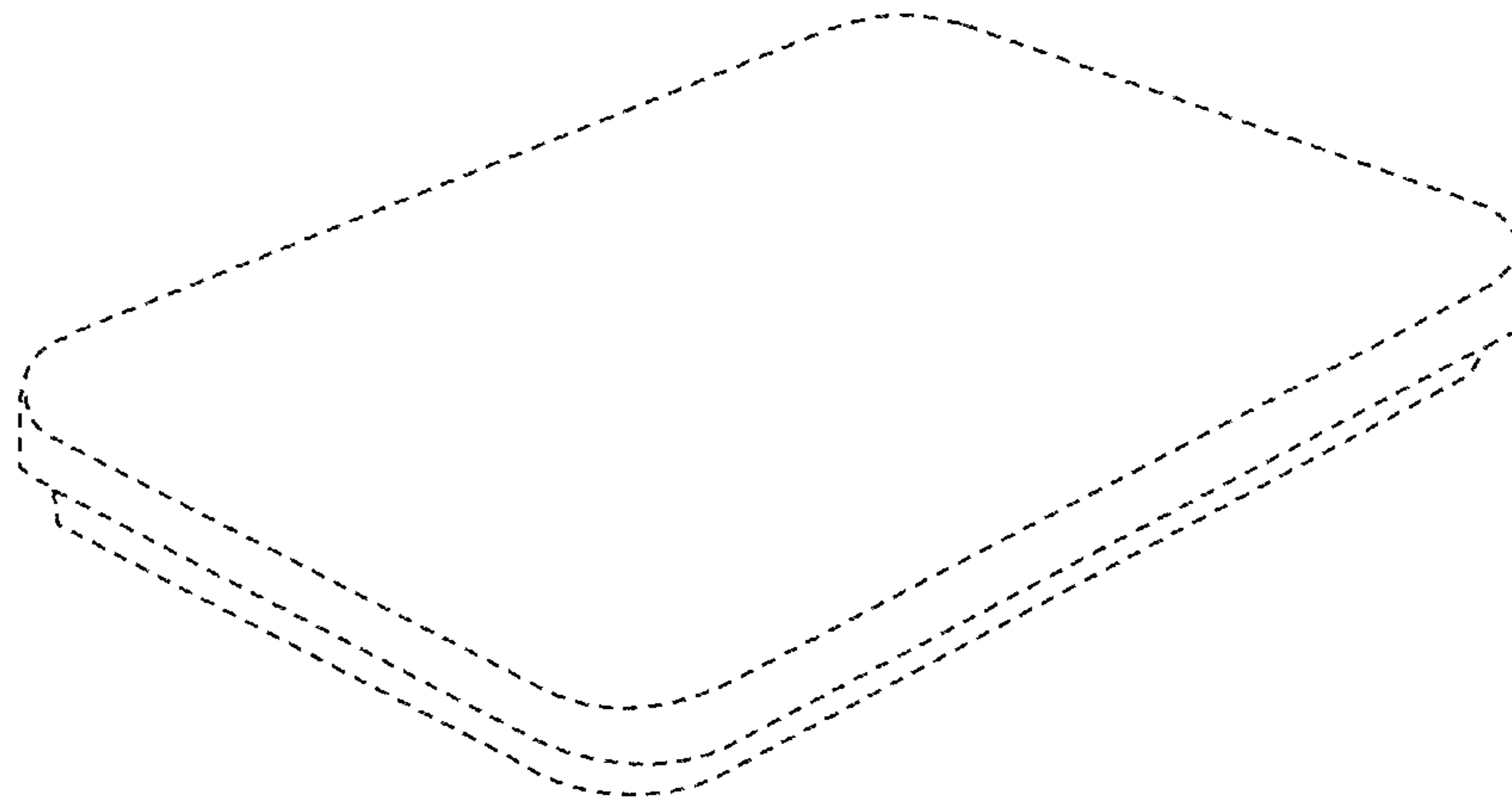

FIG. 46

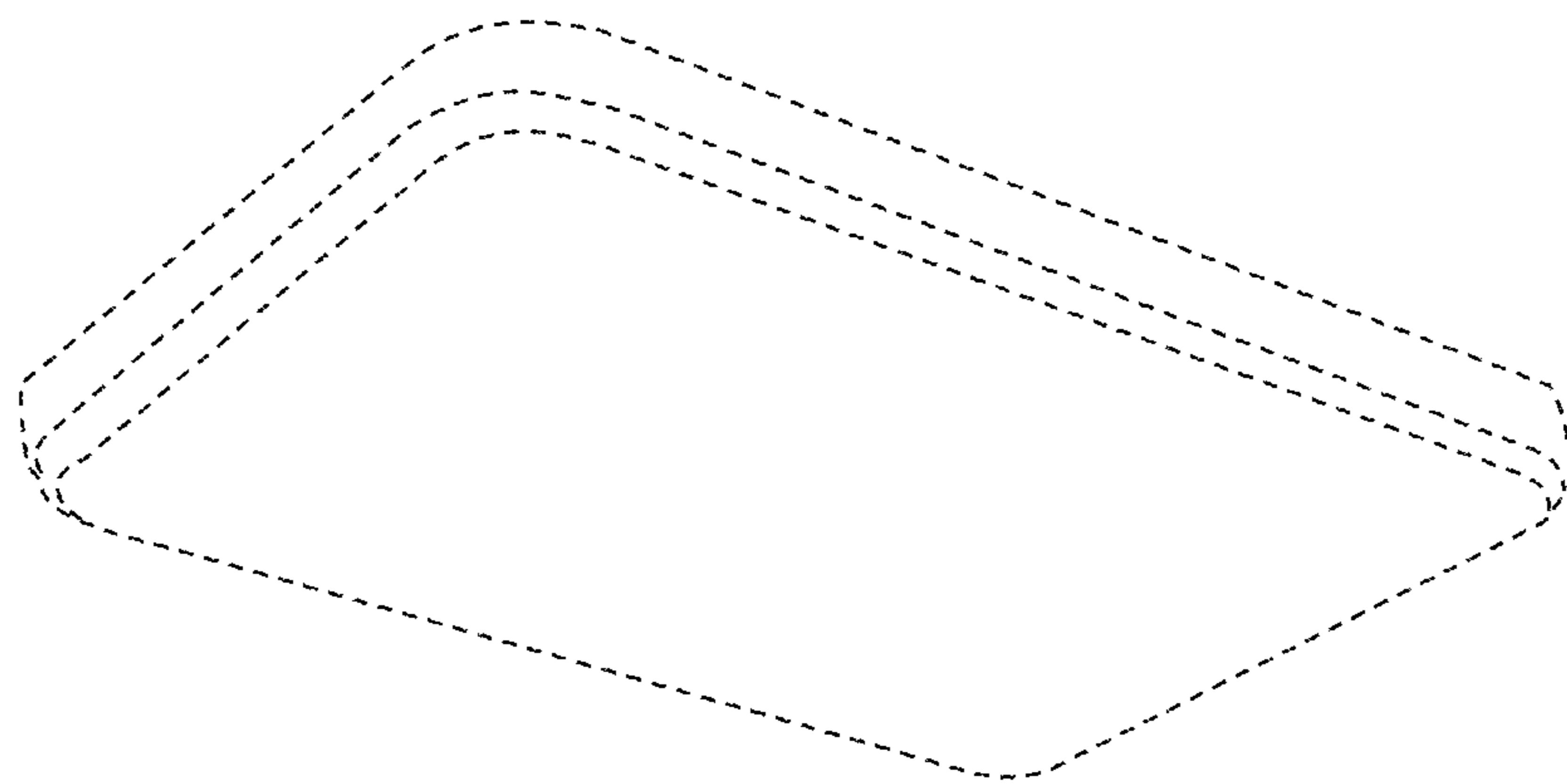

FIG. 47



FIG. 48



FIG. 49

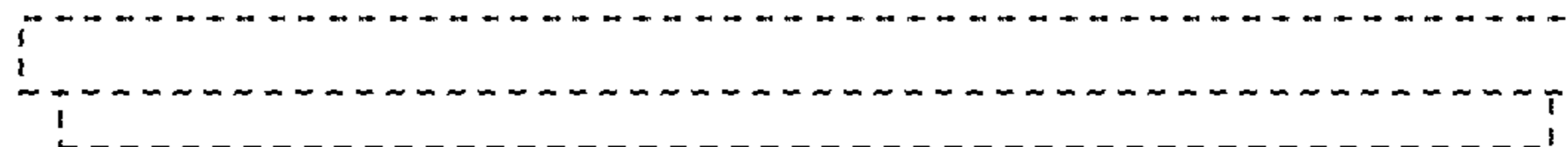

FIG. 50

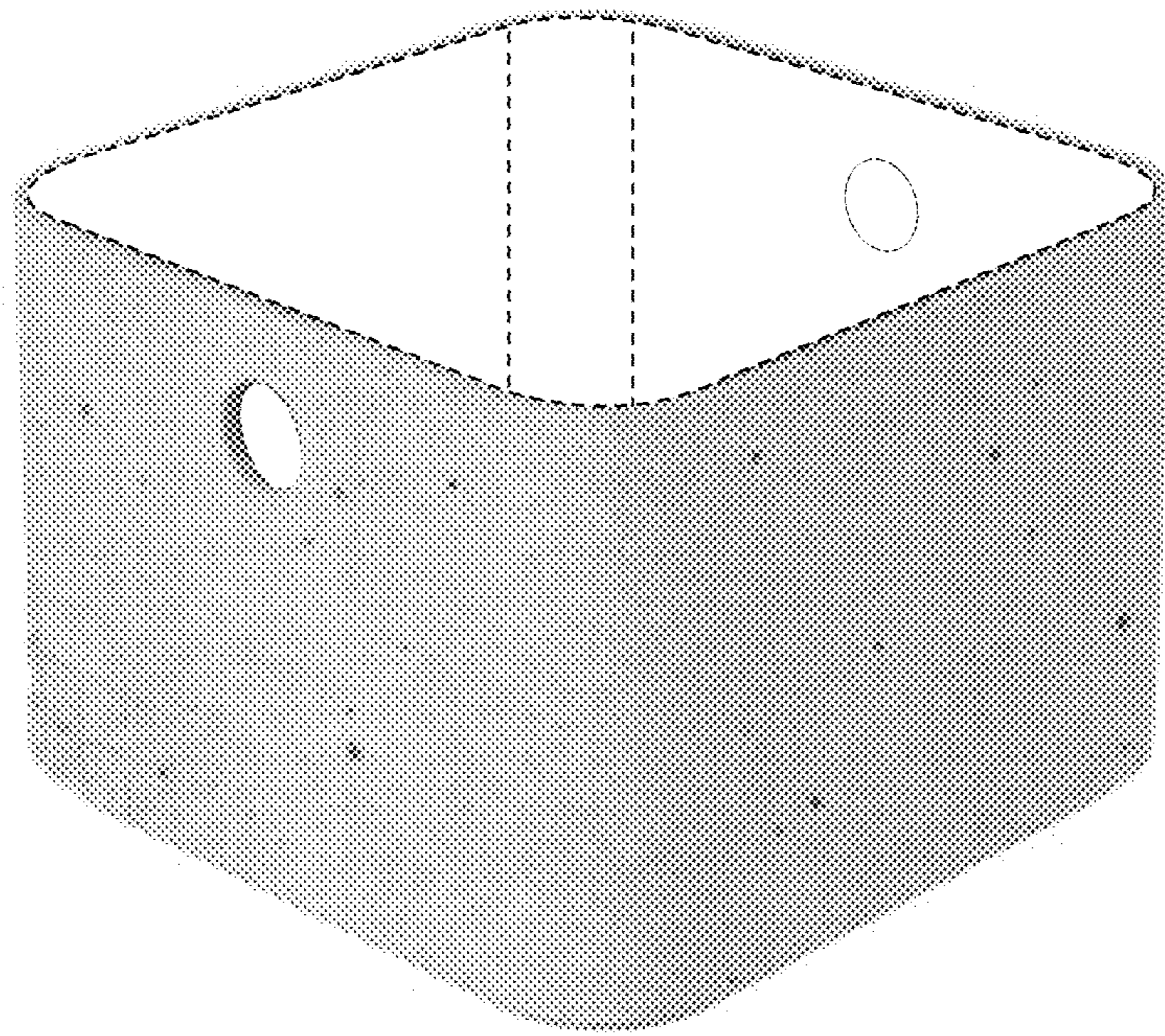

FIG. 51

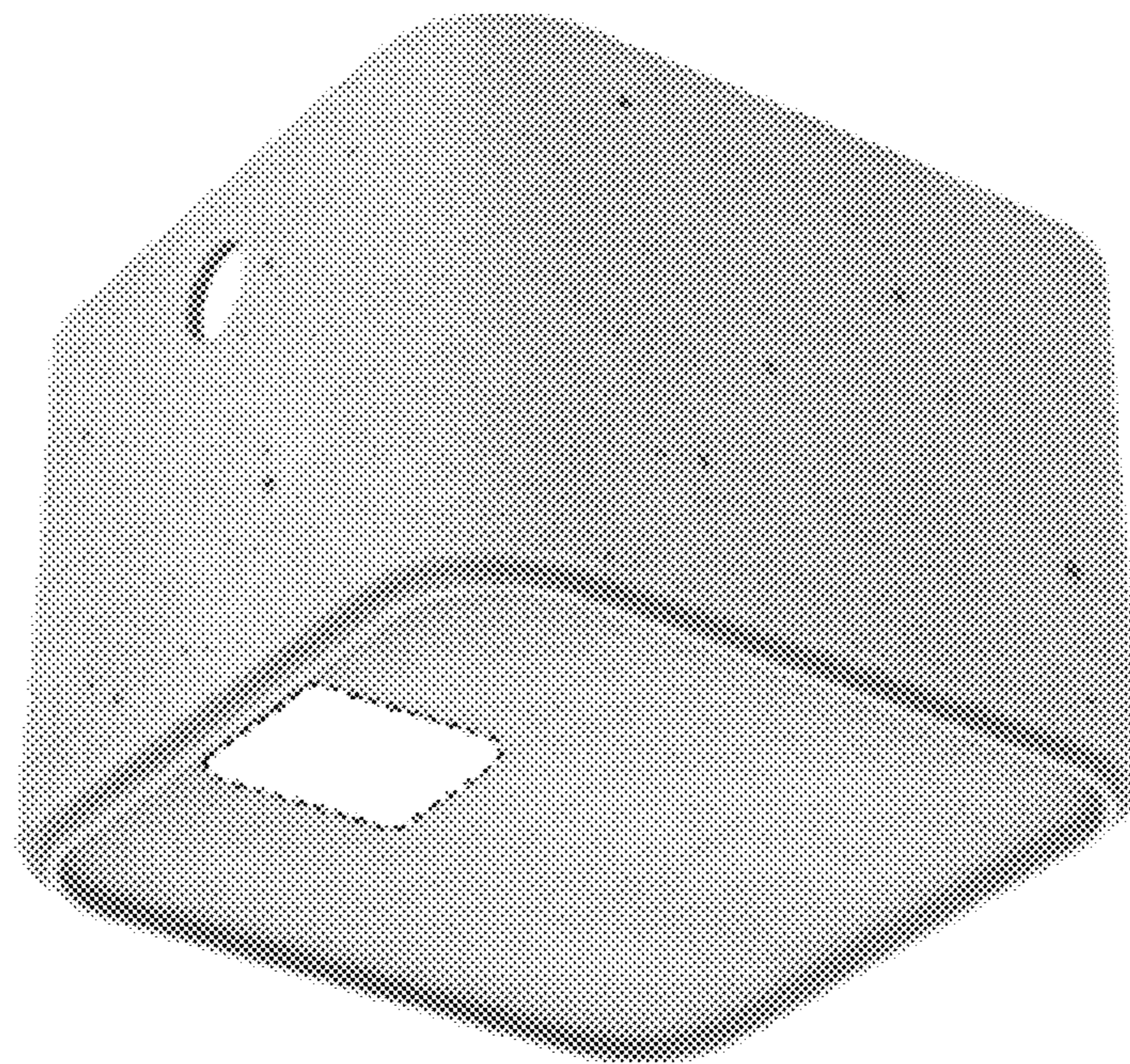

FIG. 52

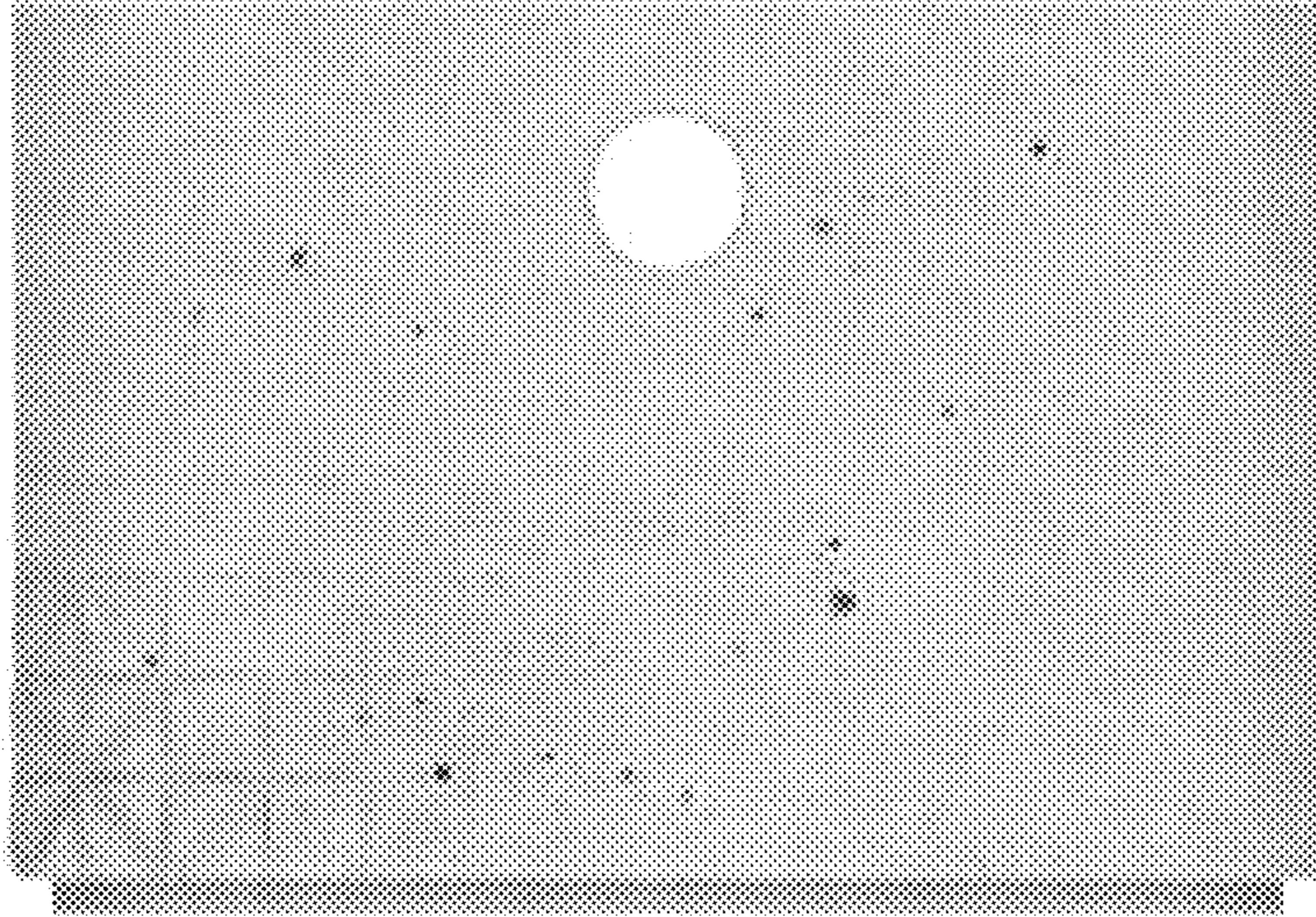

FIG. 53

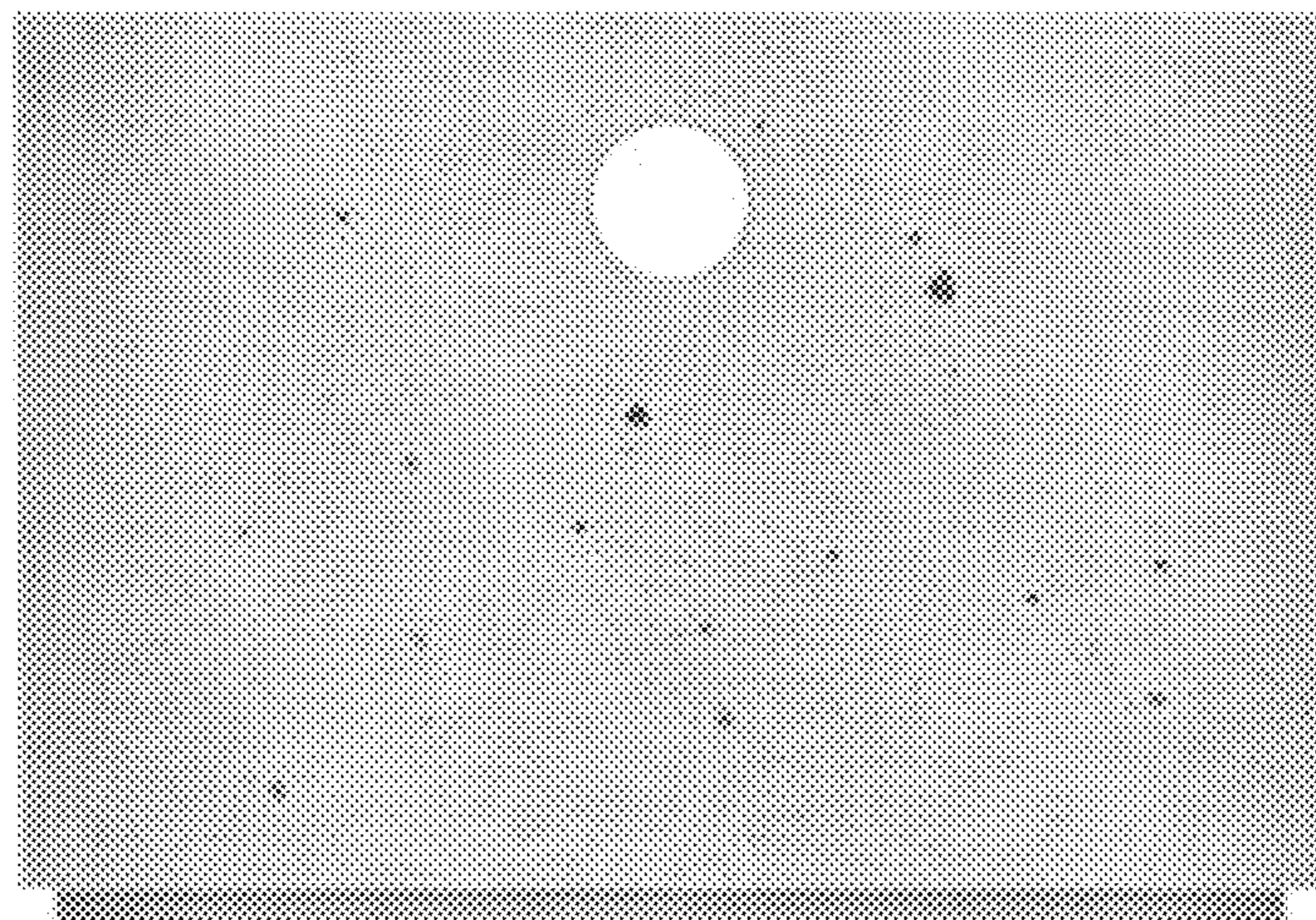

FIG. 54

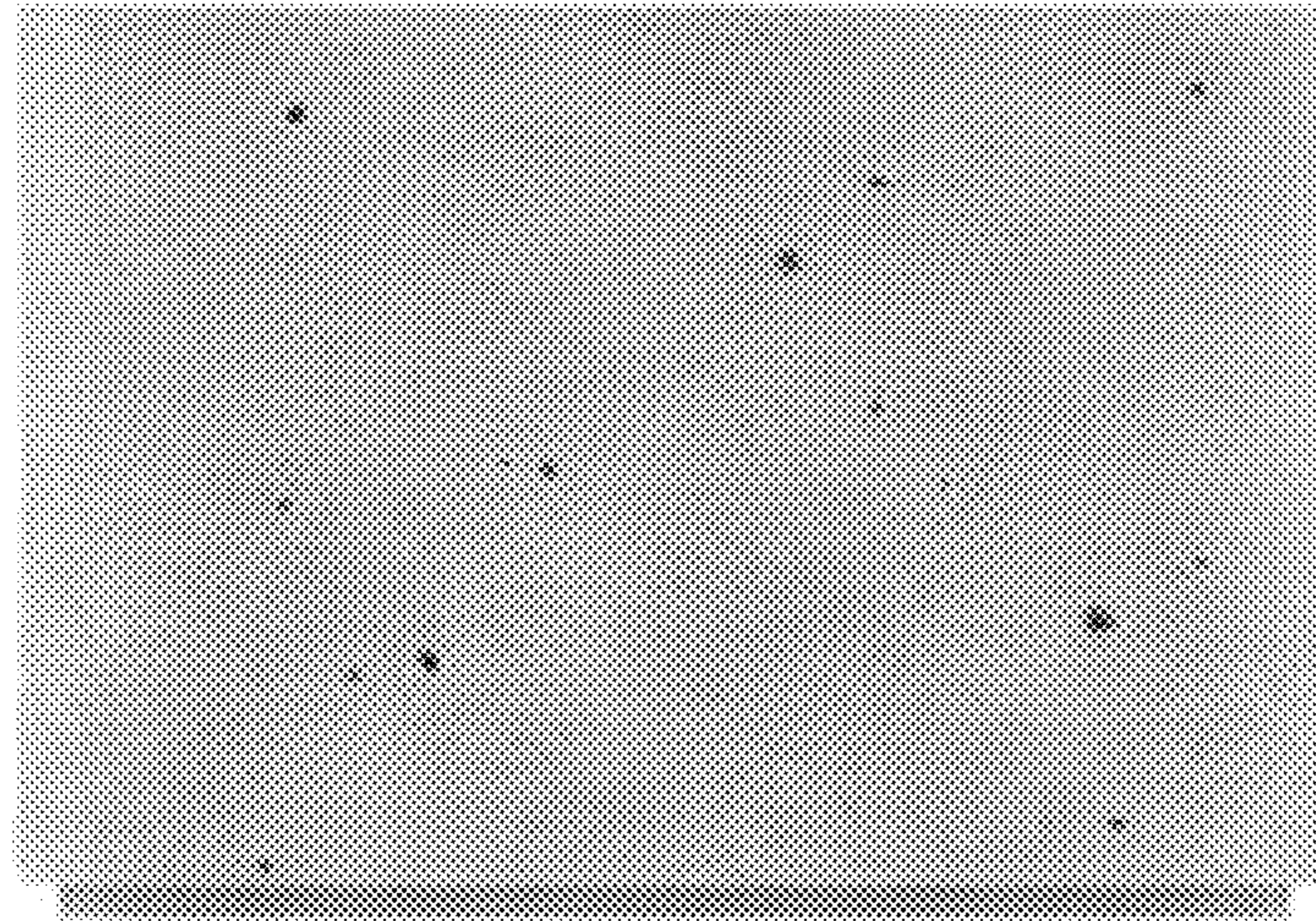

FIG. 55

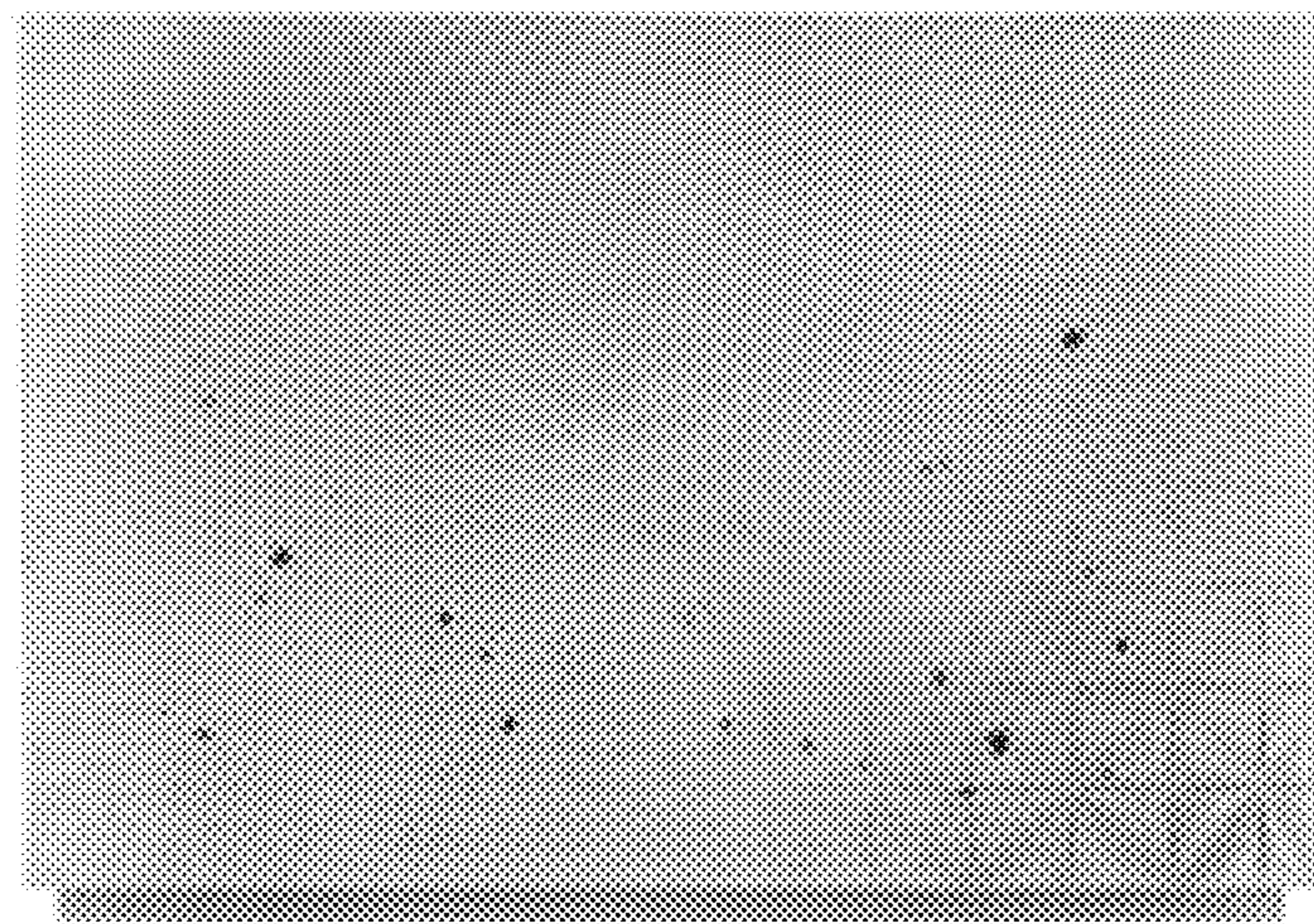

FIG. 56

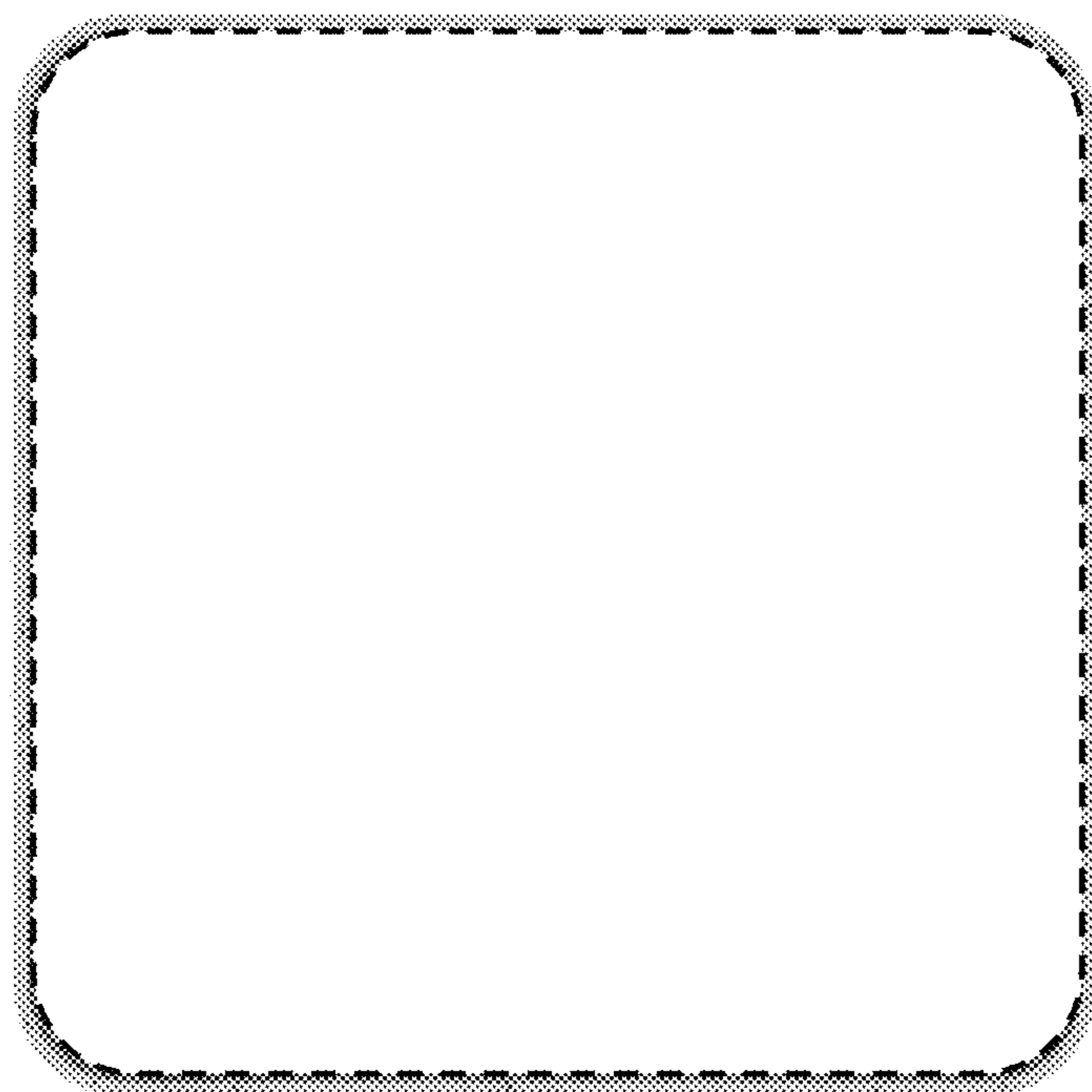

FIG. 57

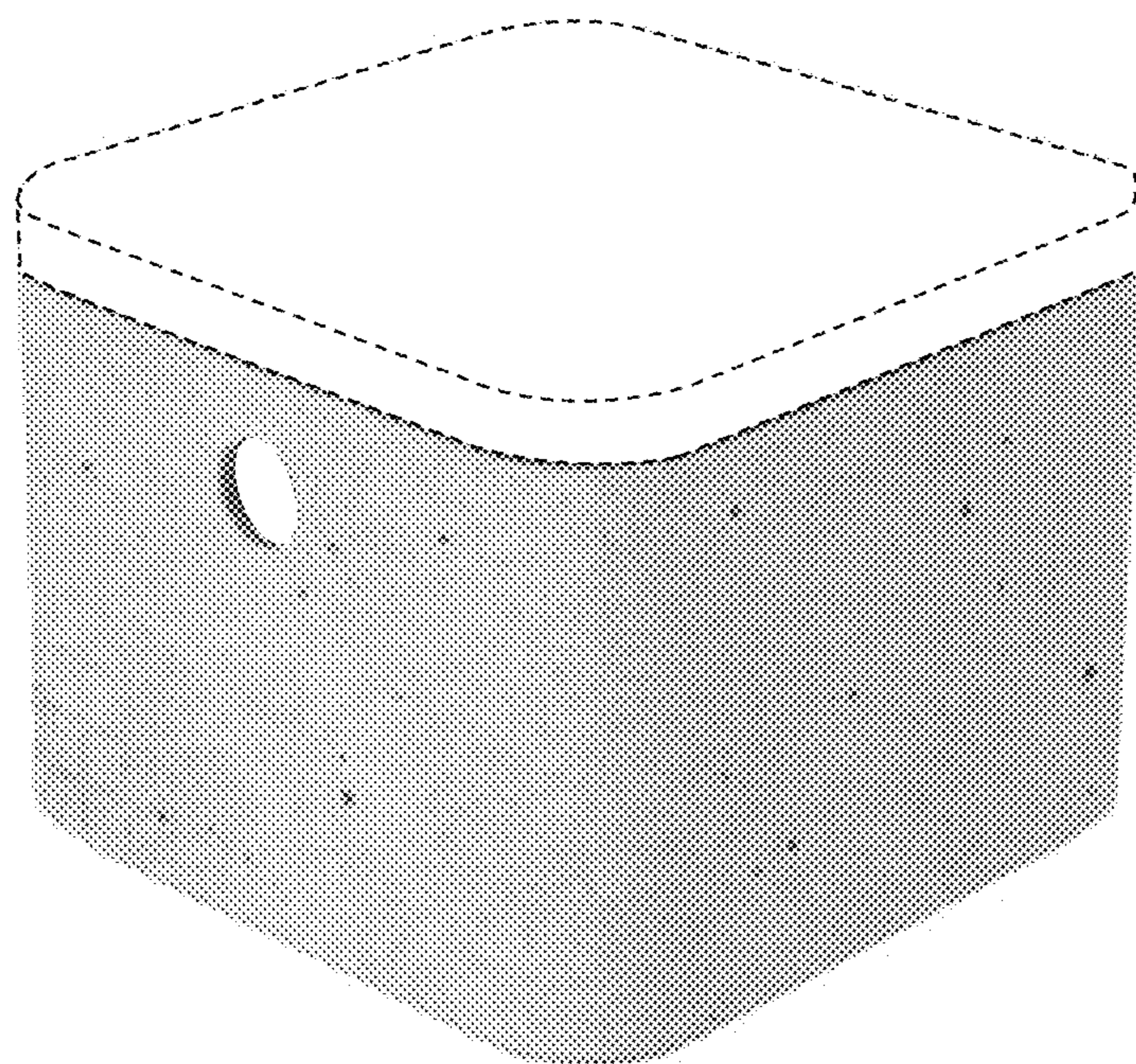

FIG. 58

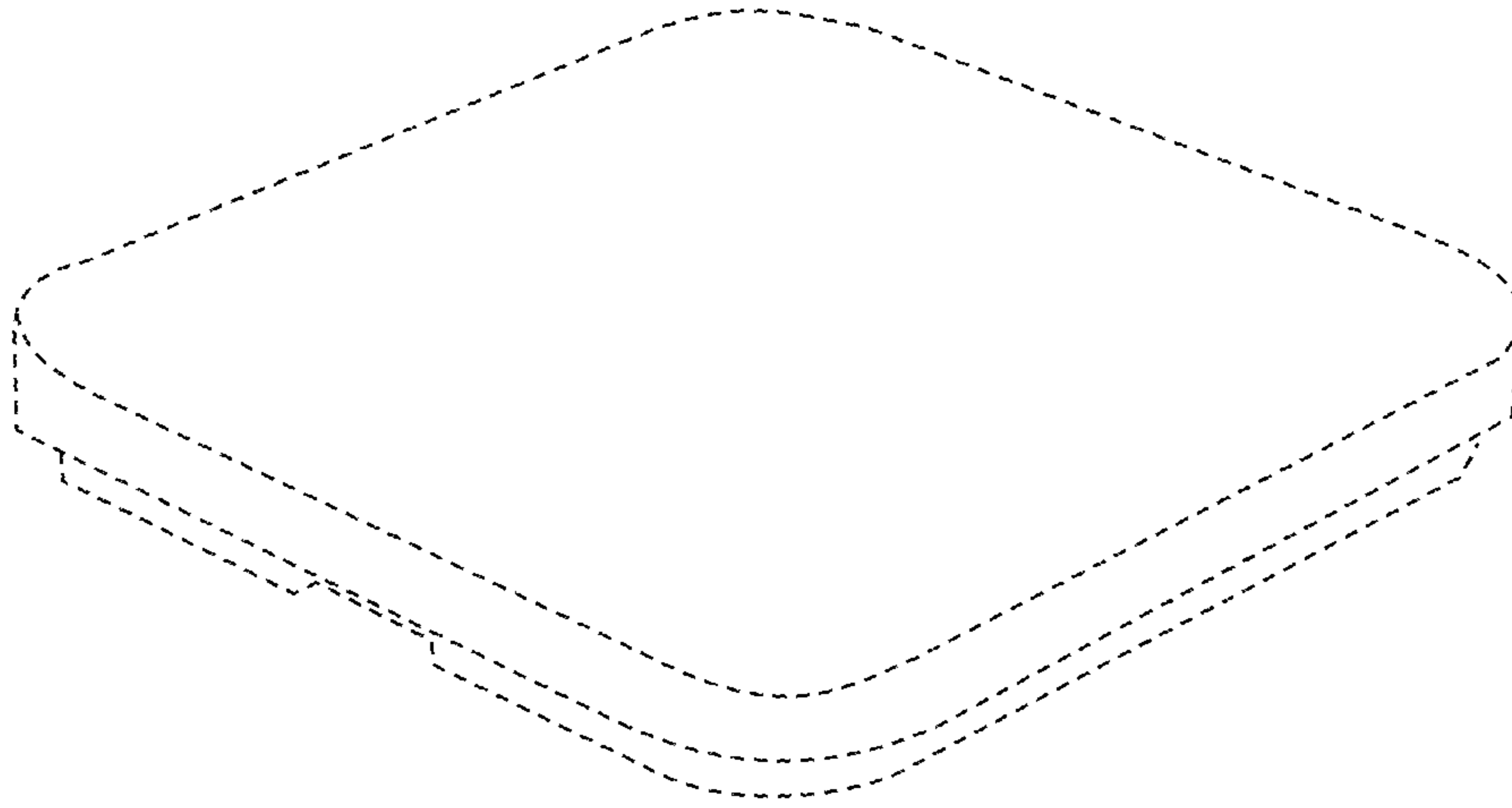

FIG. 59

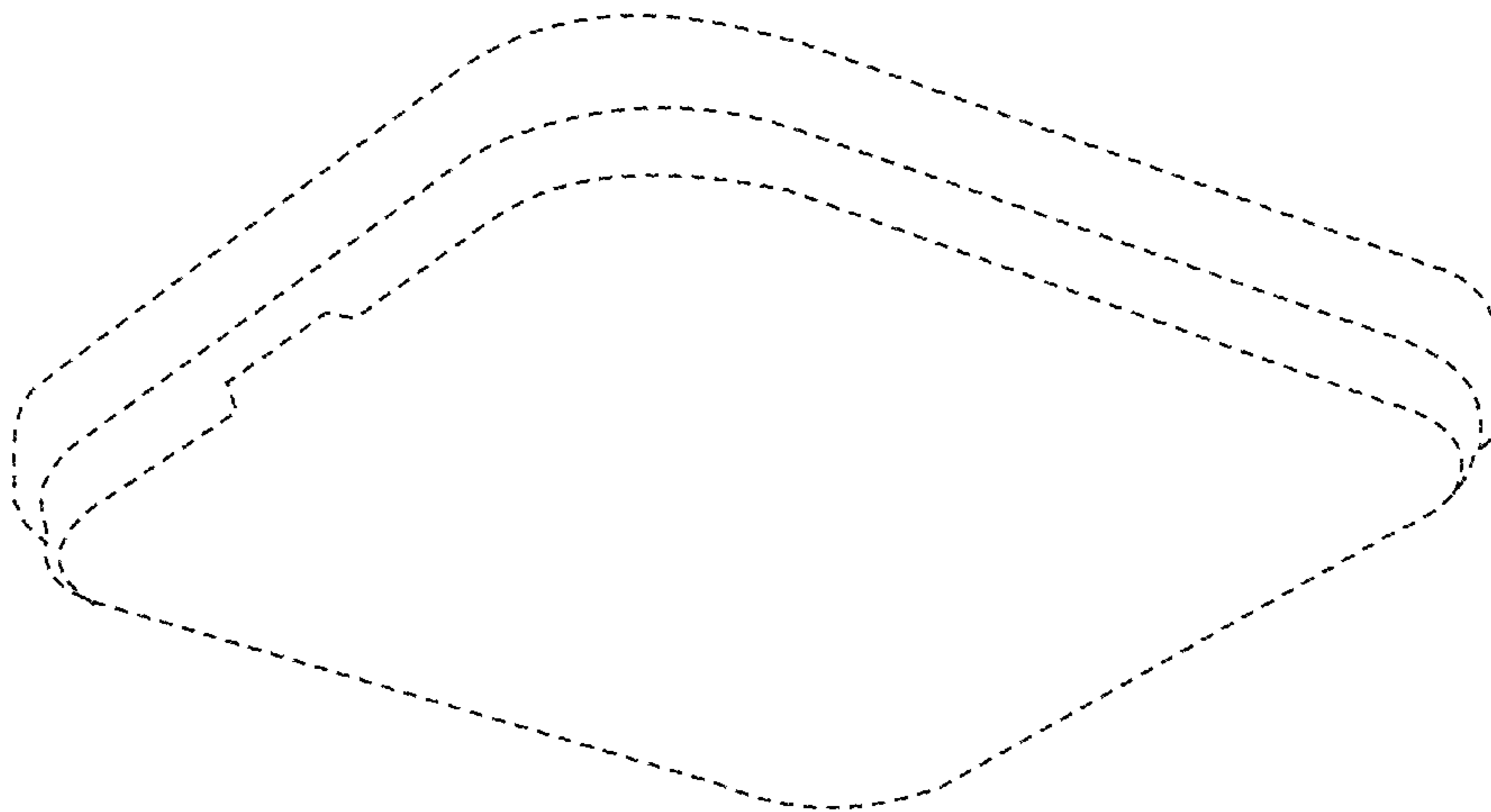

FIG. 60

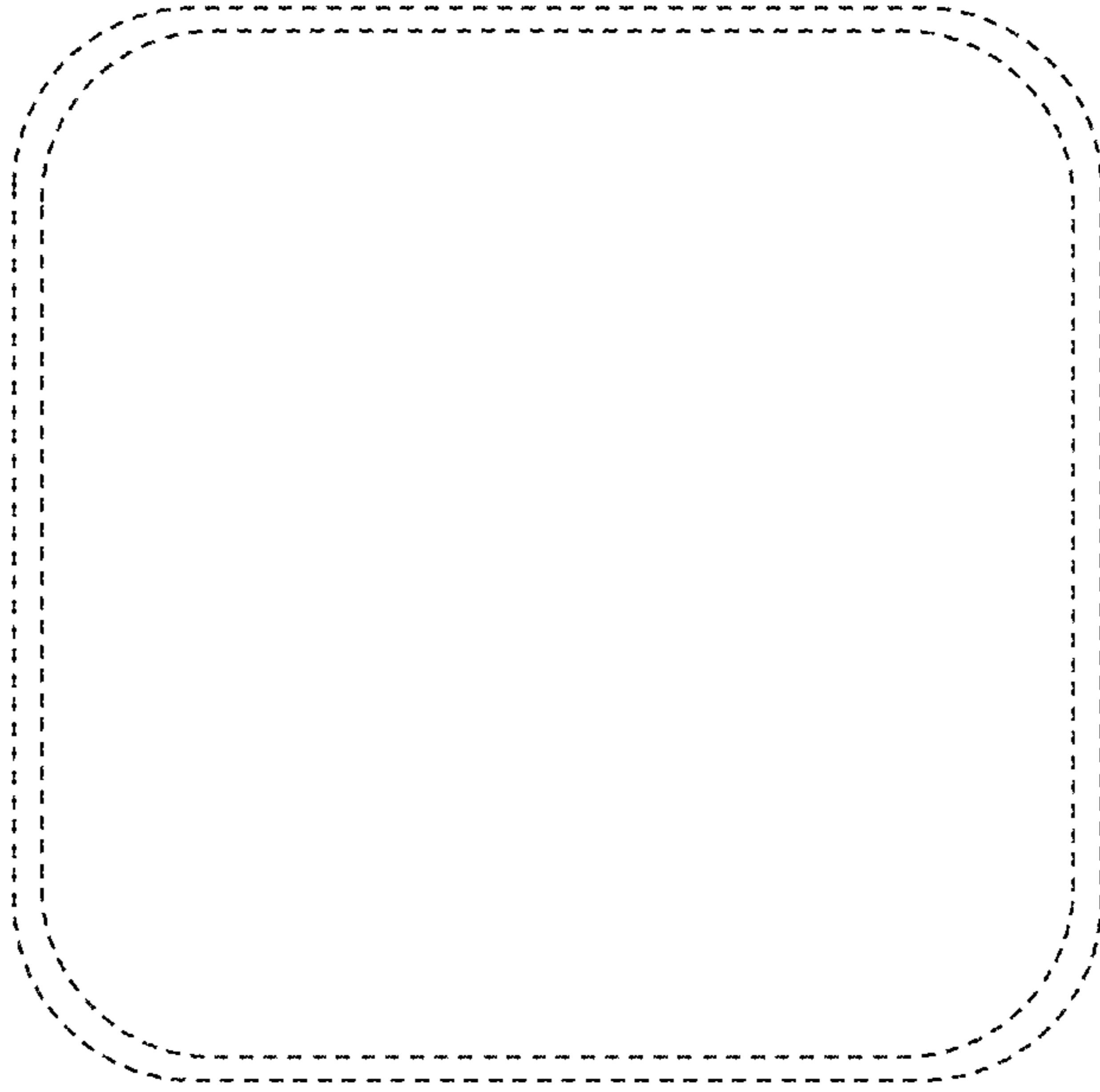

FIG. 61

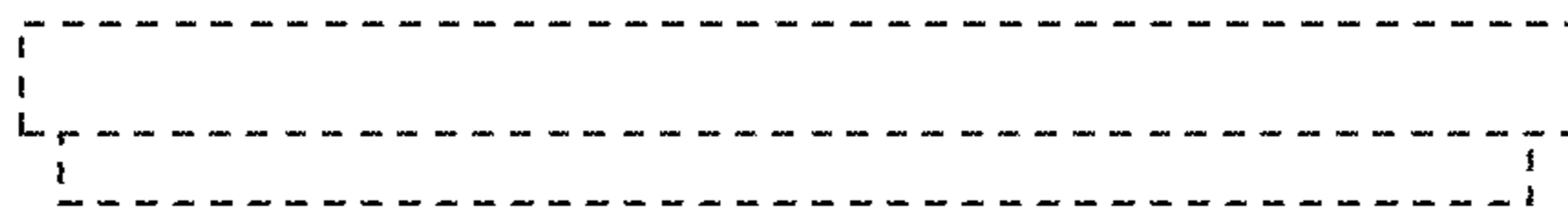

FIG. 62

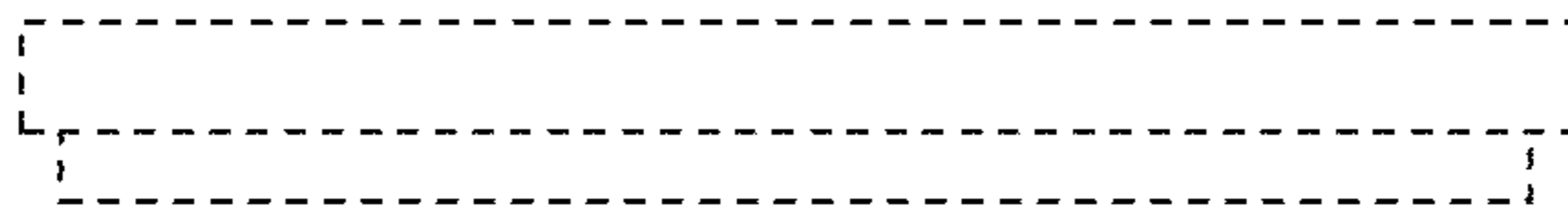

FIG. 63