



US00D948200S

(12) **United States Design Patent**
Zhang

(10) **Patent No.:** **US D948,200 S**

(45) **Date of Patent:** **** Apr. 12, 2022**

(54) **SHOE BUCKLE**

(71) Applicant: **Aijun Zhang**, Guangdong (CN)

(72) Inventor: **Aijun Zhang**, Guangdong (CN)

(**) Term: **15 Years**

(21) Appl. No.: **29/787,550**

(22) Filed: **Jun. 7, 2021**

(51) **LOC (13) Cl.** **02-07**

(52) **U.S. Cl.**
USPC **D2/976**

(58) **Field of Classification Search**
USPC D2/976-978, 923-925, 911; D11/216,
D11/226
CPC A43B 5/0447; A43B 5/0454; F26B 21/04;
A43C 11/16; A63C 10/145; A63C 10/24;
A63B 21/157
See application file for complete search history.

(56) **References Cited**

U.S. PATENT DOCUMENTS

- 4,360,979 A * 11/1982 Spademan A43B 5/0447
36/118.8
- D276,823 S * 12/1984 Mueller D20/32
- D336,972 S * 7/1993 Diaz D2/901
- 5,425,161 A * 6/1995 Schoch A43C 11/165
24/68 SK
- D366,755 S * 2/1996 Abbey D2/962
- D378,320 S * 3/1997 Ganon D2/974
- 5,788,618 A * 8/1998 Joutras A63C 10/145
482/8
- D498,039 S * 11/2004 Choi D2/929
- D515,287 S * 2/2006 Ardissono D2/907
- D519,718 S * 5/2006 Choi D2/898
- D525,421 S * 7/2006 Choi D2/977
- D530,064 S * 10/2006 Choi D2/971
- D594,220 S * 6/2009 McDaniel D2/971
- D667,212 S * 9/2012 Reilly D2/976
- D687,346 S * 8/2013 Della Valle D11/213

- D719,339 S * 12/2014 Lee D2/978
- D743,675 S * 11/2015 Yehudah D2/917
- D878,720 S * 3/2020 Andrews D2/933
- D885,973 S 6/2020 Hardy
- D891,076 S 7/2020 Reilly
- D903,247 S * 12/2020 Kuerbis D2/902
- D903,272 S * 12/2020 Dombrow D2/944

FOREIGN PATENT DOCUMENTS

CN 306344437 * 2/2021

OTHER PUBLICATIONS

Shoe buckles, tineye image date 2021, site visited Feb. 23, 2021,
<https://www.ebay.com/itm/373617240715>.*

* cited by examiner

Primary Examiner — John R Yeh
(74) *Attorney, Agent, or Firm* — ScienBiziP, P.C.

(57) **CLAIM**

The ornamental design for a shoe buckle, as shown and described.

DESCRIPTION

FIG. 1 is a front, right, and top perspective view of a shoe buckle, showing my design.
 FIG. 2 is a front elevation view thereof.
 FIG. 3 is a rear elevation view thereof.
 FIG. 4 is a left side elevation view thereof.
 FIG. 5 is a right side elevation view thereof.
 FIG. 6 is a top plan view thereof.
 FIG. 7 is a bottom plan view thereof; and,
 FIG. 8 is a perspective view of the shoe buckle of FIG. 1 wherein a clasp of the shoe buckle is buttoned up.
 The broken lines shown in the drawings are included for the purpose of illustrating portions of the shoe buckle that form no part of the claimed design.

1 Claim, 8 Drawing Sheets



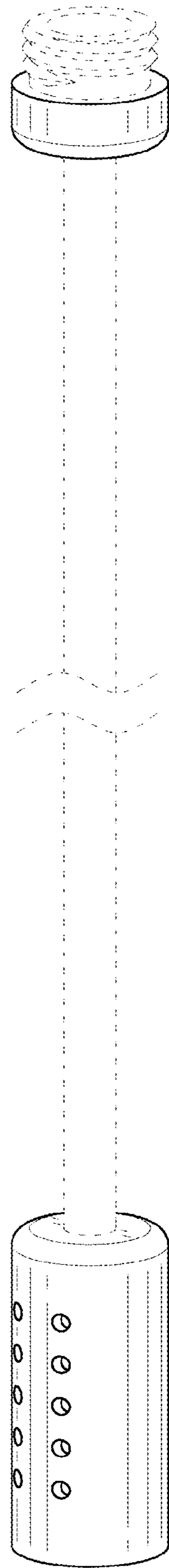

FIG. 1

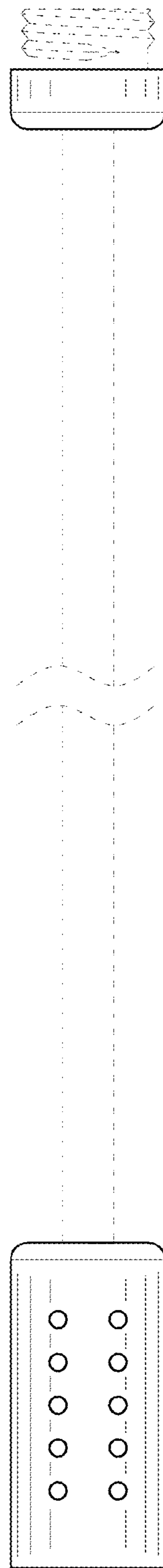

FIG. 2

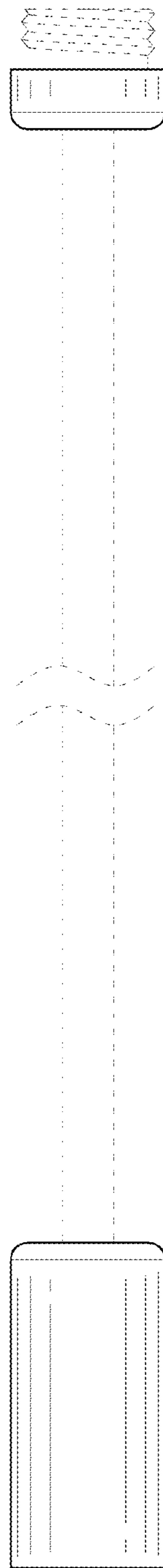

FIG. 3

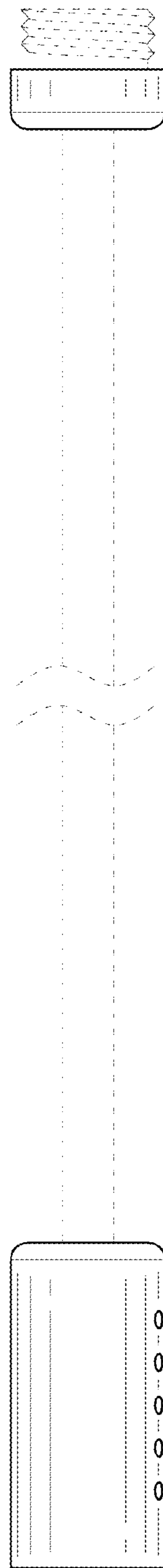

FIG. 4

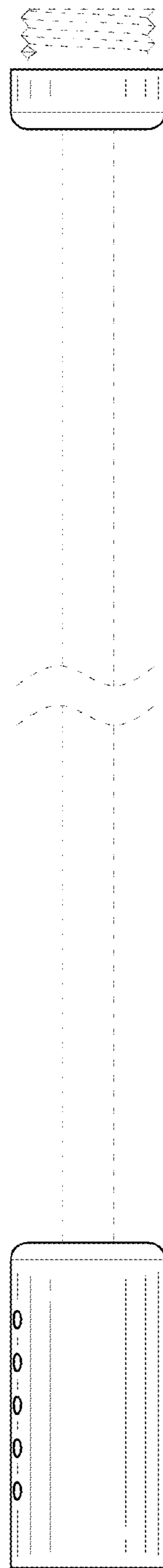

FIG. 5

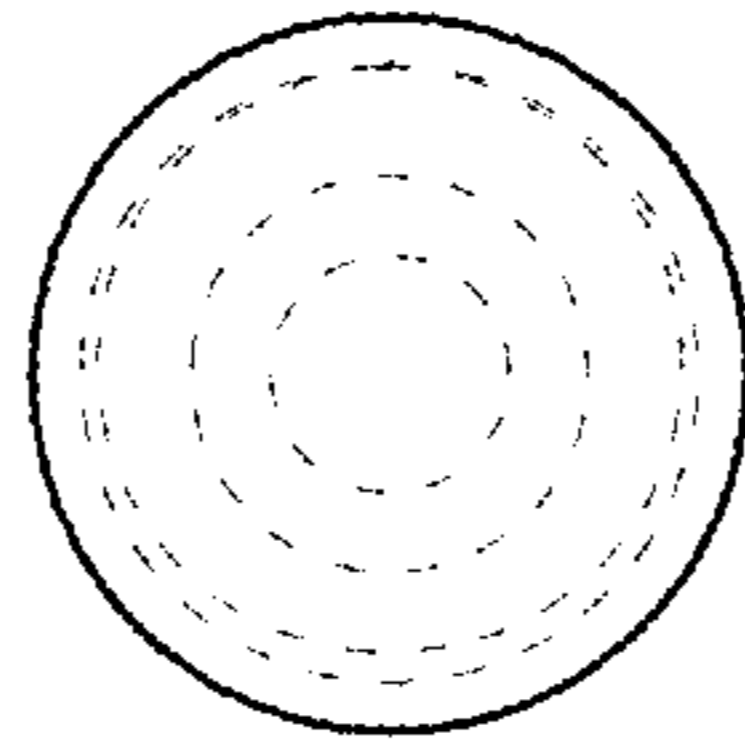

FIG. 6

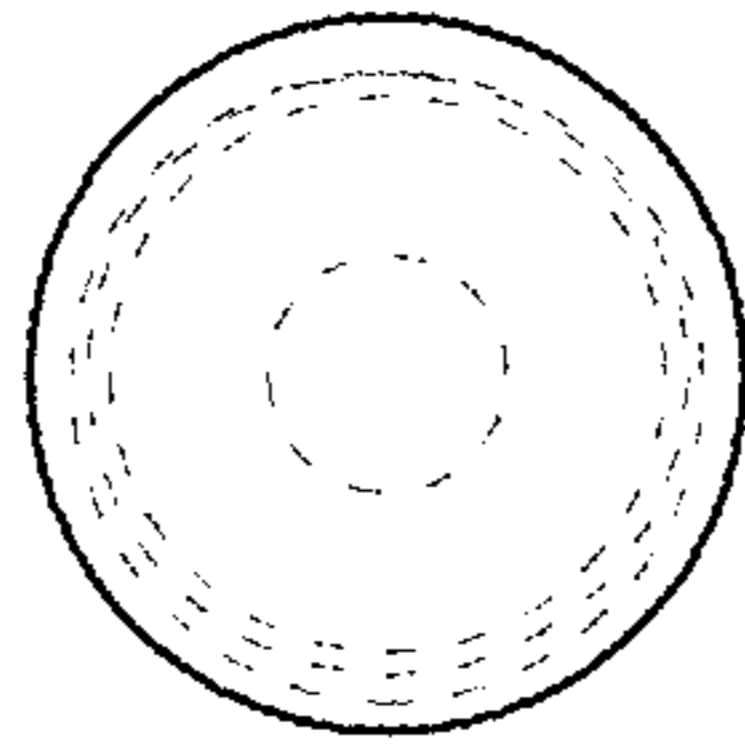

FIG. 7

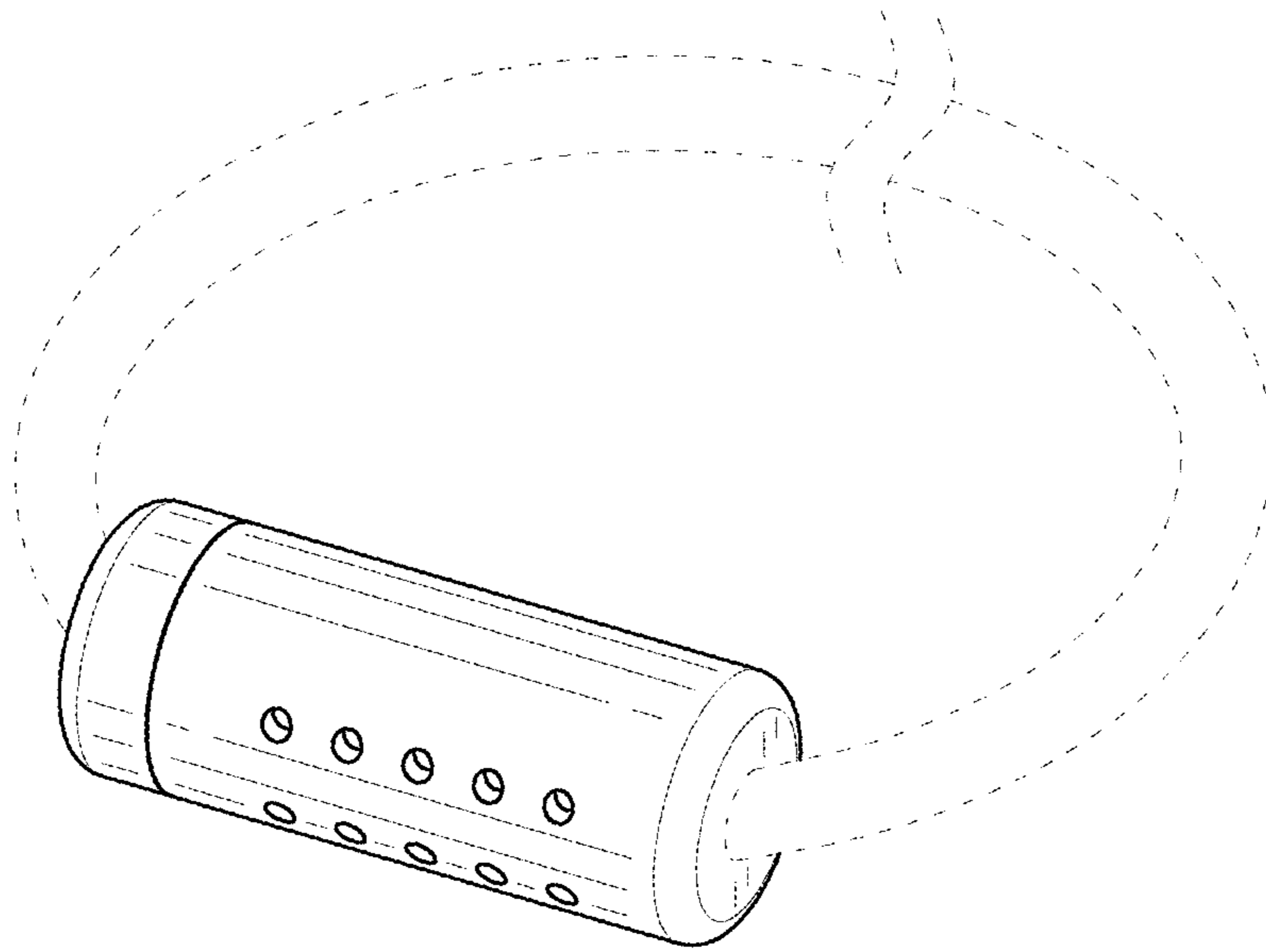

FIG. 8