



US00D948089S

(12) **United States Design Patent** (10) **Patent No.:** **US D948,089 S**
Sakaue (45) **Date of Patent:** **** Apr. 5, 2022**

(54) **FRONT COMBINATION LAMP FOR AN AUTOMOBILE**

(71) Applicant: **TOYOTA JIDOSHA KABUSHIKI KAISHA**, Toyota (JP)

(72) Inventor: **Motoaki Sakaue**, Handa (JP)

(73) Assignee: **TOYOTA JIDOSHA KABUSHIKI KAISHA**

(**) Term: **15 Years**

(21) Appl. No.: **29/738,524**

(22) Filed: **Jun. 18, 2020**

(30) **Foreign Application Priority Data**

Dec. 20, 2019 (JP) 2019-028412

(51) **LOC (13) Cl.** **26-06**

(52) **U.S. Cl.**
USPC **D26/28**

(58) **Field of Classification Search**
USPC D26/28, 29, 30, 31, 32, 33, 34, 35, 36
CPC F21S 41/14; F21S 41/60; F21V 14/01;
F21V 35/00; B65D 41/04; A47G 23/03
See application file for complete search history.

(56) **References Cited**

U.S. PATENT DOCUMENTS

D831,866 S	*	10/2018	Lin	D26/28
D889,697 S	*	7/2020	Tovey	D26/28
D923,827 S	*	6/2021	Loisch	D26/28
D923,828 S	*	6/2021	Loisch	D26/28
D924,450 S	*	7/2021	Fukunaga	D26/28
D925,795 S	*	7/2021	Yang	D26/28
D932,068 S	*	9/2021	Fukunaga	D26/28

OTHER PUBLICATIONS

“ECCPP Headlight Assembly for Toyota Camry”, by ECCPP, published on Oct. 31, 2020 by Amazon, first visited on Nov. 3, 2021

via URL: <<https://www.amazon.com/ECCPP-Headlight-Assembly-2012-2014-Headlamps/dp/B08MC72ZTH>> (Year: 2020).*
LONGDING Headlights Assemblies for Toyota Camry, by LONGDING, published on Jul. 30, 2021 by Amazon, first visited on Nov. 3, 2021 via URL: <<https://www.amazon.com/LONGDING-Toyota-Camry-XV70-XSE/dp/B09BJG4PJ>> (Year: 2021).*
“Car headlight 3 lens headlamp for toyota camry”, by Danyang Xia Tian Auto Parts Company, published by Alibaba, first visited on Nov. 3, 2021 via URL: <https://www.alibaba.com/product-detail/car-headlight-3-lens-headlamp-for_1600174272350.html>.*
netcarshow.com, Toyota RAV4 Adventure (2019), <https://www.netcarshow.com/toyota/2019-rav4_adventure/>, available as early as Mar. 18, 2019.
netcarshow.com, Toyota Supra (2020), <<https://www.netcarshow.com/toyota/2020-supra/>>, available as early as Mar. 18, 2019.

* cited by examiner

Primary Examiner — Marissa J Cash
Assistant Examiner — Nishaad Sebastian Lorengo
(74) *Attorney, Agent, or Firm* — Saidman DesignLaw Group, LLC

(57) **CLAIM**

The ornamental design for a front combination lamp for an automobile, as shown and described.

DESCRIPTION

FIG. 1 is a perspective view of a front combination lamp for an automobile showing my new design;
FIG. 2 is a front view thereof;
FIG. 3 is a rear view thereof;
FIG. 4 is a right side view thereof;
FIG. 5 is a left side view thereof;
FIG. 6 is a top view thereof; and,
FIG. 7 is a bottom view thereof.

1 Claim, 7 Drawing Sheets

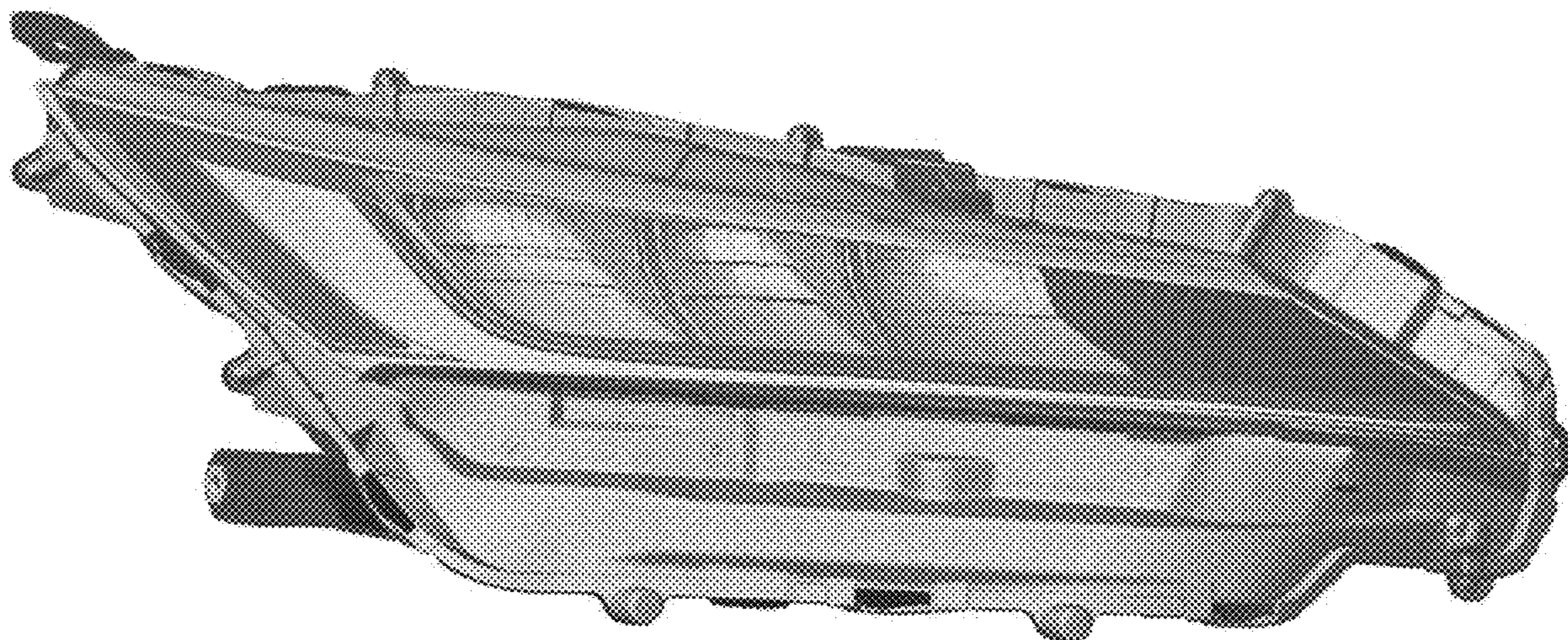

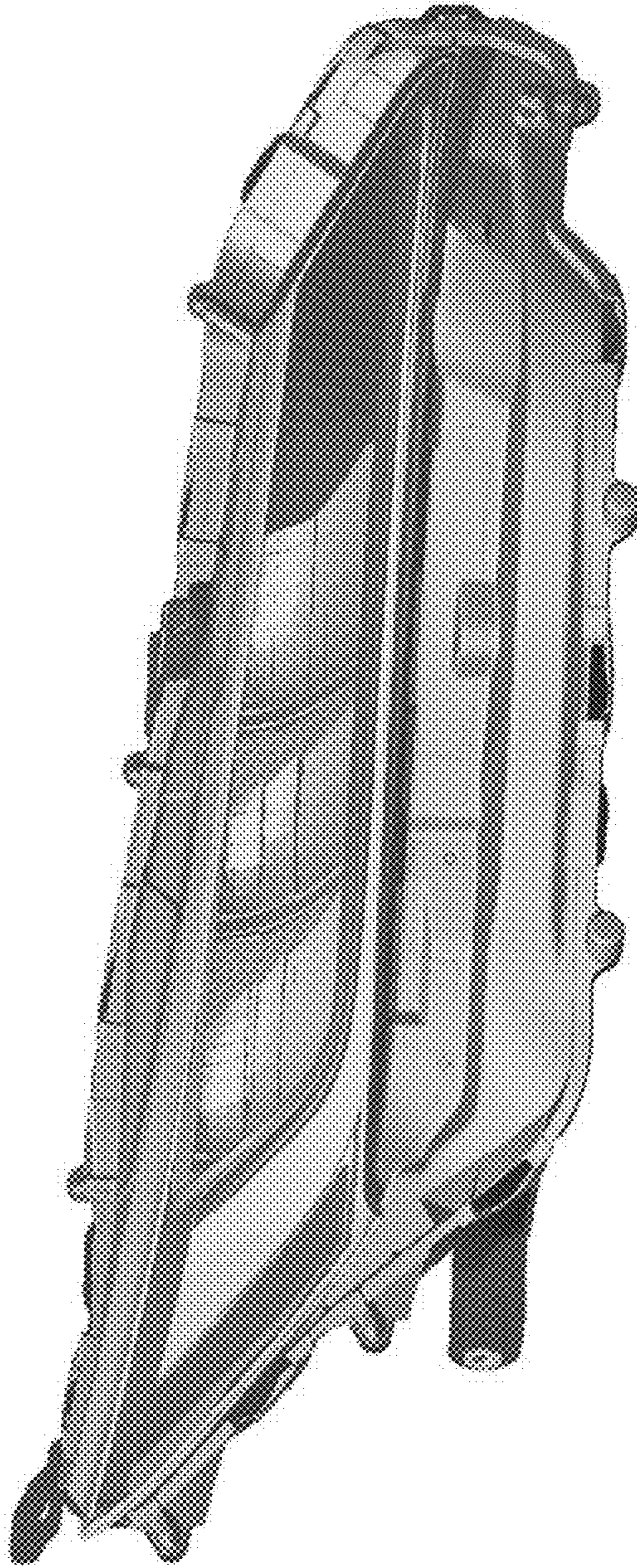

FIG. 1

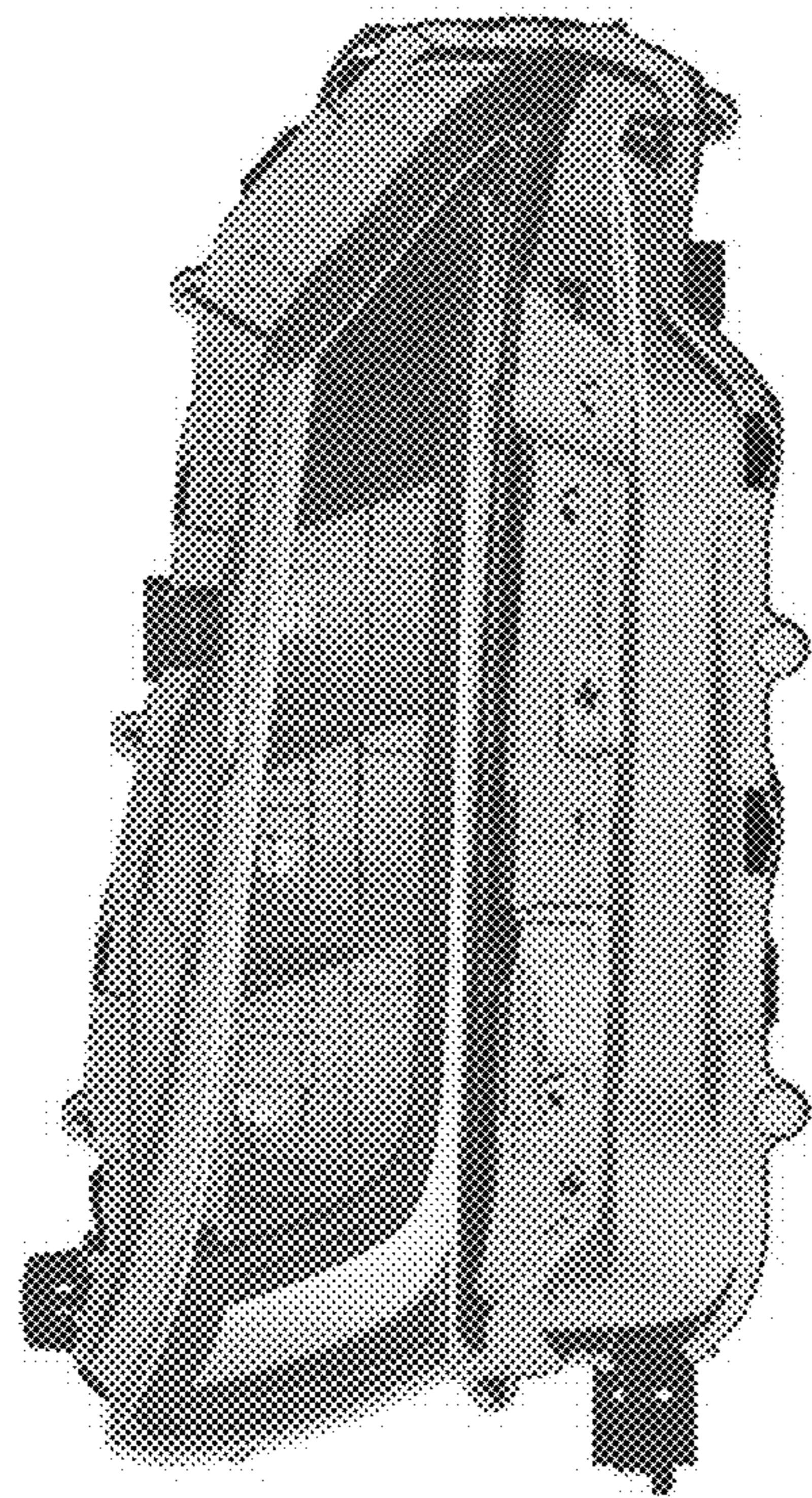

FIG. 2

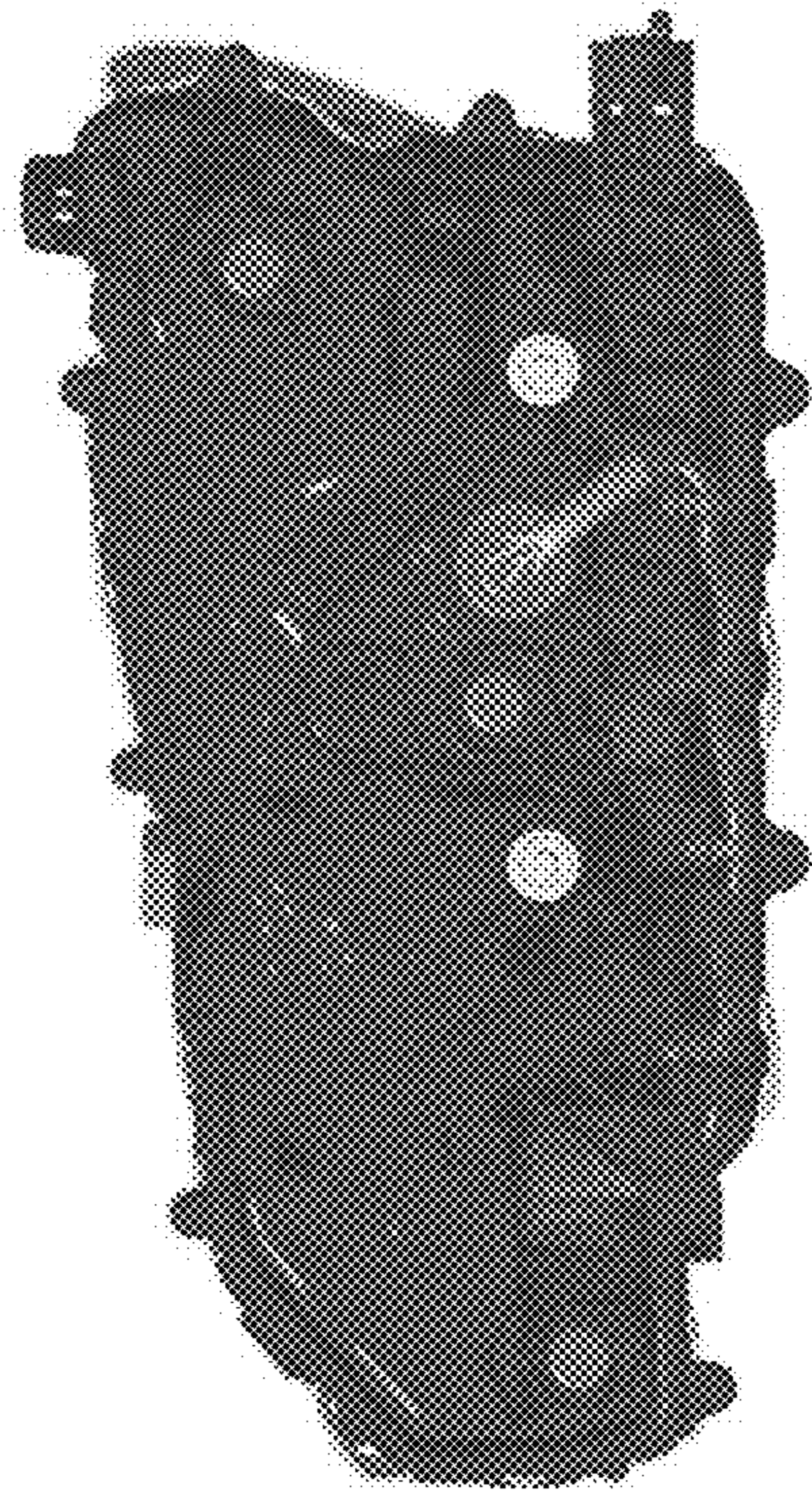

FIG. 3



FIG. 4

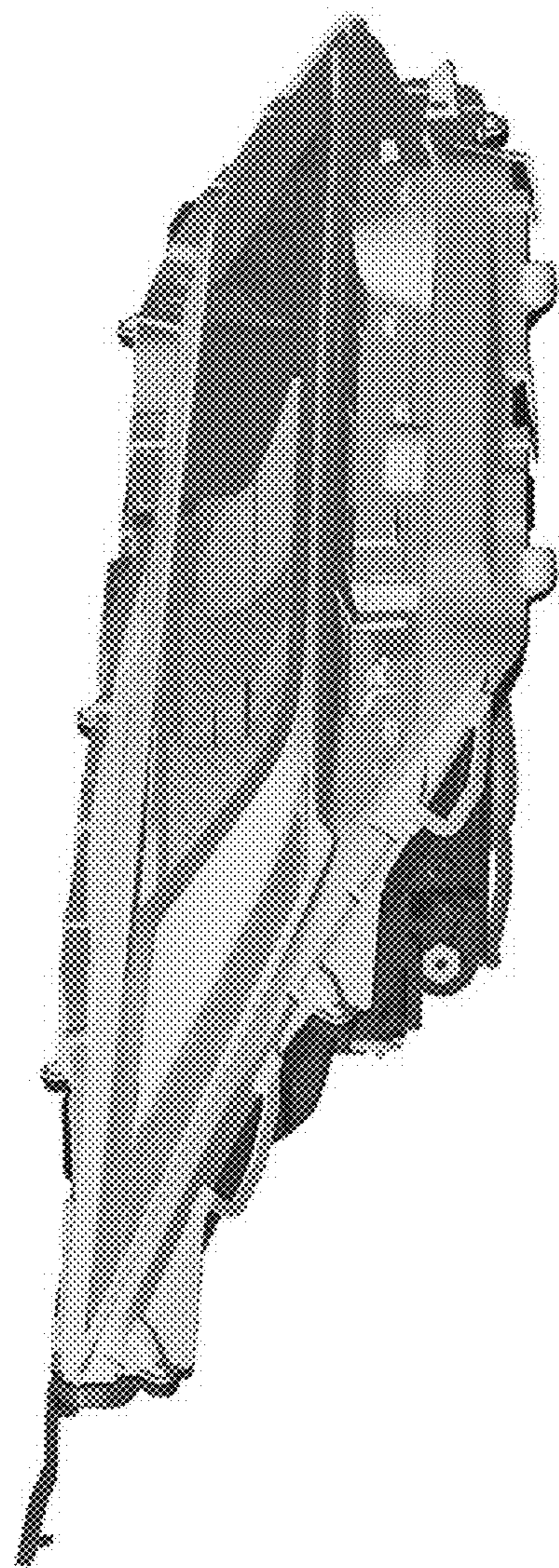

FIG. 5

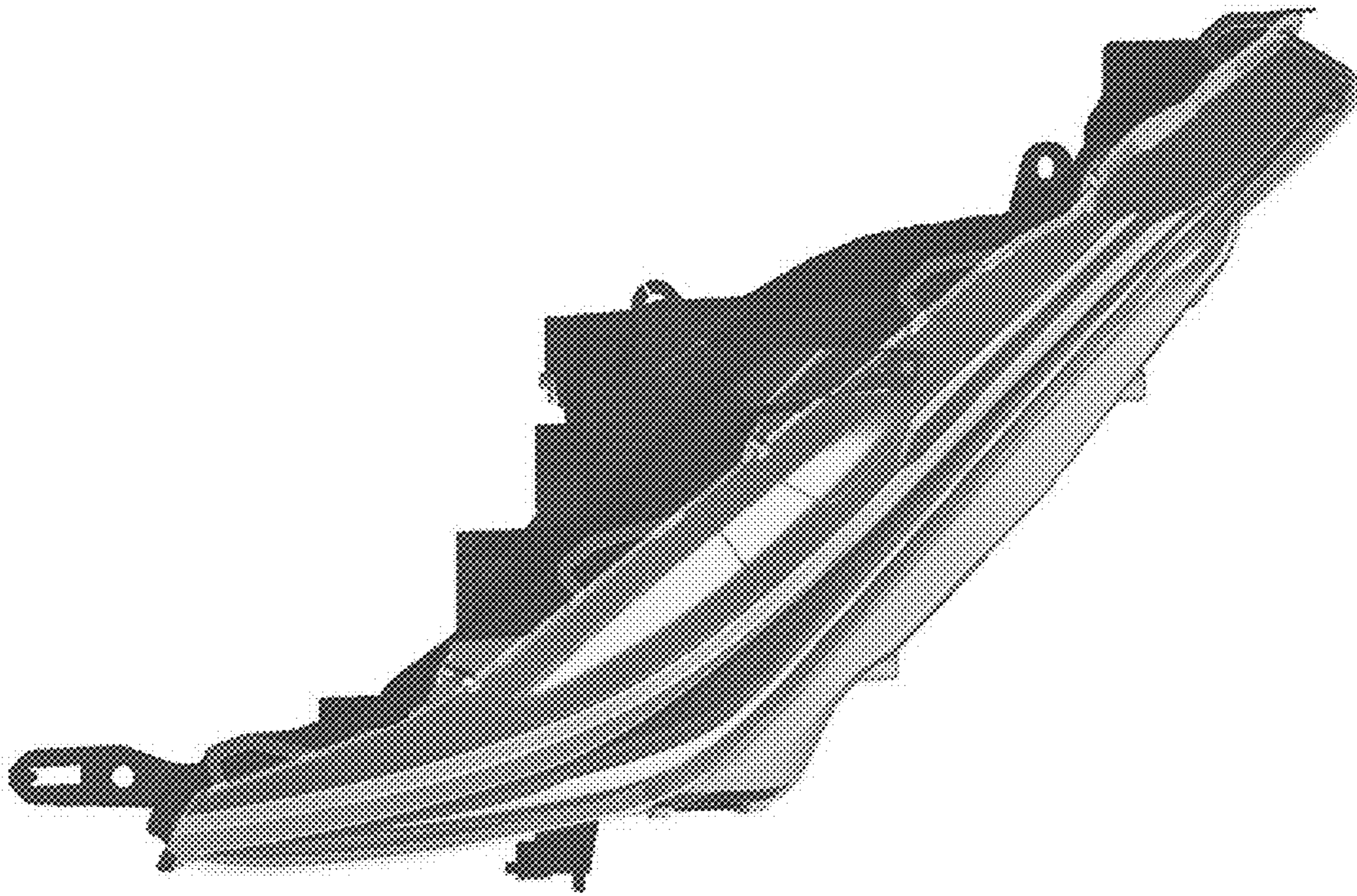

FIG. 6

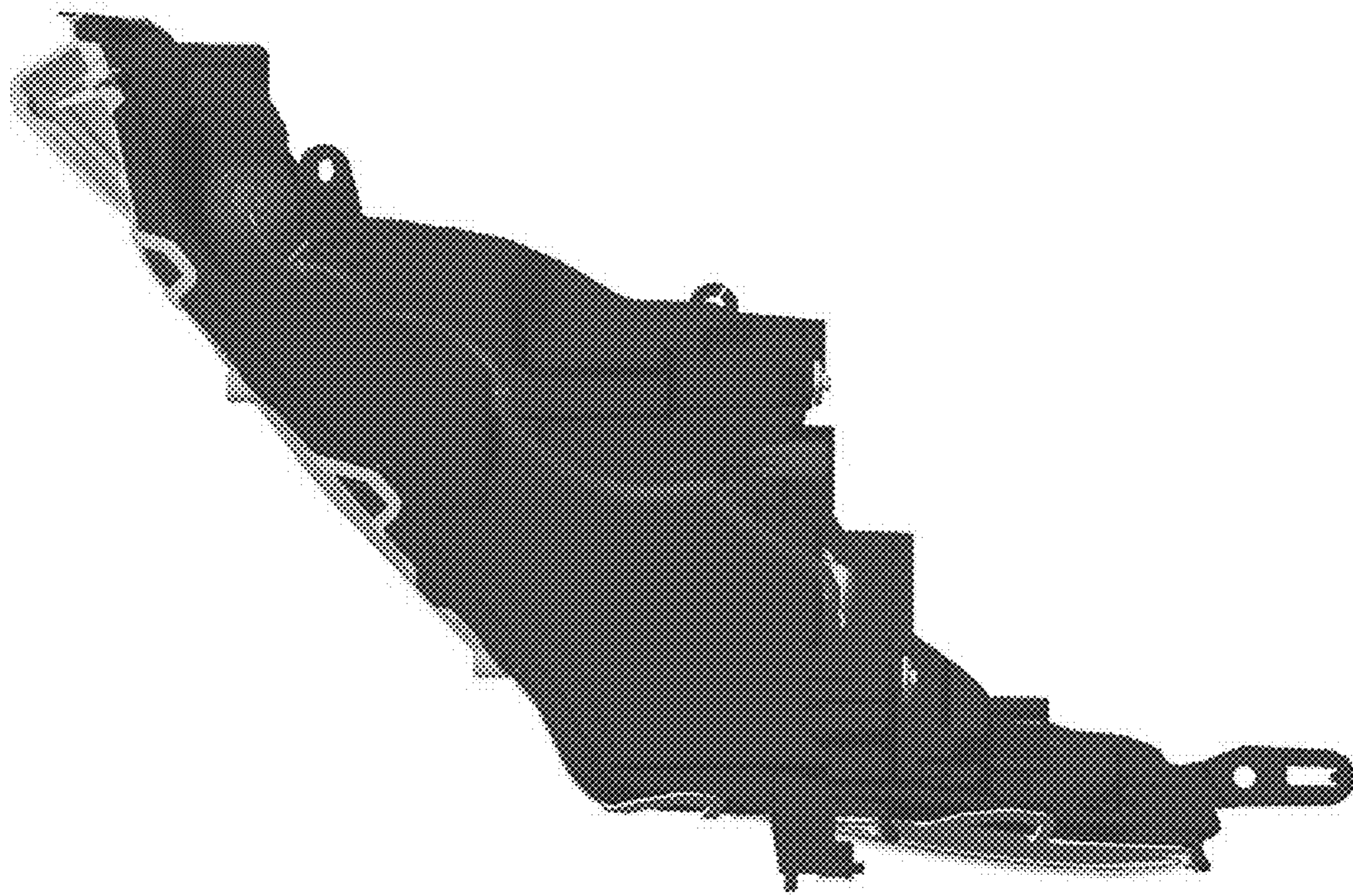

FIG. 7