



US00D948039S

(12) **United States Design Patent** (10) **Patent No.:** **US D948,039 S**
Dastmalchi et al. (45) **Date of Patent:** **** Apr. 5, 2022**

(54) **SERUM PEN**
(71) Applicant: **Vitagoods, LLC**, Newport Beach, CA (US)
(72) Inventors: **Alex Dastmalchi**, Newport Coast, CA (US); **Olga Avila**, Corona Del Mar, CA (US); **Samuel Wu**, Chino Hills, CA (US); **Toni Battaglia**, Newport Beach, CA (US)

D568,988 S * 5/2008 Galbraith D24/112
D573,253 S * 7/2008 Gonzales D24/113
D585,997 S * 2/2009 Adam D24/107
D588,696 S * 3/2009 Mantle D24/144
D603,970 S * 11/2009 Ball D24/200
D621,950 S * 8/2010 Seki D24/209
7,785,026 B2 * 8/2010 Eng A45D 34/04
401/37
D663,836 S * 7/2012 Ruiz, Sr. D24/133
D676,546 S * 2/2013 Lovell D24/113
(Continued)

(73) Assignee: **Vitagoods, LLC**, Newport Beach, CA (US)

(**) Term: **15 Years**

(21) Appl. No.: **29/734,103**

(22) Filed: **May 8, 2020**

(51) **LOC (13) Cl.** **24-02**

(52) **U.S. Cl.**
USPC **D24/133; D24/113**

(58) **Field of Classification Search**
USPC D24/104, 107, 112-114, 117-119, 127, D24/130, 133, 144, 146, 147, 186, 200, D24/209, 210, 215; 604/181, 187, 272; 606/131; D28/9, 52-54, 58
CPC A61M 5/165; A61M 5/36; A61M 5/38; A61M 5/24; A61M 35/003; A61M 35/00; A45D 33/00; A45D 42/00

See application file for complete search history.

(56) **References Cited**

U.S. PATENT DOCUMENTS

D287,879 S * 1/1987 Braxton D24/144
5,984,940 A * 11/1999 Davis A61B 5/15186
606/181
6,022,366 A * 2/2000 Schraga A61B 5/150022
606/181
D546,448 S * 7/2007 Oi D24/133

OTHER PUBLICATIONS

[Aqua Pen Professional Microneedle Derma Pen Automatic Serum Applicator], Walmart.com, Date First Available: 2019 [online], Customer Review Oldest Date: Nov. 16, 2019 [online], site visited: [Dec. 9, 2021], URL: <https://www.walmart.com/ip/Aqua-Pen-Professional-Microneedle-Derma-Pen-Automatic-Serum-Applicator/148078736> (Year: 2019).*

Primary Examiner — Jonathan J Han

Assistant Examiner — Amanda J Berlinski

(74) *Attorney, Agent, or Firm* — Avyno Law P.C.

(57) **CLAIM**

We claim the ornamental design for a serum pen, as shown and described.

DESCRIPTION

FIG. 1 is a front perspective view of a serum pen.
FIG. 2 is a front elevation view of the serum pen of FIG. 1.
FIG. 3 is a back elevation view of the serum pen of FIG. 1.
FIG. 4 is a left side elevation view of the serum pen of FIG. 1.
FIG. 5 is a right side elevation view of the serum pen of FIG. 1.
FIG. 6 is a top plan view of the serum pen of FIG. 1; and,
FIG. 7 is a bottom plan view of the serum pen of FIG. 1.

1 Claim, 4 Drawing Sheets

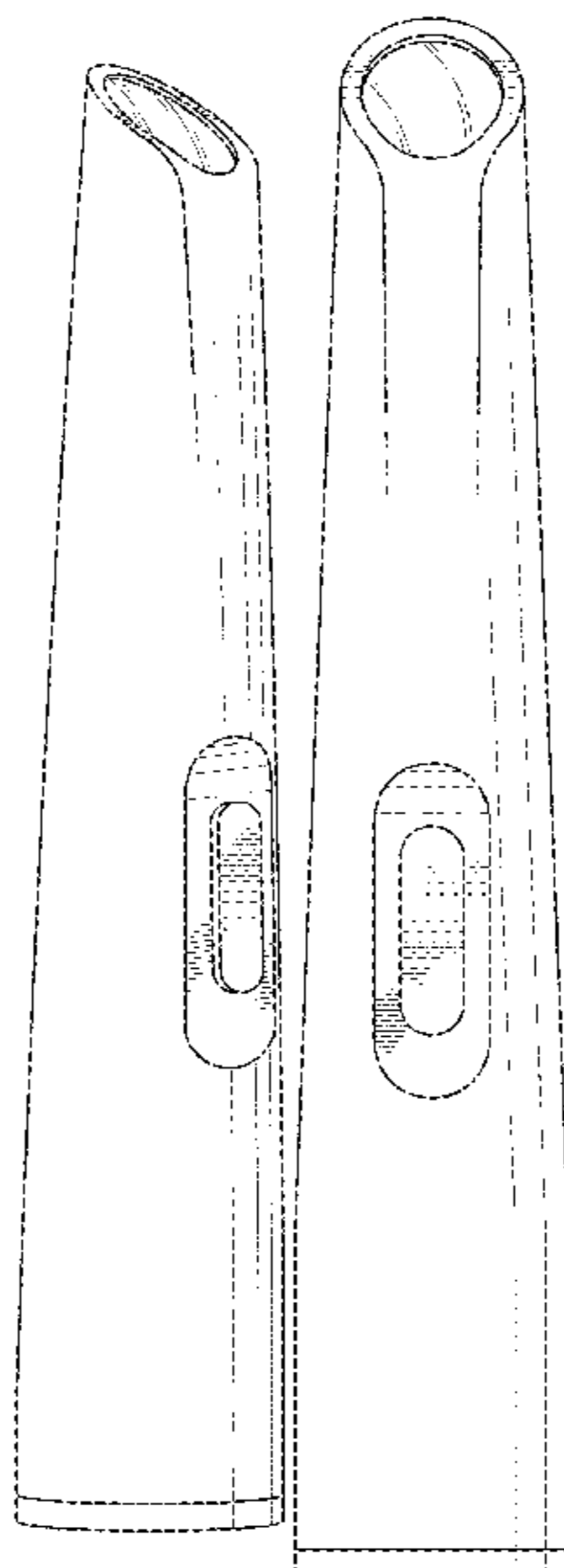

(56)

References Cited

U.S. PATENT DOCUMENTS

| | | | | | | | |
|--------------|---------|----------------------|---------------|-------------------|---------|----------------|--------------|
| D678,783 S * | 3/2013 | Wilcox | A61B 5/15186 | D925,035 S * | 7/2021 | Zhang | D24/144 |
| | | | | D930,177 S * | 9/2021 | Wang | D28/51 |
| D696,770 S * | 12/2013 | Schneider | A61B 5/150022 | D931,128 S * | 9/2021 | Li | D28/54 |
| | | | | D935,030 S * | 11/2021 | De Klein | A61M 35/00 |
| D742,003 S * | 10/2015 | Tasar | D24/146 | 2007/0217199 A1 * | 9/2007 | Adam | A61N 5/0616 |
| D759,261 S * | 6/2016 | Son | D24/215 | | | | 362/276 |
| D759,310 S * | 6/2016 | Van Maanen | D28/54 | 2015/0045729 A1 * | 2/2015 | Denzer | A61J 1/065 |
| D779,670 S * | 2/2017 | Krystyniak | D24/146 | | | | 604/110 |
| D794,194 S * | 8/2017 | Schuerg | D24/144 | 2015/0051620 A1 * | 2/2015 | Presser | A61B 17/54 |
| D797,287 S * | 9/2017 | de Albuquerque | D24/146 | | | | 606/131 |
| D850,638 S * | 6/2019 | Cha | D24/200 | 2015/0073438 A1 * | 3/2015 | Levy | A45D 44/22 |
| D893,021 S * | 8/2020 | Dyer | D24/113 | | | | 606/131 |
| D895,828 S * | 9/2020 | Marshall | D24/215 | 2015/0246180 A1 * | 9/2015 | Fenlon | A61M 5/3158 |
| D898,286 S * | 10/2020 | Khubani | D28/51 | | | | 604/192 |
| D912,263 S * | 3/2021 | Chen | D24/214 | 2016/0106468 A1 * | 4/2016 | Jansen | A61B 17/54 |
| D914,898 S * | 3/2021 | Britt | D24/200 | | | | 606/131 |
| D924,421 S * | 7/2021 | Luo | D24/215 | 2018/0264196 A1 * | 9/2018 | Fabien | A61M 5/326 |
| | | | | 2021/0113776 A1 * | 4/2021 | Hopkins | A61M 5/31511 |
| | | | | 2021/0213472 A1 * | 7/2021 | Cheng | A61M 35/00 |

* cited by examiner

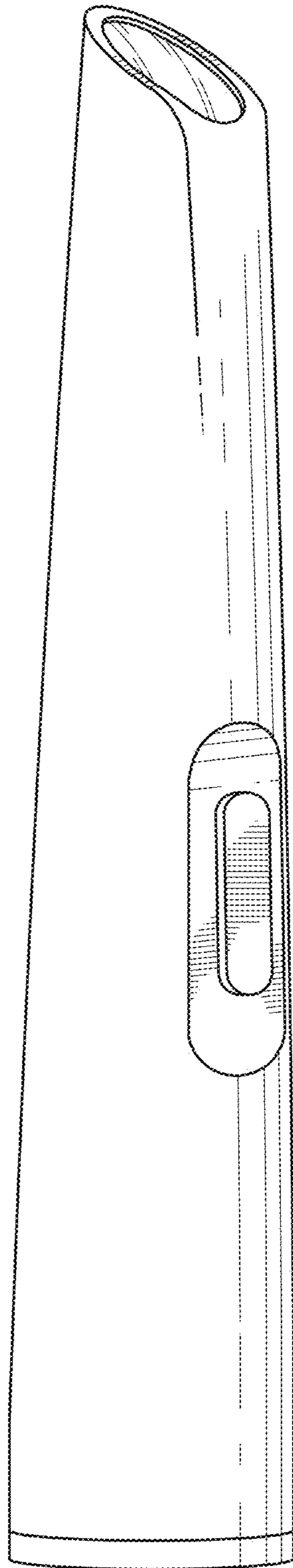

FIG. 1

FIG. 2

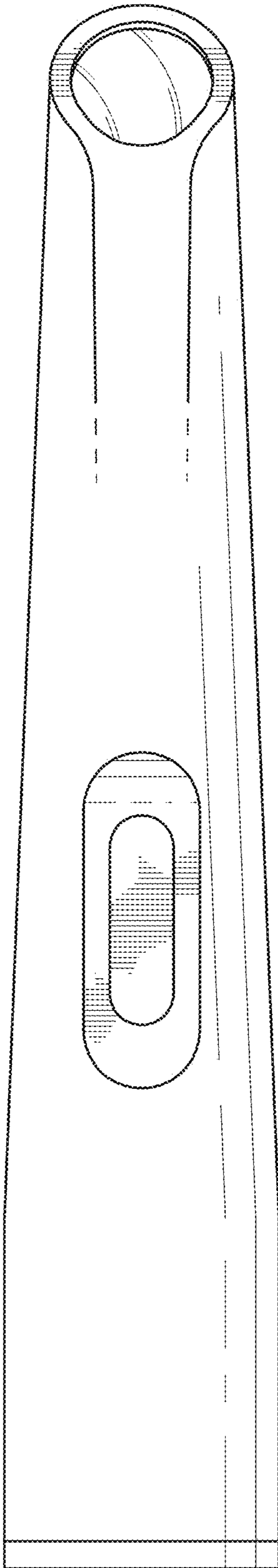

FIG. 3

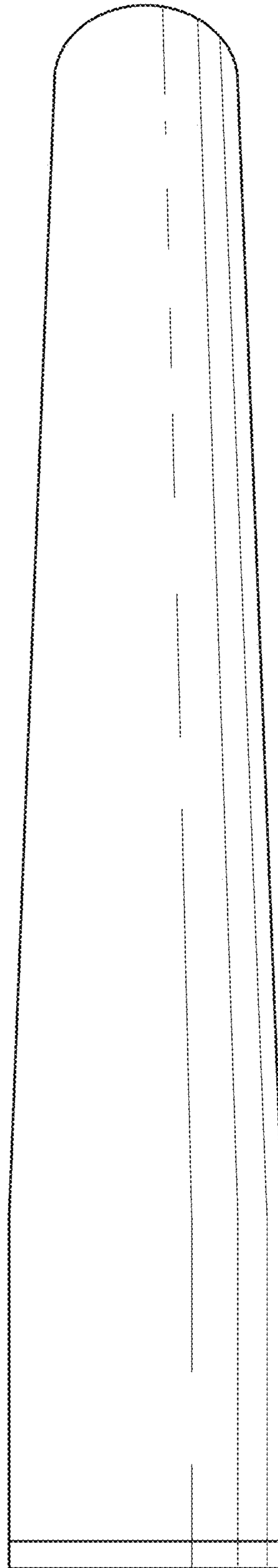

FIG. 4

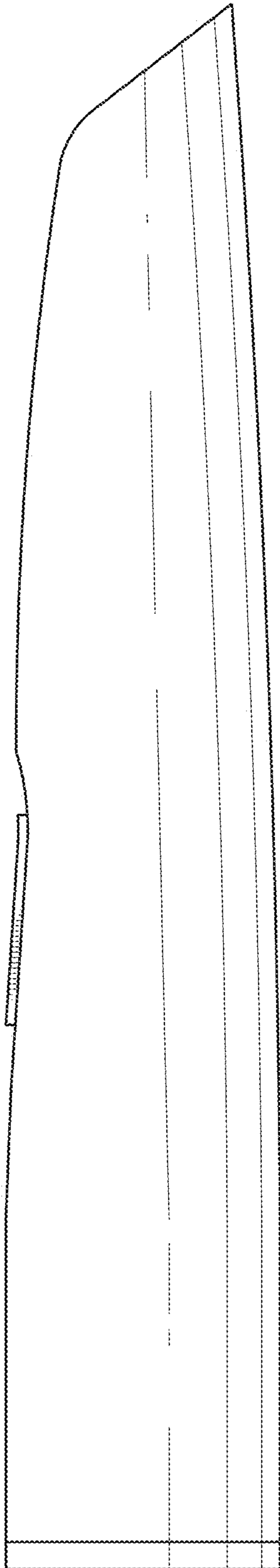
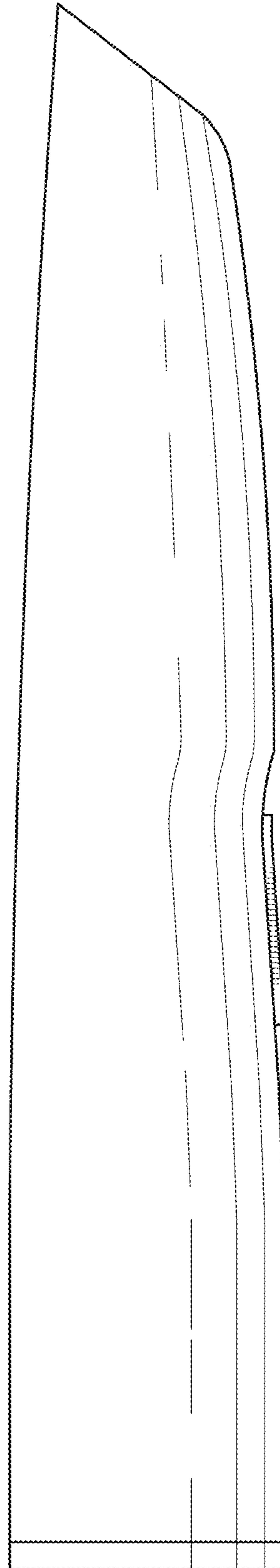

FIG. 5



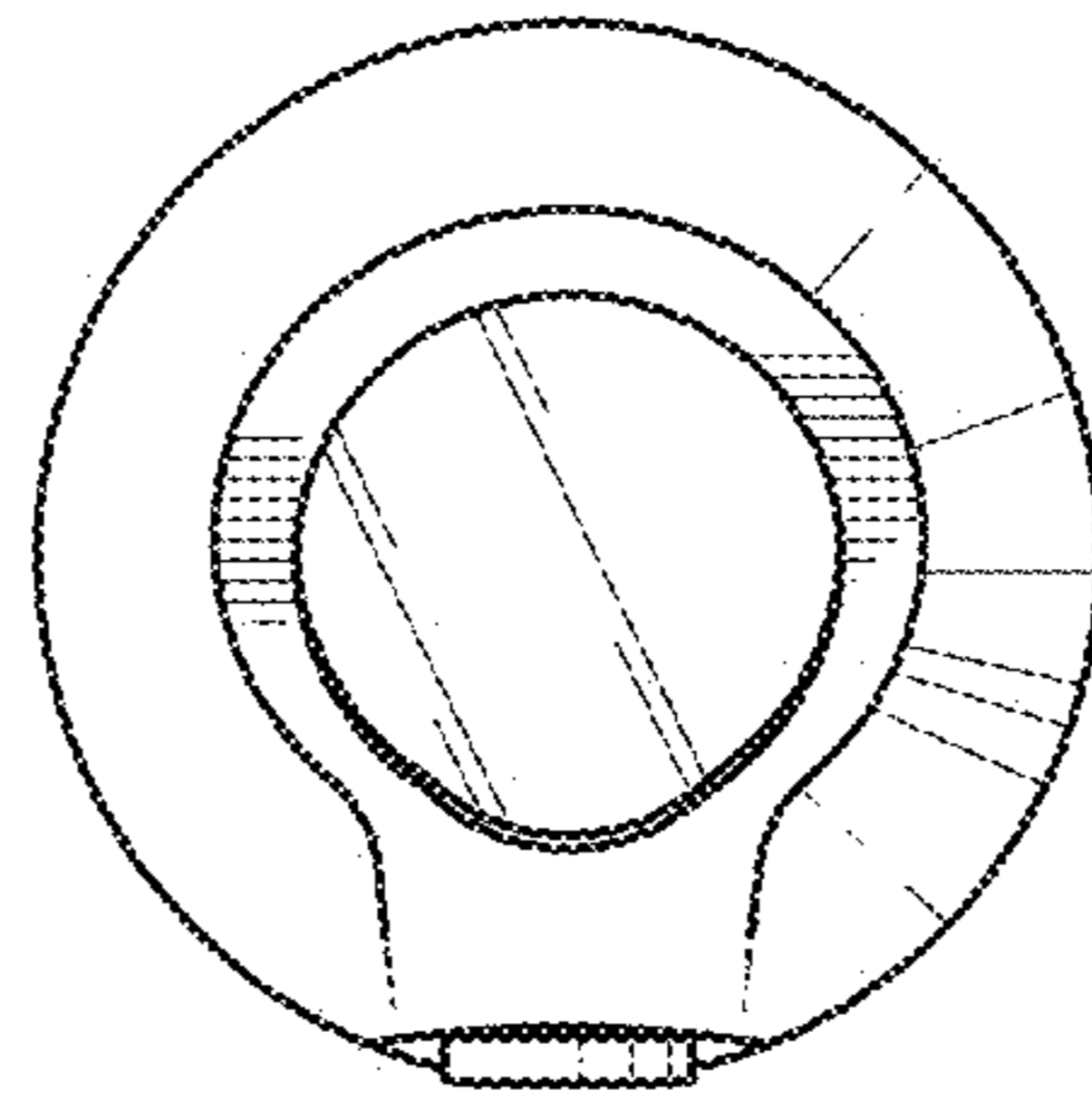

FIG. 6

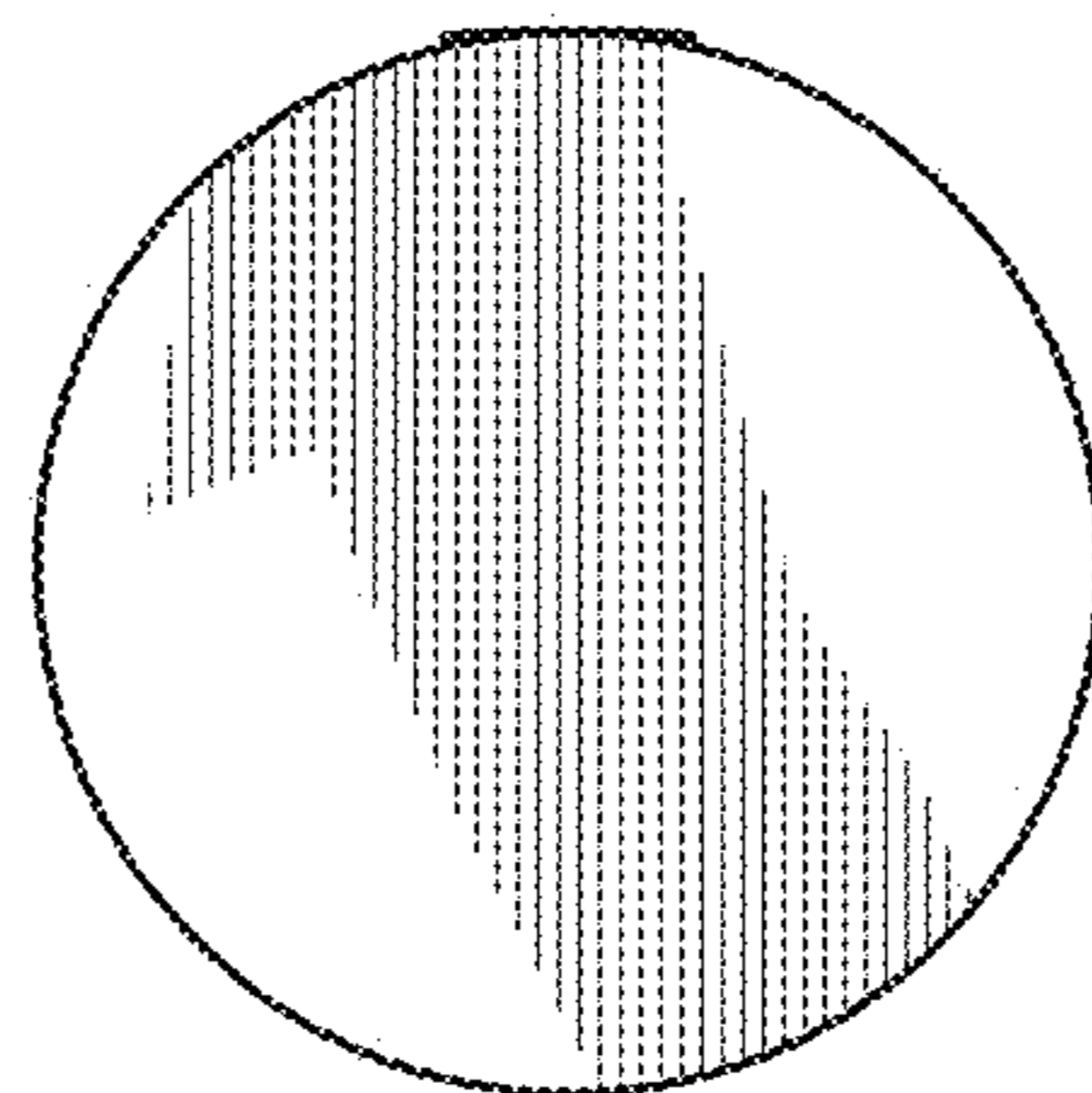

FIG. 7