



US00D948035S

(12) **United States Design Patent** (10) **Patent No.:** **US D948,035 S**
Tiekenheinrich (45) **Date of Patent:** **** Apr. 5, 2022**

(54) **CANNULAE**
(71) Applicant: **Sulzer Mixpac AG**, Haag (CH)
(72) Inventor: **Lars Tiekenheinrich**, Schönberg (DE)
(73) Assignee: **SULZER MIXPAC AG**, Haag (CH)
(**) Term: **15 Years**

D363,985 S * 11/1995 Van Hovel D24/111
D556,320 S * 11/2007 Boclet D24/114
D702,830 S * 4/2014 Hannah D24/108
D733,908 S * 7/2015 Eckstein D24/220
D734,490 S * 7/2015 Eckstein D24/220
D774,908 S * 12/2016 Eckstein D9/447
D794,177 S * 8/2017 Lebedenko D24/112
D812,219 S * 3/2018 Wang D24/111
D833,610 S * 11/2018 Pieroni D24/152
D872,852 S * 1/2020 Mechor D24/108
D884,877 S * 5/2020 Fritze D24/112

(21) Appl. No.: **29/707,411**
(22) Filed: **Sep. 27, 2019**

* cited by examiner

(30) **Foreign Application Priority Data**
Mar. 28, 2019 (EM) 006350088-0001
Mar. 28, 2019 (EM) 006350088-0002
Mar. 28, 2019 (EM) 006350088-0003
Mar. 28, 2019 (EM) 006350088-0004

Primary Examiner — Nathan M Johnston
(74) *Attorney, Agent, or Firm* — Global IP Counselors, LLP

(51) **LOC (13) Cl.** **24-02**
(52) **U.S. Cl.**
USPC **D24/112**

(57) **CLAIM**

The ornamental design for a cannulae, as shown and described.

(58) **Field of Classification Search**
USPC D24/127–131, 112–114, 133, 186;
606/181, 185; 604/264, 523–528, 272,
604/187, 158, 164.01–164.11, 181, 184,
604/227; 600/101, 139, 143;
128/200.24, 207.14, 207.15
CPC A61M 25/00; A61M 39/00; A61M 27/00;
A61M 25/0043; A61M 25/0067; A61M
25/0097; A61F 2/958
See application file for complete search history.

DESCRIPTION

FIG. 1 is a front perspective view of a cannulae in accordance with a first embodiment of my new design;
FIG. 2 is a left side view thereof;
FIG. 3 is a right side view thereof;
FIG. 4 is a front view thereof;
FIG. 5 is a rear view thereof;
FIG. 6 is a top view thereof;
FIG. 7 is a bottom view thereof; and,
FIG. 8 is a back perspective view thereof.
The broken lines show portions of the cannulae that form no part of the claimed design.

(56) **References Cited**
U.S. PATENT DOCUMENTS
2,263,219 A * 11/1941 Lybarger A61H 21/00
601/93
D304,857 S * 11/1989 Nordin D24/152

1 Claim, 7 Drawing Sheets

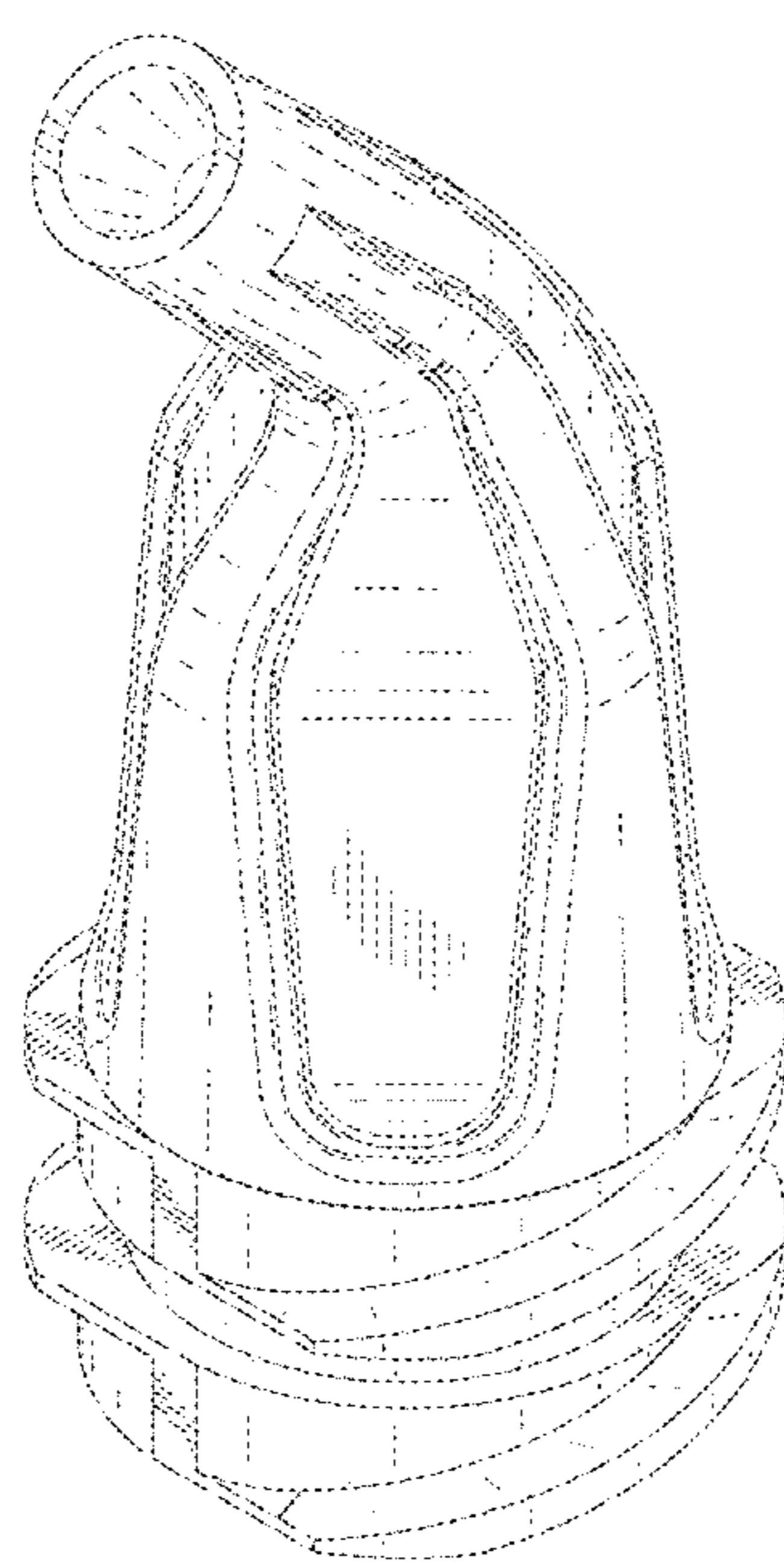

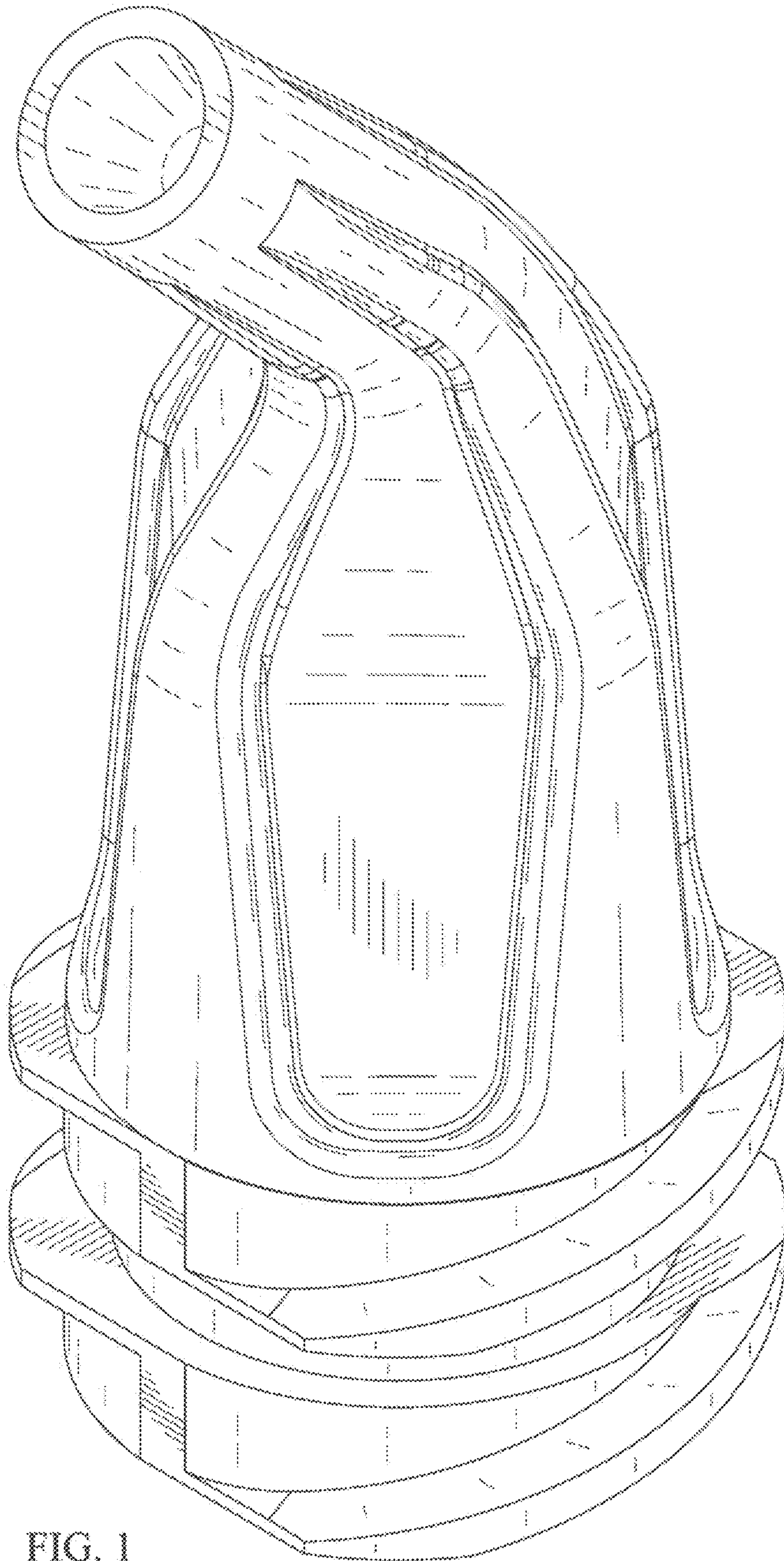

FIG. 1

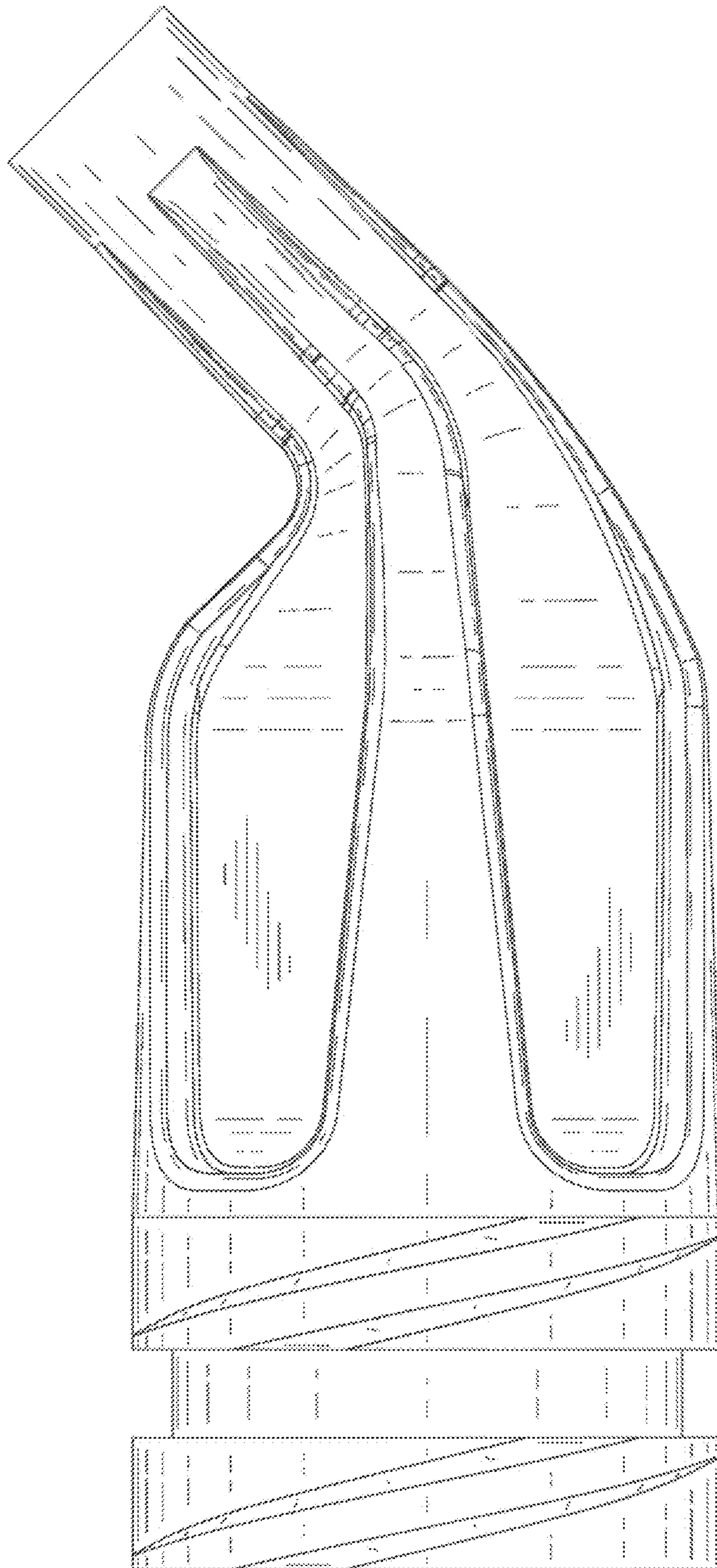

FIG. 2

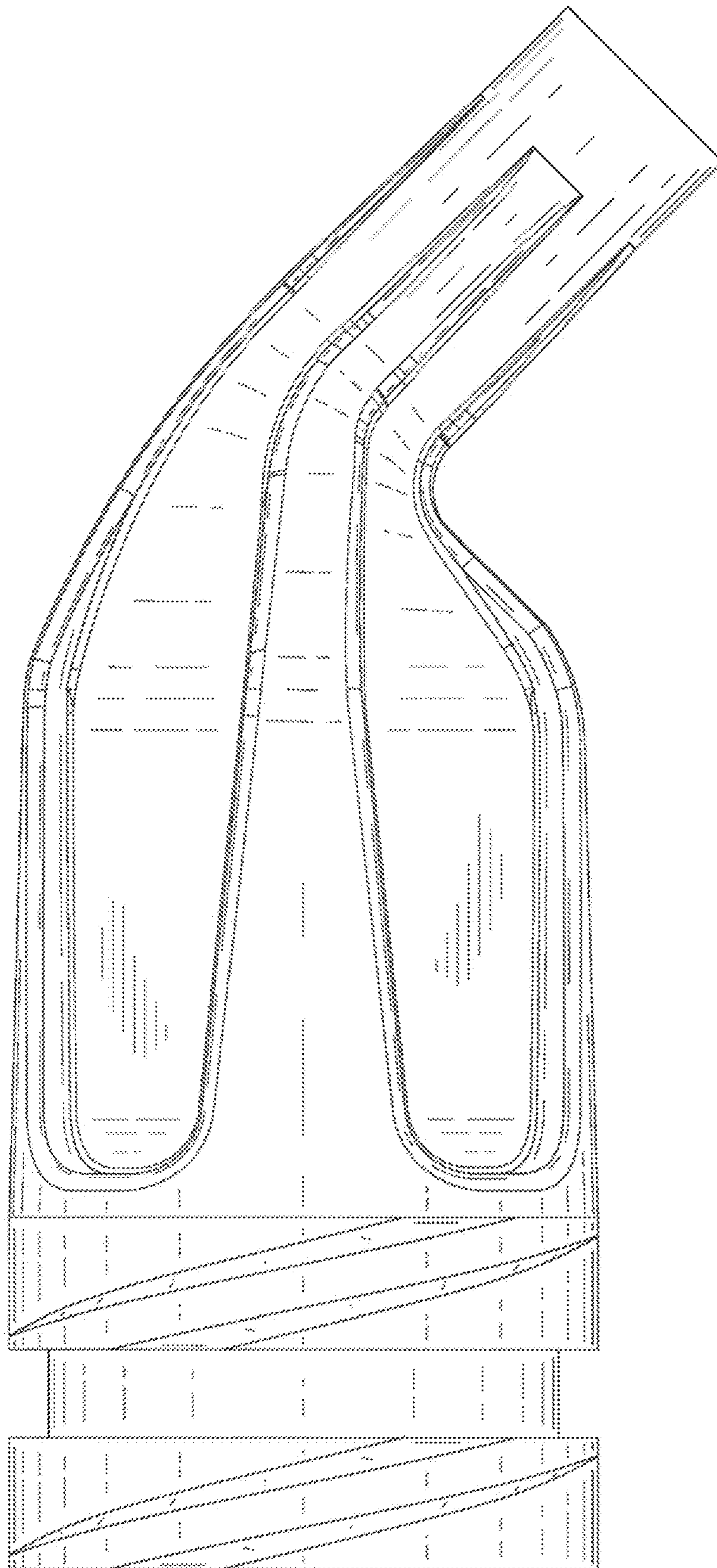

FIG. 3

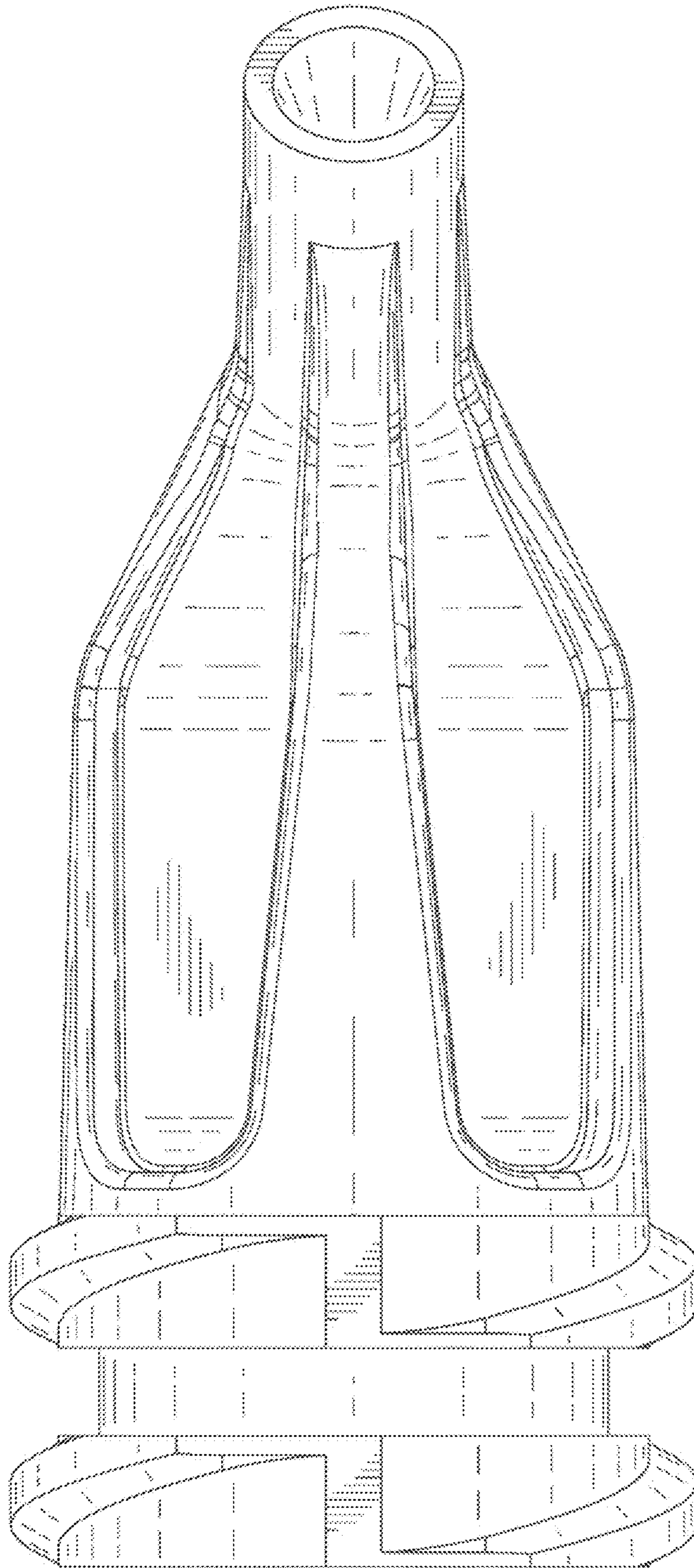

FIG. 4

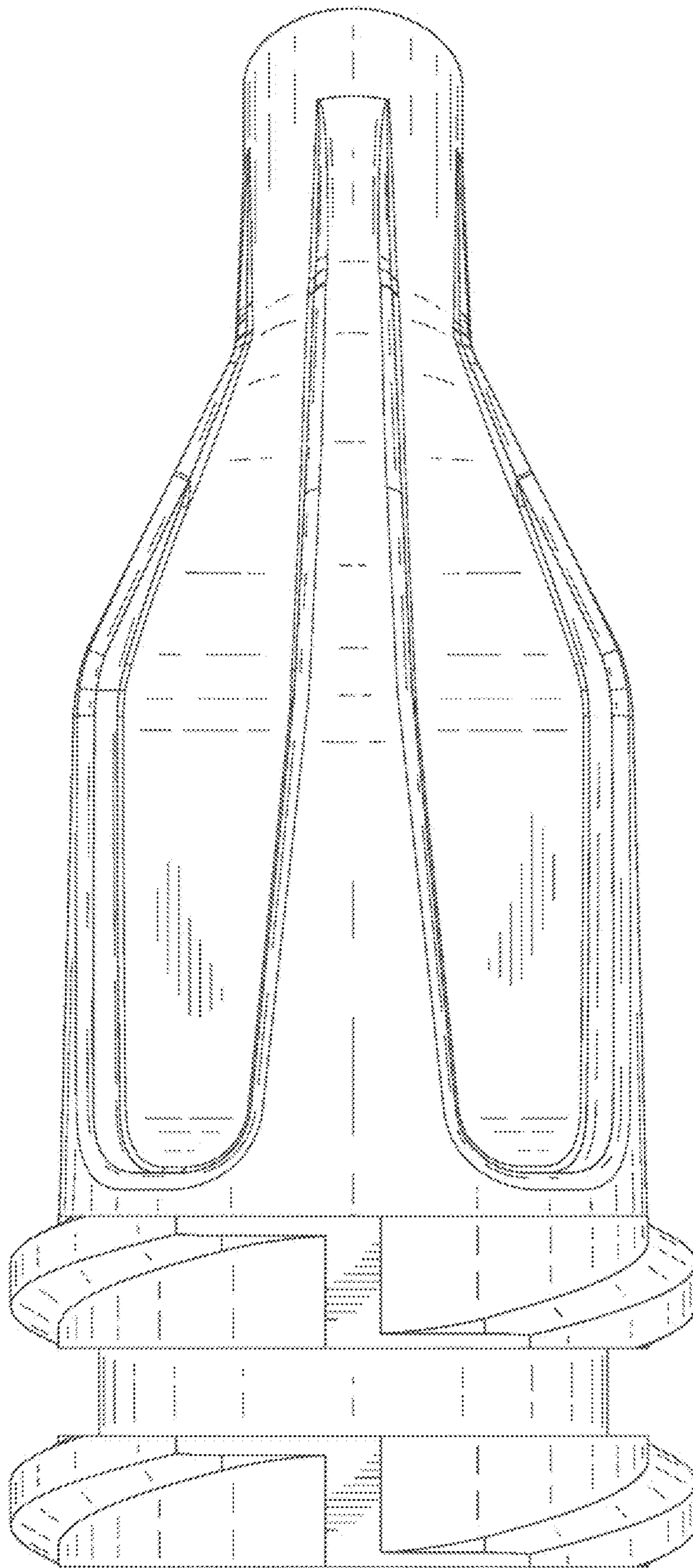

FIG. 5

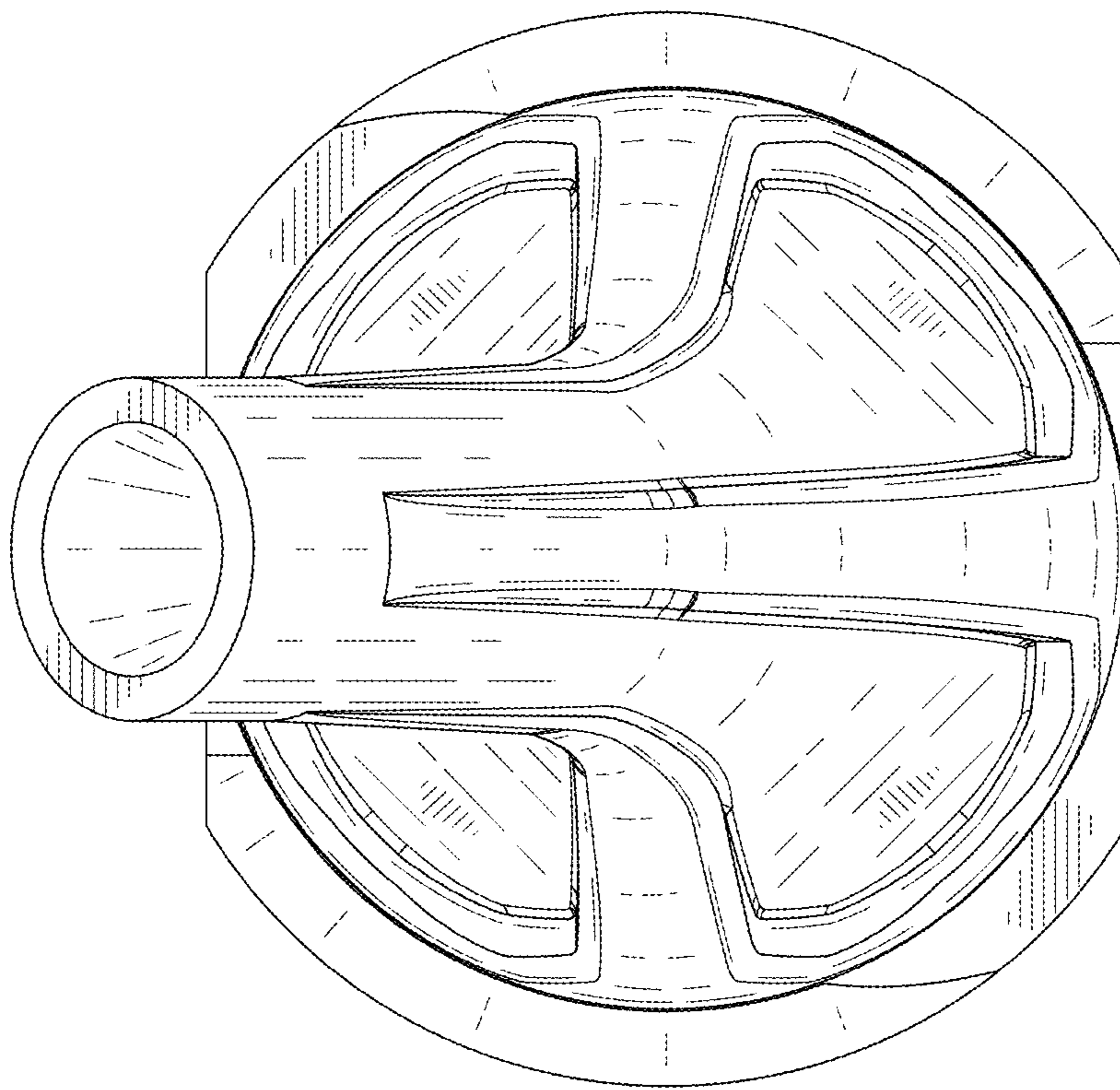

FIG. 6

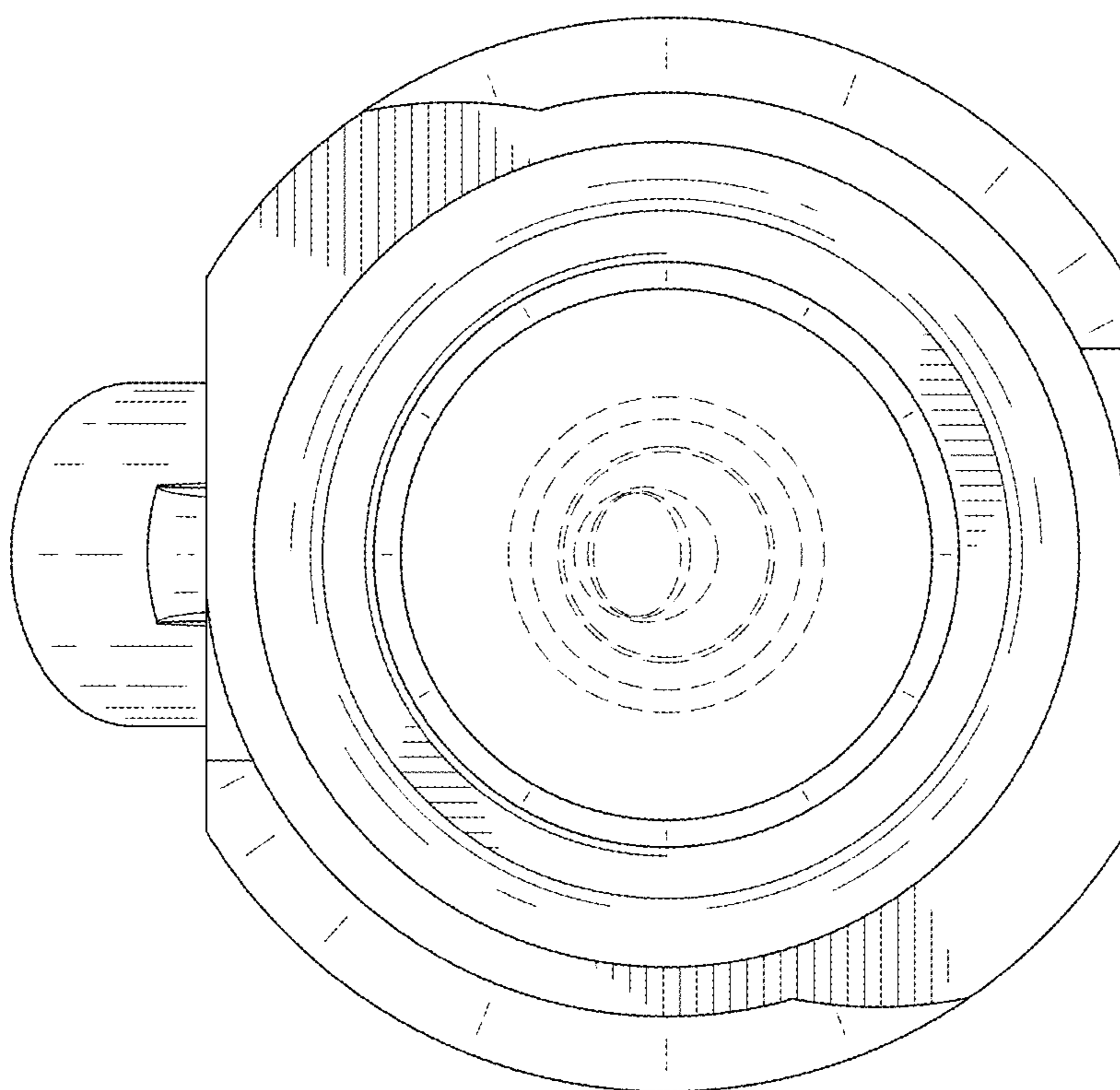

FIG. 7

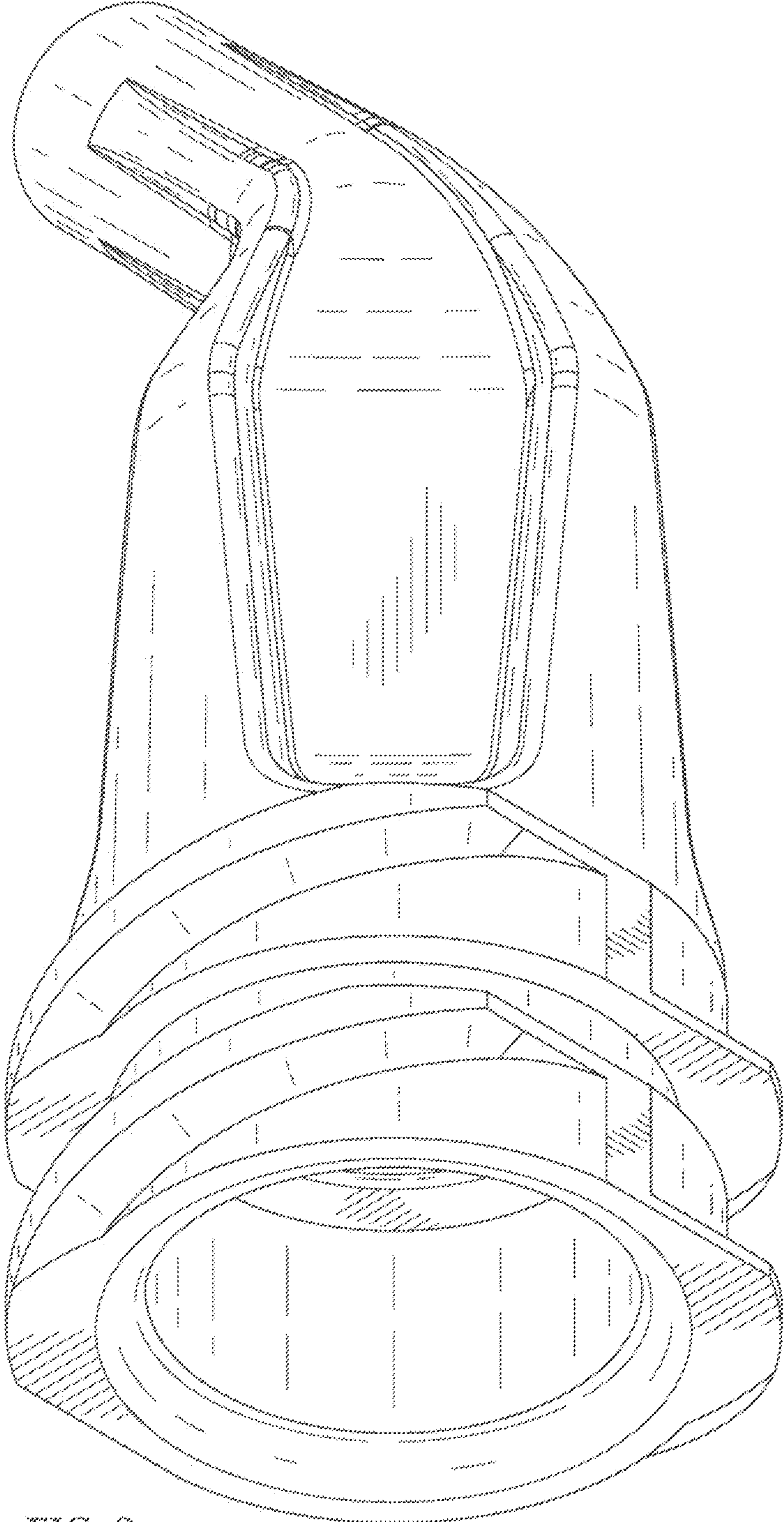

FIG. 8