



US00D948019S

(12) **United States Design Patent**
Kim

(10) **Patent No.:** **US D948,019 S**

(45) **Date of Patent:** **** Apr. 5, 2022**

(54) **AIR PURIFIER**

(71) Applicant: **Easyrental Co., Ltd.**, Seoul (KR)

(72) Inventor: **Jong Man Kim**, Seoul (KR)

(**) Term: **15 Years**

(21) Appl. No.: **35/510,572**

(22) Filed: **Apr. 16, 2020**

(80) **Hague Agreement Data**

Int. Filing Date: **Apr. 16, 2020**

Int. Reg. No.: **DM/210445**

Int. Reg. Date: **Apr. 16, 2020**

Int. Reg. Pub. Date: **Oct. 16, 2020**

(30) **Foreign Application Priority Data**

Oct. 16, 2019 (KR) 30-2019-0049290

(51) **LOC (13) Cl.** **23-04**

(52) **U.S. Cl.**
USPC **D23/364**

(58) **Field of Classification Search**

USPC D23/355, 356, 359, 364, 370, 386

CPC B01D 46/00; B01D 46/0002; A61L 9/00

See application file for complete search history.

(56) **References Cited**

U.S. PATENT DOCUMENTS

D410,282 S * 5/1999 Gutmann D23/364

D421,108 S * 2/2000 Esty D23/355

D704,321 S *	5/2014	Jardine	D23/365
D749,202 S *	2/2016	Satou	D23/364
D798,430 S *	9/2017	Nord	D23/364
D862,673 S *	10/2019	Tang	D23/364
D869,626 S *	12/2019	Reisenberger	D23/364
D905,840 S *	12/2020	Cao	D23/364
D925,024 S *	7/2021	Huang	D23/356
D933,747 S *	10/2021	Ledbetter	D21/332
D933,797 S *	10/2021	Liu	D23/364
D933,798 S *	10/2021	Wang	D23/364
2018/0172290 A1 *	6/2018	Zhou	F24F 13/20

* cited by examiner

Primary Examiner — Michael A. Pratt

(57) **CLAIM**

The ornamental design for an air purifier, as shown and described.

DESCRIPTION

- 1. Air purifier
- 1.1 : Perspective
- 1.2 : Front
- 1.3 : Back
- 1.4 : Left
- 1.5 : Right
- 1.6 : Top
- 1.7 : Bottom

An air purifier with 4-way discharging ports in upper part of the body is shown in the reproductions.

1 Claim, 7 Drawing Sheets

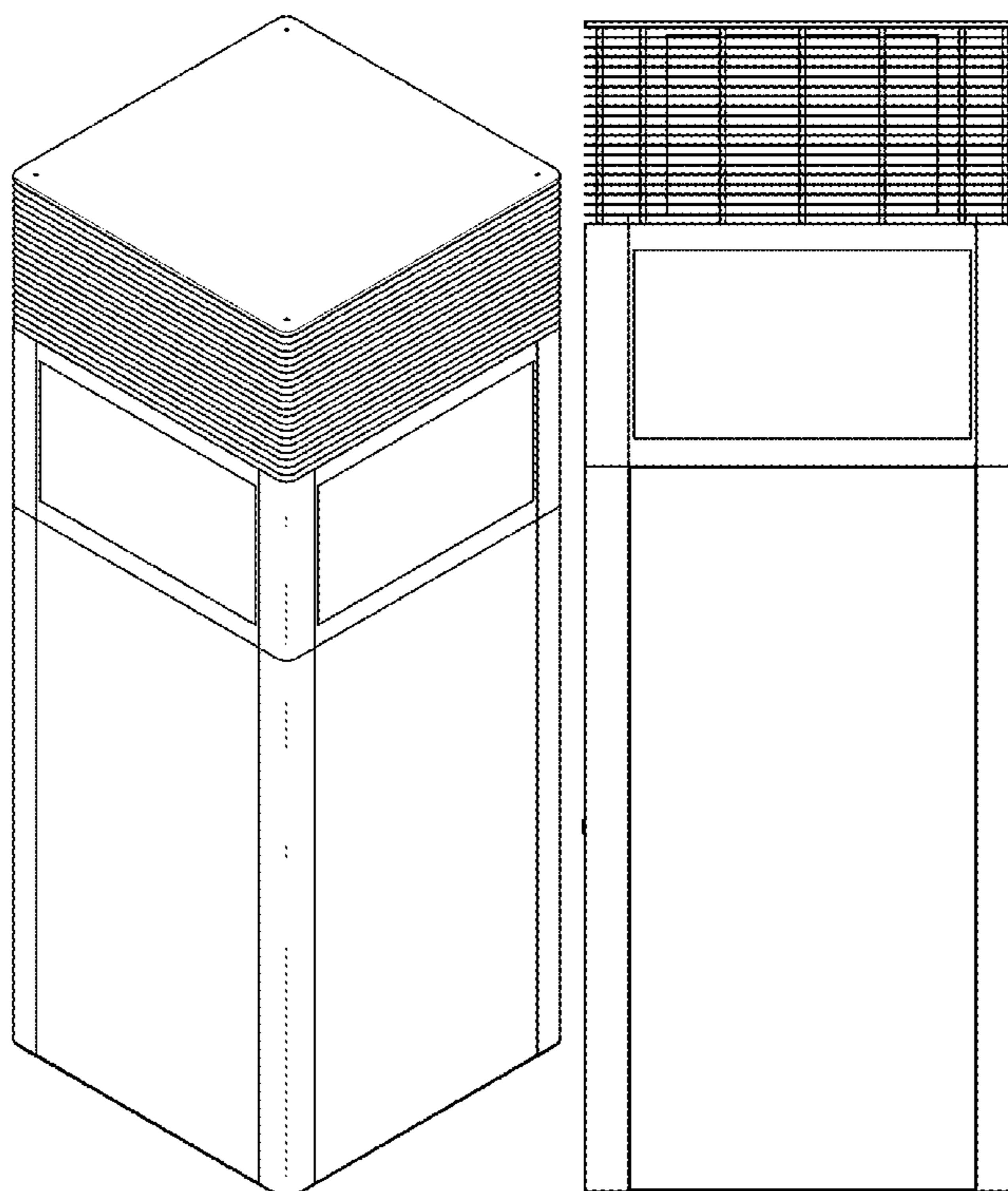

1.1

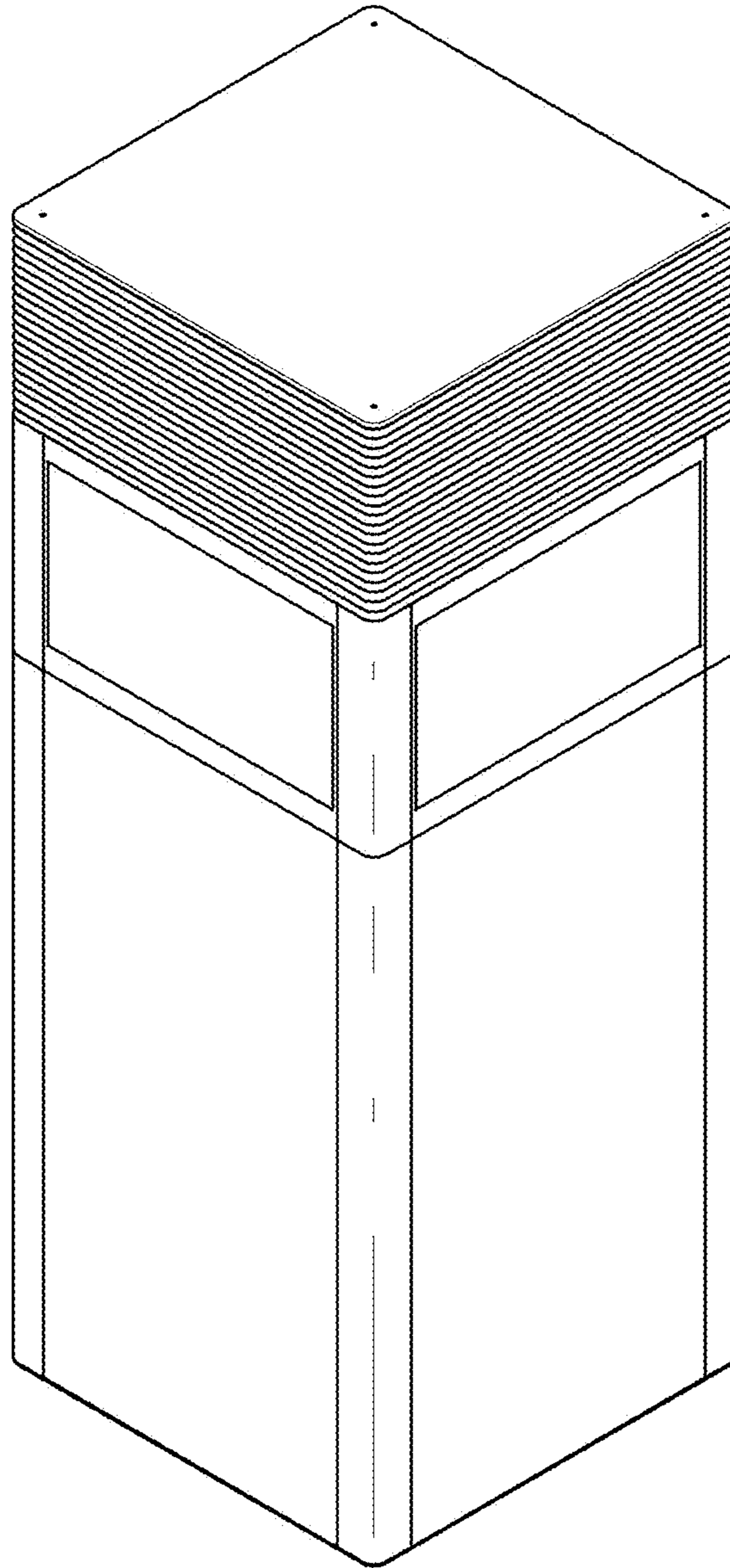

1.2

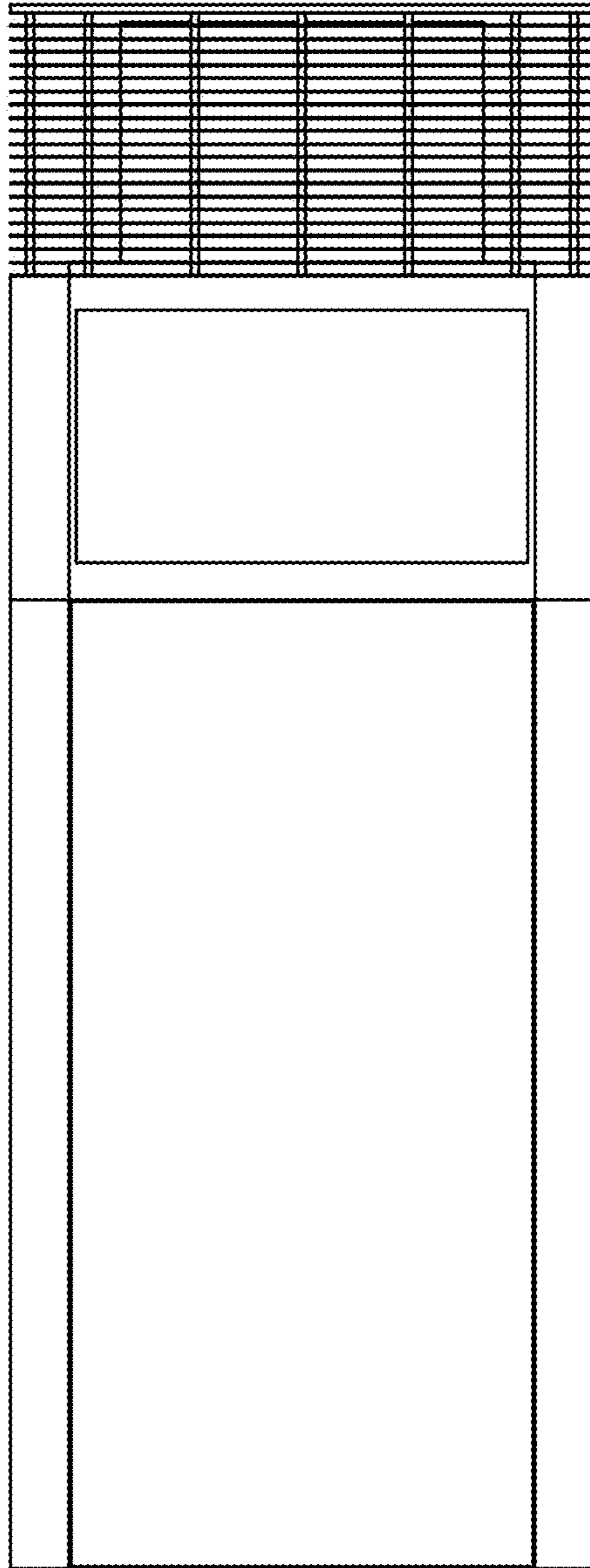

1.3

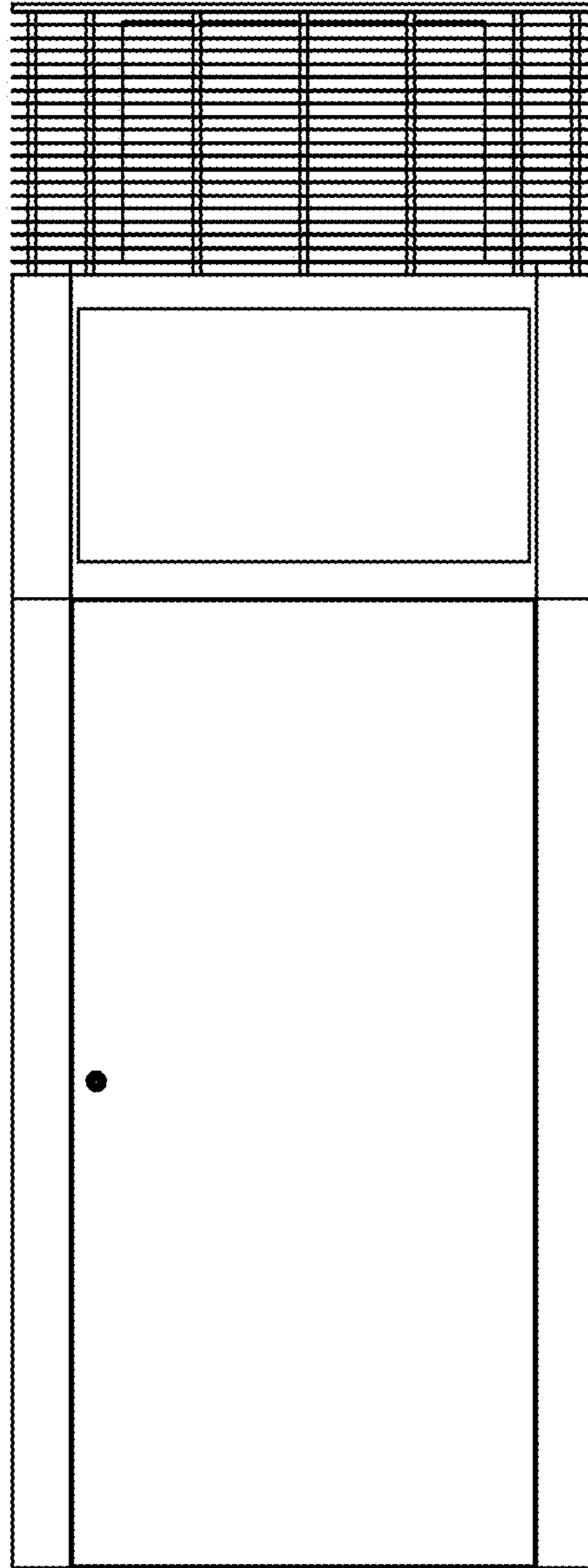

1.4

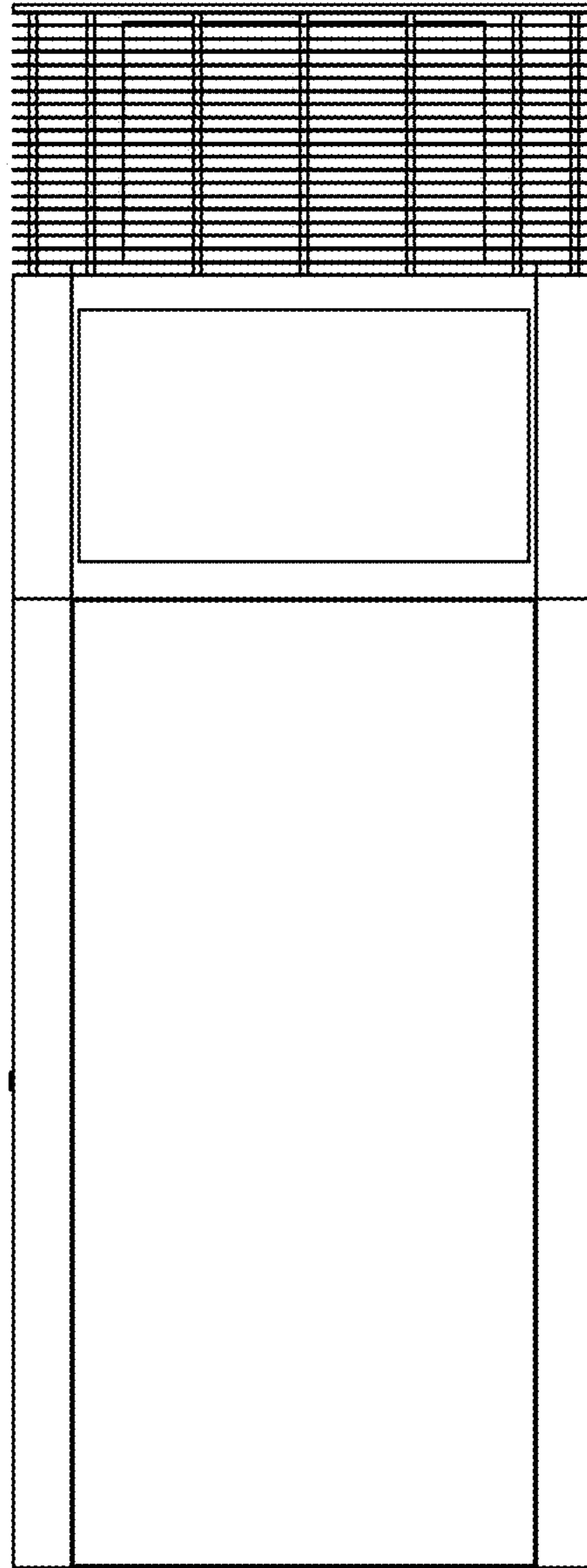

1.5

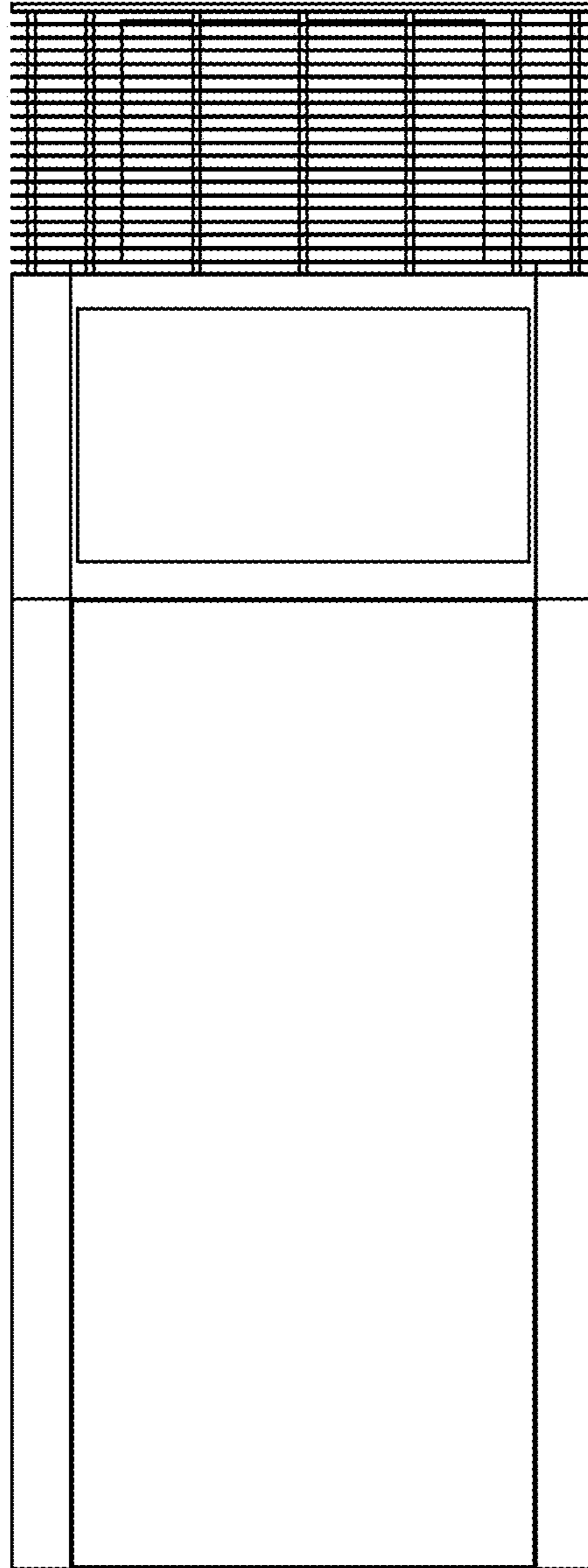

1.6

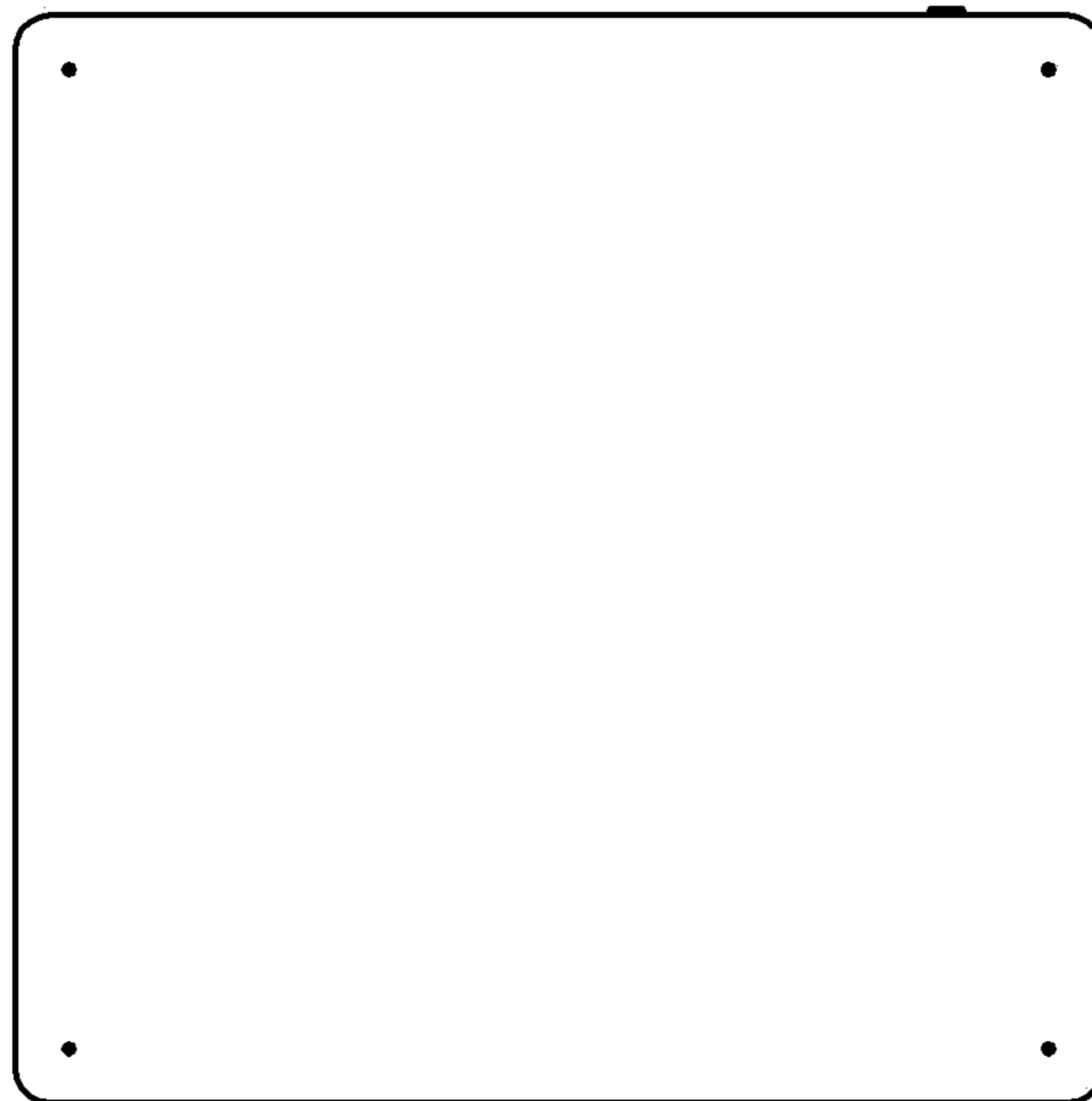

1.7

