

US00D947972S

(12) **United States Design Patent**  
**Goserud**

(10) **Patent No.:** **US D947,972 S**

(45) **Date of Patent:** **\*\* Apr. 5, 2022**

(54) **GOLF PUTTING DEVICE**

(71) Applicant: **J. Thomas Goserud**, Landisville, PA  
(US)

(72) Inventor: **J. Thomas Goserud**, Landisville, PA  
(US)

(\*\*) Term: **15 Years**

(21) Appl. No.: **29/652,462**

(22) Filed: **Aug. 21, 2020**

(51) **LOC (13) Cl.** ..... **21-02**

(52) **U.S. Cl.**  
USPC ..... **D21/791**

(58) **Field of Classification Search**  
USPC ..... D21/789, 791  
CPC ..... A63B 69/3676; A63B 69/3697; A63B  
69/3608; A63B 69/3661; A63B 69/3667;  
A63B 63/00; A63B 63/007; A63B  
57/357; A63B 57/40

See application file for complete search history.

(56) **References Cited**

**U.S. PATENT DOCUMENTS**

1,076,722	A *	10/1913	Treadwell	.....	A63B 57/357 473/187
1,229,766	A *	6/1917	Long	.....	A63B 57/40 473/187
1,287,903	A *	12/1918	Daily	.....	A63B 57/357 473/180
D174,253	S *	3/1955	Evans	.....	D21/790
2,933,318	A *	4/1960	Boynton	.....	A63B 63/00 473/186
3,114,556	A *	12/1963	Miller	.....	A63B 57/357 473/185
3,752,482	A *	8/1973	Cassel	.....	A63B 57/357 473/169
3,938,805	A *	2/1976	Sakuma	.....	A63B 53/14 473/406
D242,370	S *	11/1976	Arndt	.....	D21/790

D257,785	S *	1/1981	Arndt	.....	D21/790
4,878,671	A *	11/1989	Gubany	.....	A63B 67/02 473/195
4,906,006	A *	3/1990	Sigunick	.....	A63B 57/357 473/185
5,257,808	A *	11/1993	Mueller	.....	A63B 69/3623 473/174
D346,831	S *	5/1994	Adams	.....	D21/790
5,487,545	A *	1/1996	Schindler	.....	A63B 69/3676 473/187
D372,062	S *	7/1996	Spiegel	.....	D21/716

(Continued)

*Primary Examiner* — Mitchell I. Siegel

(74) *Attorney, Agent, or Firm* — Dunlap Bennett &  
Ludwig, PLLC; Brendan E. Squire

(57) **CLAIM**

The ornamental design for a golf putting device, as shown and described.

**DESCRIPTION**

FIG. 1 is a rear perspective view of a golf putting device, showing my new design in use;  
 FIG. 2 is a front elevation view thereof;  
 FIG. 3 is a rear elevation view thereof;  
 FIG. 4 is a top plan view thereof;  
 FIG. 5 is a left side elevation view thereof;  
 FIG. 6 is a bottom plan view thereof;  
 FIG. 7 is a sectional view thereof taken along line 7-7 of FIG. 4;  
 FIG. 8 is a front perspective view thereof; and,  
 FIG. 9 is an exploded front perspective view thereof shown in use.

The broken lines shown in the drawings of FIGS. 6 and 7 illustrate a boundary that forms no part of the claimed design.

The broken lines in FIGS. 1 and 9 showing the golf putting device in use illustrate environment and forms no part of the claim.

**1 Claim, 6 Drawing Sheets**

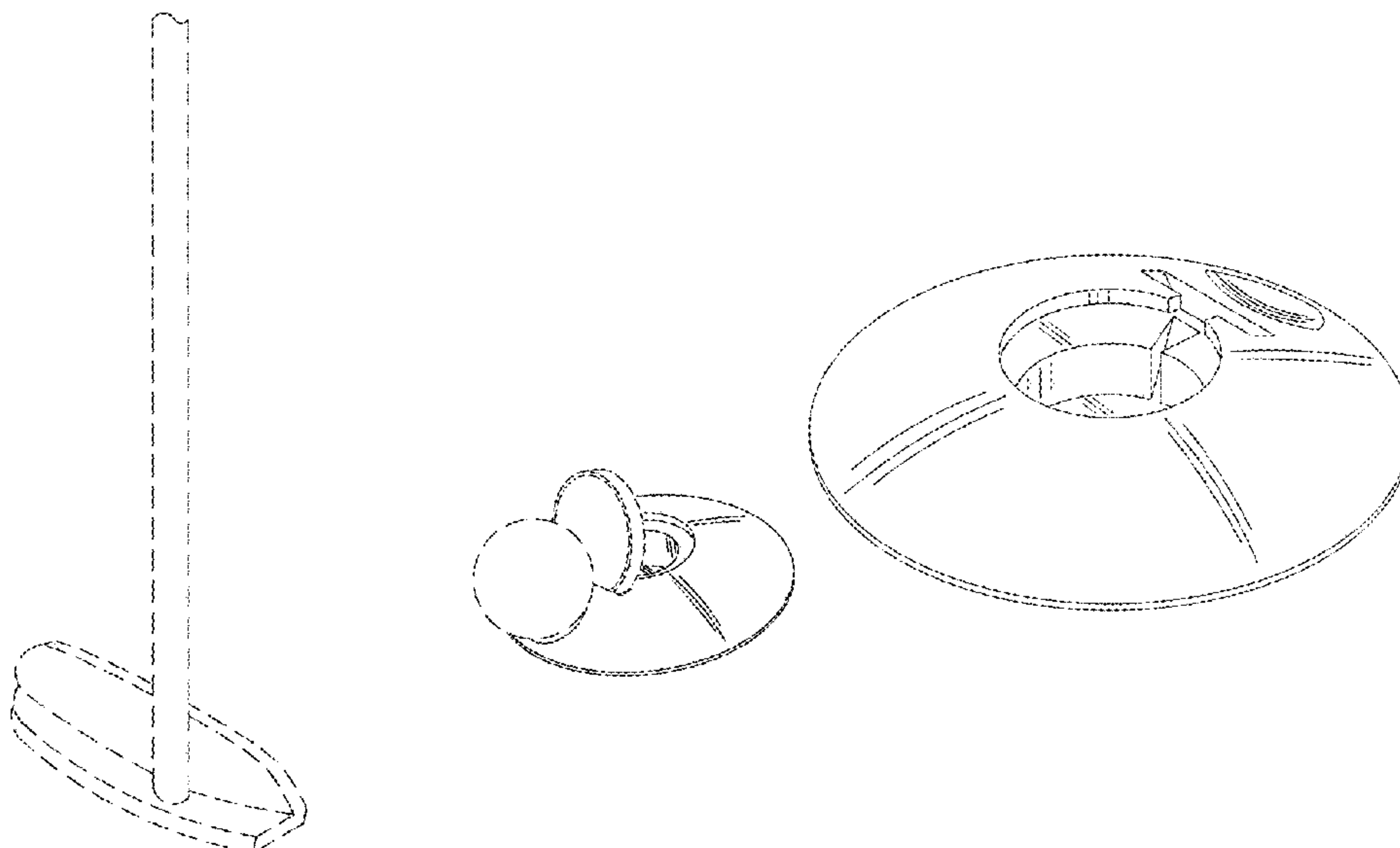

(56)

**References Cited**

U.S. PATENT DOCUMENTS

D411,601 S \* 6/1999 Fong ..... D21/791  
5,997,406 A \* 12/1999 Selton ..... A63B 63/007  
473/180  
D540,902 S \* 4/2007 Regalado ..... D21/794  
7,914,387 B1 \* 3/2011 Gugliotti ..... A63B 67/02  
473/174  
D741,972 S \* 10/2015 McDevitt ..... D21/794  
9,327,176 B1 \* 5/2016 Goserud ..... A63B 69/3676  
D780,870 S \* 3/2017 Hamilton ..... A63B 57/40  
D21/791  
D795,376 S \* 8/2017 Keisler ..... D21/791  
D816,178 S \* 4/2018 Goserud ..... D21/794  
D862,622 S \* 10/2019 Goserud ..... D21/791  
D870,222 S \* 12/2019 Mcilvain ..... D21/791  
D916,222 S \* 4/2021 Goserud ..... D21/791  
D920,457 S \* 5/2021 Santo ..... D21/791

\* cited by examiner

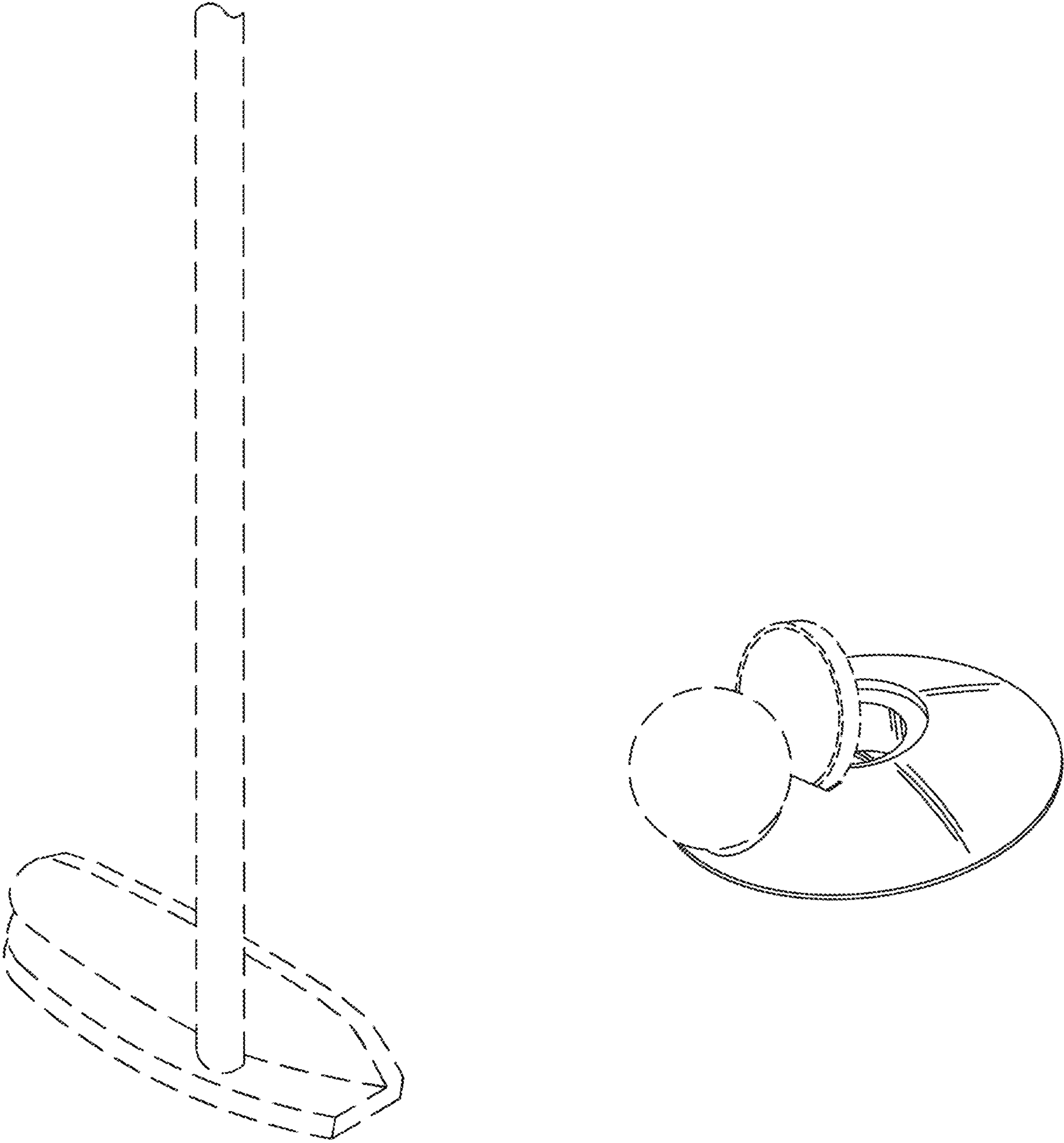

FIG. 1

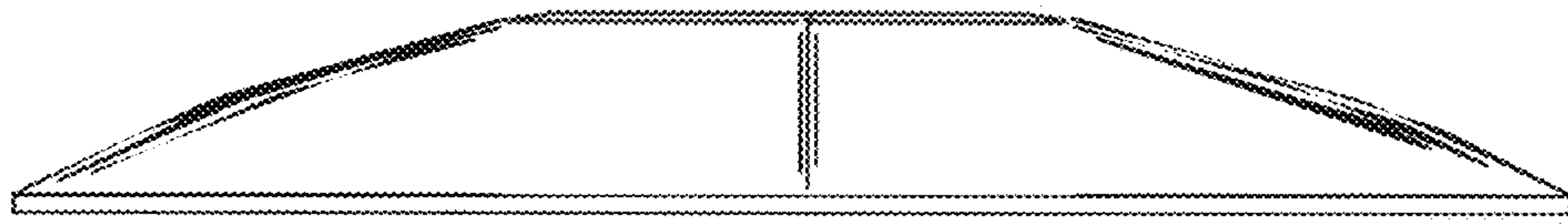

FIG. 2



FIG. 3

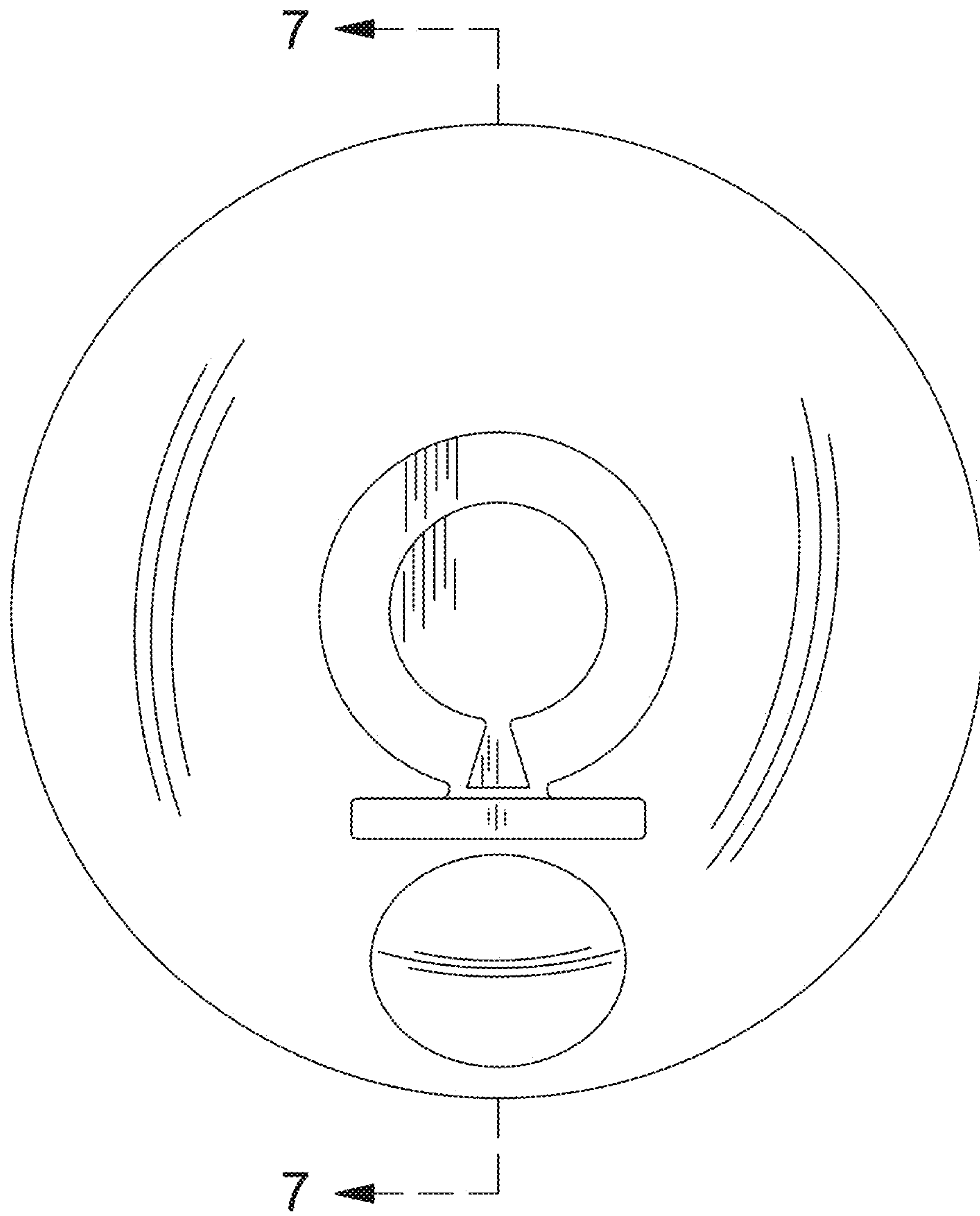

FIG. 4

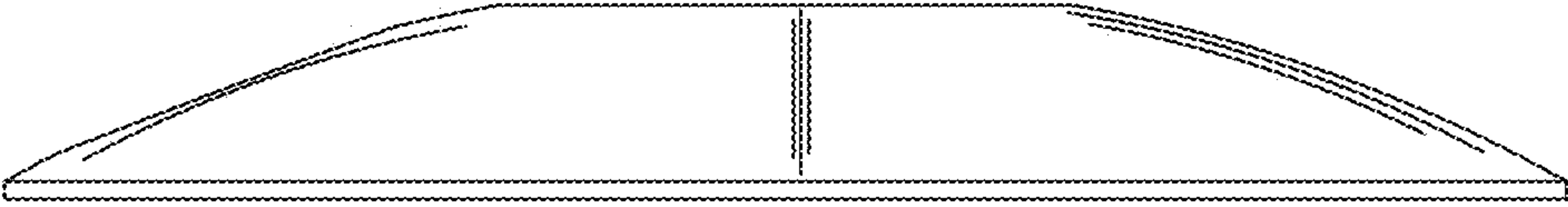

FIG. 5

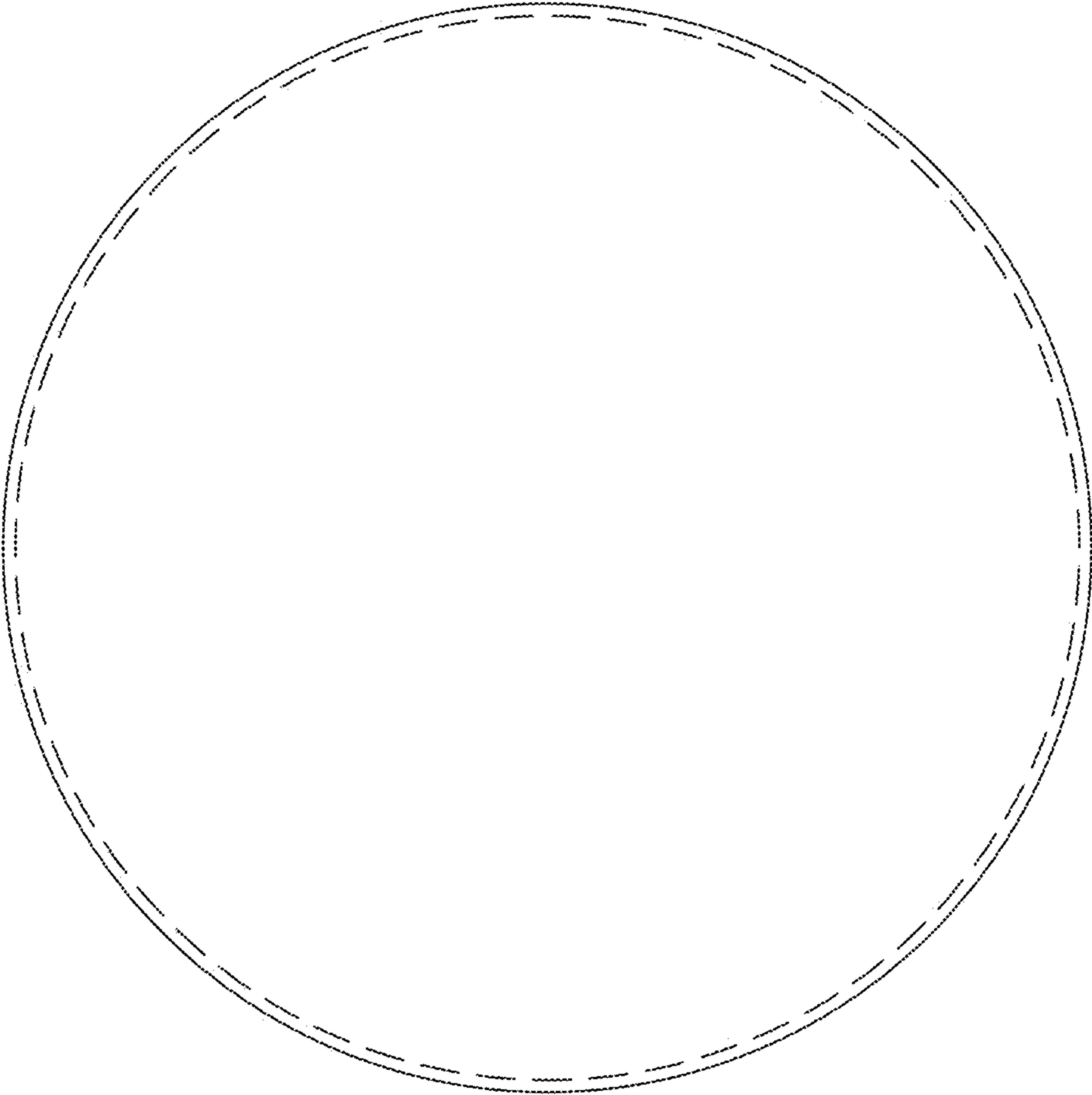

FIG. 6



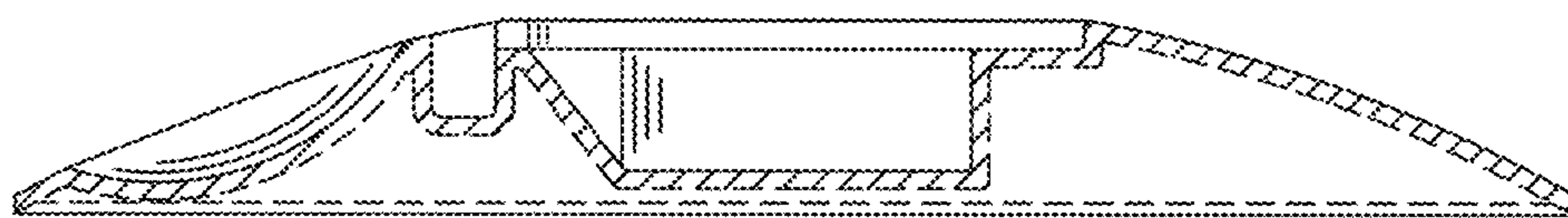

FIG. 7

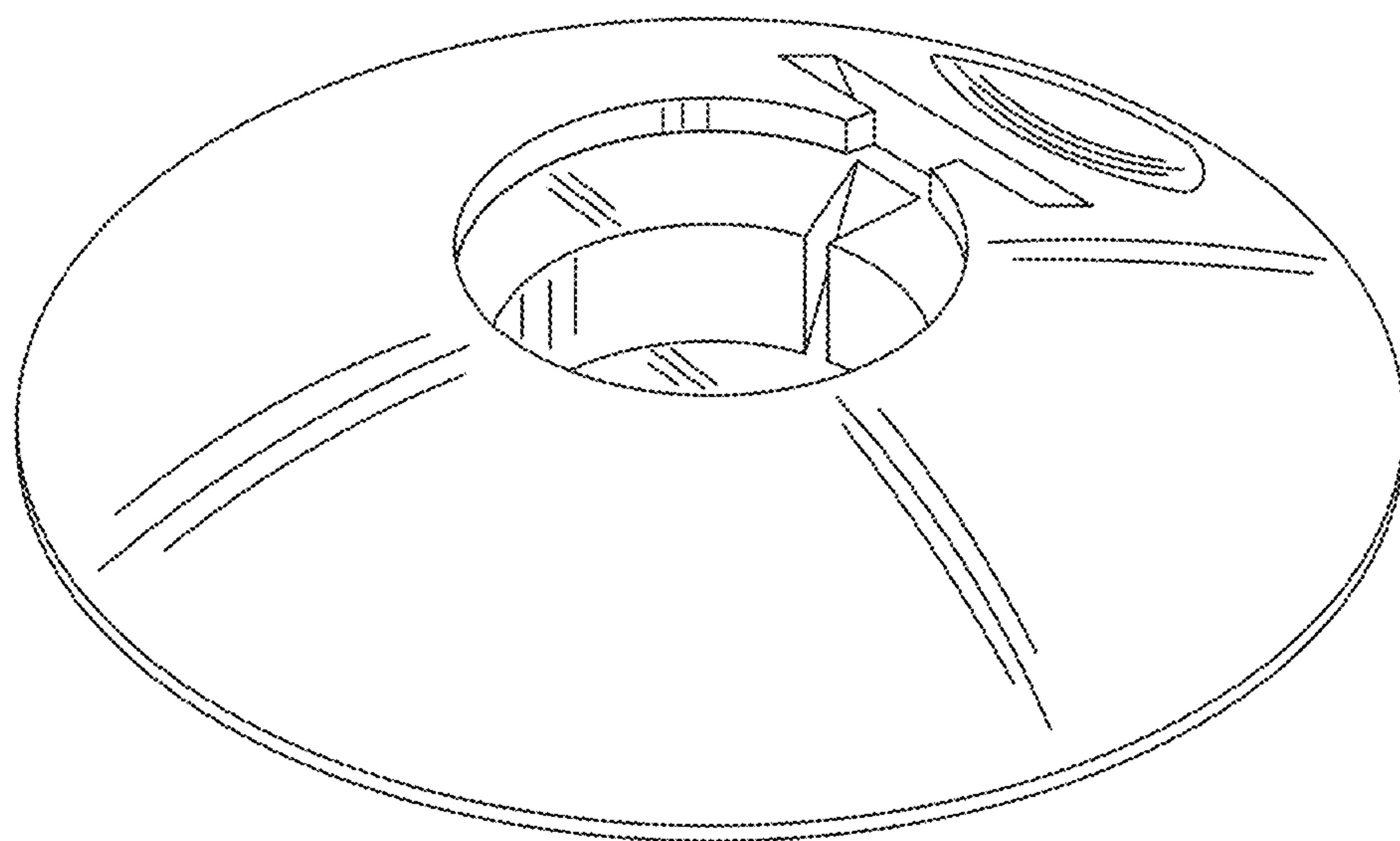

FIG. 8

FIG. 9

