



US00D947836S

(12) **United States Design Patent**
Li et al.

(10) **Patent No.:** **US D947,836 S**

(45) **Date of Patent:** **** Apr. 5, 2022**

(54) **SMART HOME DEVICE**

(71) Applicant: **Consumer 2.0 Inc.**, Los Angeles, CA (US)

(72) Inventors: **Zhe Clark Li**, Thousand Oaks, CA (US); **Chunmeng Han**, Thousand Oaks, CA (US)

(73) Assignee: **CONSUMER 2.0 INC.**, Los Angeles, CA (US)

(**) Term: **15 Years**

(21) Appl. No.: **29/667,817**

(22) Filed: **Oct. 25, 2018**

(51) **LOC (13) Cl.** **14-02**

(52) **U.S. Cl.**
USPC **D14/341**

(58) **Field of Classification Search**
USPC D14/138 AA, 138 AB, 138 AC, 138 AD, D14/138 C, 138 G, 218, 248, 315–318,
(Continued)

(56) **References Cited**

U.S. PATENT DOCUMENTS

D694,751 S * 12/2013 Ju D14/341
D716,297 S * 10/2014 ZhenHua D14/371
(Continued)

FOREIGN PATENT DOCUMENTS

CN 305715802 * 4/2020
CN 305920750 * 7/2020
(Continued)

OTHER PUBLICATIONS

Amazon Echo Show 10 Review: Alexa’s Next Move, Feb. 24, 2021, [retrieved Aug. 11, 2021], Retrieved from Internet, URL: <<https://www.theverge.com/22297810/amazon-echo-show-10-2021-review>> (Year: 2021).*

(Continued)

Primary Examiner — Barbara Fox

Assistant Examiner — Aram Kwon

(74) *Attorney, Agent, or Firm* — Eagle IP Limited; Jacqueline C. Lui

(57) **CLAIM**

The ornamental design for a smart home device, as shown and described.

DESCRIPTION

FIG. 1 is a front view of a smart home device showing our new design;

FIG. 2 is a rear view thereof;

FIG. 3 is a right side view thereof;

FIG. 4 is a left side view thereof;

FIG. 5 is a top view thereof;

FIG. 6 is a bottom view thereof;

FIG. 7 is a front perspective view thereof;

FIG. 8 is a rear perspective view thereof;

FIG. 9 is another rear perspective view thereof;

FIG. 10 is an exploded rear view thereof;

FIG. 11 is a front view thereof;

FIG. 12 is a rear view of the smart home device, shown with the back bracket removed from the main body to show aspects of the design that are not visible when combined;

FIG. 13 is a right side view thereof;

FIG. 14 is a left side view thereof;

FIG. 15 is a top view thereof;

FIG. 16 is a bottom view thereof;

FIG. 17 is a front perspective view thereof;

FIG. 18 is a front view of the back bracket of the smart home device, shown separately from the main body to show aspects of the design that are not visible when combined;

FIG. 19 is a rear view thereof;

FIG. 20 is a right side view thereof;

FIG. 21 is a left side view thereof;

FIG. 22 is a top view thereof;

FIG. 23 is a bottom view thereof; and,

FIG. 24 is a rear perspective view thereof.

(Continued)

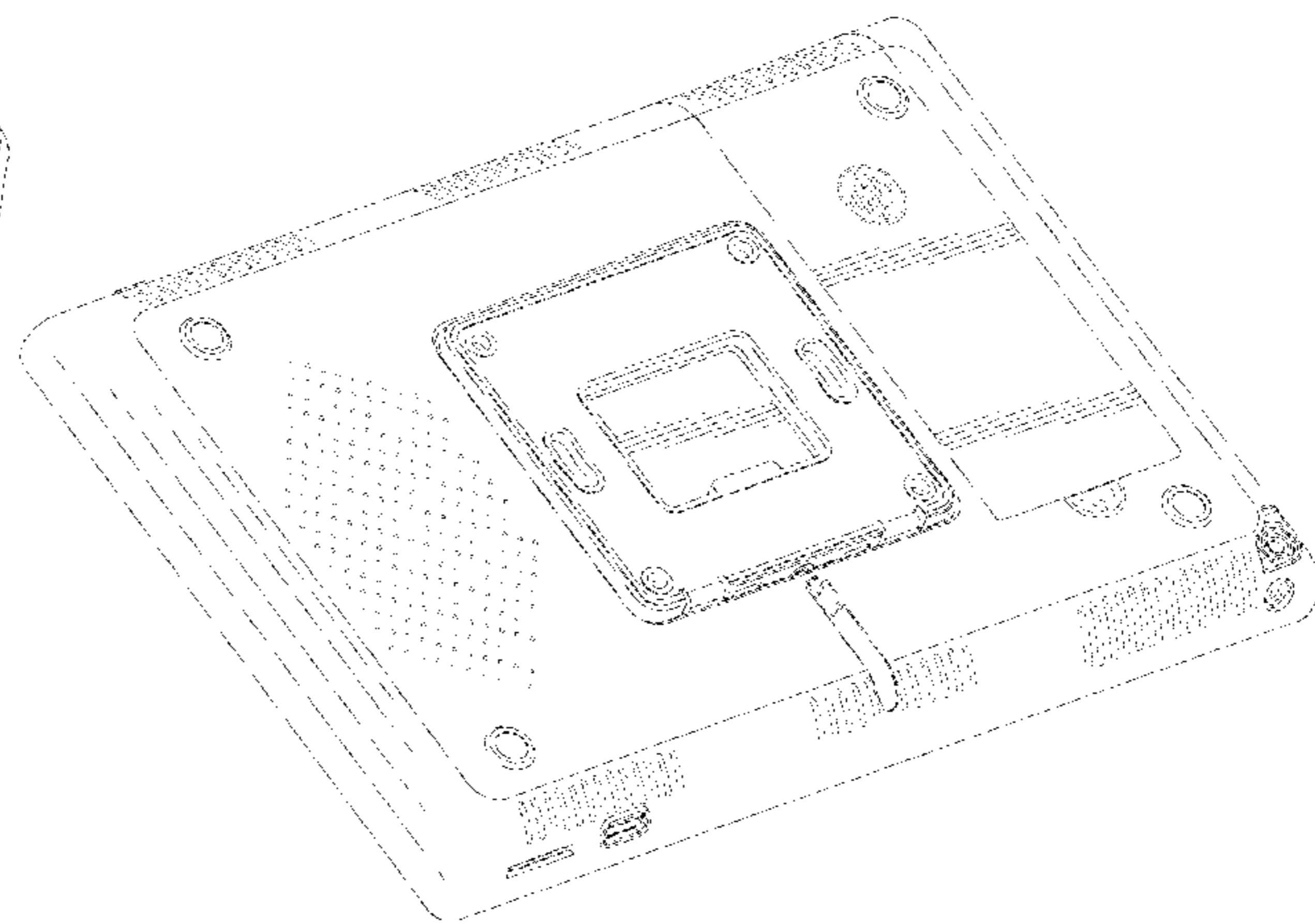
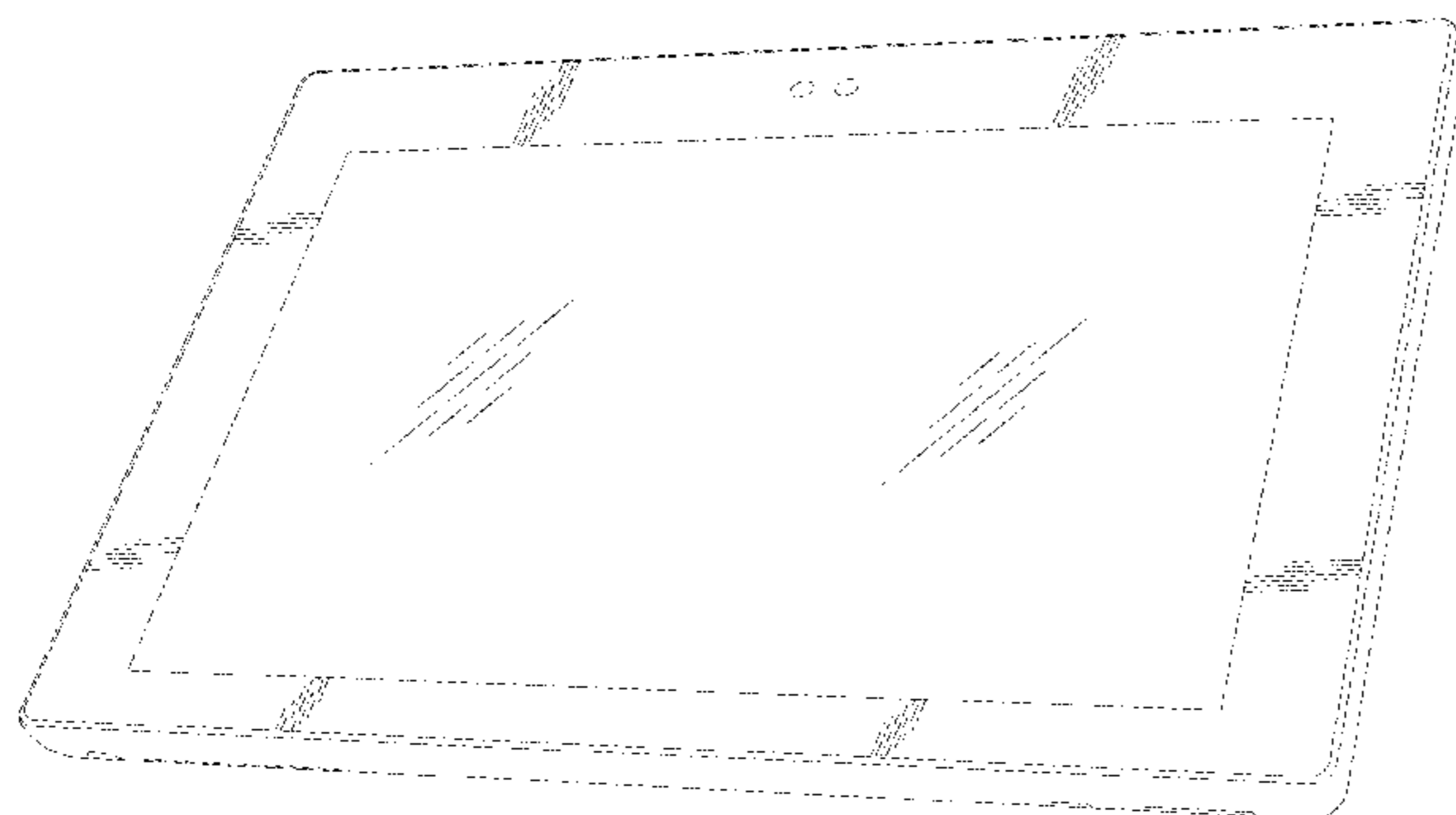

The broken lines shown in the drawings depict portions of the smart home device that form no part of the claimed design.

1 Claim, 24 Drawing Sheets

(58) Field of Classification Search

USPC D14/341–347, 371, 374; D6/308, 310;
 D10/30, 50, 65, 104.1; D18/6–7;
 D19/26, 59–60; D21/324, 329–330, 332
 CPC ... H04M 1/0202; H04M 1/0266; H04M 1/725
 See application file for complete search history.

(56) References Cited

U.S. PATENT DOCUMENTS

D751,063	S	*	3/2016	Lin	D14/341
D778,279	S	*	2/2017	Pendse	D14/341
D813,227	S	*	3/2018	Lin	D14/341
D869,418	S	*	12/2019	Lim	D14/126
D874,950	S	*	2/2020	Gentle	D10/50
D891,124	S	*	7/2020	Zhou	D6/310
D900,807	S	*	11/2020	Nishizawa	D14/341

D917,465	S	*	4/2021	Zhang	D14/342
D920,325	S	*	5/2021	Andresen	D14/336
D928,776	S	*	8/2021	Seok	D14/341

FOREIGN PATENT DOCUMENTS

EM	006867115-0001	*	9/2019
EM	008568125-0001	*	6/2021

OTHER PUBLICATIONS

Facebook Portal, date first available: Sep. 17, 2019, [retrieved Aug. 11, 2021], Retrieved from Internet, URL: <<https://www.amazon.com/Facebook-Portal-Calling-Screen-Display/dp/B07XPDYRRJ>> (Year: 2019).*

Google Home Hub Review: A friendlier smart display, Oct. 22, 2018, [retrieved Aug. 11, 2021], Retrieved from Internet, URL: <<https://www.slashgear.com/google-home-hub-review-a-friendlier-smart-display-22550833/>> (Year: 2018).*

Lenovo's Smart Display . . . , Jul. 26, 2018, [retrieved Aug. 11, 2021], Retrieved from Internet, URL: <<https://mashable.com/review/lenovo-smart-display-review>> (Year: 2018).*

Atmos Smart Home . . . , Feb. 1, 2018, [retrieved Aug. 11, 2021], Retrieved from Internet, URL: <<https://www.digitaltrends.com/home/atmos-smart-home-control-system/>> (Year: 2018).*

* cited by examiner

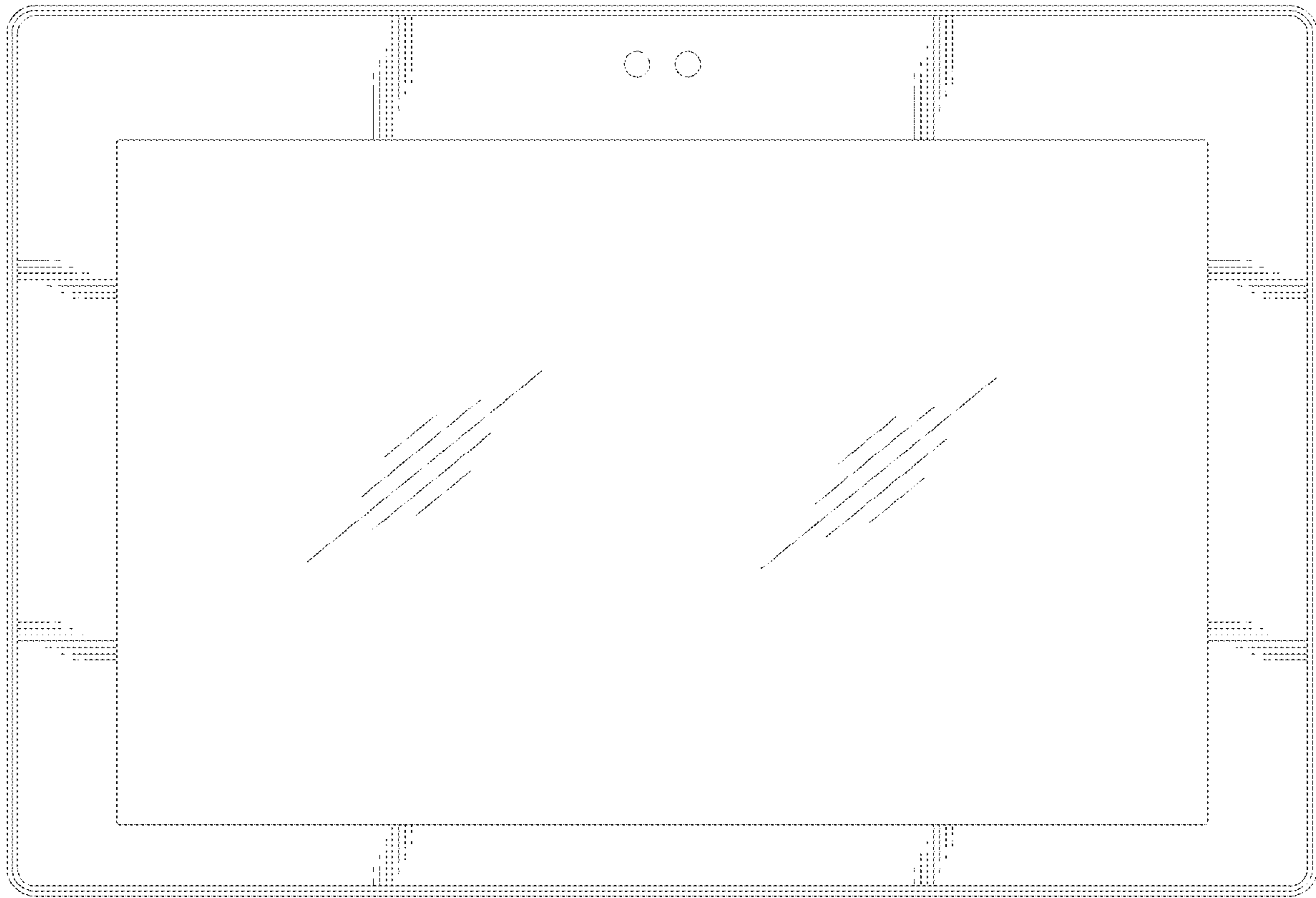

FIG. 1

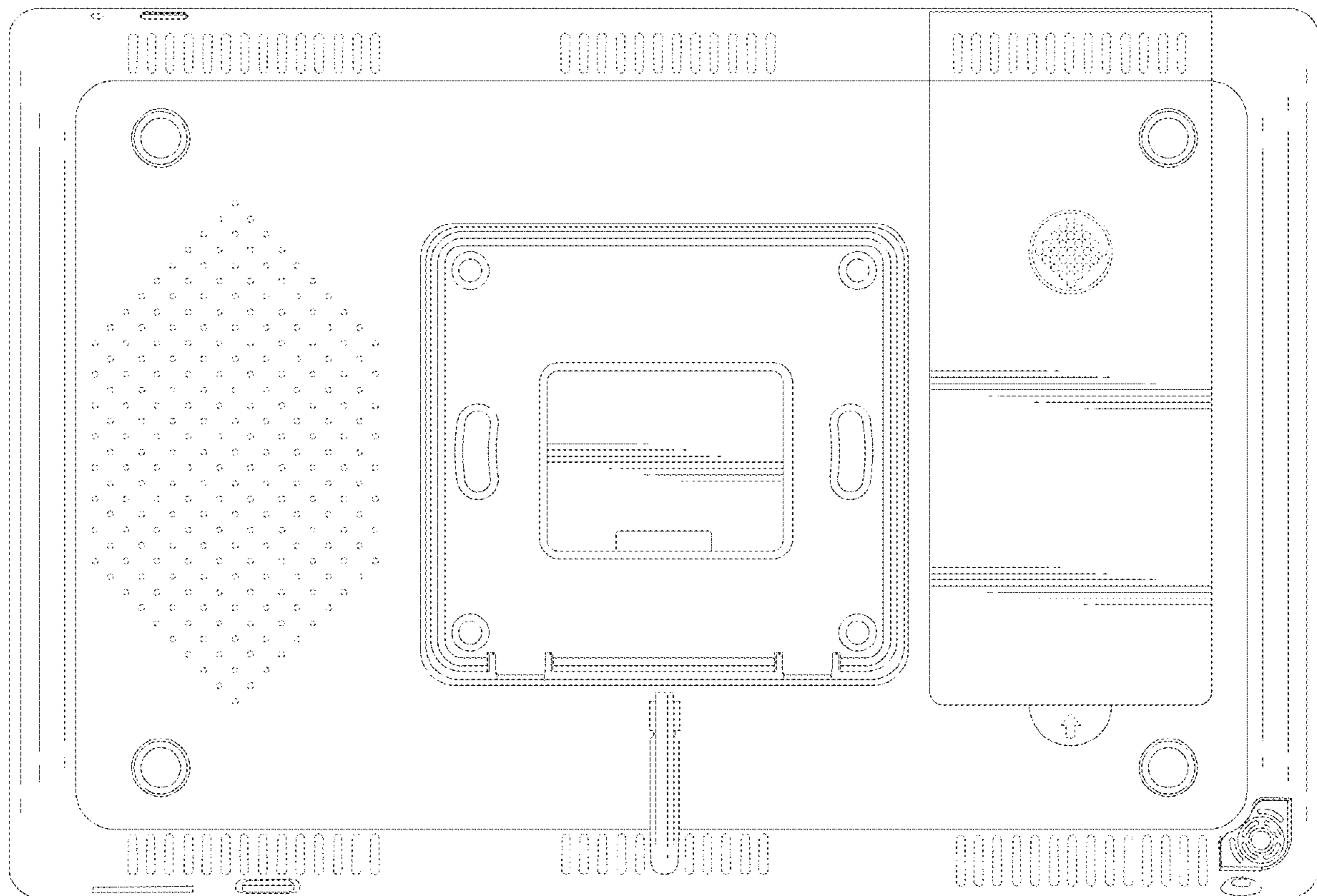

FIG. 2

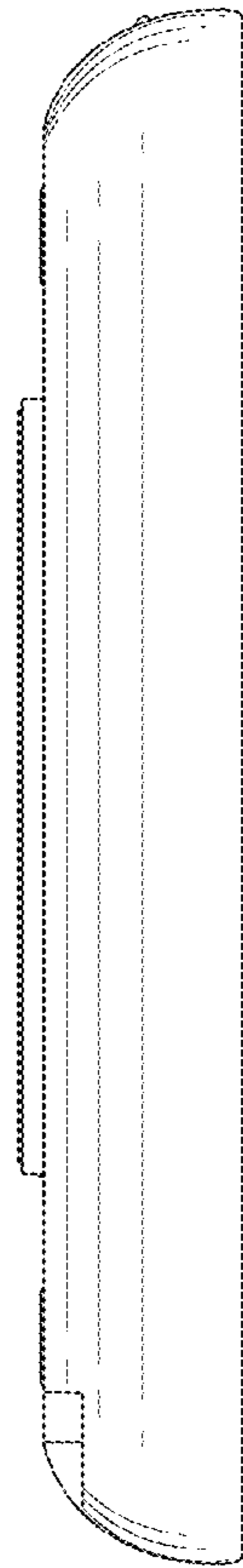

FIG. 3

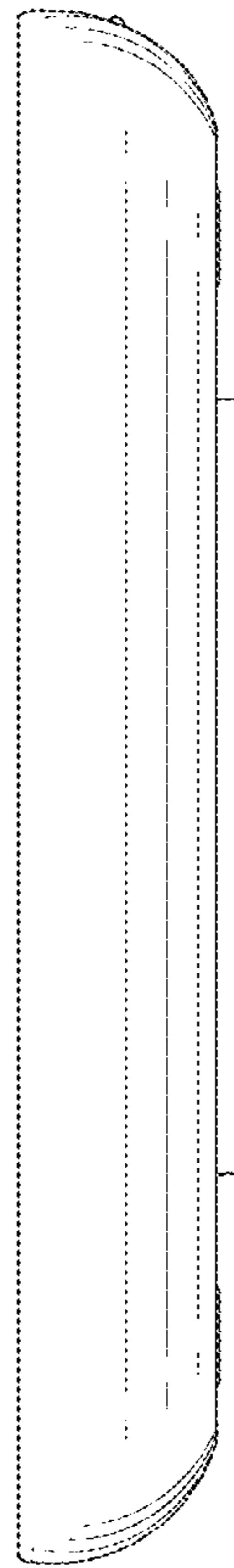

FIG. 4

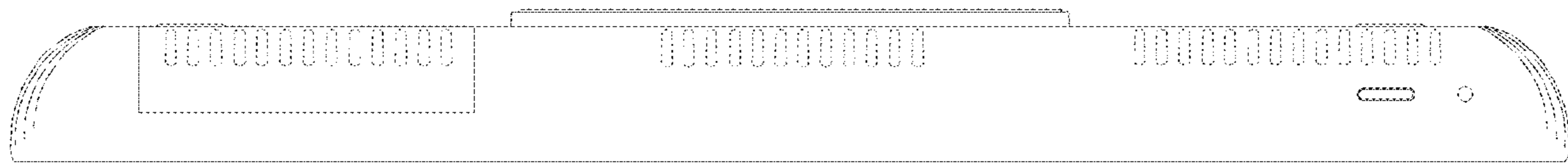

FIG. 5

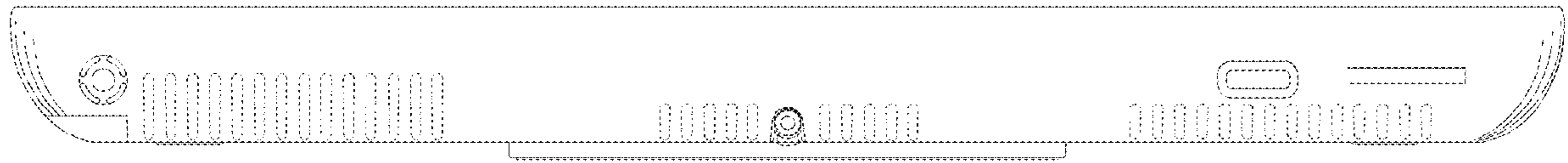

FIG. 6

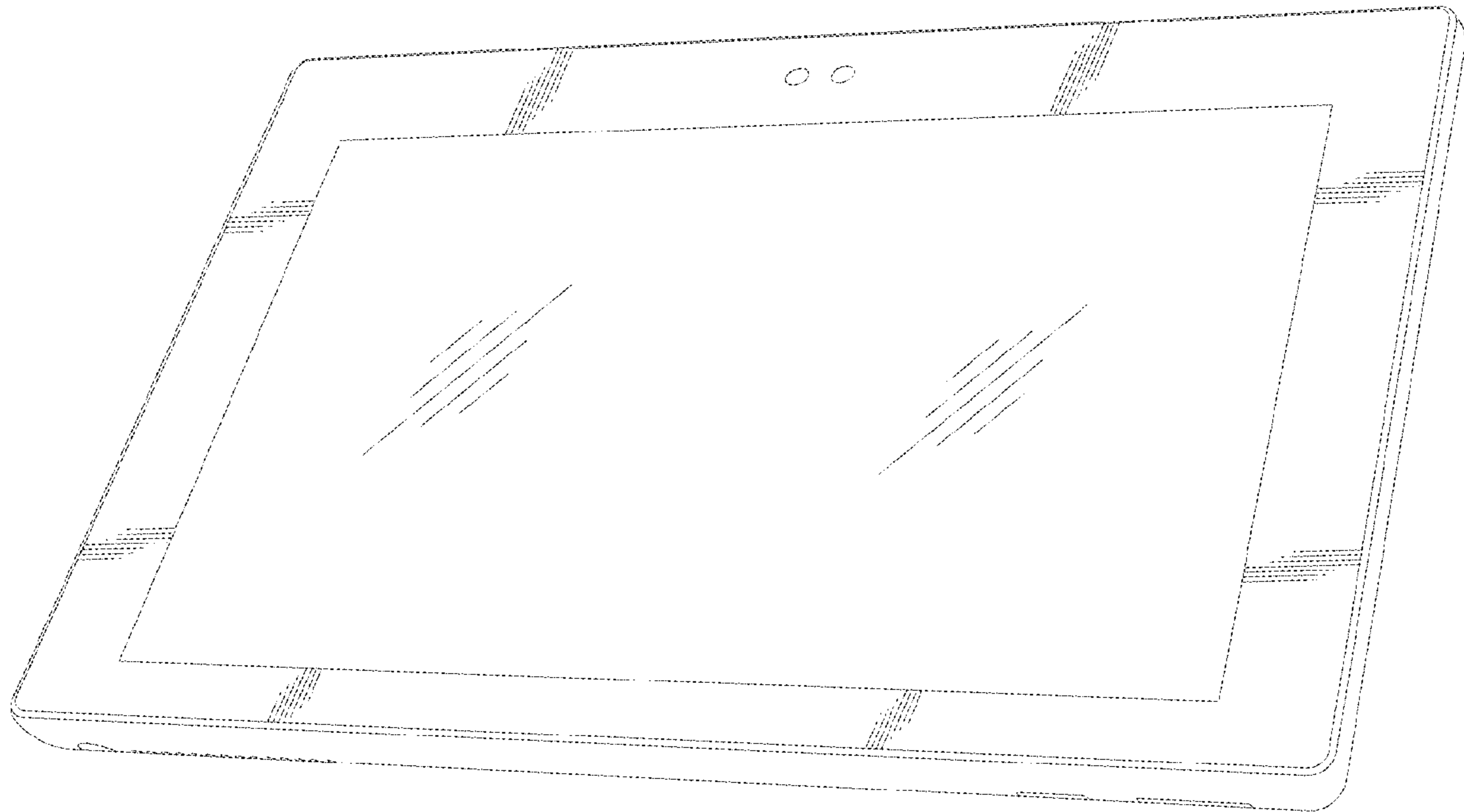

FIG. 7

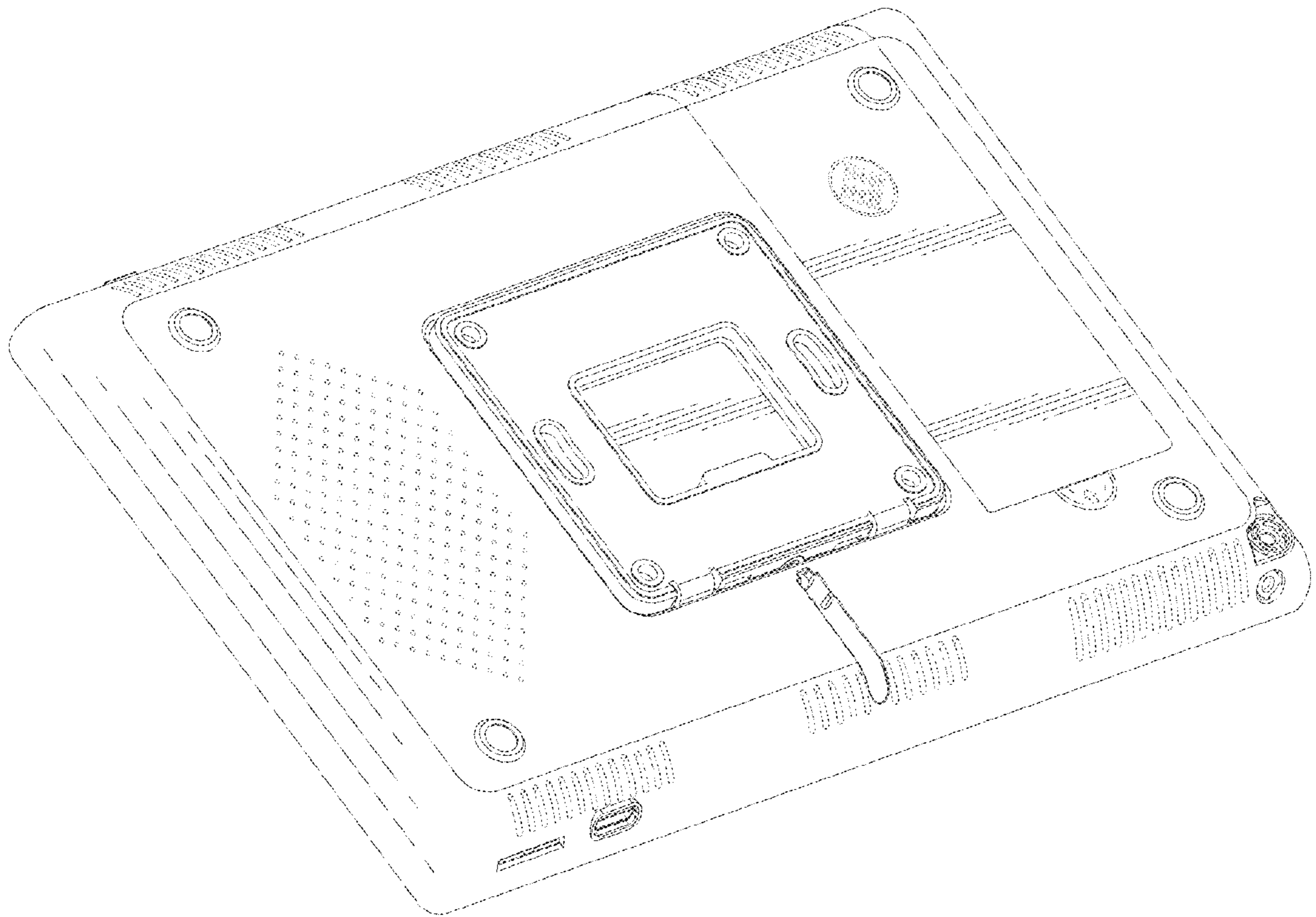

FIG. 8

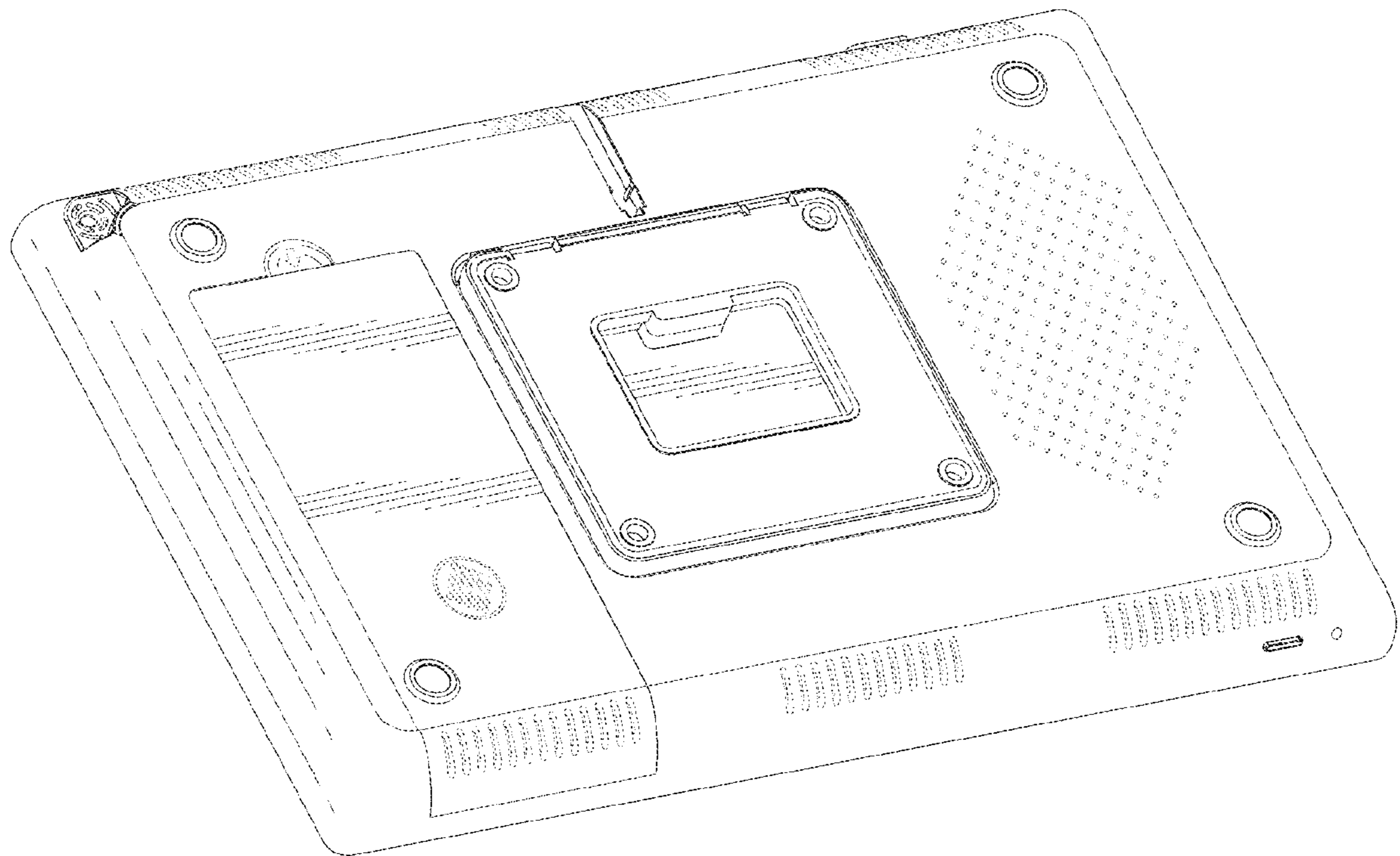

FIG. 9

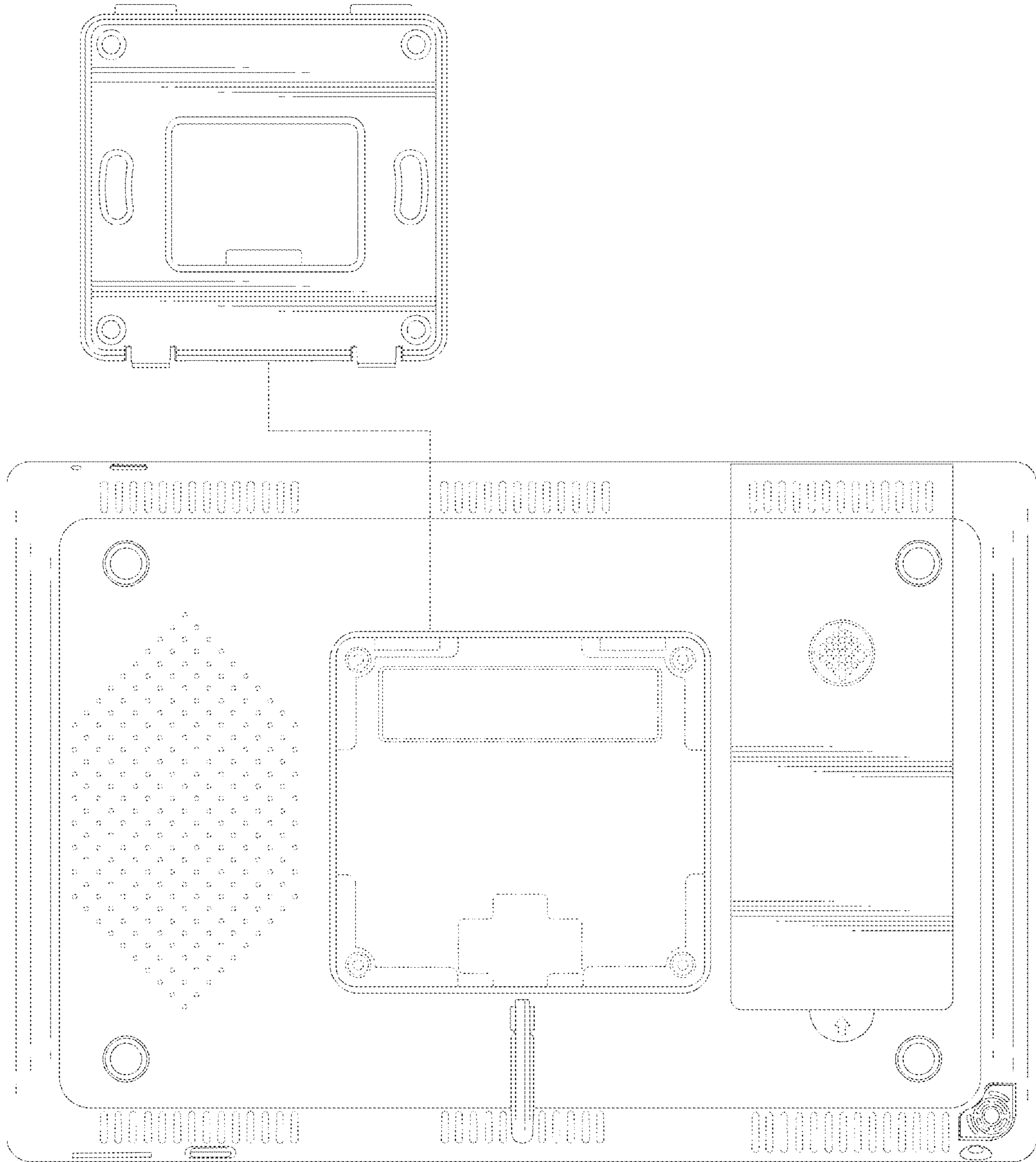

FIG. 10

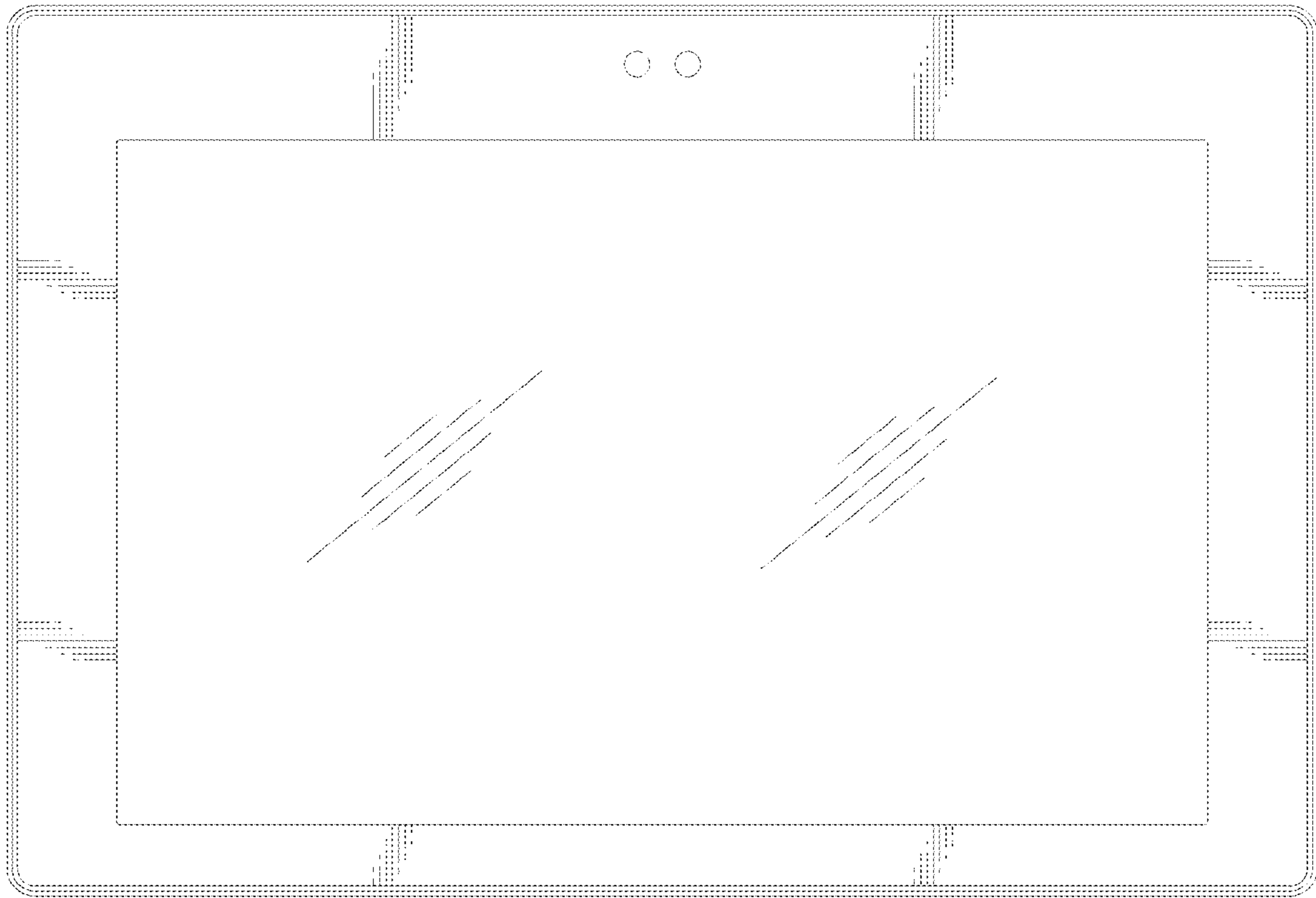

FIG. 11

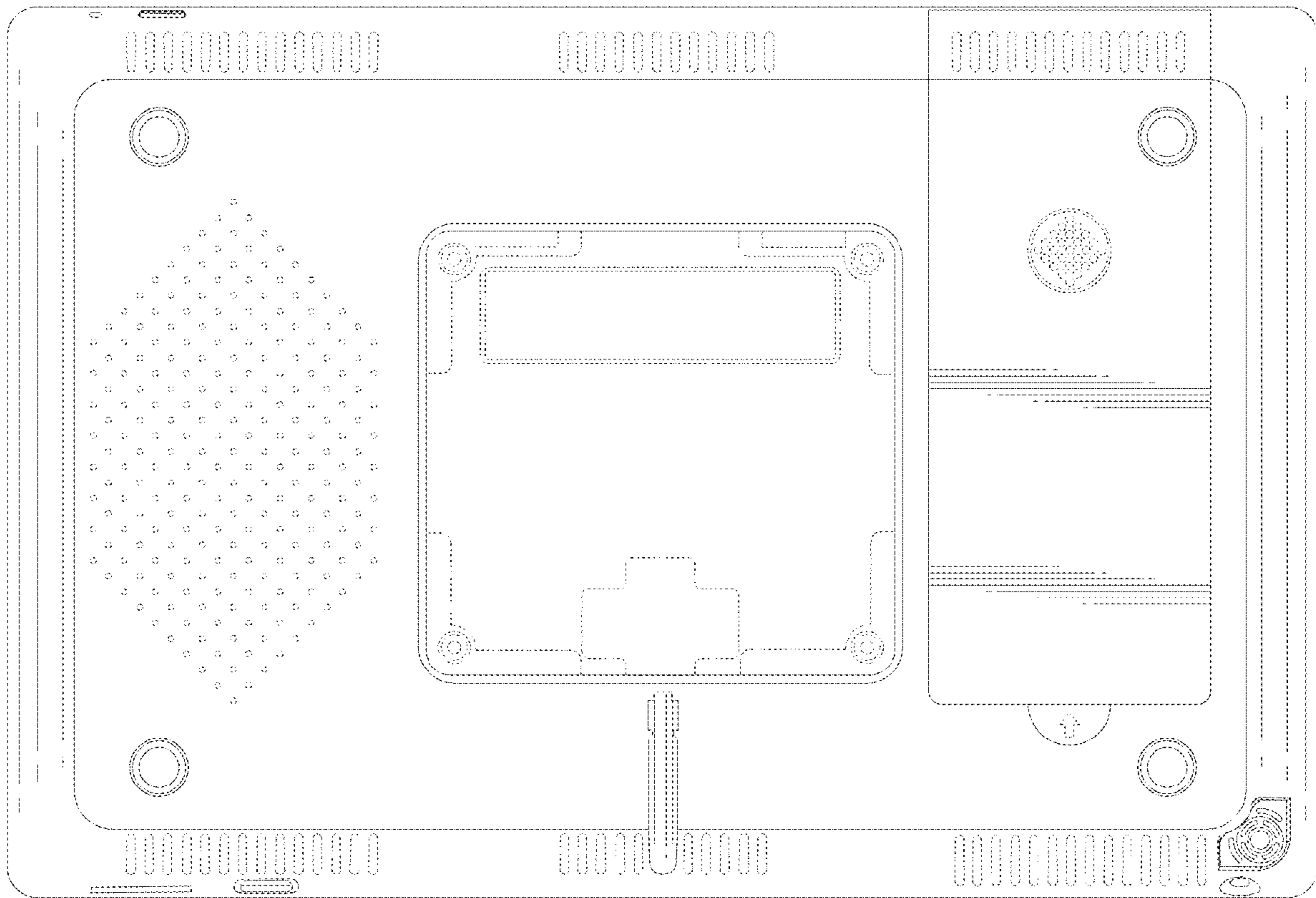

FIG. 12

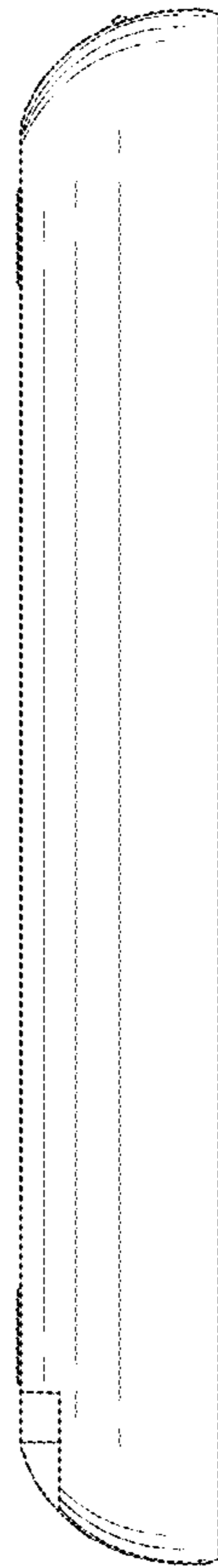

FIG. 13

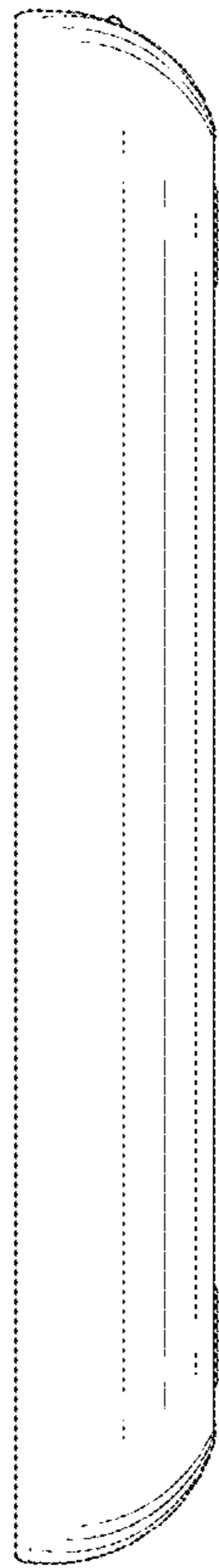

FIG. 14

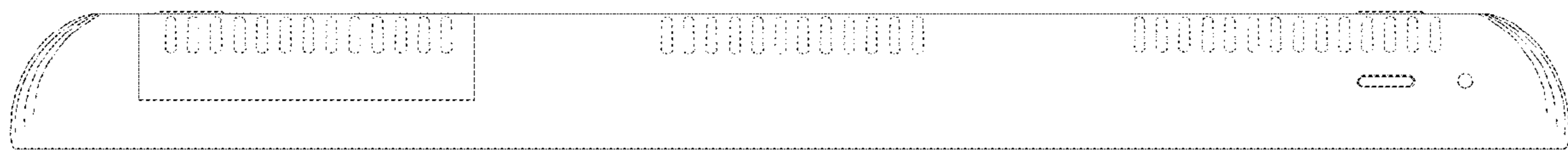

FIG. 15

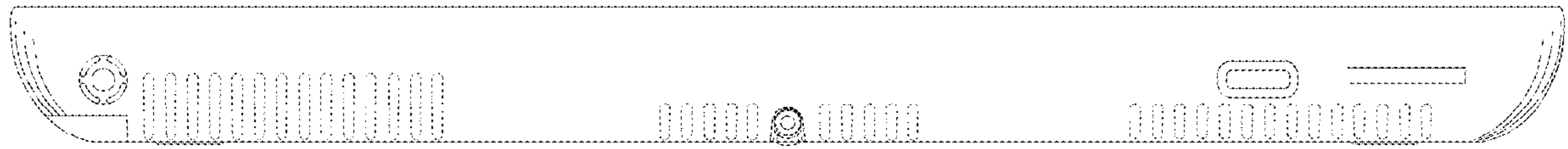

FIG. 16

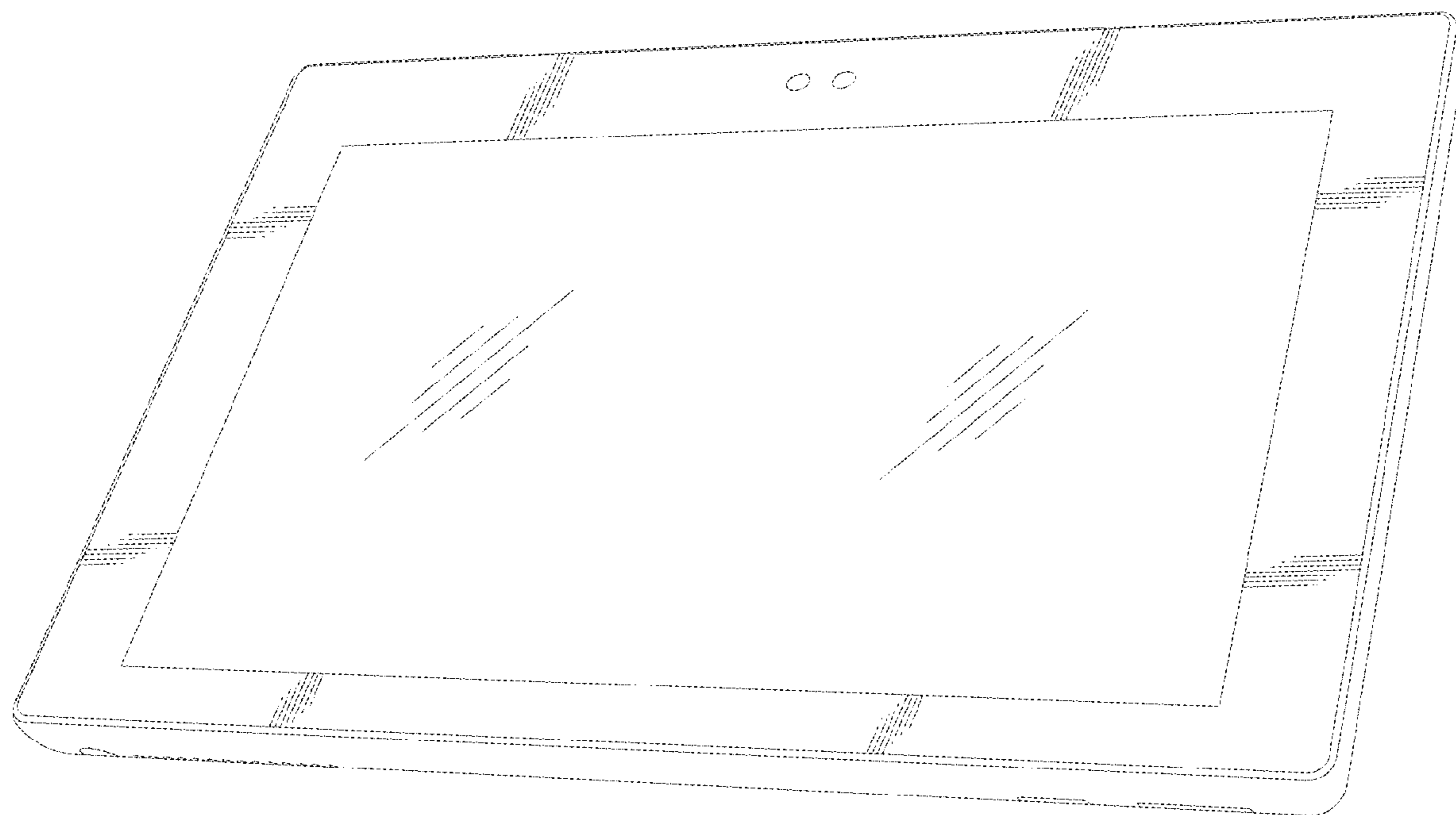

FIG. 17

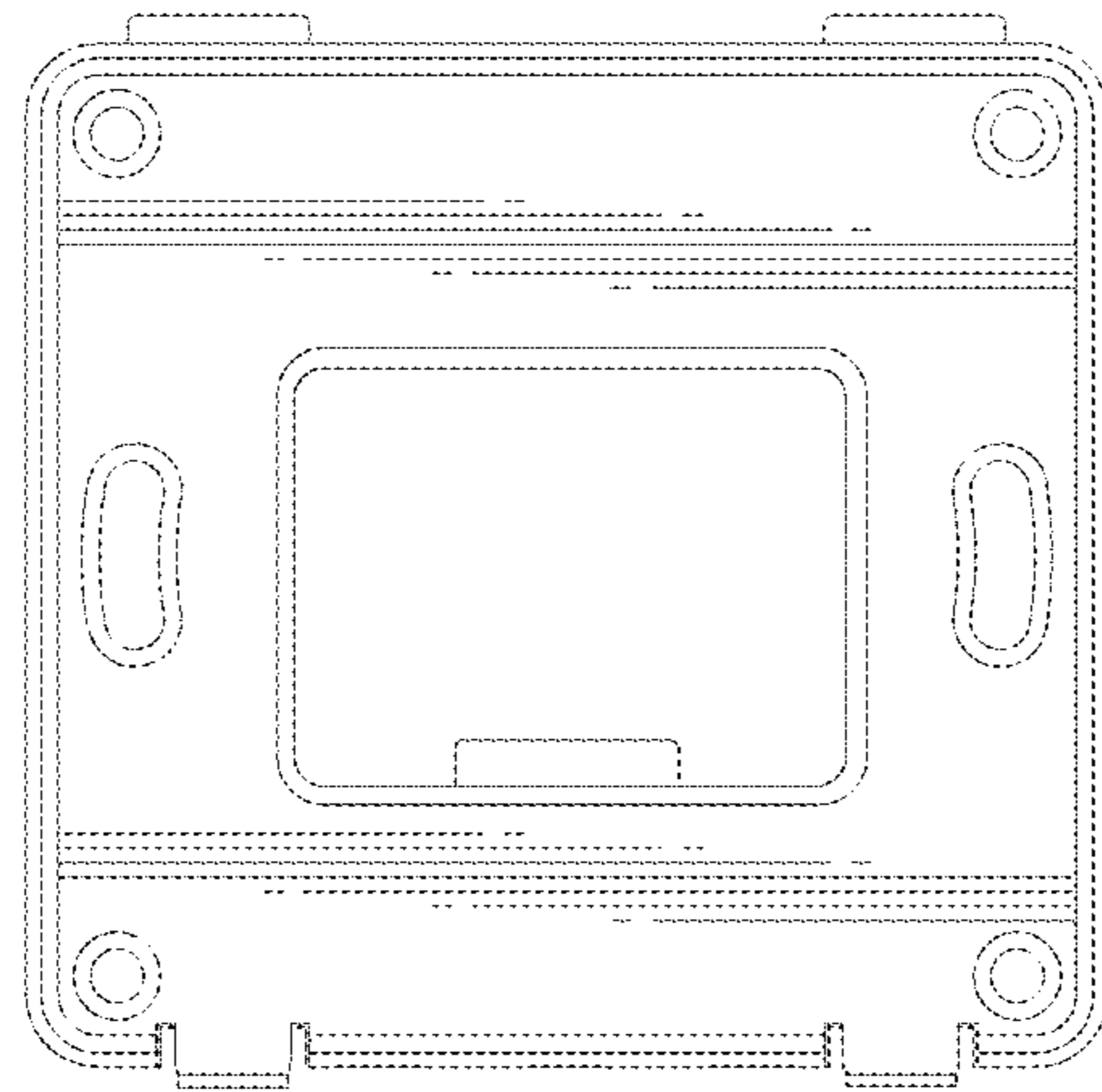

FIG. 18

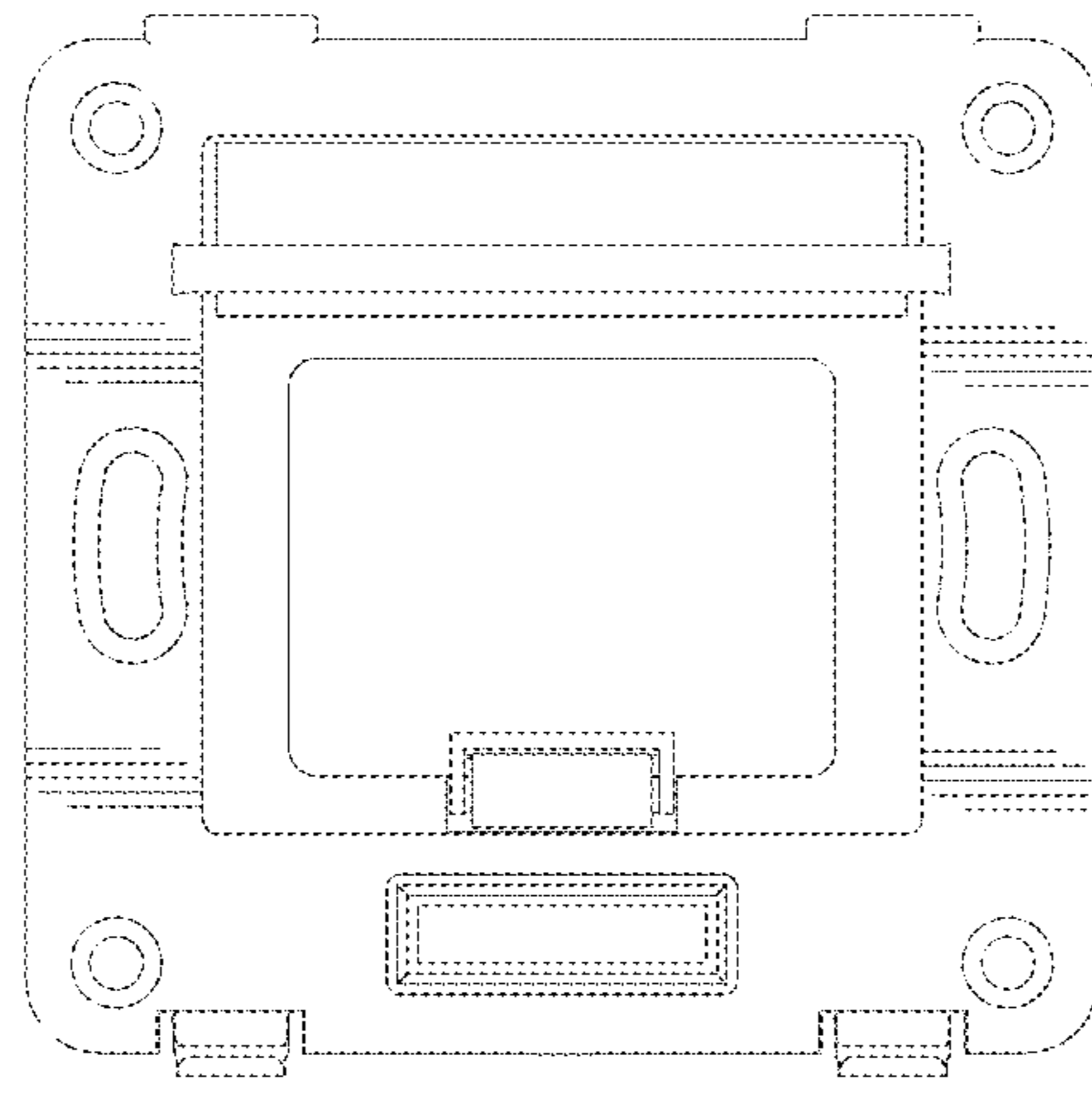

FIG. 19

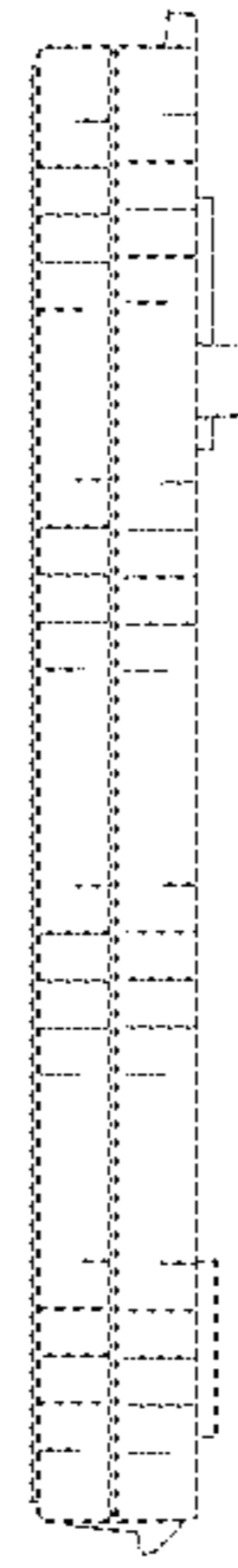

FIG. 20



FIG. 21

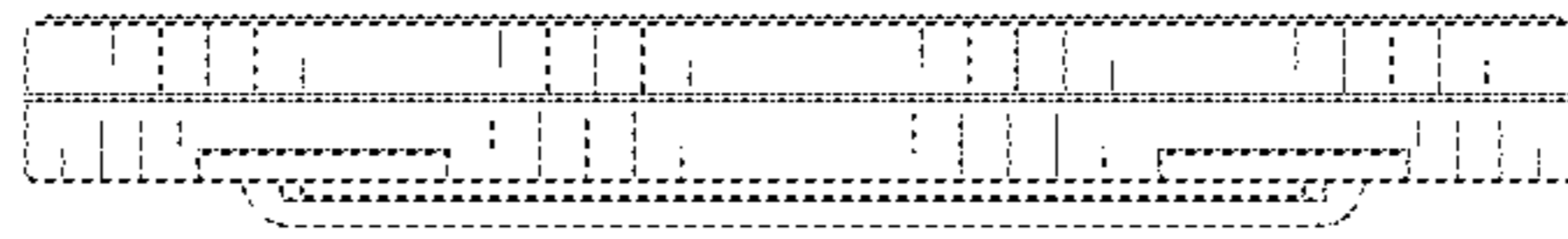

FIG. 22

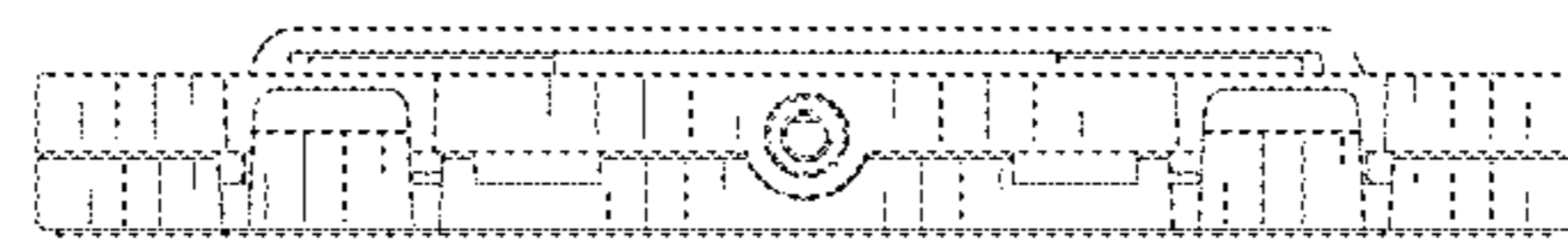

FIG. 23

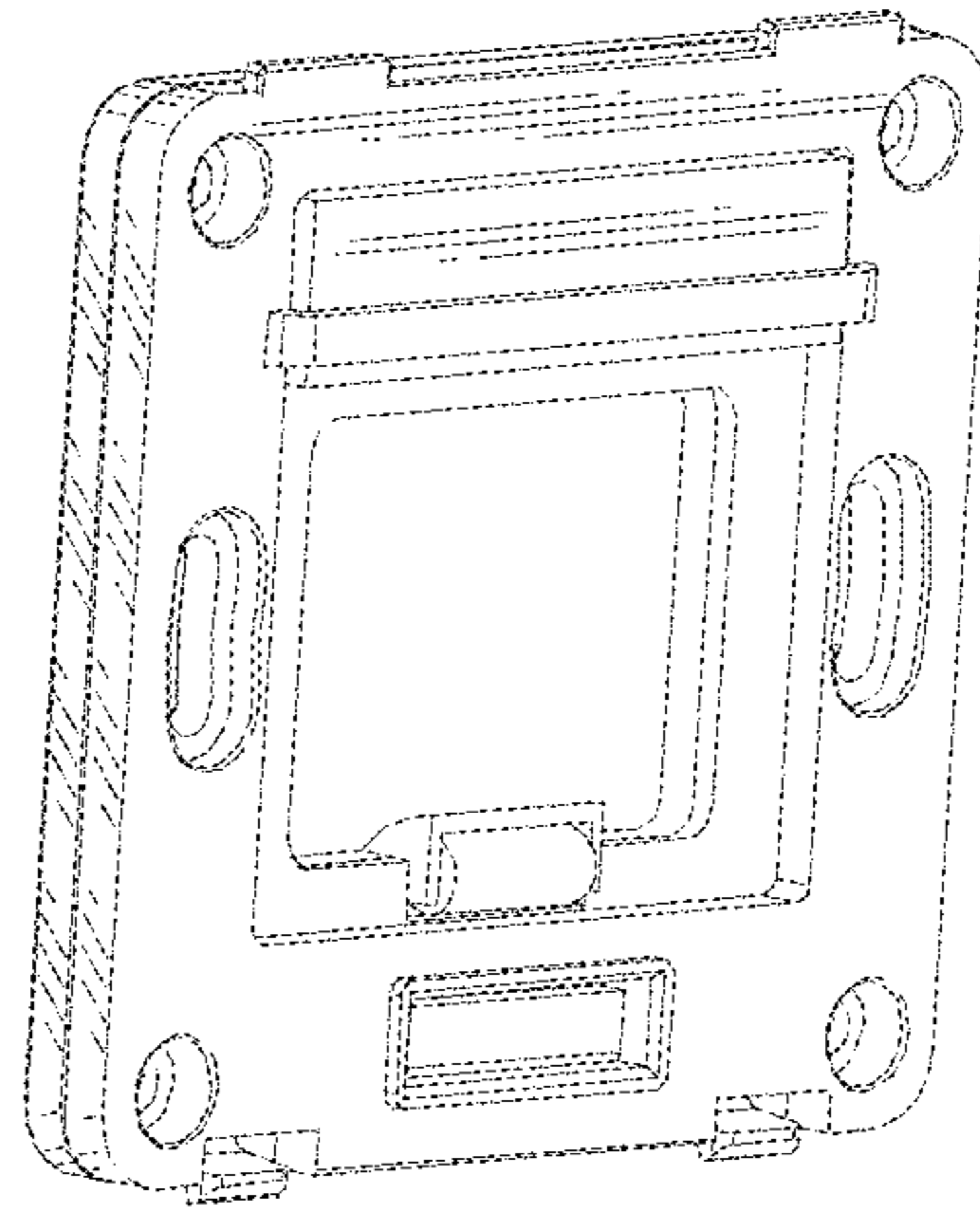

FIG. 24