



US00D947826S

(12) **United States Design Patent**
Kim et al.

(10) **Patent No.:** **US D947,826 S**
(45) **Date of Patent:** **** Apr. 5, 2022**

(54) **ELECTRONIC DEVICE**

FOREIGN PATENT DOCUMENTS

(71) Applicant: **Samsung Electronics Co., Ltd.**,
Suwon-si (KR)

WO WO-D213601-001 * 8/2021

(72) Inventors: **In-Shik Kim**, Suwon-si (KR); **Yun-Jin Kim**,
Suwon-si (KR); **Nam-Kyu Kim**, Suwon-si (KR); **Hae-Sung Park**,
Suwon-si (KR)

OTHER PUBLICATIONS

Samsung Galaxy Note20 Ultra pictures, official photos, released
Aug. 21, 2020, gsmarena.com [online], [retrieved Jan. 21, 2022],
available at URL: https://www.gsmarena.com/samsung_galaxy_note20_ultra-10355.php (Year: 2020).*

(73) Assignee: **SAMSUNG ELECTRONICS CO., LTD.**,
Suwon-si (KR)

(Continued)

(**) Term: **15 Years**

Primary Examiner — Wendy L Arminio

Assistant Examiner — Carrie S Gelula

(21) Appl. No.: **29/748,342**

(74) *Attorney, Agent, or Firm* — McAndrews Held &
Malloy, Ltd.

(22) Filed: **Aug. 28, 2020**

(30) **Foreign Application Priority Data**

Mar. 11, 2020 (KR) 30-2020-0010926

(51) **LOC (13) Cl.** **14-03**

(52) **U.S. Cl.**
USPC **D14/248**

(58) **Field of Classification Search**
USPC D14/248, 138 C, 138 R, 138 AC,
D14/138 AD, 38 AA, 138 G, 426,
D14/341-345; D10/30-38, 98; D16/244,
D16/245; D24/167, 186
CPC ... H04N 5/2257; G06F 1/1686; G06F 1/1605;
H01L 27/3232; G02B 13/001; H04M
1/0264
See application file for complete search history.

(57) **CLAIM**

The ornamental design for an electronic device, as shown
and described.

(56) **References Cited**

U.S. PATENT DOCUMENTS

D432,554 S * 10/2000 Matsumura D16/218
D513,505 S * 1/2006 Lee D14/138 AB
D537,432 S * 2/2007 Kim D14/138 AA
D578,500 S * 10/2008 Lee D14/138 G
D611,974 S * 3/2010 Kwon D16/202
D615,947 S * 5/2010 Park D14/138 G

(Continued)

DESCRIPTION

FIG. 1 is a front perspective view of an electronic device
showing our new design;
FIG. 2 is a front elevation view thereof;
FIG. 3 is a rear elevation view thereof;
FIG. 4 is a left side elevation view thereof;
FIG. 5 is a right side elevation view thereof;
FIG. 6 is a top plan view thereof;
FIG. 7 is a bottom plan view thereof;
FIG. 8 is a rear perspective view thereof; and,
FIG. 9 is an enlarged-exploded rear perspective view of a
portion of FIG. 8.
The dashed broken lines in the figures illustrate portions of
the electronic device that form no part of the claimed design.
The dot-dash broken lines in the figures define the bound-
aries of the claimed design and form no part thereof.

1 Claim, 9 Drawing Sheets

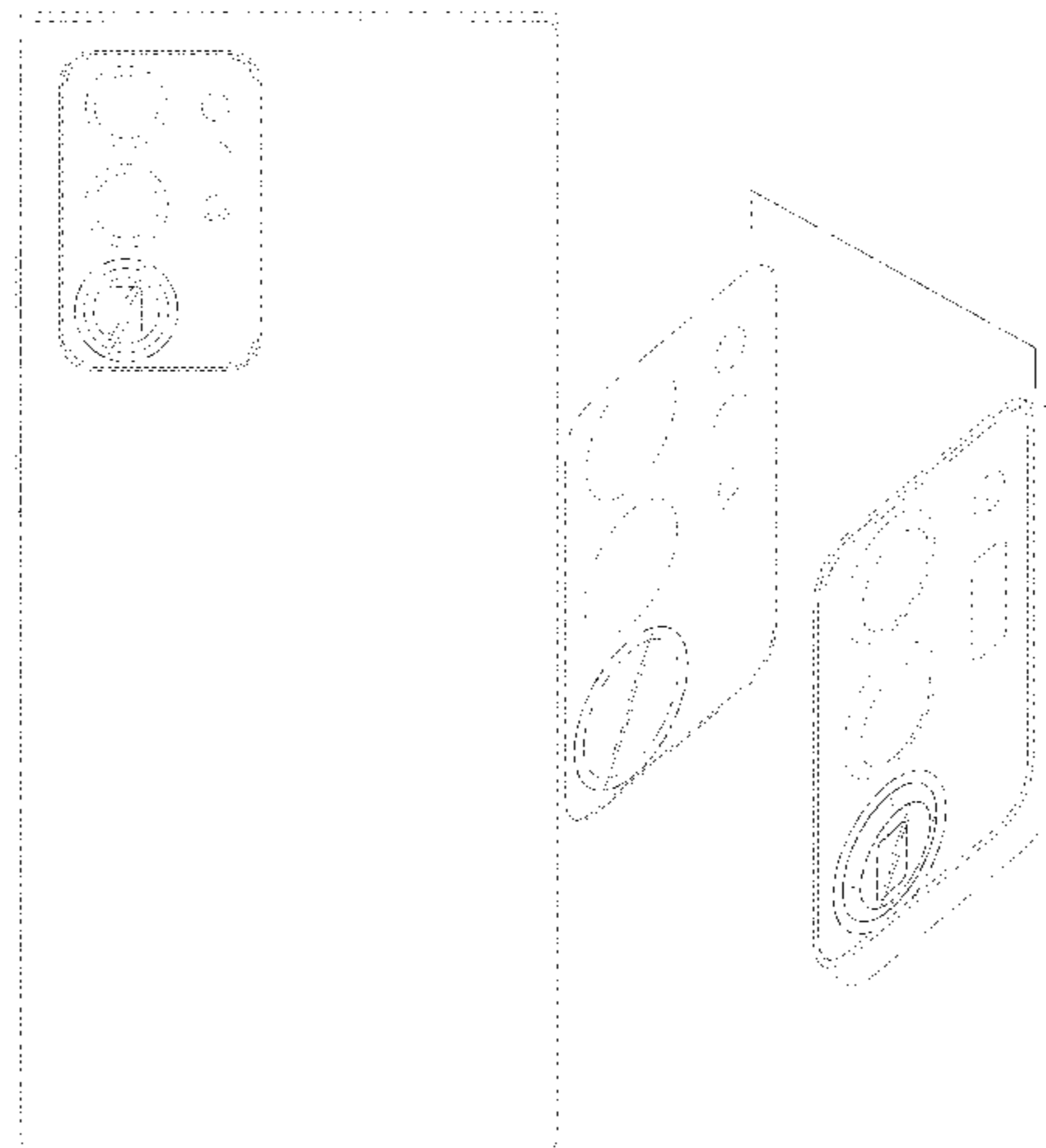

(56)

References Cited

U.S. PATENT DOCUMENTS

7,923,676 B2 * 4/2011 Kinoshita H04N 5/2257
250/208.1
8,013,934 B2 * 9/2011 Lin H04N 5/2256
348/376
D651,189 S * 12/2011 Tsai D14/138 G
D682,333 S * 5/2013 Kim D16/202
D695,328 S * 12/2013 Sul D16/202
D695,803 S * 12/2013 Kyunghan D16/202
D731,576 S * 6/2015 Ham D16/219
D742,847 S * 11/2015 Ryu D14/138 G
D771,026 S * 11/2016 Min D14/248
D800,708 S * 10/2017 Kim D14/248
D806,705 S * 1/2018 Akana D14/341
D810,062 S * 2/2018 Lee D14/248
10,051,161 B2 * 8/2018 Choi H04N 5/232935
D887,382 S * 6/2020 Park D14/138 G
D914,632 S * 3/2021 Kim D14/138 G

2007/0212062 A1 * 9/2007 Saiki H04N 1/00307
396/535
2014/0184838 A1 * 7/2014 Jang G03B 17/565
348/208.7
2015/0049202 A1 * 2/2015 Okabe H04N 5/2252
348/207.1
2015/0212293 A1 * 7/2015 Bang H04N 5/2257
348/360

OTHER PUBLICATIONS

Huawei P30 Pro pictures, official photos, released Mar. 26, 2019, gsmarena.com [online], [retrieved Jan. 21, 2022], available at URL: https://www.gsmarena.com/huawei_p30_pro-9635.php (Year: 2019).*
Motorola Edge 20 Pro—Full phone specifications, announced Jul. 29, 2021, gsmarena.com [online], retrieved Jan. 21, 2022], available at URL: https://www.gsmarena.com/motorola_edge_20_pro-11004.php (Year: 2021).*

* cited by examiner

FIG. 1

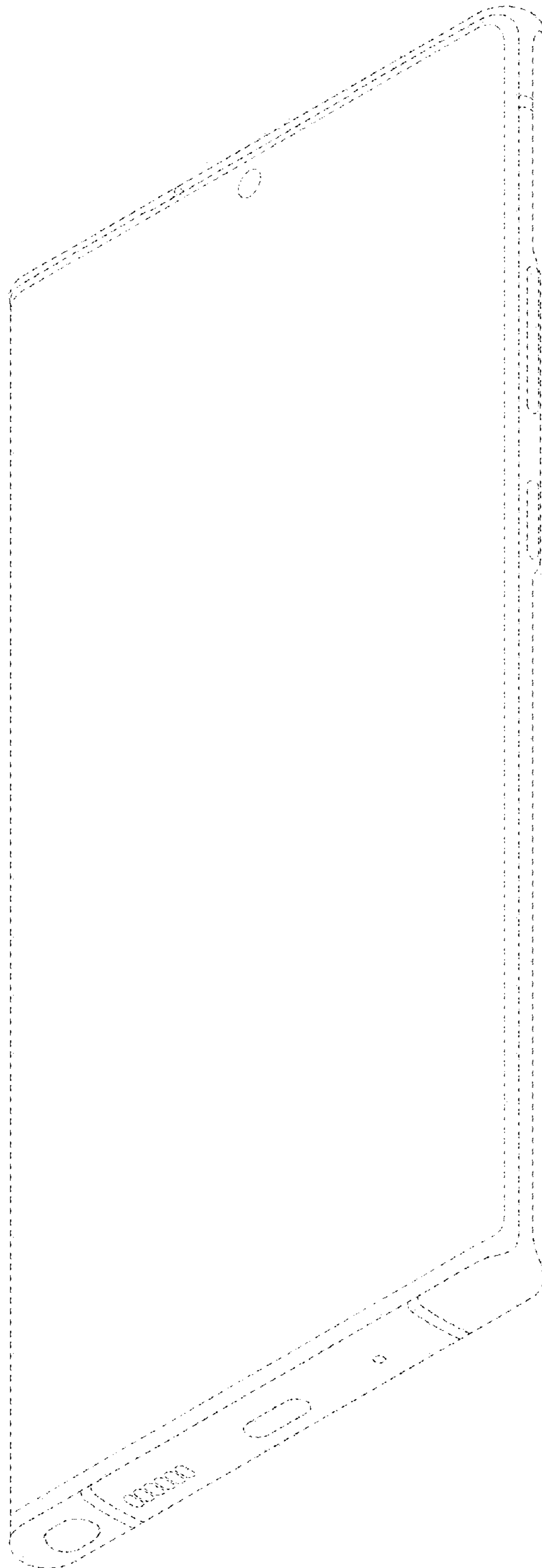

FIG. 2



FIG. 3

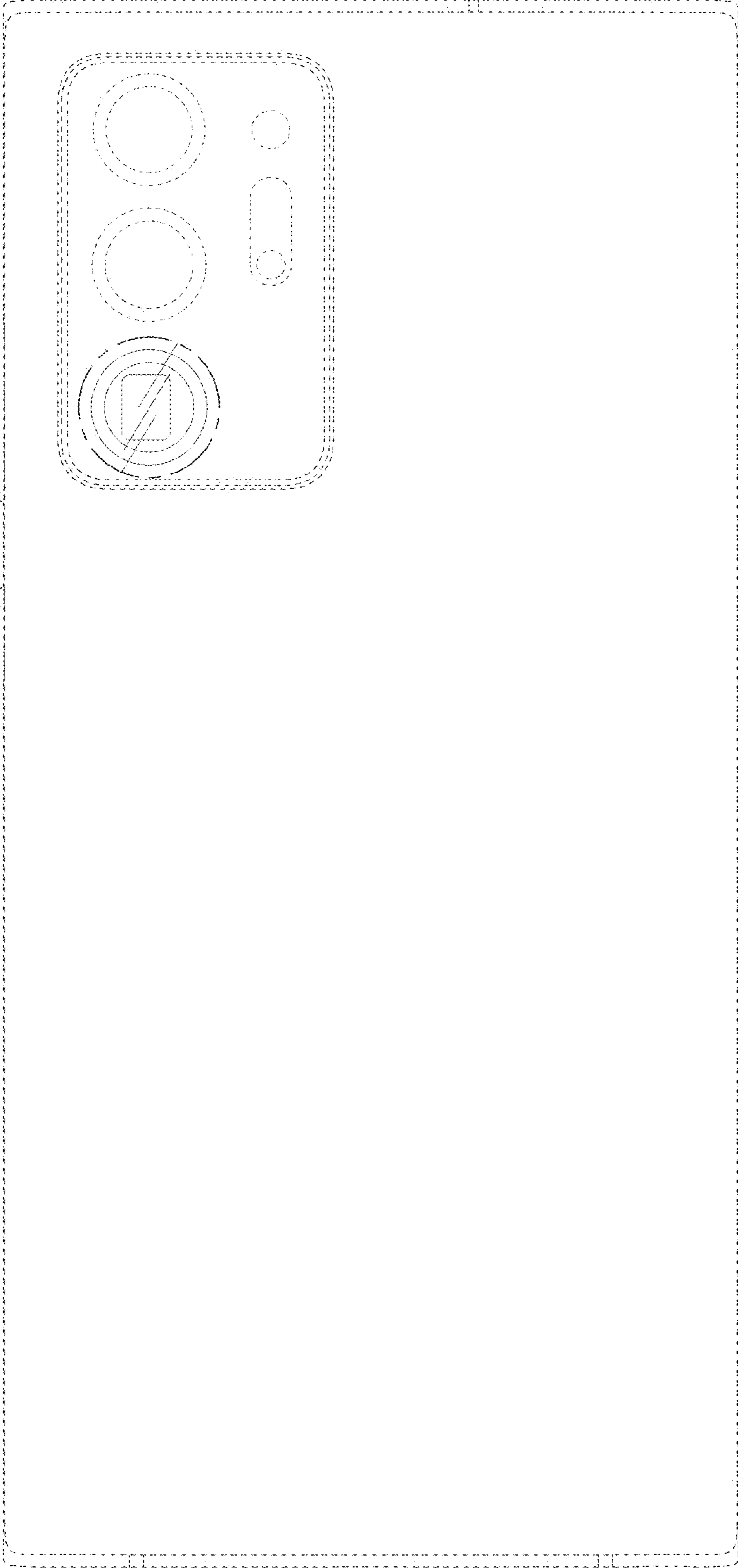

FIG. 4

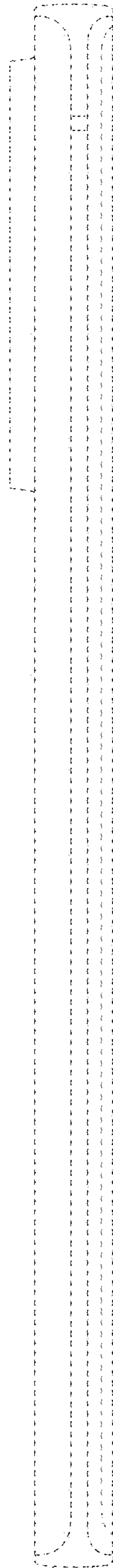

FIG. 5

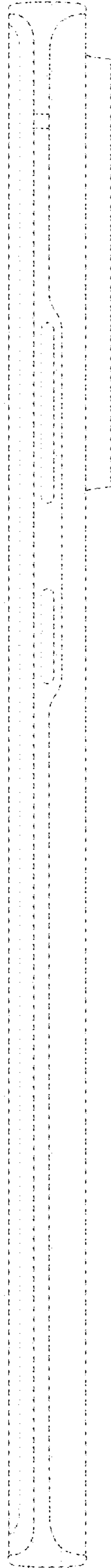

FIG. 6

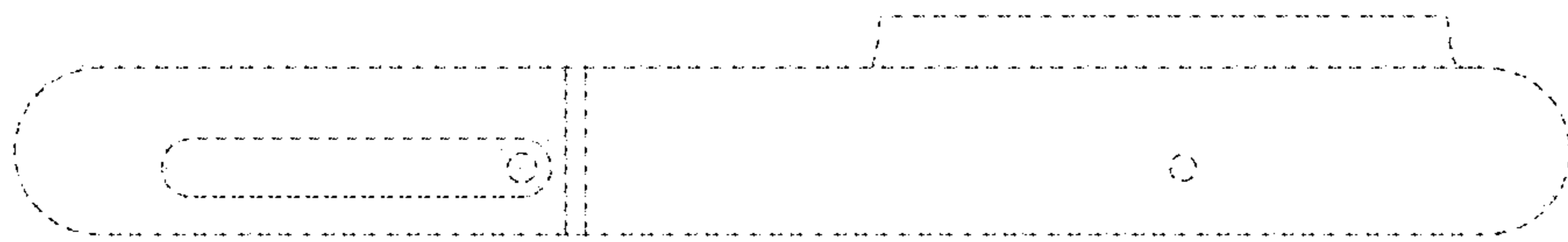

FIG. 7

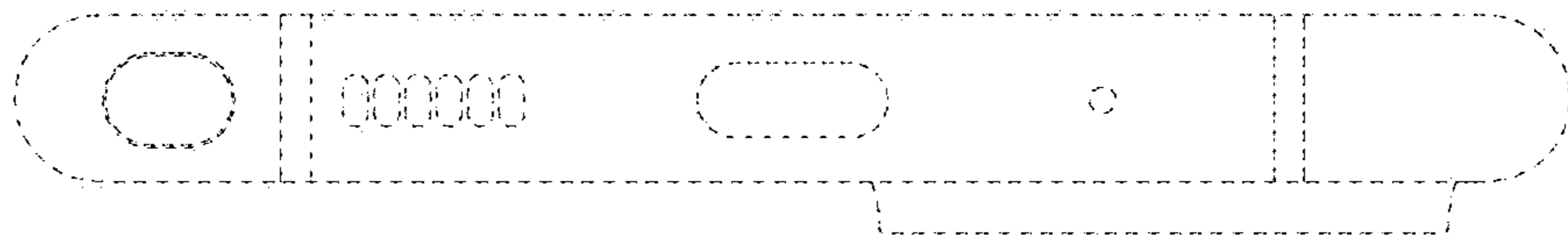

FIG. 8

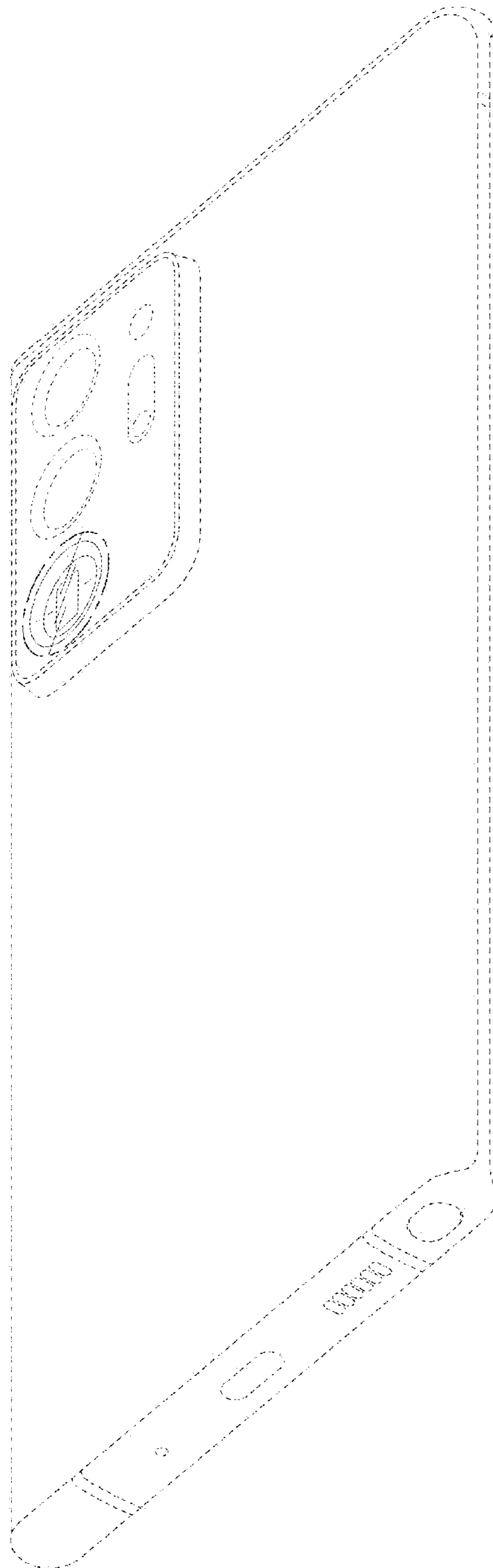

FIG. 9

