



US00D947794S

(12) **United States Design Patent** (10) **Patent No.:** **US D947,794 S**
Tan (45) **Date of Patent:** **** Apr. 5, 2022**

(54) **TEMPERATURE REGULATION UNIT**

D569,814 S 5/2008 Ikeda et al.
D570,793 S 6/2008 Ikeda et al.
D572,206 S 7/2008 Ikeda et al.
D647,884 S 11/2011 Moon et al.

(71) Applicant: **SG TRADEMARK HOLDING CO**
LLC, Brooklyn, NY (US)

(Continued)

(72) Inventor: **Xianbo Tan, Zhejiang (CN)**

FOREIGN PATENT DOCUMENTS

(**) Term: **15 Years**

CN 2873153 Y 2/2007
CN 2873153 2/2011

(21) Appl. No.: **29/776,034**

(Continued)

(22) Filed: **Mar. 26, 2021**

OTHER PUBLICATIONS

(51) **LOC (13) Cl.** **14-03**

(52) **U.S. Cl.**
USPC **D13/168; D10/49**

Kaz Feb. 19, 2021, "SoftHeat Moist/Dry Soothing Therapy Heating Pad, King Size". <https://www.newegg.com/kaz-hp218v1-moist-dry-soothing-therapy-heating-pad/p/N82E16887865001>.

(Continued)

(58) **Field of Classification Search**
USPC D10/49; D13/158, 168, 177; D14/218;
D24/133

CPC A61F 2007/0072; A61F 2007/0073; A61F
2007/0074; A61F 2007/0075; A61F
2007/0076; A61F 2007/0087; A61F
2007/0086; A61F 2007/0094; A61F
2007/0095

Primary Examiner — Antoine Duval Davis
(74) *Attorney, Agent, or Firm* — Wolf, Greenfield &
Sacks, P.C.

See application file for complete search history.

(57) **CLAIM**

The ornamental design for a temperature regulation unit, as shown and described.

(56) **References Cited**

U.S. PATENT DOCUMENTS

D301,694 S * 6/1989 Ahlers D10/49
5,432,322 A 7/1995 Ingram et al.
5,451,747 A 9/1995 Sullivan et al.
D451,077 S 11/2001 Montagnino et al.
D451,483 S 12/2001 Montagnino et al.
D454,869 S 3/2002 Becker et al.
D456,366 S 4/2002 Montagnino et al.
6,488,561 B2 * 12/2002 Weiner A61F 7/007
219/201
D480,370 S 10/2003 Kosumsuppamala et al.
D507,759 S 7/2005 Li
D510,046 S 9/2005 Li
D512,027 S 11/2005 Sarasjoki et al.
D531,587 S 11/2006 Poulet
D534,443 S * 1/2007 Moore D10/49
D559,813 S * 1/2008 Cho D14/138 AB

DESCRIPTION

FIG. 1 is a front perspective view of the temperature regulation unit showing the present design.
FIG. 2 is a front view thereof.
FIG. 3 is a rear view thereof.
FIG. 4 is a left side view thereof.
FIG. 5 is a right side view thereof.
FIG. 6 is a top view thereof; and,
FIG. 7 is a bottom view thereof.
The portions of the design shown in broken lines being for the purpose of illustrating environment only and form no part of the claimed design.

1 Claim, 4 Drawing Sheets

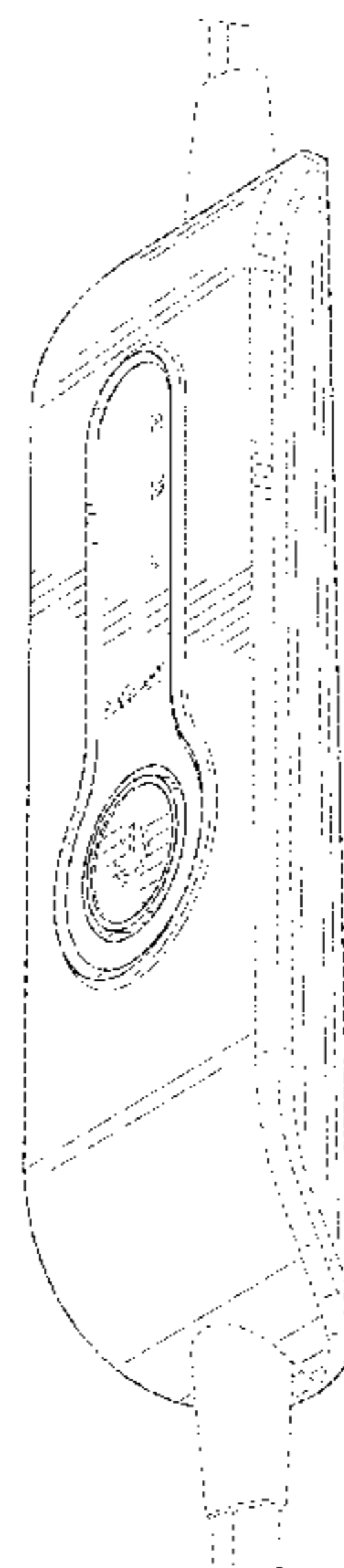

(56)

References Cited

FOREIGN PATENT DOCUMENTS

U.S. PATENT DOCUMENTS

D670,679 S 11/2012 Choi et al.
 D673,139 S 12/2012 Choi et al.
 D688,232 S 8/2013 Zhang
 D710,828 S 8/2014 Liu et al.
 D729,209 S 5/2015 McManigal et al.
 D760,177 S 6/2016 Gassner
 D760,668 S 7/2016 Mishan
 D772,821 S 11/2016 Bristol
 D790,484 S 6/2017 Bristol
 D805,484 S 12/2017 Bristol
 D811,371 S 2/2018 Meyer et al.
 D825,531 S 8/2018 Nokuo
 D827,587 S 9/2018 Hung
 D827,613 S 9/2018 Seo et al.
 D840,954 S 2/2019 Wu
 D856,307 S 8/2019 Maeda
 D856,979 S 8/2019 Seo et al.
 D862,421 S 10/2019 Arimoto
 D868,040 S * 11/2019 Desagre D14/218
 D873,222 S * 1/2020 Altonen D13/168
 D882,551 S 4/2020 Wang
 D909,994 S 2/2021 Bristol et al.
 D910,580 S 2/2021 Zhu
 D937,227 S * 11/2021 Thomsen A61F 7/007
 2020/0281046 A1 9/2020 Beuckelaere et al. D13/168

CN 303913618 11/2016
 CN 303913619 11/2016
 CN 304033560 2/2017
 CN 304439138 1/2018
 CN 209488836 U 10/2019
 CN 209488836 U 10/2019
 GB 1438371 A 6/1976
 KR 300711235.0000 10/2013

OTHER PUBLICATIONS

SoftHeat. Feb. 19, 2021, "Preffered Plus Heating pad Moist/Dry Therapy". <https://www.amazon.com/SoftHeat-Preffered-Heating-Moist-therapy/dp/B0000E3J9F>.
 RyanPharmacy, Feb. 19, 2021, "Select Heat Switch Heating Pad". <http://ryanpharmacy.com/select-heat-switch-heating-pad/>.
 Cara, Feb. 19, 2021, "50 Heating Pad, Dry, Standard". <https://www.amazon.com/CARA-Heating-Pad-Dry-Standard/dp/B00164X9XO>.
 KB Basics™, Feb. 19, 2021, "Heating Pad". https://shop.kingbrand.com/product_info.php?products_id=250.
 SunBeam, Feb. 19, 2021, "Electric Heated Velvet Plush Deluxe Throw XL Dual Pocket Blanket Slate Grey Washable Auto Shut Off 3 Heat Settings". <https://www.amazon.com/dp/B086MF35R5?tag=lurker0c-20>.

* cited by examiner

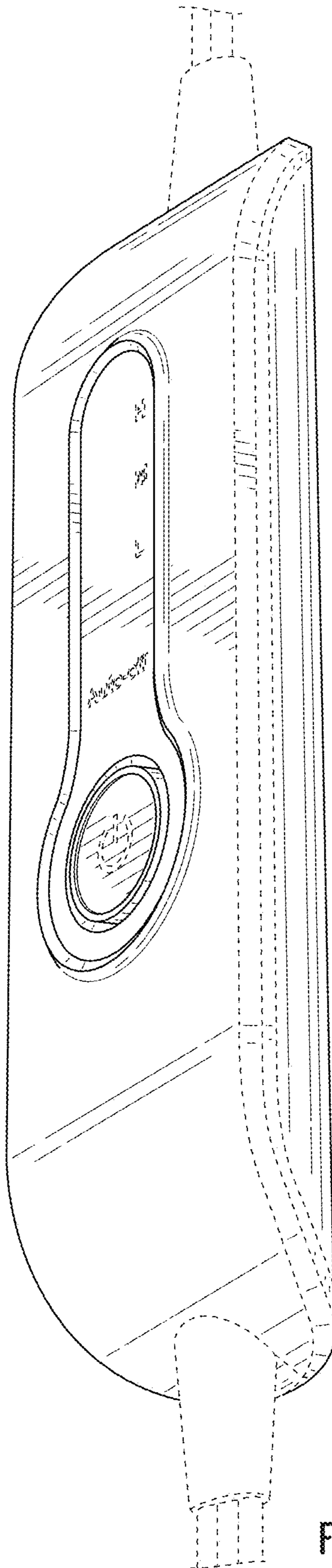

FIG. 1

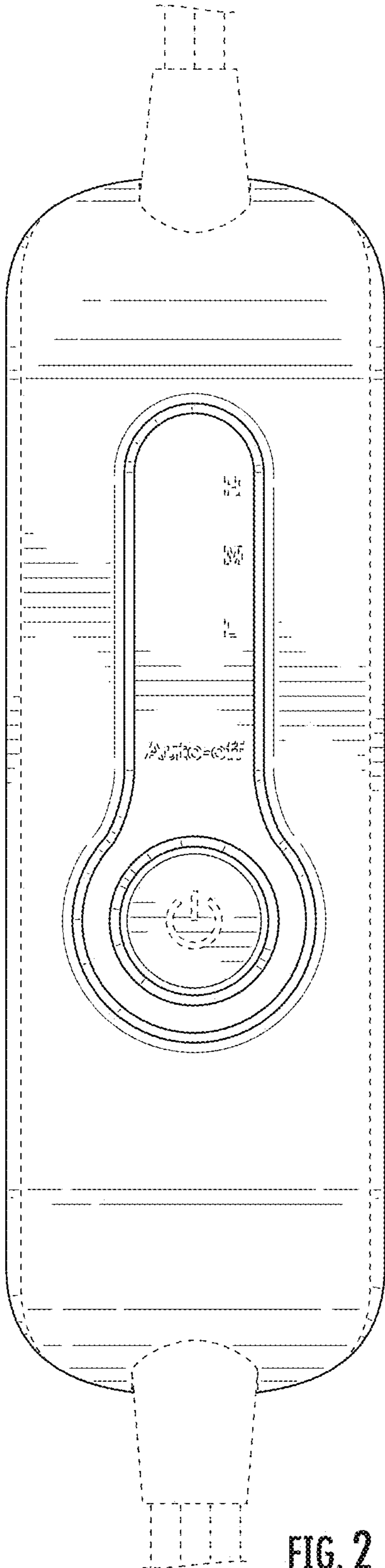

FIG. 2

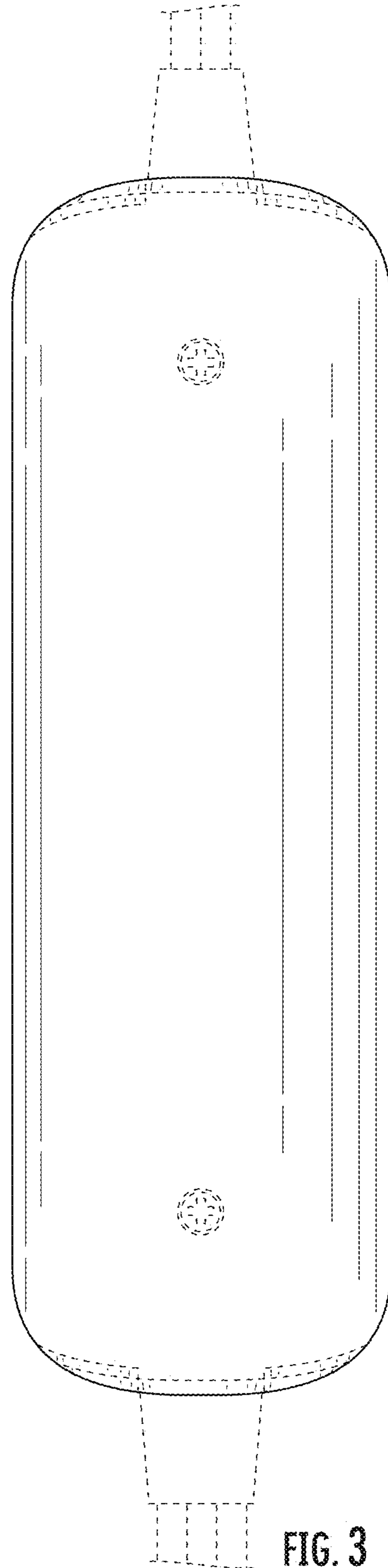

FIG. 3

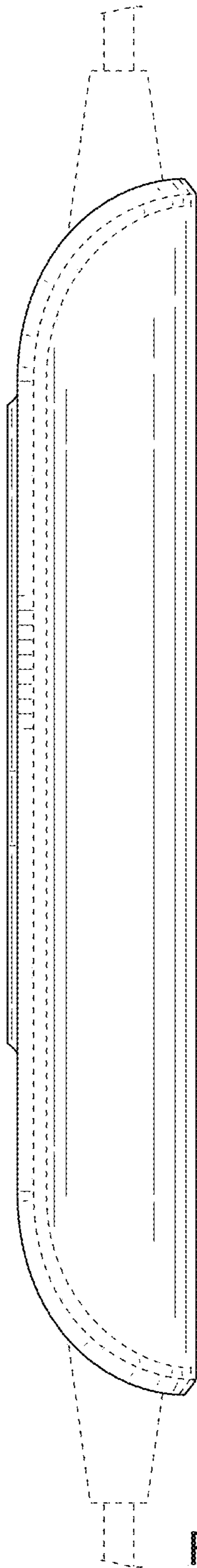

FIG. 4

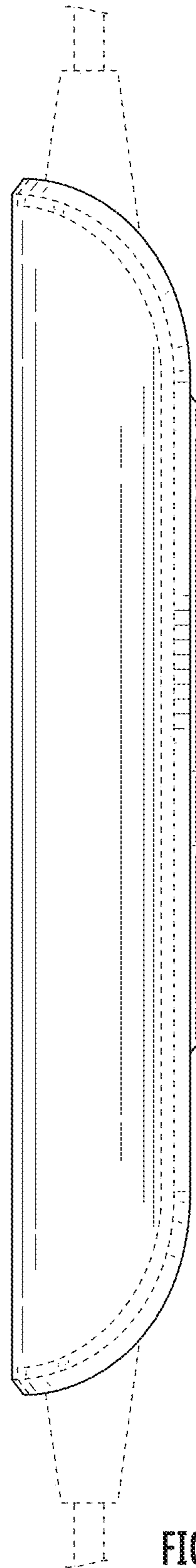

FIG. 5

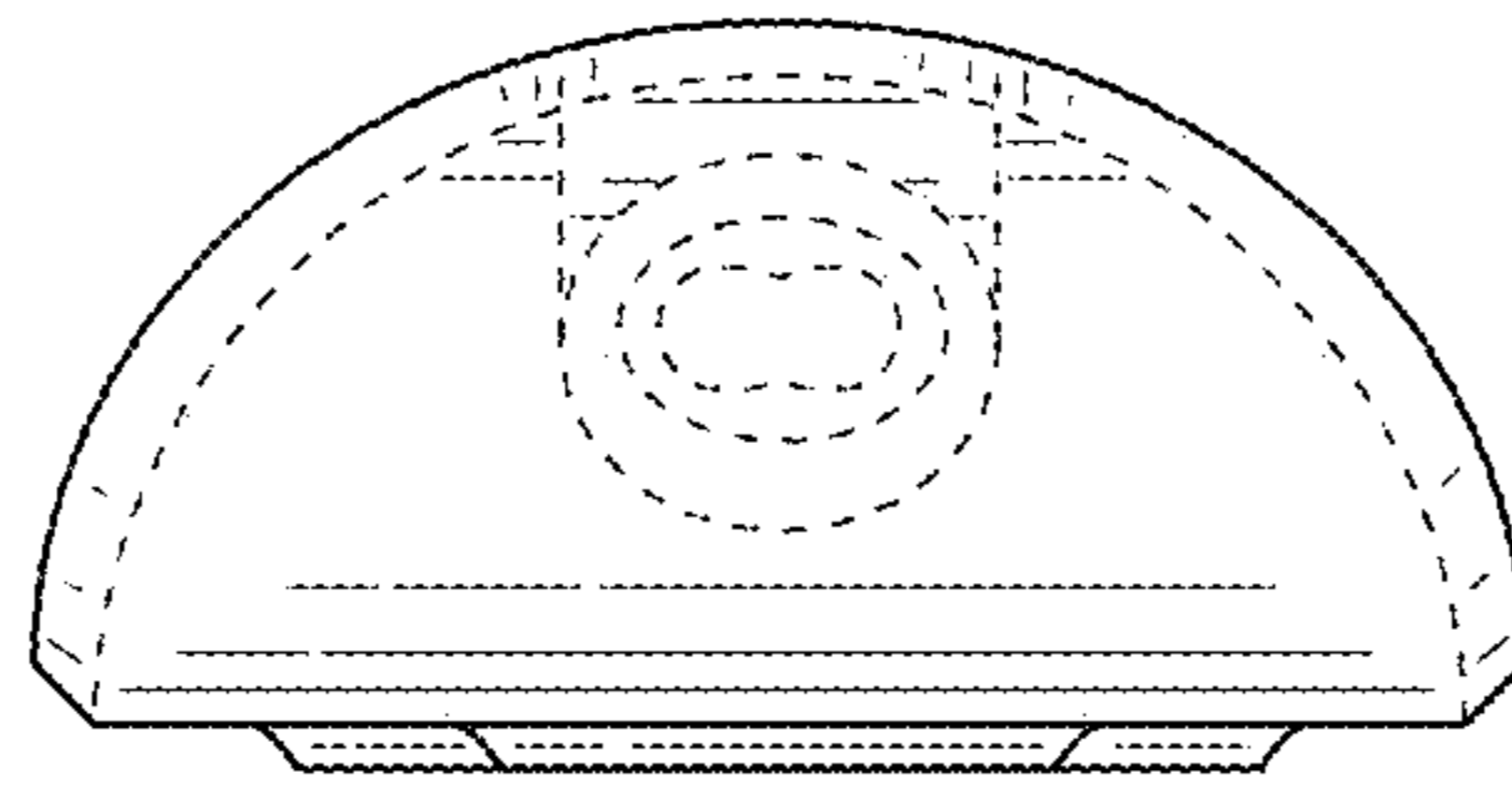

FIG. 6

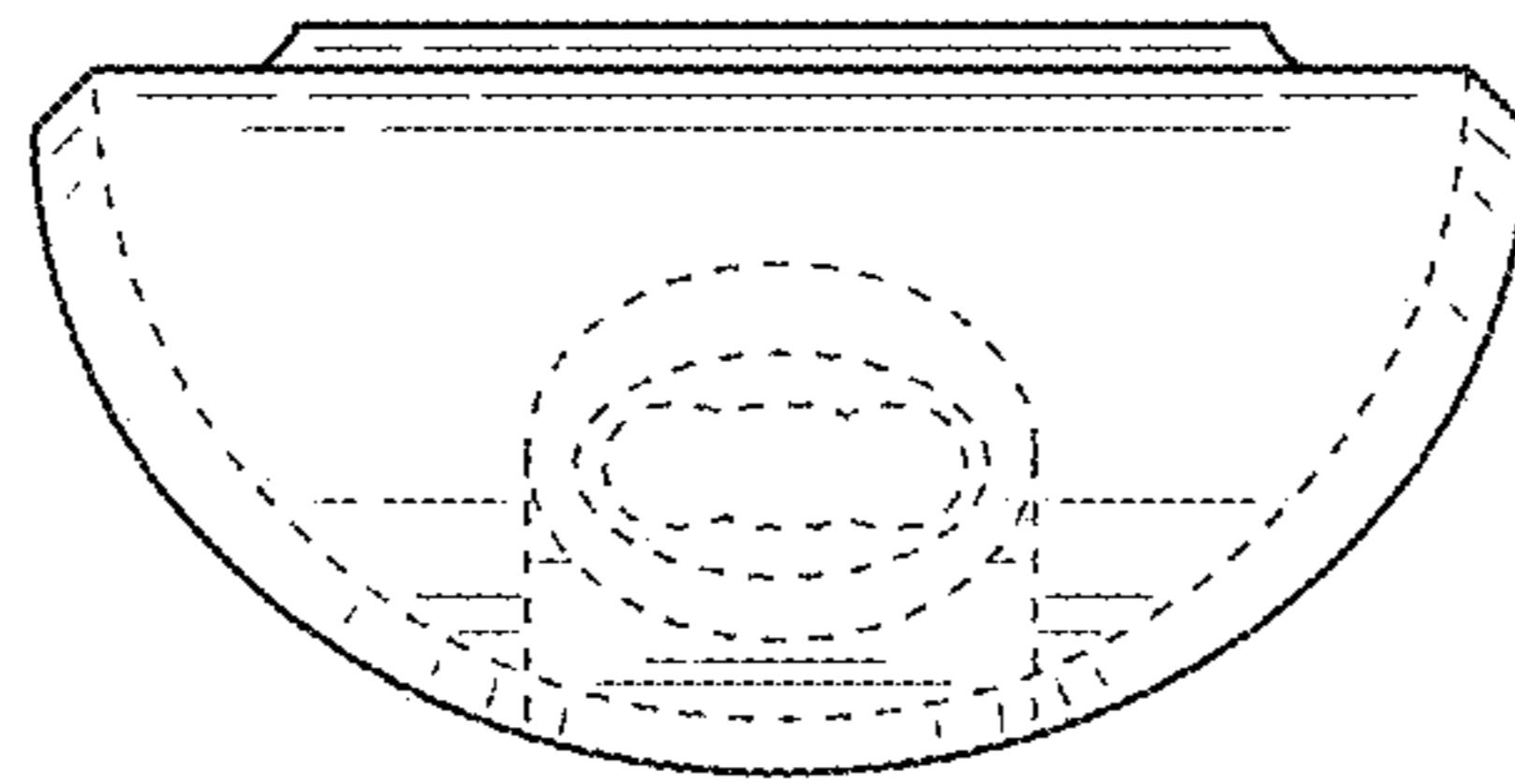

FIG. 7