

US00D947652S

(12) **United States Design Patent** (10) **Patent No.:** **US D947,652 S**  
**Noble** (45) **Date of Patent:** **\*\* Apr. 5, 2022**

(54) **CARABINER**  
(71) Applicant: **5.11, Inc.**, Manteca, CA (US)  
(72) Inventor: **Matthew David Noble**, Long Beach, CA (US)  
(73) Assignee: **5.11, Inc.**, Manteca, CA (US)  
(\*\*) Term: **15 Years**  
(21) Appl. No.: **29/693,964**  
(22) Filed: **Jun. 6, 2019**  
(51) **LOC (13) Cl.** ..... **09-06**  
(52) **U.S. Cl.**  
USPC ..... **D8/356**  
(58) **Field of Classification Search**  
USPC ..... D8/356, 354, 105, 349; D3/207  
CPC ..... B65H 57/16; B63B 21/045; A63B 29/08;  
A63B 27/02  
See application file for complete search history.

D833,855 S \* 11/2018 Page ..... D8/356  
D843,814 S \* 3/2019 Cariano ..... D8/356  
D873,112 S \* 1/2020 Bond ..... D8/105  
10,655,854 B2 \* 5/2020 Mojica ..... F16B 45/02  
D896,046 S \* 9/2020 Spater ..... D8/16  
D918,692 S \* 5/2021 Adelman ..... D8/105  
D933,354 S \* 10/2021 Grossman ..... D3/207  
D933,355 S \* 10/2021 Grossman ..... D3/207  
D934,662 S \* 11/2021 Adelman ..... D8/356  
D934,663 S \* 11/2021 Adelman ..... D8/356  
2007/0050956 A1 \* 3/2007 Hu ..... F16B 45/02  
24/598.2  
2007/0261213 A1 \* 11/2007 Nolan ..... A45F 3/14  
24/300  
2014/0059782 A1 \* 3/2014 Duncan ..... B25F 1/00  
7/138

\* cited by examiner

*Primary Examiner* — Cynthia R Underwood  
(74) *Attorney, Agent, or Firm* — Knobbe Martens Olson & Bear LLP

(57) **CLAIM**

The ornamental design for a carabiner, as shown and described.

**DESCRIPTION**

FIG. 1 is a perspective view showing front, right and top surfaces of a carabiner.  
FIG. 2 is a front view thereof.  
FIG. 3 is a rear view thereof.  
FIG. 4 is a left side view thereof.  
FIG. 5 is a right side view thereof.  
FIG. 6 is a top view thereof; and,  
FIG. 7 is a bottom view thereof.

**1 Claim, 5 Drawing Sheets**

(56) **References Cited**

**U.S. PATENT DOCUMENTS**

D444,685 S 7/2001 Shenkel et al.  
D580,257 S \* 11/2008 Squyres ..... D8/349  
D626,393 S 11/2010 Ormsbee  
D646,556 S 10/2011 Kelleghan  
D739,713 S \* 9/2015 Kelleghan ..... D8/356  
D765,495 S \* 9/2016 Schmid ..... D8/356  
D770,250 S \* 11/2016 Fischer ..... D8/17  
D772,029 S \* 11/2016 Spater ..... D8/18  
D808,240 S \* 1/2018 Kelleghan ..... D8/105  
D813,016 S \* 3/2018 Deneau ..... D8/356  
D821,090 S \* 6/2018 Case ..... D3/207

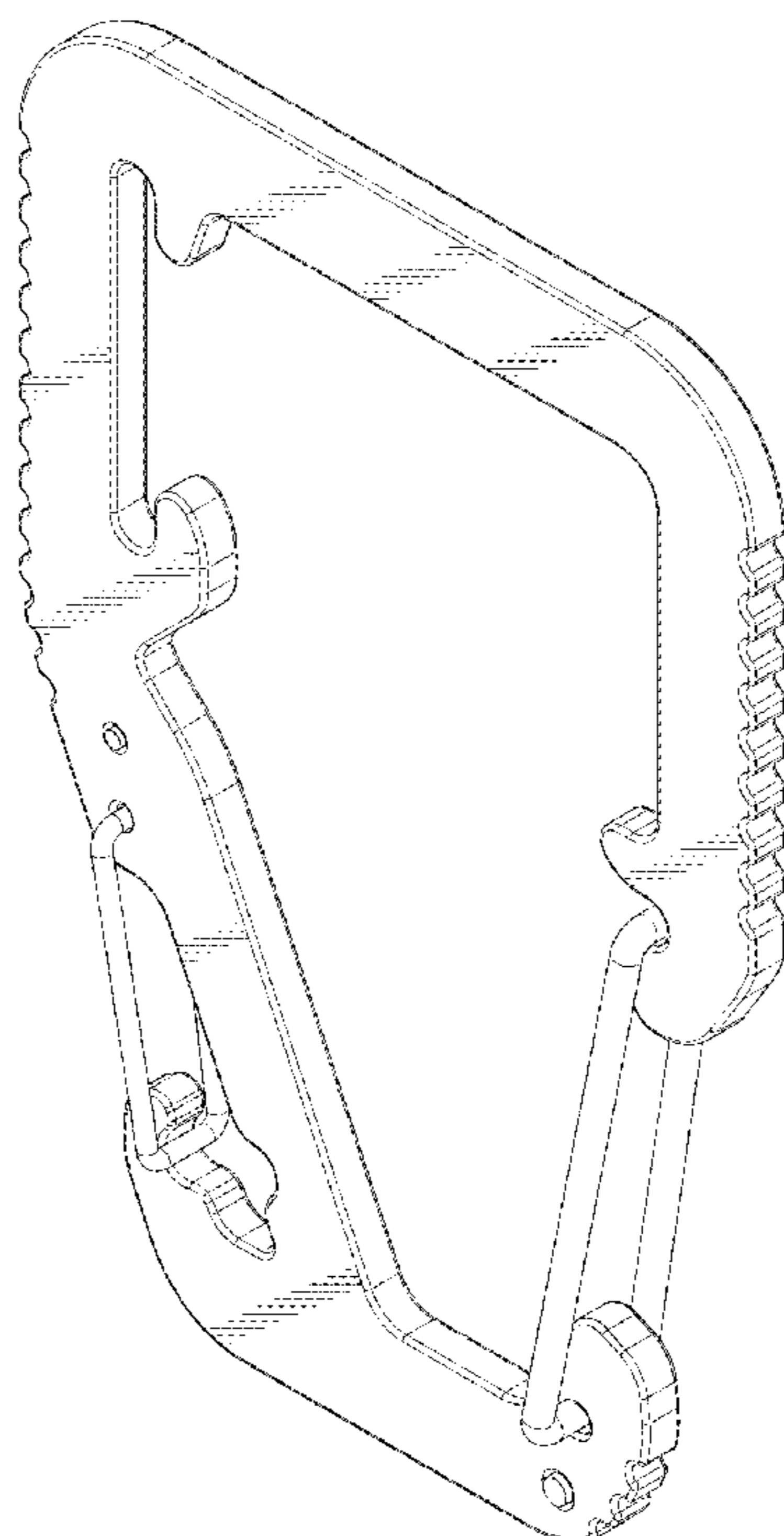

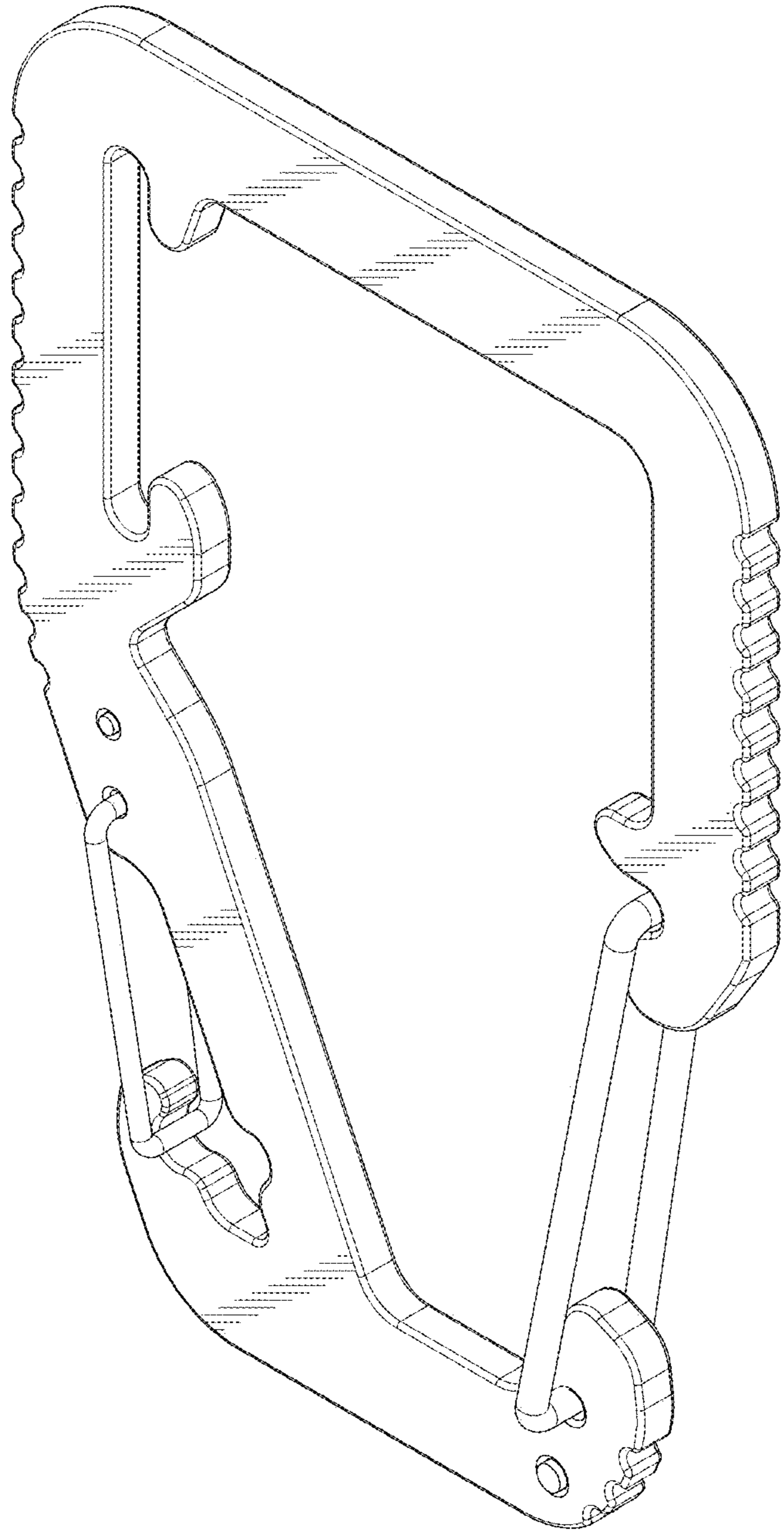

*FIG. 1*

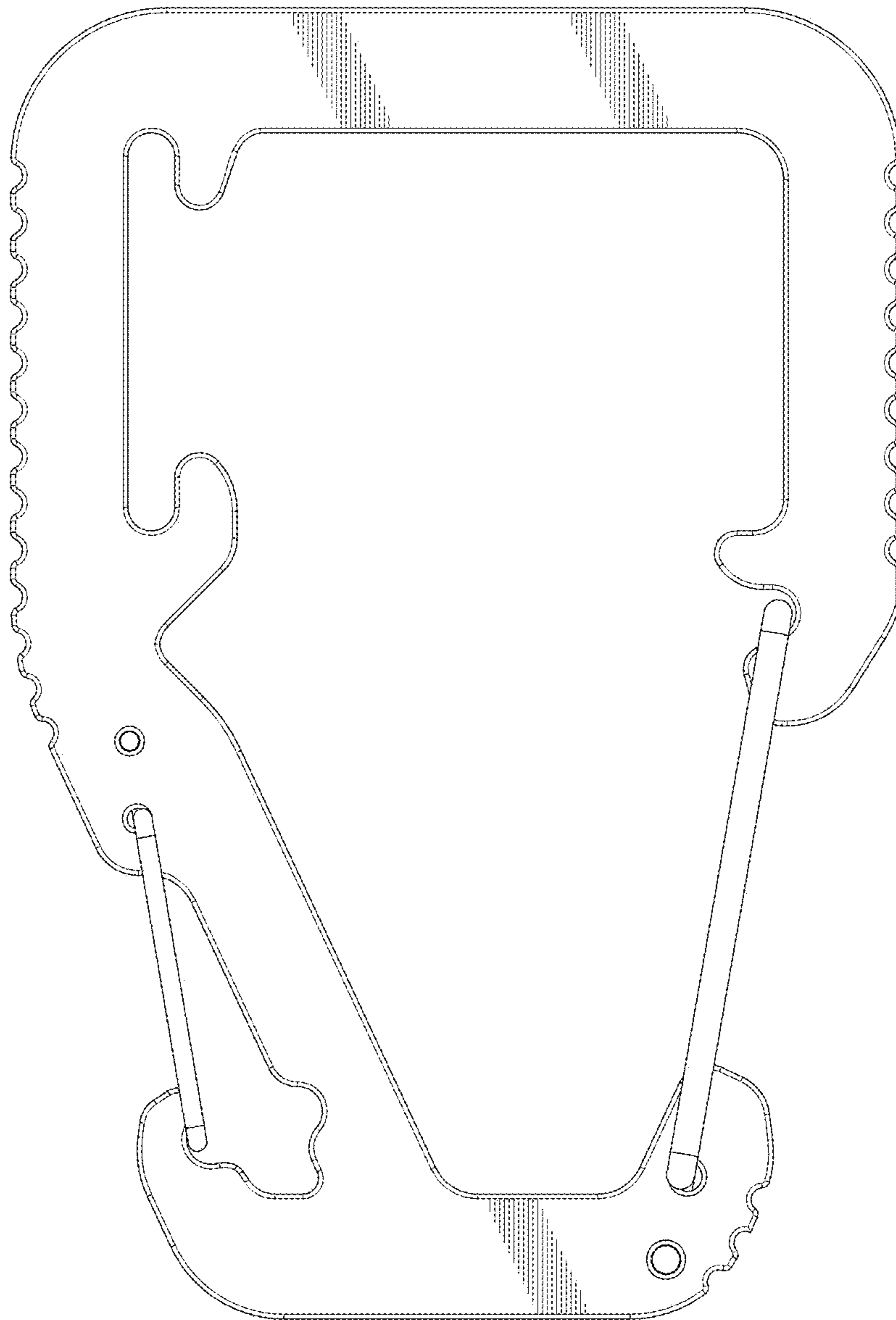

FIG. 2

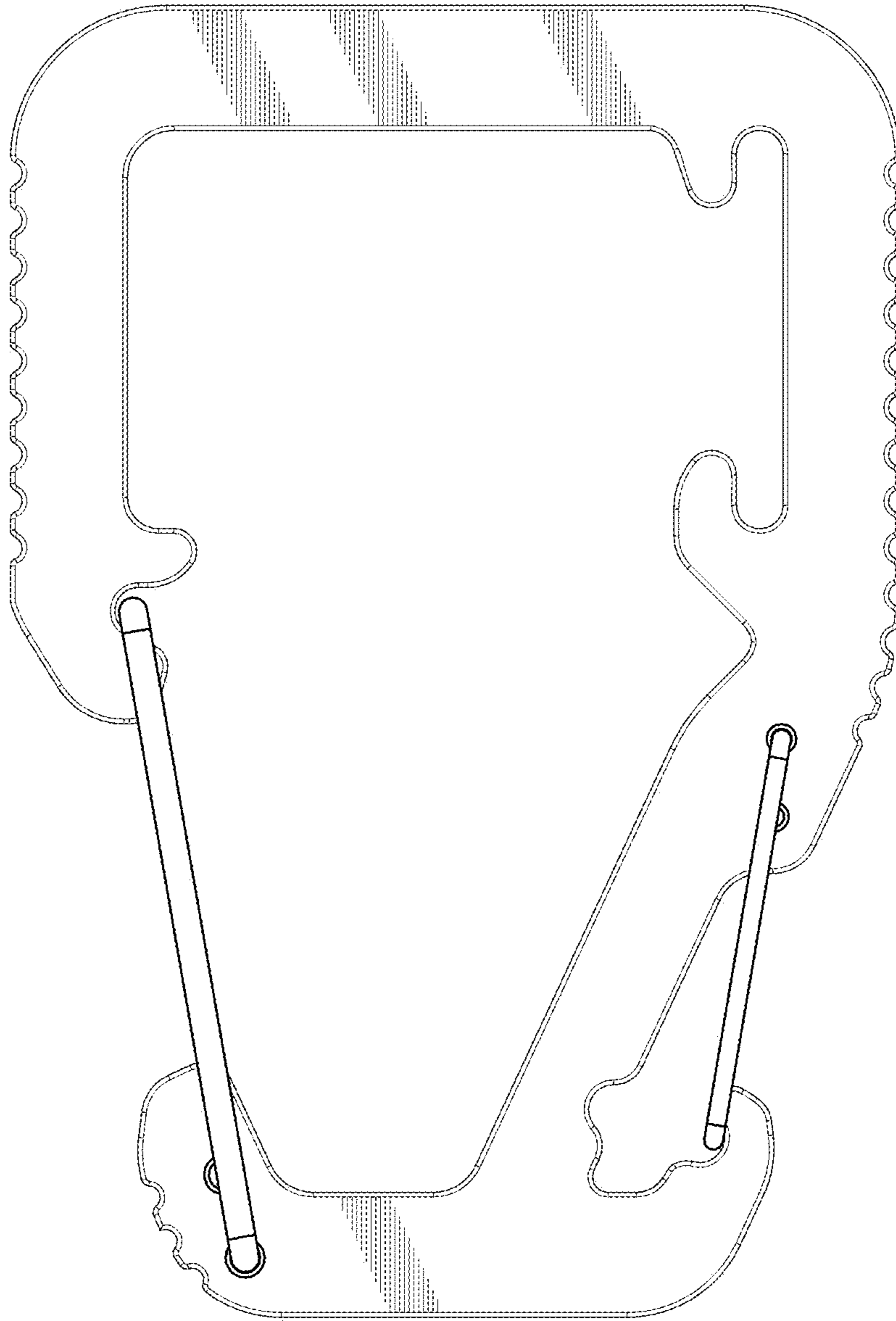
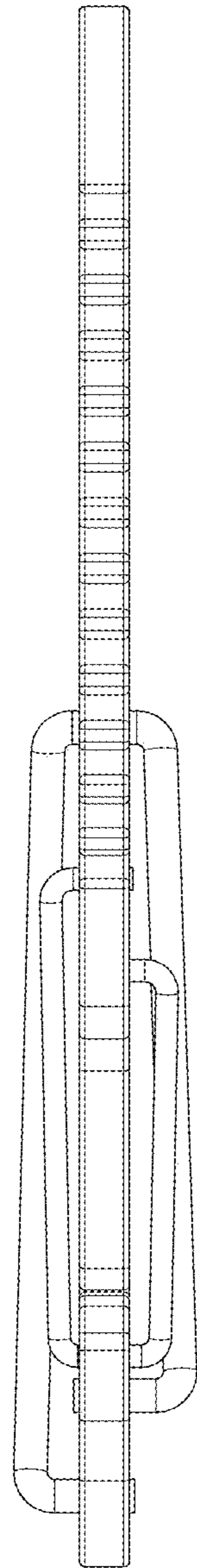
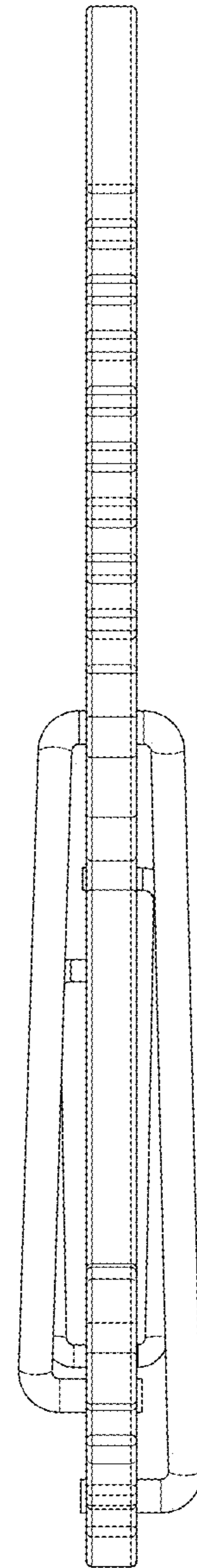

FIG. 3



*FIG. 4*



*FIG. 5*

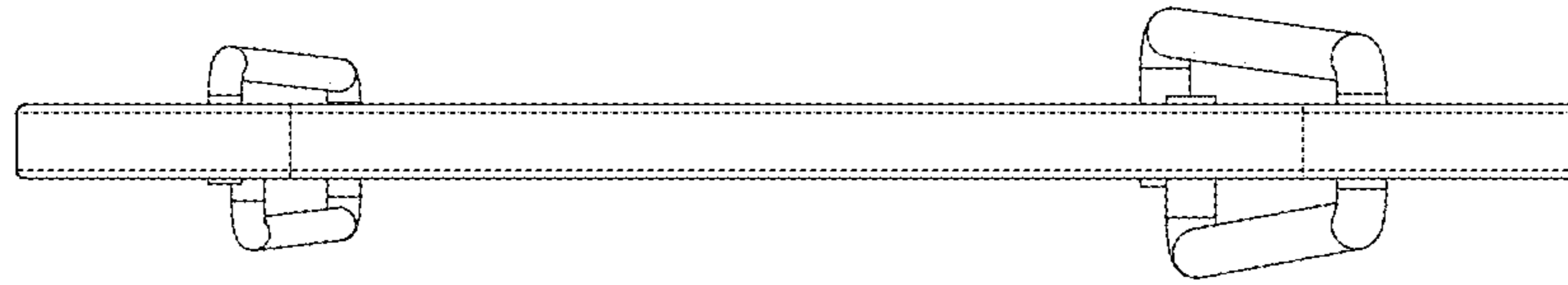

*FIG. 6*

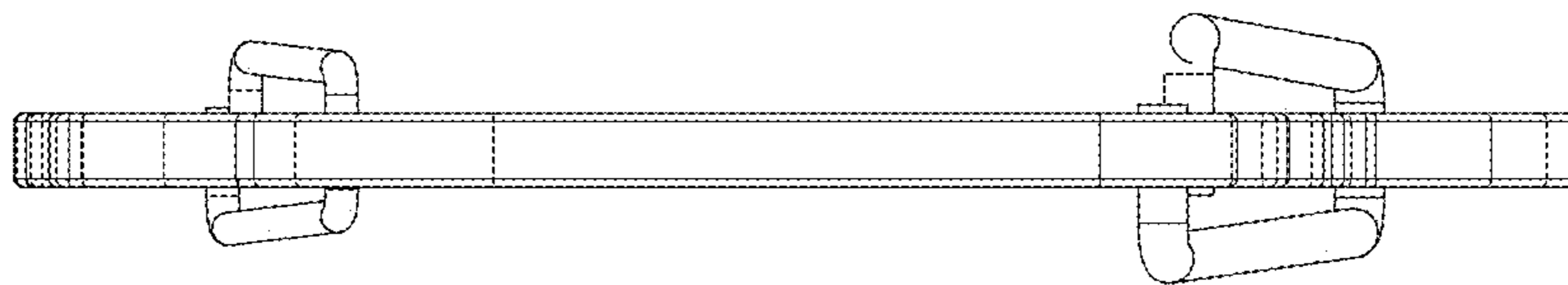

*FIG. 7*