



US00D947597S

(12) **United States Design Patent**
Shi

(10) **Patent No.:** **US D947,597 S**

(45) **Date of Patent:** **** Apr. 5, 2022**

(54) **WATER BOTTLE LID**

(71) Applicant: **Wenhui Shi**, Zhejiang (CN)

(72) Inventor: **Wenhui Shi**, Zhejiang (CN)

(73) Assignees: **Zhejiang Huannuo Industrial and Trading Co., Ltd.**, Zhejiang (CN);
Fujian SPD E-Commerce Co., Ltd., Fujian (CN)

(**) Term: **15 Years**

(21) Appl. No.: **29/732,969**

(22) Filed: **Apr. 29, 2020**

(51) **LOC (13) Cl.** **07-99**

(52) **U.S. Cl.**

USPC **D7/392.1**

(58) **Field of Classification Search**

USPC D6/515, 542; D7/391, 392, 392.1, 396.1, D7/396.2, 397, 398; D9/434, 435, 436, D9/439, 440, 447, 448, 449, 450, 452, D9/454, 682, 685, 686, 688, 690, 723, D9/729, 503, 504, 505, 516, 529, 548, D9/549

CPC B65D 47/065; B65D 47/066; B65D 1/46; B65D 41/00; B65D 41/38; B65D 41/56; B65D 41/63; B65D 47/00; B65D 47/06; B65D 47/08; B65D 2251/00; B65D 85/804; B65D 25/082; A47G 19/2205; A47G 19/2222; A45F 3/16; A45F 3/20; B67D 7/06; B67D 7/0004; A61J 1/00; A61J 1/1412; A47J 31/407

See application file for complete search history.

(56) **References Cited**

U.S. PATENT DOCUMENTS

D756,702 S * 5/2016 Joseph D7/392.1
D770,222 S * 11/2016 Boroski D7/392.1
D822,429 S * 7/2018 Washburn D7/396.2
D848,787 S * 5/2019 Tatsukawa D7/392.1
D853,181 S * 7/2019 Stanton D7/392
D870,509 S * 12/2019 Bo D7/392.1

D884,418 S * 5/2020 Wang D7/396.2
D886,517 S * 6/2020 Bo D7/392.1
D890,564 S * 7/2020 Hao D7/392.1
D896,024 S * 9/2020 Wang D7/392.1
D900,536 S * 11/2020 Yao D7/392.1
D902,648 S * 11/2020 Wang D7/392.1
D902,655 S * 11/2020 Wang D7/510
D905,498 S * 12/2020 Zhang D7/392.1

OTHER PUBLICATIONS

Healthy Human Flip N Sip: Announced Jan. 30, 2017 (online). Site visited [Mar. 23, 2021]. Available from Internet URL: https://www.amazon.com/Healthy-Human-FLIP-SIP-Stein/dp/B01ND1BG60/ref=sr_1_293?dchild=1&keywords=Sports+Bottle+Caps&qid=161655650%E2%80%A6.*

Life Factory: Announced May 6, 2020 (online). Site Visited [Mar. 23, 2021]. Available from Internet URL: https://www.amazon.com/Lifefactory-Accessory-12-Ounce-16-Ounce-22-Ounce/dp/B083TL3S7Z/ref=asc_df_B083TL3S7Z/?tag=hyprod-20&linkCode%E2%80%A6.*

Aquatix: Site Visited [Mar. 23, 2021]. Available from Internet URL: <https://www.walmart.com/ip/New-Redesigned-Aquatix-32-ounce-FlipTop-Bottle-Cap-with-Removable-ORANGE-Strap-Handle/960937849>.*

* cited by examiner

Primary Examiner — Catherine S Posthauer

(57) **CLAIM**

The ornamental design for a water bottle lid, as shown and described.

DESCRIPTION

FIG. 1 is a perspective view of a water bottle lid showing my new design;
FIG. 2 is a front elevation view thereof;
FIG. 3 is a rear elevation view thereof;
FIG. 4 is a left side elevation view thereof;
FIG. 5 is a right side elevation view thereof;
FIG. 6 is a top plan view thereof; and,
FIG. 7 is a bottom plan view thereof.

(Continued)

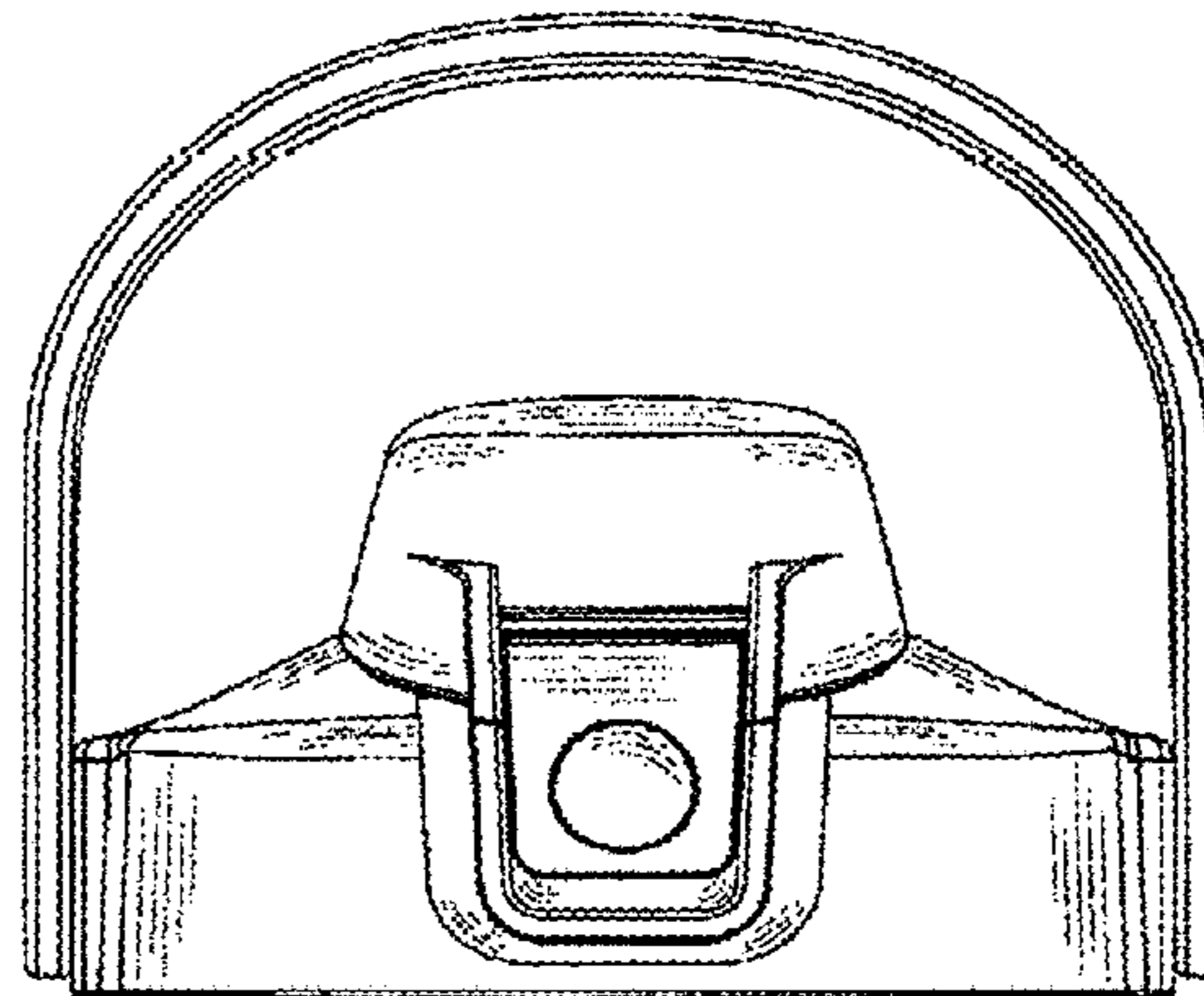
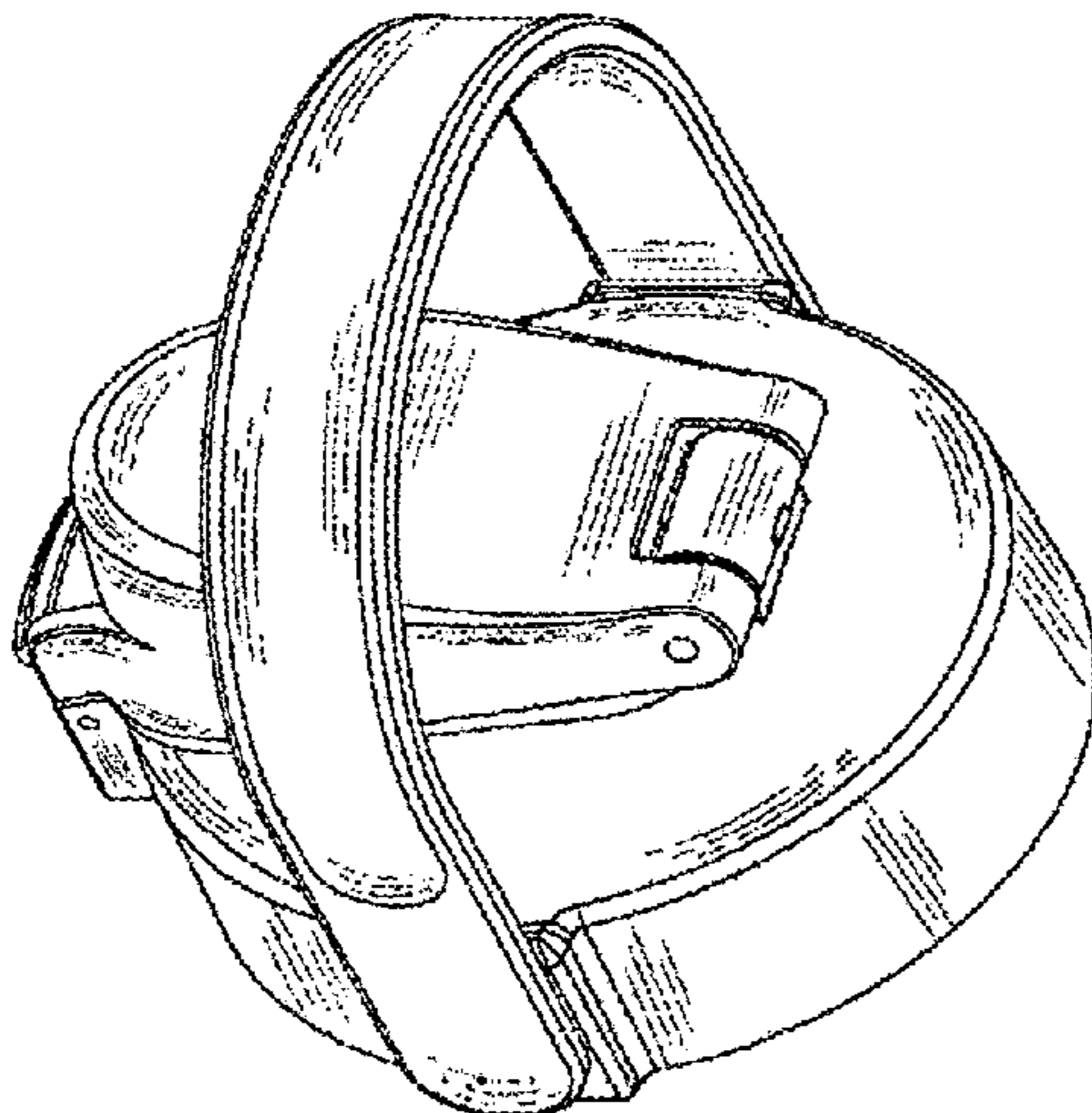

The broken lines are shown for the purpose of illustrating parts of the article that form no part of the claimed design.

1 Claim, 7 Drawing Sheets

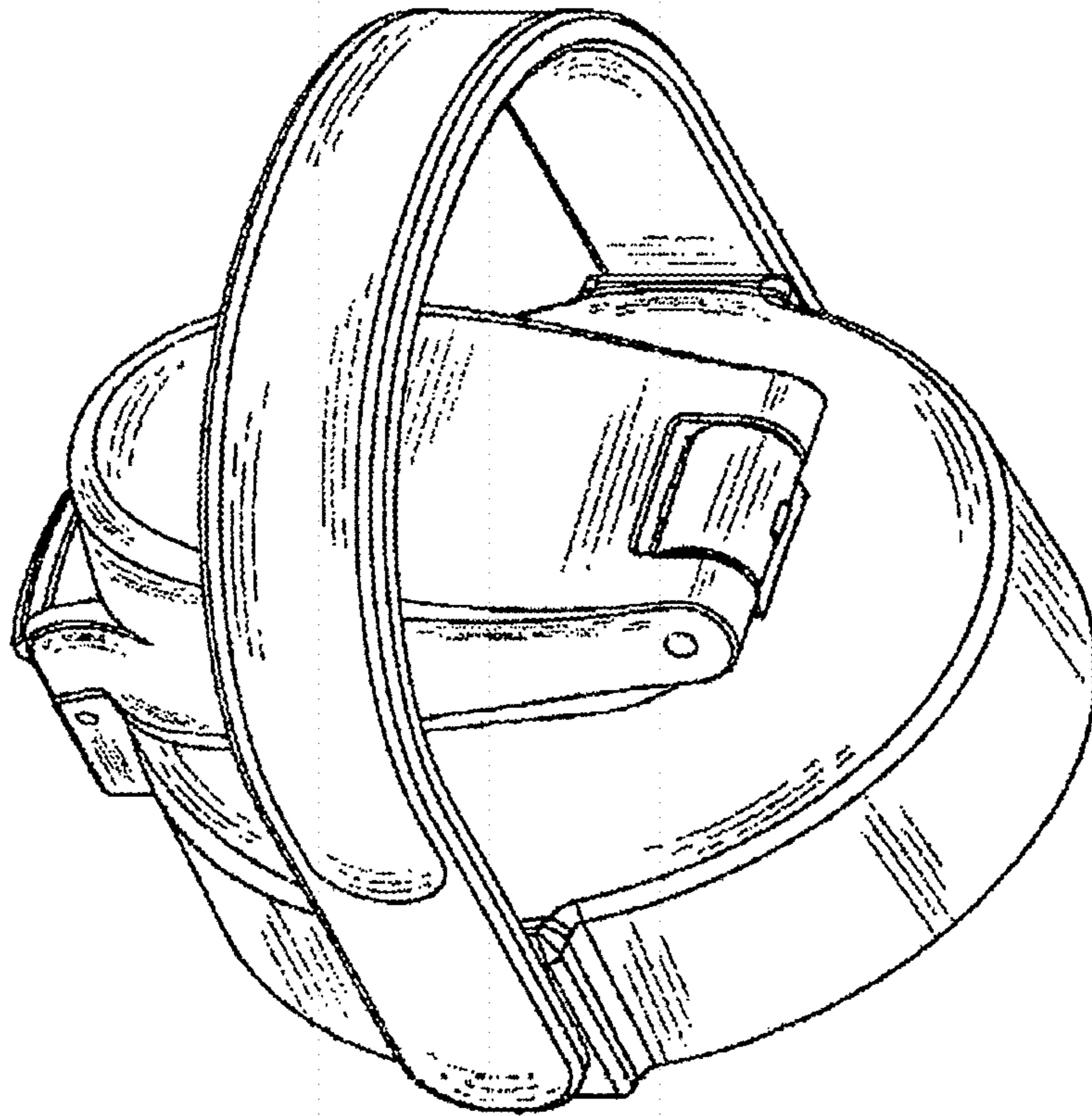

FIG.1

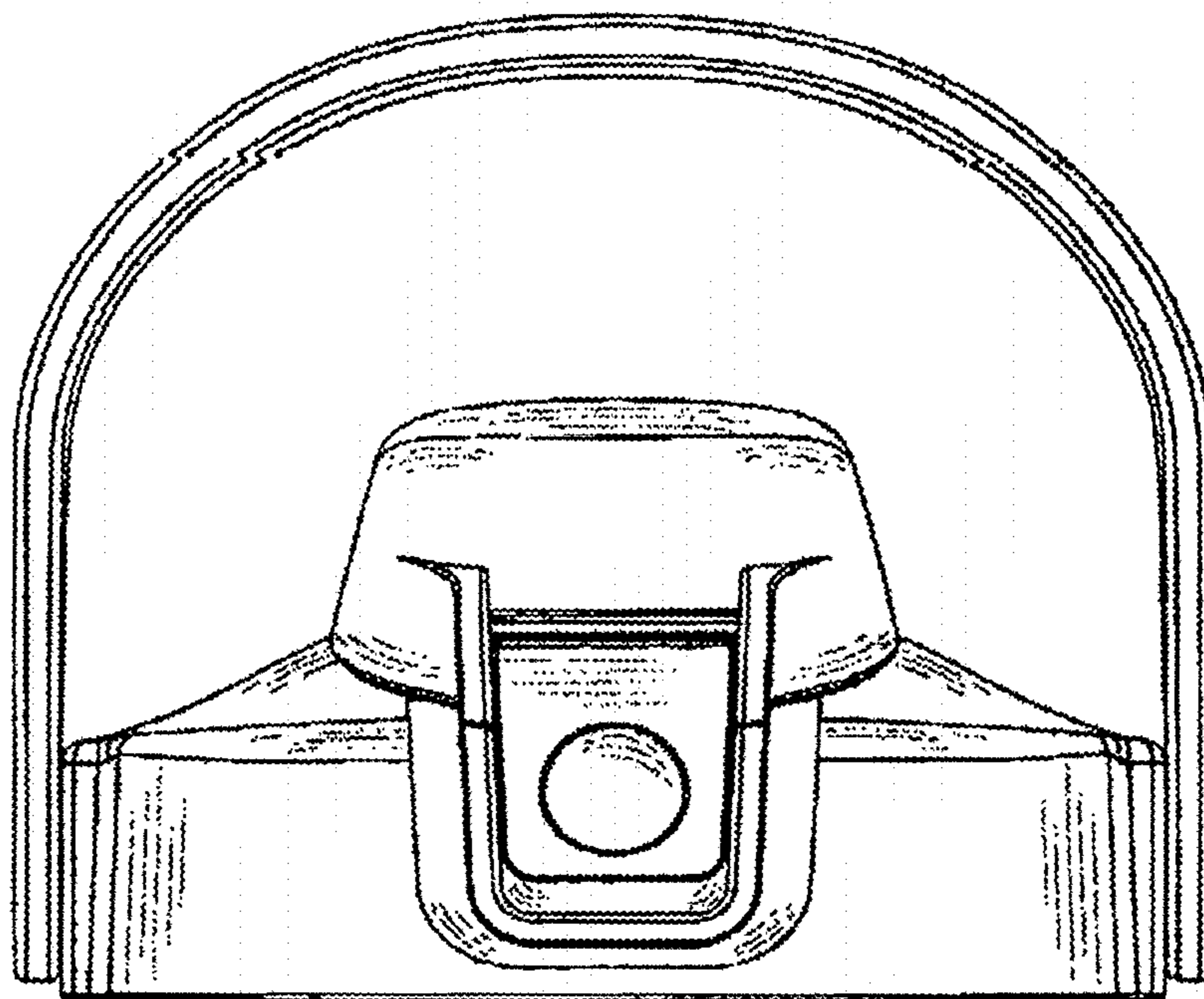

FIG. 2

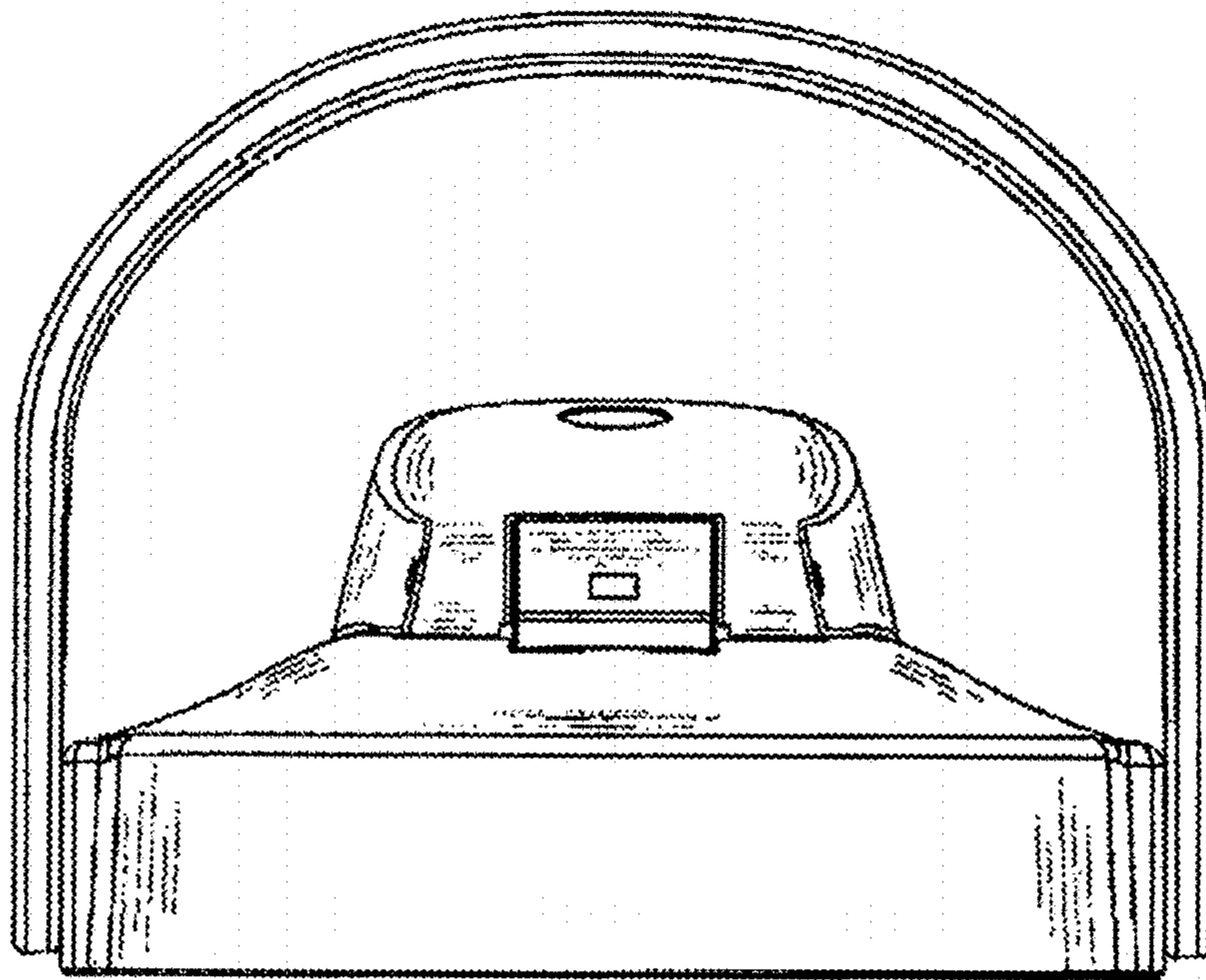

FIG.3

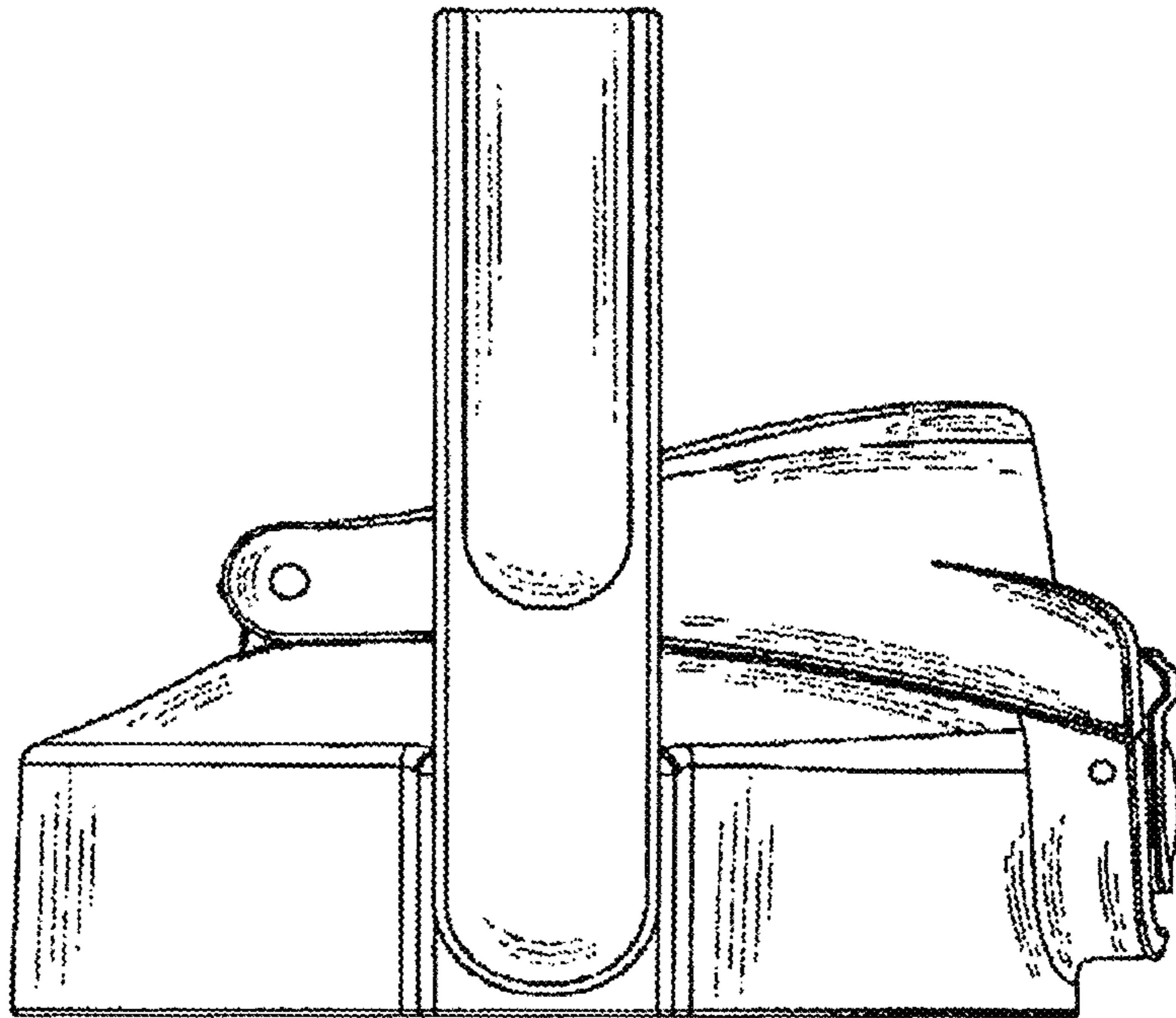

FIG.4

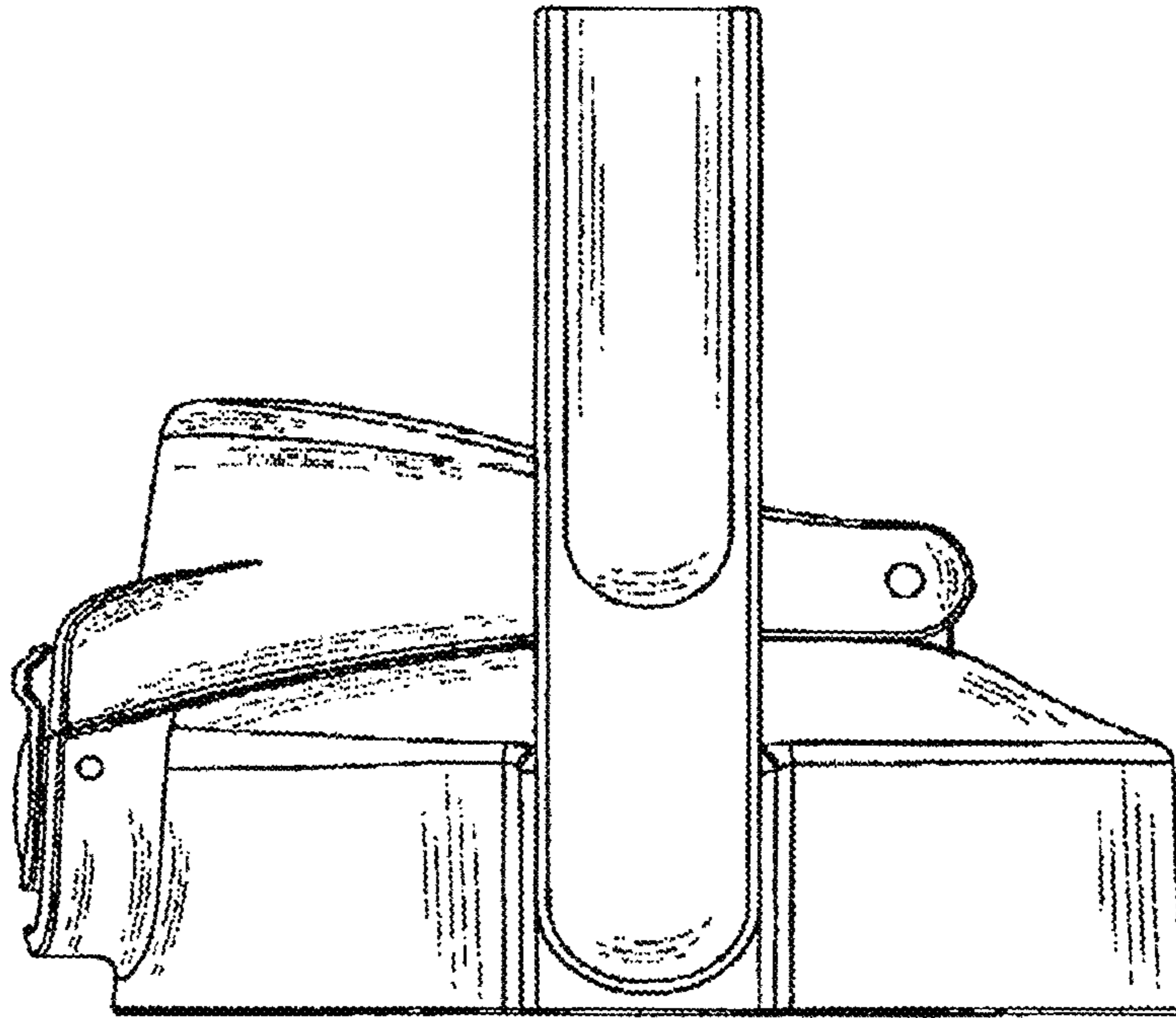

FIG.5

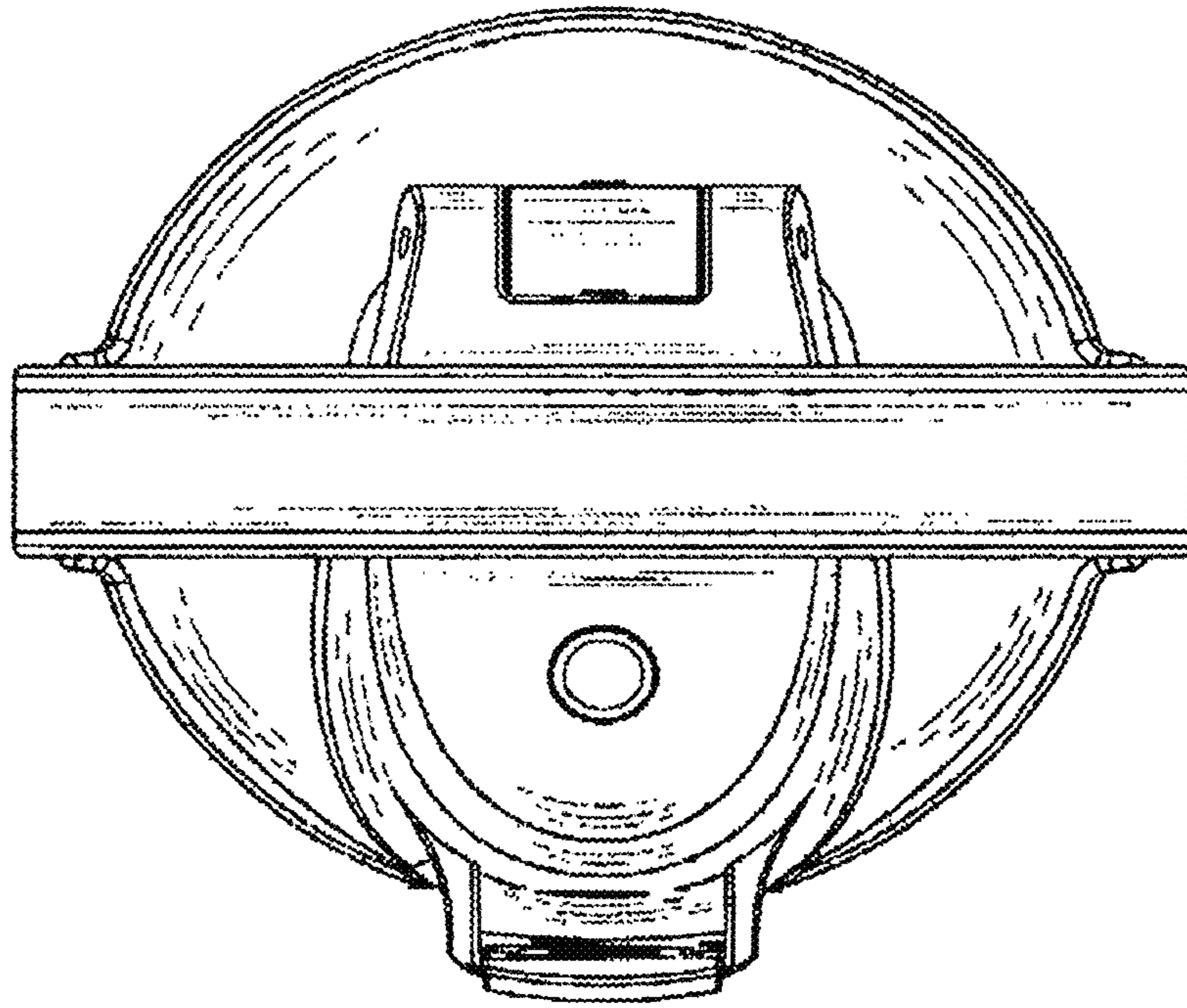

FIG.6

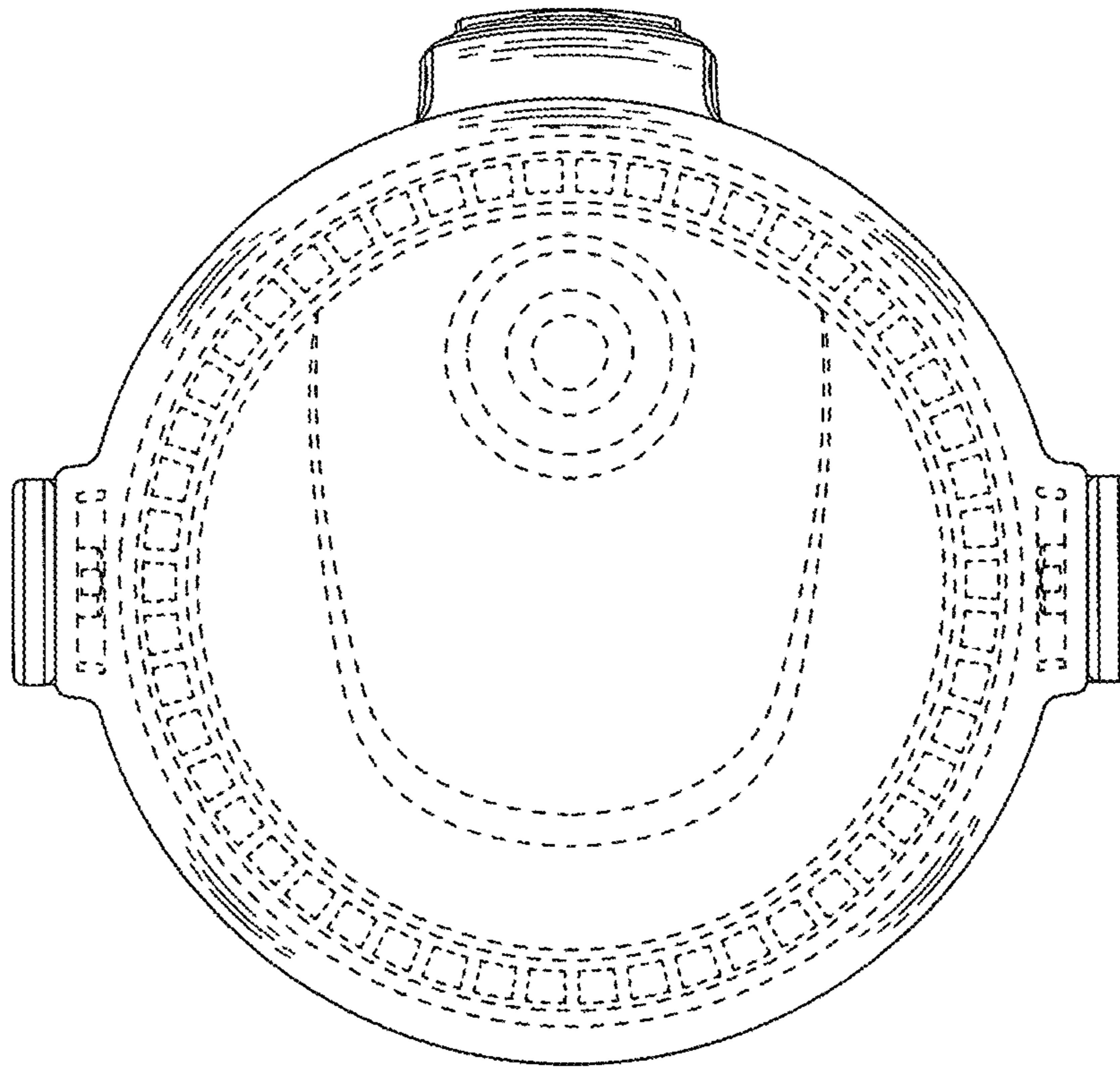

FIG. 7