

US00D947580S

(12) **United States Design Patent** (10) **Patent No.:** **US D947,580 S**  
**Packer et al.** (45) **Date of Patent:** **\*\* Apr. 5, 2022**

(54) **CONSOLE**

887,168 A 5/1908 Will  
1,097,697 A 5/1914 Weston  
D47,441 S 6/1915 Ullin

(71) Applicant: **WALKER EDISON FURNITURE COMPANY LLC**, Salt Lake City, UT (US)

(Continued)

**FOREIGN PATENT DOCUMENTS**

(72) Inventors: **Richard Packer**, Kaysville, UT (US);  
**Alexa Naylor**, South Jordan, UT (US)

CN 304163895 9/2017  
CN 304770575 8/2018

(73) Assignee: **Walker Edison Furniture Company LLC**, West Jordan, UT (US)

(Continued)

**OTHER PUBLICATIONS**

(\*\*) Term: **15 Years**

“Leather Belt Silver Square 2 Inch Buckle” Oct. 11, 2016, bucklemybelt.com, site visited Jan. 4, 2022 <<https://bucklemybelt.com/products/silver-square-2-inch-leather-belt>> (Year: 2016).\*

(21) Appl. No.: **29/815,516**

(22) Filed: **Nov. 15, 2021**

(Continued)

**Related U.S. Application Data**

*Primary Examiner* — Kevin K Rudzinski  
*Assistant Examiner* — Paul D Bohannon  
(74) *Attorney, Agent, or Firm* — Workman Nydegger

(62) Division of application No. 29/743,237, filed on Jul. 20, 2020.

(51) **LOC (13) Cl.** ..... **06-04**

(52) **U.S. Cl.**  
USPC ..... **D6/657**

(57) **CLAIM**

(58) **Field of Classification Search**  
USPC ..... D6/657, 664.1, 666, 668.2, 669, 671, D6/671.1, 675, 675.1, 675.3, 702, 663, D6/641, 703, 705, 705.5; D15/79, 81, D15/85, 88; D20/1, 4, 5; D23/286; D99/28  
CPC ..... A47F 9/00; A47B 43/00; A47B 87/002; E04H 1/00; E04H 1/1205; E04H 1/005; E04H 1/12; E04H 1/1283; D06F 57/10; E04B 1/34321; E04B 1/34331; E04B 1/3483; E04B 1/34807; E04B 1/343; E04B 1/348; E06B 1/04  
See application file for complete search history.

The ornamental design for a console, as shown and described.

**DESCRIPTION**

FIG. 1 is a front perspective view of a console showing the new design;  
FIG. 2 is a front elevation view thereof;  
FIG. 3 is a back elevation view thereof;  
FIG. 4 is a top plan view thereof;  
FIG. 5 is a bottom plan view thereof;  
FIG. 6 is a right elevation view thereof; and,  
FIG. 7 is a left elevation view thereof.  
The broken lines in the drawings are for the purpose of illustrating portions of the article that form no part of the claimed design.

(56) **References Cited**

**U.S. PATENT DOCUMENTS**

245,925 A 8/1881 Kinsley  
309,799 A 12/1884 Poulson

**1 Claim, 4 Drawing Sheets**

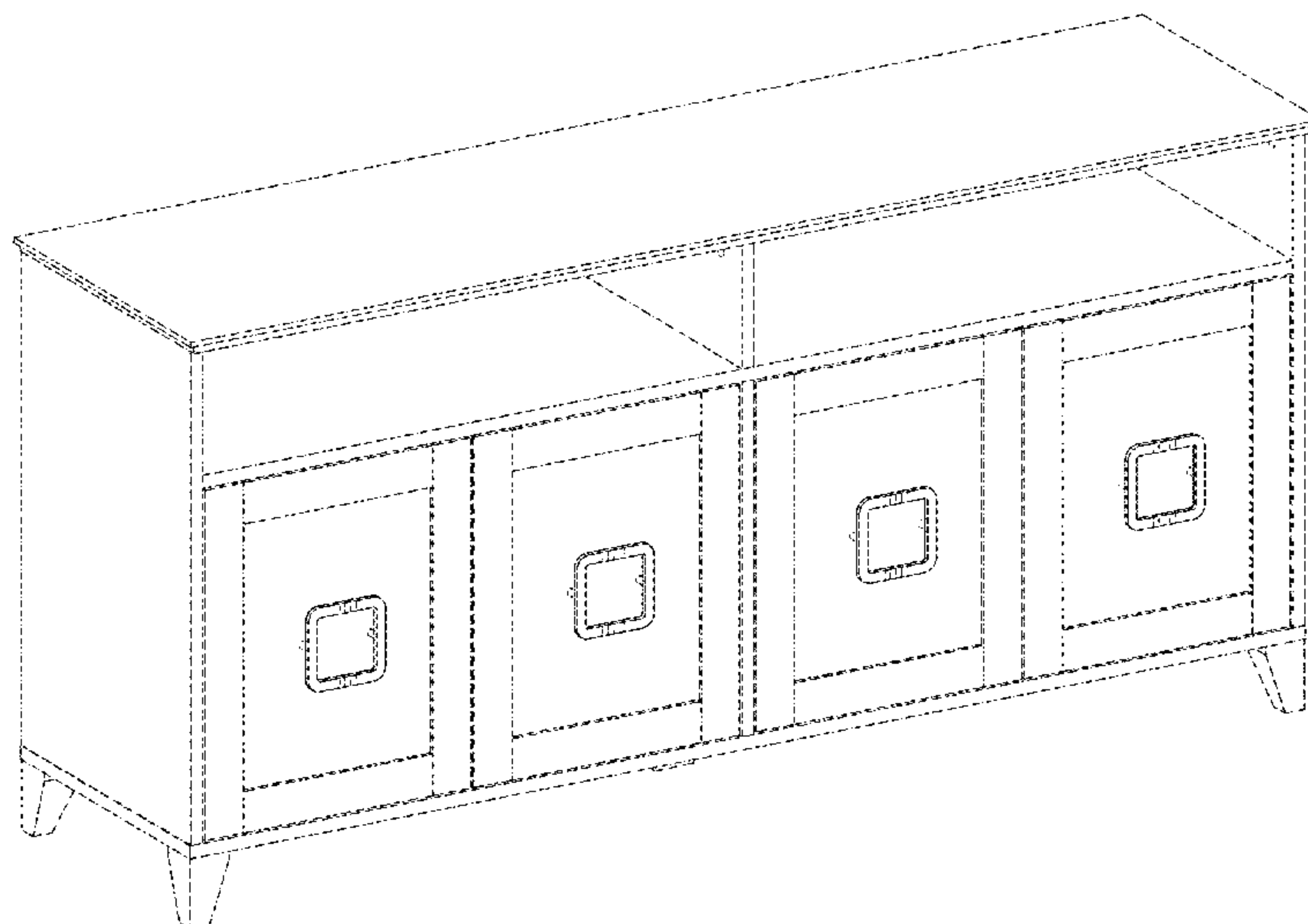

(56)

References Cited

U.S. PATENT DOCUMENTS

D47,600 S	7/1915	Koch		D273,829 S	5/1984	Desnoyers	
D61,344 S	8/1922	Mayer		D274,152 S	6/1984	Fleming	
1,475,088 A	11/1923	Specht et al.		D281,901 S	12/1985	Demrick	
D64,390 S	4/1924	Arons		D283,182 S	4/1986	Marshall	
D64,922 S	6/1924	Naill		D283,343 S	4/1986	Haythornthwaite	
D66,028 S	11/1924	Lyons et al.		D289,474 S	4/1987	Underwood	
D66,889 S	3/1925	Schleicher		D293,177 S	12/1987	Hamami	
1,538,393 A	5/1925	Martin		D293,521 S	1/1988	Handler	
D68,065 S	8/1925	Schleicher		4,793,667 A	12/1988	Gilliom	
D68,659 S	11/1925	Smith		D303,596 S	9/1989	Goetz	
D78,127 S	3/1929	Schleicher		D304,982 S	12/1989	Bush	
D103,250 S	2/1937	Parrish		D305,930 S	2/1990	MacAleese	
2,099,387 A *	11/1937	Samuelh .....	A44B 11/24	D306,106 S	2/1990	Bush	
			24/171	D319,230 S	8/1991	Sugiyama	
2,132,608 A *	10/1938	Eaton .....	A44B 11/24	5,036,778 A	8/1991	Brioso	
			24/178	D319,743 S	9/1991	Grey	
D120,370 S	5/1940	Bach		D321,571 S	11/1991	Lucariello	
2,207,307 A	7/1940	Teller		D322,184 S	12/1991	Prevedello	
D165,241 S	11/1951	Porter		D325,680 S	4/1992	Kiiski	
D166,077 S	3/1952	Haas		D327,735 S	7/1992	Smith	
2,696,419 A	12/1954	Wallance		D328,341 S	7/1992	Chiu	
D175,869 S	10/1955	Trout		D329,693 S	9/1992	Mills	
2,743,720 A	5/1956	Dollinger		D330,470 S	10/1992	Bennett	
D182,832 S	5/1958	Lubberts		D336,184 S	6/1993	Borgen	
D182,836 S	5/1958	Lubberts		D336,392 S	6/1993	Whalen	
2,836,871 A *	6/1958	Williams .....	A44B 11/06	D347,754 S	6/1994	Mehlin	
			24/170	D348,576 S	7/1994	Narramore	
2,850,346 A	9/1958	Holderle		D348,726 S	7/1994	Wilson	
D183,788 S *	10/1958	Carter et al. ....	D6/671.1	D353,960 S	1/1995	Barfield	
2,884,675 A *	5/1959	Sternschuss .....	A44B 11/22	5,409,122 A	4/1995	Lazarus	
			24/163 R	5,452,812 A	9/1995	Niequist	
D186,115 S	9/1959	Church		D363,176 S	10/1995	Berry	
2,918,176 A	12/1959	Bell		D363,841 S	11/1995	Nourse	
D187,232 S	2/1960	Matyas		D364,055 S	11/1995	Pakla	
D188,196 S	6/1960	Lubberts		D364,064 S	11/1995	Lorenz	
D188,197 S	6/1960	Swarts		5,463,966 A	11/1995	Nilsson	
3,039,621 A	6/1962	Pilcher		D365,472 S	12/1995	Rehnberg	
D193,516 S	9/1962	Deaton		D366,110 S	1/1996	Darr	
D195,726 S	7/1963	Harper		D367,383 S	2/1996	Hatrack-Smith	
D196,451 S	10/1963	McMullen		D373,693 S	9/1996	Elhage	
3,217,671 A	11/1965	Walsh		5,628,256 A	5/1997	Lazarus	
3,272,582 A	9/1966	Anderson/Mack		D384,227 S	9/1997	Grosfillex	
3,352,615 A	11/1967	Sandin		D385,431 S	10/1997	Lee	
3,354,878 A	11/1967	Balls		5,695,081 A	12/1997	Alkalay	
3,369,278 A *	2/1968	Humphreys .....	A44B 11/24	D389,343 S	1/1998	Van Der Merwe	
			24/163 R	D390,936 S	2/1998	French	
D220,704 S	5/1971	Kramer		5,752,500 A	5/1998	Jamieson	
3,589,746 A	6/1971	Inglis		5,765,265 A *	6/1998	Kang .....	A44B 11/24
RE27,186 E	10/1971	Ferdinand					24/177
RE27,200 E	10/1971	Unavailbale		5,782,231 A	7/1998	Wade	
3,688,707 A	9/1972	Maurice		D398,788 S	9/1998	Schubert	
3,762,789 A	10/1973	Robertson		5,833,084 A	11/1998	Chang	
3,766,863 A	10/1973	Swick		D403,529 S	1/1999	De Blaay	
D230,446 S	2/1974	Price		D404,937 S	2/1999	Tarlow	
D233,294 S	10/1974	Goulder		D407,577 S	4/1999	Dorst	
3,855,637 A *	12/1974	Luger .....	A44B 11/006	D408,174 S	4/1999	Aspenwall	
			2/301	D420,114 S	2/2000	Johnson	
D236,676 S	9/1975	Urti		D423,810 S	5/2000	Dorst	
D236,781 S	9/1975	Cowley		D423,813 S	5/2000	Paus	
D238,277 S	12/1975	Parker		D425,330 S	5/2000	O'Hare	
D239,352 S	3/1976	Petrick		6,074,029 A	6/2000	Snoke	
D240,381 S	7/1976	Tazaki		D428,609 S	7/2000	Williams	
D244,112 S	4/1977	Friedman		D430,431 S	9/2000	Walter	
D244,113 S	4/1977	Friedman		D438,727 S	3/2001	McDaniel	
D248,429 S	7/1978	Inohara		D440,079 S	4/2001	Wohlford	
D249,429 S	9/1978	Robinson		D446,047 S *	8/2001	Stone .....	D6/671
D249,860 S	10/1978	Ungaro		D448,203 S	9/2001	Jeup	
4,182,244 A	1/1980	Hutchins		D449,184 S	10/2001	Cain	
D259,316 S	5/1981	Offredi		D450,492 S	11/2001	Sabo	
D262,847 S	2/1982	Keller		D452,624 S	1/2002	de Blois	
D267,532 S	1/1983	Platner		D454,264 S	3/2002	Patik	
D269,754 S	7/1983	Kates		D454,732 S	3/2002	Frenkler	
D270,858 S	10/1983	McInnes		D455,916 S	4/2002	Fluhrer	
D271,259 S	11/1983	Smith		6,393,207 B1	5/2002	Martin	
				D462,008 S	8/2002	Stone	
				D466,333 S	12/2002	Hwang	
				6,515,262 B1	2/2003	Li	
				D473,404 S	4/2003	de Blois	
				D475,225 S	6/2003	McBrayer	



(56)

References Cited

U.S. PATENT DOCUMENTS

D477,160 S	7/2003	Grosfillex	D611,727 S	3/2010	Vail
D478,432 S	8/2003	Juneau	D614,888 S	5/2010	Sexton
D479,925 S	9/2003	Hsieh	D618,015 S	6/2010	Sexton
D485,450 S	1/2004	Smith	D618,016 S	6/2010	Metcalf
D485,709 S	1/2004	de Blois	D620,278 S	7/2010	Zambelli
D486,015 S	2/2004	de Blois	D620,283 S	7/2010	Calco
D492,989 S	7/2004	Beck	D622,834 S	8/2010	Jiang
D495,527 S	9/2004	Walker	D623,442 S	9/2010	Zambelli
D495,898 S	9/2004	Walker	D623,876 S	9/2010	Zambelli
6,789,859 B1	9/2004	Ho	D623,877 S	9/2010	Zambelli
D497,741 S	11/2004	Sexton	D625,123 S	9/2010	Zambelli
D499,274 S	12/2004	Juneau	D630,453 S	1/2011	Rafieha
D499,281 S	12/2004	Yamaguchi	D632,902 S	2/2011	Rafieha
D499,583 S	12/2004	Anderson	D638,922 S	5/2011	Zhou
D500,929 S	1/2005	Walker	7,934,494 B1	5/2011	Schneider
D502,617 S	3/2005	Chang	D640,072 S	6/2011	Sexton
D503,570 S	4/2005	Anderson	D641,861 S	7/2011	Okamoto
D507,428 S	7/2005	Weatherly	D644,853 S	9/2011	Becker
D507,899 S	8/2005	Rozenboom	D648,152 S	11/2011	Walker
D510,211 S	10/2005	Welborn, Jr.	D652,232 S	1/2012	Walker
D518,978 S	4/2006	Katz	D653,051 S	1/2012	Lin
D519,203 S	4/2006	Haas	D653,739 S	2/2012	Gibbs
D519,299 S	4/2006	Boudreau	D654,289 S	2/2012	Zambelli
D520,779 S	5/2006	DeBlois	D654,995 S	2/2012	Asofsky
D522,771 S	6/2006	Berry	D654,996 S	2/2012	Asofsky
D522,773 S	6/2006	Becker	D655,946 S	3/2012	Sexton
D526,143 S	8/2006	Bruce	D658,750 S	5/2012	Nemes
D528,327 S	9/2006	O'Reilly	D663,137 S	7/2012	Andersen
D531,835 S	11/2006	Harwanko	D663,138 S	7/2012	Andersen
D534,379 S	1/2007	Juneau	D665,897 S	8/2012	Martin
D534,998 S	1/2007	Charnick	D666,281 S	8/2012	Nemes
D536,770 S	2/2007	Mayer	D667,653 S	9/2012	Lenney
D538,406 S	3/2007	Mayer	D667,654 S	9/2012	Lenney
D539,057 S	3/2007	Senda	D668,475 S	10/2012	Zambelli
D542,059 S	5/2007	Moyle	D669,704 S	10/2012	Zambelli
D543,057 S	5/2007	Grady	D669,706 S	10/2012	Zambelli
D543,488 S *	5/2007	Tobergte ..... D11/234	D669,707 S	10/2012	Zambelli
D543,728 S	6/2007	Becker	D670,105 S	11/2012	Jespersen
D548,488 S	8/2007	Weatherly	D671,769 S	12/2012	Olson
D548,490 S	8/2007	Becker	D674,891 S *	1/2013	Huang ..... D23/404
D549,991 S	9/2007	Stravitz	D675,716 S	2/2013	Schwartz
D553,879 S	10/2007	Juneau	D677,074 S	3/2013	Olson
D554,393 S	11/2007	Yalif	D687,250 S	8/2013	Weatherly
D554,897 S	11/2007	Mayer	D694,873 S	12/2013	Nemes
D555,397 S	11/2007	Yalif	D696,758 S	12/2013	Ernst
D559,017 S	1/2008	Mack	8,607,776 B2	12/2013	Jansson
D559,583 S	1/2008	Zambelli	8,813,656 B1	8/2014	Hazzard
D559,584 S	1/2008	Zambelli	D716,288 S	10/2014	O'Heron
D559,585 S	1/2008	Lara	D717,081 S	11/2014	Dworman
D560,077 S	1/2008	Zambelli	D717,569 S	11/2014	Davis
D560,396 S	1/2008	Weatherly	D718,956 S	12/2014	Heiser
D560,403 S	1/2008	Mack	D718,957 S	12/2014	Heiser
D560,930 S	2/2008	Woodward	D719,384 S	12/2014	Sowers
D561,317 S	2/2008	Ou	D720,563 S	1/2015	Burden
D562,597 S	2/2008	Weatherly	D722,458 S	2/2015	Chen
D564,789 S	3/2008	deCarolis	D723,148 S	2/2015	Lawrence
D567,346 S	4/2008	Lin	D723,843 S	3/2015	Lai
D586,585 S	2/2009	Hynes	9,004,060 B2	4/2015	Benedetti
D587,483 S	3/2009	Zambelli	D728,975 S	5/2015	Park
D587,484 S	3/2009	Mack	D730,089 S	5/2015	Carbone
D587,497 S	3/2009	Zambelli	D731,823 S	6/2015	Kelinske
D588,831 S	3/2009	Mohundro	D736,012 S	8/2015	Davis
D589,280 S	3/2009	Zambelli	D737,418 S	8/2015	Hrydovyy
D591,533 S	5/2009	Karsson	D738,477 S	9/2015	Nemes
D592,432 S	5/2009	Sexton	D738,647 S	9/2015	Muller
7,530,538 B2	5/2009	Whalen	D741,090 S	10/2015	Ward
D593,776 S	6/2009	Sexton	D741,630 S	10/2015	Meissner
D594,248 S	6/2009	Zambelli	D742,142 S	11/2015	Everson
D595,979 S	7/2009	Schweikarth	D742,662 S	11/2015	Muller
D598,672 S	8/2009	Maly	D743,192 S	11/2015	Davis
D604,546 S	11/2009	Alman	D746,614 S	1/2016	Sheppard
D605,874 S	12/2009	Zambelli	D747,123 S	1/2016	Zambelli
D606,331 S	12/2009	Wicha	D747,788 S	1/2016	Baker
D609,497 S	2/2010	Kanthasamy	D747,900 S	1/2016	Sheppard
D609,503 S	2/2010	Hayes	9,228,742 B2	1/2016	Akiyama
			D748,768 S	2/2016	Stanton
			D752,905 S	4/2016	Healy
			D753,930 S	4/2016	Vengadakrishnan
			D757,350 S	5/2016	Levy



(56)

References Cited

U.S. PATENT DOCUMENTS

D758,766 S 6/2016 Kirar  
 D759,997 S 6/2016 Ruiz  
 D767,752 S 6/2016 Davis  
 D767,753 S 9/2016 Edmund  
 D767,921 S 10/2016 Burden  
 D768,413 S 10/2016 Huang  
 D773,862 S 12/2016 Davis  
 D775,866 S 1/2017 Ben Avi  
 D777,479 S 1/2017 Anderson  
 D778,641 S 2/2017 Anderson  
 D778,646 S 2/2017 Davis  
 D783,324 S 4/2017 Akana  
 D791,302 S 7/2017 Davis  
 D791,522 S 7/2017 Rafieha  
 D792,132 S 7/2017 Peota  
 D793,776 S 8/2017 Davis  
 D798,640 S 10/2017 Anderson  
 D804,861 S 12/2017 Failing  
 D807,671 S 1/2018 Caillouet  
 D808,203 S 1/2018 Davis  
 D808,688 S 1/2018 Everson  
 D808,690 S 1/2018 Hsu  
 D812,938 S 3/2018 Moore  
 D814,410 S 4/2018 Emslie  
 D815,465 S 4/2018 Hannoosh  
 D817,037 S 5/2018 Davis  
 D817,038 S 5/2018 Davis  
 D817,040 S 5/2018 Davis  
 D817,666 S 5/2018 Davis  
 D817,667 S 5/2018 Davis  
 D818,750 S 5/2018 Hannoosh  
 D821,038 S 6/2018 Rathman  
 D824,703 S 8/2018 Yamamoto  
 D825,233 S 8/2018 Yamamoto  
 D825,959 S 8/2018 Rockwell  
 D833,782 S 11/2018 Amacher  
 D834,354 S 11/2018 Davis  
 D834,355 S 11/2018 Davis  
 D835,437 S 12/2018 Stukenberg  
 D835,925 S 12/2018 Denby  
 D838,523 S 1/2019 Yamamoto  
 D843,756 S 3/2019 Johnson  
 D845,041 S 4/2019 Davis  
 D845,679 S 4/2019 Li  
 D845,683 S 4/2019 Pedersen  
 D848,766 S 5/2019 Chen  
 D848,767 S 5/2019 Smrstick  
 D848,768 S 5/2019 Johnson  
 D848,770 S 5/2019 Davis  
 D849,457 S 5/2019 Kundig  
 D850,815 S 6/2019 Nicoll  
 D851,426 S 6/2019 Saotome  
 D852,429 S 6/2019 Rathman  
 D853,052 S 7/2019 Rathman  
 D858,148 S 9/2019 Crutcher  
 D859,038 S 9/2019 Davis  
 D860,687 S 9/2019 Parikh  
 D861,388 S 10/2019 Bray  
 D862,940 S 10/2019 Bray  
 D866,225 S 11/2019 Gelman  
 D867,032 S 11/2019 Bellini  
 10,473,335 B2 11/2019 Nemes  
 D869,201 S 12/2019 Davis  
 D869,202 S 12/2019 Davis  
 D870,492 S 12/2019 Young  
 D870,493 S 12/2019 Young  
 D874,192 S 2/2020 Velez  
 D878,116 S 3/2020 Davis  
 D878,816 S 3/2020 Davis  
 D878,817 S 3/2020 Davis  
 D878,823 S 3/2020 Davis  
 D879,516 S 3/2020 Davis  
 D882,989 S 5/2020 Davis  
 D885,091 S 5/2020 Davis  
 D886,499 S 6/2020 Davis

D888,467 S 6/2020 Li  
 D891,831 S 8/2020 Davis  
 D894,641 S 9/2020 Davis  
 D900,510 S 11/2020 Davis  
 D904,082 S 12/2020 Davis  
 D904,801 S 12/2020 Davis  
 D904,802 S 12/2020 Davis  
 D904,803 S 12/2020 Davis  
 D904,804 S 12/2020 Davis  
 D906,020 S 12/2020 Davis  
 D906,021 S 12/2020 Davis  
 D908,404 S 1/2021 Davis  
 D908,405 S 1/2021 Davis  
 D909,797 S 2/2021 Davis  
 D914,400 S 3/2021 Davis  
 D922,798 S 6/2021 Packer  
 D922,799 S 6/2021 Davis  
 D926,500 S 8/2021 Davis  
 D927,898 S 8/2021 Davis  
 D931,662 S 9/2021 Davis  
 2004/0074858 A1 4/2004 Thuma  
 2004/0079714 A1 4/2004 Andrew  
 2004/0160087 A1\* 8/2004 Tiesler ..... B60R 7/04  
 296/193.04  
 2004/0222721 A1 11/2004 Kelley  
 2004/0237853 A1 12/2004 Sholz  
 2005/0000241 A1 1/2005 Kucera  
 2005/0103734 A1 5/2005 Saltzberg  
 2007/0062983 A1 3/2007 Barnett  
 2007/0138119 A1 6/2007 Schwerdlin  
 2007/0236111 A1 10/2007 Gray  
 2007/0236113 A1 10/2007 McCambridge  
 2008/0116771 A1 5/2008 Green  
 2008/0181587 A1 7/2008 Patil  
 2008/0203042 A1 8/2008 Felsenthal  
 2008/0216817 A1 9/2008 Yungbluth  
 2009/0025414 A1 1/2009 Koga  
 2009/0151375 A1 6/2009 Tarr  
 2009/0170421 A1 7/2009 Adrian  
 2009/0220221 A1 9/2009 Zhou  
 2010/0307179 A1 12/2010 Fava  
 2011/0000477 A1 1/2011 Kwon  
 2011/0012481 A1 1/2011 Becker  
 2011/0017691 A1 1/2011 Wu  
 2011/0079688 A1 4/2011 Grove  
 2011/0080261 A1 4/2011 Asofsky  
 2011/0120166 A1 5/2011 Nadel  
 2011/0220090 A1 9/2011 Atemboski  
 2013/0052388 A1 2/2013 Burrows  
 2014/0116418 A1 5/2014 Thomas  
 2014/0239136 A1 8/2014 Ortega  
 2014/0252939 A1 9/2014 Tunzi  
 2014/0265754 A1 9/2014 Patterson  
 2014/0265807 A1 9/2014 Kendall  
 2014/0318529 A1 10/2014 Nielsen  
 2015/0027349 A1 1/2015 Kahle  
 2015/0182021 A1 7/2015 Chang  
 2015/0323190 A1 11/2015 Stein  
 2016/0018112 A1 1/2016 Phillips  
 2016/0100698 A1 4/2016 Clark  
 2016/0157605 A1 6/2016 Grad  
 2016/0195277 A1 7/2016 Li  
 2016/0209102 A1 7/2016 Vulava  
 2016/0223213 A1 8/2016 Grehova  
 2016/0256032 A1 9/2016 Bhajak  
 2017/0089587 A1 3/2017 Nemes  
 2017/0211814 A1 7/2017 Bourne  
 2018/0029270 A1\* 2/2018 Hepler ..... B29C 45/278  
 2018/0053974 A1\* 2/2018 Lee ..... H01M 50/147  
 2018/0064246 A1 3/2018 Kassanoff  
 2021/0088221 A1 3/2021 Crowe

FOREIGN PATENT DOCUMENTS

CN 305138614 5/2019  
 EM 003068485-0003 4/2016  
 EM 003254200-0003 6/2016  
 EM 005646783-0006 9/2018  
 GB 1162368 8/1969



(56)

## References Cited

## FOREIGN PATENT DOCUMENTS

GB	4001474	5/2007
GB	4032905	11/2013
GB	4034171	7/2014
GB	6041896	8/2018
WO	WOD076242-061	5/2011

## OTHER PUBLICATIONS

“Superstrut 5-Count 3/4-in Galvanized/Coated Square Washer” Jul. 6, 2018, lowes.com, site visited Jan. 4, 2022 <<https://www.lowes.com/pd/Superstrut-5-Count-3-4-in-Galvanized-Coated-Square-Washers/3284472>> (Year: 2018).\*

“2” Wide Brass Leather Belt . . . ” Mar. 6, 2019, etsy.com, site visited Jan. 4, 2022 <[https://www.etsy.com/listing/548206878/2-wide-brass-leather-belt-2-inch-belt?click\\_key=e4f72ca8f0645d9ccb32a01b02514d7ff873a3aa%3A548206878&click\\_sum=d7a93e5e&rec\\_type=ss&ref=landingpage\\_similar\\_listing\\_top-1&frs=1](https://www.etsy.com/listing/548206878/2-wide-brass-leather-belt-2-inch-belt?click_key=e4f72ca8f0645d9ccb32a01b02514d7ff873a3aa%3A548206878&click_sum=d7a93e5e&rec_type=ss&ref=landingpage_similar_listing_top-1&frs=1)> (Year: 2019).\*

U.S. Appl. No. 29/611,963, filed Jul. 27, 2017, Davis.  
 U.S. Appl. No. 29/634,946, filed Jan. 25, 2018, Davis.  
 U.S. Appl. No. 29/654,950, filed Jun. 28, 2018, Davis.  
 U.S. Appl. No. 29/720,093, filed Jan. 9, 2020, Davis.  
 U.S. Appl. No. 29/656,499, filed Jul. 12, 2018, Davis.  
 U.S. Appl. No. 29/656,479, filed Jul. 12, 2018, Davis.  
 U.S. Appl. No. 29/656,485, filed Jul. 12, 2018, Davis.  
 U.S. Appl. No. 29/656,486, filed Jul. 12, 2018, Davis.  
 U.S. Appl. No. 29/656,497, filed Jul. 12, 2018, Davis.  
 U.S. Appl. No. 29/654,930, filed Jun. 28, 2018, Davis.  
 U.S. Appl. No. 29/654,936, filed Jun. 28, 2018, Davis.  
 U.S. Appl. No. 29/654,952, filed Jun. 28, 2018, Davis.  
 U.S. Appl. No. 29/656,492, filed Jul. 12, 2018, Davis.  
 U.S. Appl. No. 29/656,489, filed Jul. 12, 2018, Davis.  
 U.S. Appl. No. 29/634,889, filed Jan. 25, 2018, Davis.  
 U.S. Appl. No. 29/677,722, filed Jan. 23, 2019, Davis.  
 U.S. Appl. No. 29/677,723, filed Jan. 23, 2019, Davis.  
 U.S. Appl. No. 29/677,724, filed Jan. 23, 2019, Davis.  
 U.S. Appl. No. 29/677,738, filed Jan. 23, 2019, Davis.  
 U.S. Appl. No. 29/677,755, filed Jan. 23, 2019, Davis.  
 U.S. Appl. No. 29/677,761, filed Jan. 23, 2019, Davis.  
 U.S. Appl. No. 29/698,919, filed Jul. 22, 2019, Davis.  
 U.S. Appl. No. 29/773,569, filed Mar. 10, 2021, Davis.  
 U.S. Appl. No. 29/756,291, filed Oct. 27, 2020, Davis.  
 U.S. Appl. No. 29/756,302, filed Oct. 27, 2020, Davis.  
 U.S. Appl. No. 29/756,303, filed Oct. 27, 2020, Davis.  
 U.S. Appl. No. 29/756,305, filed Oct. 27, 2020, Davis.  
 U.S. Appl. No. 29/698,924, filed Jul. 22, 2019, Davis.  
 U.S. Appl. No. 29/698,928, filed Jul. 22, 2019, Davis.  
 U.S. Appl. No. 29/698,940, filed Jul. 22, 2019, Davis.  
 U.S. Appl. No. 29/756,763, filed Oct. 30, 2020, Davis.  
 U.S. Appl. No. 29/699,063, filed Jul. 23, 2019, Davis.  
 U.S. Appl. No. 29/699,066, filed Jul. 23, 2019, Davis.  
 U.S. Appl. No. 29/714,849, filed Nov. 26, 2019, Davis.  
 U.S. Appl. No. 29/699,071, filed Jul. 23, 2019, Davis.  
 U.S. Appl. No. 29/699,073, filed Jul. 23, 2019, Davis.  
 U.S. Appl. No. 29/699,078, filed Jul. 23, 2019, Davis.  
 U.S. Appl. No. 29/698,942, filed Jul. 22, 2019, Davis.  
 U.S. Appl. No. 29/698,947, filed Jul. 22, 2019, Davis.  
 U.S. Appl. No. 29/720,729, filed Jan. 15, 2020, Davis.  
 U.S. Appl. No. 29/720,732, filed Jan. 15, 2020, Davis.  
 U.S. Appl. No. 29/721,435, filed Jan. 21, 2020, Davis.  
 U.S. Appl. No. 29/720,734, filed Jan. 15, 2020, Davis.  
 U.S. Appl. No. 29/720,923, filed Jan. 16, 2020, Davis.  
 U.S. Appl. No. 29/720,927, filed Jan. 16, 2020, Davis.  
 U.S. Appl. No. 29/720,942, filed Jan. 16, 2020, Davis.  
 U.S. Appl. No. 29/720,948, filed Jan. 16, 2020, Davis.  
 U.S. Appl. No. 29/721,166, filed Jan. 17, 2020, Davis.  
 U.S. Appl. No. 29/743,237, filed Jul. 20, 2020, Packer.  
 U.S. Appl. No. 29/743,240, filed Jul. 20, 2020, Packer.

U.S. Appl. No. 29/743,244, filed Jul. 20, 2020, Packer.  
 U.S. Appl. No. 29/743,246, filed Jul. 20, 2020, Packer.  
 U.S. Appl. No. 29/743,247, filed Jul. 20, 2020, Packer.  
 U.S. Appl. No. 29/743,250, filed Jul. 20, 2020, Packer.  
 U.S. Appl. No. 29/743,416, filed Jul. 21, 2020, Packer.  
 U.S. Appl. No. 29/743,418, filed Jul. 21, 2020, Packer.  
 U.S. Appl. No. 29/743,423, filed Jul. 21, 2020, Packer.  
 U.S. Appl. No. 29/743,584, filed Jul. 22, 2020, Packer.  
 U.S. Appl. No. 29/728,971, filed Mar. 23, 2020, Davis.  
 U.S. Appl. No. 29/767,917, filed Jan. 26, 2021, Duhadway.  
 U.S. Appl. No. 29/767,919, filed Jan. 26, 2021, Naylor.  
 U.S. Appl. No. 29/768,116, filed Jan. 27, 2021, Naylor.  
 U.S. Appl. No. 29/785,130, filed May 24, 2021, Duhadway.  
 U.S. Appl. No. 29/785,154, filed May 24, 2021, Duhadway.  
 U.S. Appl. No. 29/794,351, filed Jun. 11, 2021, Naylor.  
 U.S. Appl. No. 29/796,878, filed Jun. 28, 2021, Duhadway.  
 U.S. Appl. No. 29/794,592, filed Jun. 14, 2021, Naylor.  
 U.S. Appl. No. 29/797,119, filed Jun. 29, 2021, Duhadway.  
 U.S. Appl. No. 29/794,596, filed Jun. 14, 2021, Naylor.  
 U.S. Appl. No. 29/794,737, filed Jun. 25, 2021, Duhadway.  
 U.S. Appl. No. 29/796,882, filed Jun. 28, 2021, Duhadway.  
 U.S. Appl. No. 29/794,743, filed Jun. 15, 2021, Duhadway.  
 U.S. Appl. No. 29/801,171, filed Jul. 27, 2021, Duhadway.  
 U.S. Appl. No. 29/801,173, filed Jul. 27, 2021, Naylor.  
 U.S. Appl. No. 29/799,389, filed Jul. 14, 2021, Duhadway.  
 U.S. Appl. No. 29/801,175, filed Jul. 27, 2021, Duhadway.  
 U.S. Appl. No. 29/808,729, filed Sep. 22, 2021, Duhadway.  
 U.S. Appl. No. 29/808,735, filed Sep. 22, 2021, Duhadway.  
 U.S. Appl. No. 29/814,099, filed Nov. 3, 2021, Naylor.  
 U.S. Appl. No. 29/818,613, filed Dec. 9, 2021, Beckstead.  
 U.S. Appl. No. 29/818,153, filed Dec. 7, 2021, Duhadway.  
 U.S. Appl. No. 29/818,157, filed Dec. 7, 2021, Duhadway.  
 U.S. Appl. No. 29/815,518, filed Nov. 15, 2021, Packer.  
 U.S. Appl. No. 29/818,147, filed Dec. 7, 2021, Naylor.  
 U.S. Appl. No. 29/823,713, filed Jan. 19, 2022, Duhadway.  
 U.S. Appl. No. 29/823,716, filed Jan. 19, 2022, Duhadway.  
 Electric fireplace, image post date May 26, 2014, site visited Aug. 8, 2016, (online), ><https://www.tineye.com/search/3c3d0cbfb7030b3079ebefa0774a5b4e94120332/?pluginver>.  
 Media Console with Electric Fireplace, image postdate Dec. 6, 2015, site visited Aug. 8, 2016, (online), <<http://www.overstock.com/Home-Garden/Media-Console-with-Electric-Fireplace-in-Barnwood/10309735/product.html?recset=05953330-aaa1-4640-a796-f225c2f8176d&refccid=MRISGBB2MZGZXYKK4EFVI25H6Q&recalg=809,828,512&recidx=1#reviews>.  
 TV Stand With Fireplace, image post date Sep. 12, 2015, site visited Aug. 8, 2016, (online), ><https://www.tineye.com/search/77be8934bf07249cbb245c8ea0f719199437b185/>.  
 Walker Edison TV Stand with Fireplace Insert, image post date Jul. 31, 2015, site visited Aug. 8, 2016, (online), <<https://www.amazon.com/Walker-Edison-Fireplace-Insert-Espresso/dp/BOOPNONTAK>.  
 Manchester Fireplace TV Console, image post date Dec. 17, 2015, site visited Aug. 8, 2016, (online), <<http://www.walmart.com/ip/Manchester-Media-Fireplace-Stand-for-TVs-up-to-70/46360223>.  
 Monet Fireplace; Canadian Tire Company website: <http://www.canadiantire.ca/en/pdp/monet-fireplace-0643572p.html>; retrieved on Dec. 21, 2016.  
 TV and Media Consoles, image post date Sep. 21, 2013, site visited Oct. 26, 2016, (online), <<http://web.archive.org/web/20130921074219/http://www.lectricfireplacesdirect.com/Gallery/tv-and-media-consoles.html>>.\*  
 “Kendall Electric Media Fireplace—Espresso” Dec. 24, 2012, amazon.com, site visited Mar. 6, 2018 <[https://www.amazon.com/Kendall-Electric-Media-Fireplace-Espresso/dp/B009LIT6XQ/ref=cm\\_cr\\_arp\\_d\\_product\\_top?ie=UTF8](https://www.amazon.com/Kendall-Electric-Media-Fireplace-Espresso/dp/B009LIT6XQ/ref=cm_cr_arp_d_product_top?ie=UTF8)> (Year: 2012).\*  
 “Whalen Media Fireplace Console for TVs up to 70” Gray” Nov. 24, 2015, walmart.com, site visited Mar. 6, 2018 <<https://www.walmart.com/ip/Whalen-Media-Fireplace-Console-for-TVs-up-to-70-Gray/54189794>> (Year: 2015).\*  
 “Boston Loft Furnishings . . . ” Nov. 7, 2016, themine.com, site visited Mar. 2, 2018 <<https://www.themine.com/tv-stands/boston->



(56)

## References Cited

## OTHER PUBLICATIONS

loft-furnishings-reamrock-infrared-electric-fireplace-media-stand-with-convertible-corner\_g2733659.html> (Year: 2016).

“Ameriwood Home Everett 70-inch . . .” Dec. 6, 2016, overstock.com, site visited Mar. 2, 2018 ><https://www.overstock.com/Home-Garden/Ameriwood-Home-Everett-70-inch-Sonoma-Oak-TV-Stand-with-Glass-Doors/12710691/product.html>> (Year: 2016).\*

Metal Coffee Table; <https://www.overstock.com/Home-Garden/42-Metal-Coffee-Table-42-x-24-x-18h/15951452/product.html> Retrieved on Nov. 13, 2018.

Modern Two-Tone Writing Desk; <https://www.overstock.com/Home-Garden/44-Modern-Two-Tone-Writing-Desk/19684325/product.html> Retrieved on Nov. 13, 2018.

Czapla TV Stand for TVs up to 65"; <https://www.allmodern.com/furniture/pdp/mercury-row-czapla-tv-stand-for-tvs-up-to-65-a000303456.html> ; Retrieved on May 7, 2019.

Nelson Media Cabinet; <https://www.franceandson.com/collections/storage-shelving-media-cabinets/products/nelson-media-cabinet36051> ; Retrieved on May 7, 2019.

Hal TV Stand for TVs up to 60"; <https://www.allmodern.com/furniture/pdp/hal-tv-stand-for-tvs-up-to-60-a000176456.html> ; Retrieved on May 7, 2019.

Wigington TV Stand for TVs up to 60"; <https://www.allmodern.com/furniture/pdp/wigington-tv-stand-for-tvs-up-to-60-golv3670.html?piid> ; Retrieved on May 7, 2019.

Cliffmay Slat Media Stand Light Oak Brown—Project 62; [https://www.target.com/p/cliffmay-slat-media-stand-light-oak-brown-project-62-153/-/A-53517373?ref=tgt\\_adv\\_XS000000&AFID=google\\_pla\\_df&fndsrc=tgtao&CPNG=PLA\\_Furniture%2BShopping\\_Priority%2BBrands&adgroup=SC\\_Project+62&LID=700000001170770pgs&network=g&device=c&location\\_F9029756&gclsrc=aw.ds&ds\\_rl=1\\_246978&ds\\_rl=1247068&ds\\_rl=1\\_246978&ref=tgt\\_adv\\_XS000000&AFID=google\\_pla\\_df&CPNG=PLA\\_Furniture+Shopping\\_Priority+Brands&adgroup=SC\\_Project%2062&LID=700000001170770pgs&network=g&device=c&location=902\\_9756&gclid=EAIAIQobChMI7Nb9wo-H3wIVBylpCh1fSg4IEAQYBSABEgK\\_yPD\\_BwE&gclsrc=aw.ds](https://www.target.com/p/cliffmay-slat-media-stand-light-oak-brown-project-62-153/-/A-53517373?ref=tgt_adv_XS000000&AFID=google_pla_df&fndsrc=tgtao&CPNG=PLA_Furniture%2BShopping_Priority%2BBrands&adgroup=SC_Project+62&LID=700000001170770pgs&network=g&device=c&location_F9029756&gclsrc=aw.ds&ds_rl=1_246978&ds_rl=1247068&ds_rl=1_246978&ref=tgt_adv_XS000000&AFID=google_pla_df&CPNG=PLA_Furniture+Shopping_Priority+Brands&adgroup=SC_Project%2062&LID=700000001170770pgs&network=g&device=c&location=902_9756&gclid=EAIAIQobChMI7Nb9wo-H3wIVBylpCh1fSg4IEAQYBSABEgK_yPD_BwE&gclsrc=aw.ds) ; Retrieved on May 7, 2019.

Audrey Woven Media Console 65"; <https://www.zinhome.com/audrey-woven-media-console-65/> Retrieved on May 14, 2019.

Demilune Mesh Door Industrial Sideboard; <https://belleescape.com/demilune-mesh-wire-door-industrial-chic-sideboard.html?SID=U> ; Retrieved on May 14, 2019.

Tuk Cabinet; <https://blackroosterdecor.com/collections/storage/products/tuk-cabinet>; Retrieved on May 14, 2019.

Rustic Style 31 Inches Metal TV Stand With Wire Mesh Doors Cabinet, Black <https://casagear.com/products/rustic-style-31-inches-metal-tv-stand-with-wire-mesh-doors-cabinet-black>; May 14, 2019.

Geo-Marquetry Buffet; [https://www.anthropologie.com/shop/geo-marquetry-buffet?adpos=1o27&adtype=pla&cm\\_mm=Google-US%20-%20Shopping%20-%20Furniture-Organizing%20and%20Storage-42699934&color=&countryCode=US&creative=191389729567&device=c&gclid=EAIAIQobChMIvutGgYOH3wIVEdNkCh3t8wRPEAkYGYABEgJG\\_PD\\_BwE&inventoryCountry=US&matchtype=&mrkgadid=3202938336&mrkgcl=694&network=g&product\\_id=42699934&quantity=1&size=ALL&type=STANDARD&utm\\_campaign=US%20-%20Shopping%20-7%20Furniture&utm\\_content=42699934&utm\\_medium=paid\\_search&utm\\_source=Google&utm\\_term=Organizing%20and%20Storage](https://www.anthropologie.com/shop/geo-marquetry-buffet?adpos=1o27&adtype=pla&cm_mm=Google-US%20-%20Shopping%20-%20Furniture-Organizing%20and%20Storage-42699934&color=&countryCode=US&creative=191389729567&device=c&gclid=EAIAIQobChMIvutGgYOH3wIVEdNkCh3t8wRPEAkYGYABEgJG_PD_BwE&inventoryCountry=US&matchtype=&mrkgadid=3202938336&mrkgcl=694&network=g&product_id=42699934&quantity=1&size=ALL&type=STANDARD&utm_campaign=US%20-%20Shopping%20-7%20Furniture&utm_content=42699934&utm_medium=paid_search&utm_source=Google&utm_term=Organizing%20and%20Storage); Retrieved on May 14, 2019.

Suspend II Media Console; <https://www.cb2.com/suspend-ii-media-console/s523915>; Retrieved on May 14, 2019.

Hooker Furniture Melange Mirrored Angle Console [https://www.furniturecrate.com/hooker-melange-mirrored-angle-console.html?gdftrk=gdfV21650\\_a\\_7c92\\_a\\_7c8357\\_a\\_7c654170&gclid=CjwKEAiA05unBRCyMrGilanF9SwSJACqDFRm1WwgePUSp65sXRCI4RkJfScYn-yCjNuB-GTt3W-FxoCQL7w\\_wcB](https://www.furniturecrate.com/hooker-melange-mirrored-angle-console.html?gdftrk=gdfV21650_a_7c92_a_7c8357_a_7c654170&gclid=CjwKEAiA05unBRCyMrGilanF9SwSJACqDFRm1WwgePUSp65sXRCI4RkJfScYn-yCjNuB-GTt3W-FxoCQL7w_wcB); Retrieved on May 14, 2019.

FurnitureMaxx Besteen Contemporary Wood Dark Gray Dining Room Server [https://www.amazon.com/dp/B07GVS1VK2/ref=cm\\_sw\\_r\\_pi\\_dp\\_U\\_x\\_evuOBbFM3298G](https://www.amazon.com/dp/B07GVS1VK2/ref=cm_sw_r_pi_dp_U_x_evuOBbFM3298G); Retrieved on May 14, 2019.

Jaydyn Media TV Stand/Credenza [https://www.macys.com/shop/product/jaydyn-media-tv-stand-credenza?ID=2883210&CategoryID=35319#fn=FURNITURE\\_CATEGORY=Buffet%20&%;20Sideboards&SIZE=&sp=3&spc=131&ruleId=129%7CBOOST%20ATTRIBUTE7CBOOST%20SAVED%20SET&searchPass=matchNone&slotId=2](https://www.macys.com/shop/product/jaydyn-media-tv-stand-credenza?ID=2883210&CategoryID=35319#fn=FURNITURE_CATEGORY=Buffet%20&%;20Sideboards&SIZE=&sp=3&spc=131&ruleId=129%7CBOOST%20ATTRIBUTE7CBOOST%20SAVED%20SET&searchPass=matchNone&slotId=2); Retrieved on May 14, 2019.

Sideboard; <https://www.allmodern.com/furniture/pdp/sideboard-sct11710.html>; Retrieved on May 14, 2019.

Belham Living Trenton Industrial End Table; [https://www.hayneedle.com/product/belham-living-trenton-industrial-end-table-new.cfm?source=pla&kwid=OccasionalTables%20iprefer&tid=REDU113-1&adtype=pla&kw=&gclid=EAIAIQobChMIvOu-6veI3wIVB8ZkChOZdAf-EAkYAyABEgLyMfD\\_BwE](https://www.hayneedle.com/product/belham-living-trenton-industrial-end-table-new.cfm?source=pla&kwid=OccasionalTables%20iprefer&tid=REDU113-1&adtype=pla&kw=&gclid=EAIAIQobChMIvOu-6veI3wIVB8ZkChOZdAf-EAkYAyABEgLyMfD_BwE); Retrieved on May 15, 2019.

Belham Living Hampton Chair Side Table—Black; <https://www.hayneedle.com/product/belham-living-hampton-chair-side-table-black.cfm>; Retrieved on May 15, 2019.

International Concepts Hampton End Table [https://www.hayneedle.com/product/internationalconceptshamptonendtable.cfm?source=pla&kwid=OccasionalTables%20level05&tid=WWI545-1&adtype=pla&kw=&gclid=EAIAIQobChMIpsnoq\\_mI3wIVGNVCh348gtDEAkYliABEgLP7fD\\_BwE](https://www.hayneedle.com/product/internationalconceptshamptonendtable.cfm?source=pla&kwid=OccasionalTables%20level05&tid=WWI545-1&adtype=pla&kw=&gclid=EAIAIQobChMIpsnoq_mI3wIVGNVCh348gtDEAkYliABEgLP7fD_BwE); Retrieved on May 15, 2019.

Hampton Weathered Taupe Gray Coffee Table; [https://www.homedepot.com/p/International-Concepts-Hampton-Weathered-Taupe-Gray-Coffee-Table-OT09-70C/302946359?MERCH=REC\\_-PIPHorizontal2\\_rr\\_-204737265\\_-302946359\\_-N](https://www.homedepot.com/p/International-Concepts-Hampton-Weathered-Taupe-Gray-Coffee-Table-OT09-70C/302946359?MERCH=REC_-PIPHorizontal2_rr_-204737265_-302946359_-N); Retrieved on May 15, 2019.

Convenience Concepts Oxford Rectangle Coffee Table [https://www.hayneedle.com/product/convenience-concepts-oxford-rectangle-coffee-table.cfm?source=pla&kwid=OccasionalTables%20newskus&tid=CONV338-5&adtype=pla&kw=&gclid=EAIAIQobChMIhuzv9\\_mI3wIVWx-tBhirUA1tEAKYHyABEgJ2hPD\\_BwE](https://www.hayneedle.com/product/convenience-concepts-oxford-rectangle-coffee-table.cfm?source=pla&kwid=OccasionalTables%20newskus&tid=CONV338-5&adtype=pla&kw=&gclid=EAIAIQobChMIhuzv9_mI3wIVWx-tBhirUA1tEAKYHyABEgJ2hPD_BwE); Retrieved on May 15, 2019.

Belham Living Jamestown Rustic Coffee Table with Unique Driftwood Finish <https://www.hayneedle.com/product/jamestown-rustic-coffee-table.cfm>; Retrieved on May 15, 2019.

Pinterest; [www.pinterest.com/pin/336328451393621/](http://www.pinterest.com/pin/336328451393621/); Retrieved on Jun. 12, 2019.

Target Winham TV Stand—Threshold; [www.target.com/p/windham-tv-stand-threshold-153/-/A-54301349](http://www.target.com/p/windham-tv-stand-threshold-153/-/A-54301349); Retrieved on Jun. 12, 2019.

Pinterest DIY Farmhouse Coffee Table Cabinet; [www.pinterest.com/pin/33636328450994833/](http://www.pinterest.com/pin/33636328450994833/) Retrieved on Jun. 12, 2019.

Image seen on Pinterest DIY Project; Pinterest.com; Seen approximately Aug. 1, 2017.

World Market—Metal Bexley Bar; [www.worldmarket.com/product/metal+bexley+bar.do?pp=1](http://www.worldmarket.com/product/metal+bexley+bar.do?pp=1) ; Retrieved on Sep. 25, 2019.

Overstock—Nova Domus Soria Modern Walnut TV Stand; [https://www.overstock.com/Home-Garden/Nova-Domus-Soria-Modern-Walnut-TV-Stand/10359356/product.html?utm\\_campaign=pin\\_button&utm\\_medium=Social&utm\\_source=Pinterest](https://www.overstock.com/Home-Garden/Nova-Domus-Soria-Modern-Walnut-TV-Stand/10359356/product.html?utm_campaign=pin_button&utm_medium=Social&utm_source=Pinterest) Retrieved on Jun. 12, 2019.

Notice of Allowance for U.S. Appl. No. 29/654,936 dated Jun. 19, 2019.

Notice of Allowance for U.S. Appl. No. 29/656,479 dated Jun. 27, 2019.

Restriction Requirement for U.S. Appl. No. 29/654,950 dated Sep. 25, 2019.

Office Action for U.S. Appl. No. 29/656,489 dated Sep. 25, 2019.

Office Action for U.S. Appl. No. 29/656,497 dated Sep. 25, 2019.

Office Action for U.S. Appl. No. 29/656,499, dated Sep. 26, 2019.

Notice of Allowance for U.S. Appl. No. 29/656,486 dated Sep. 27, 2019.

Notice of Allowance for U.S. Appl. No. 29/656,485 dated Oct. 2, 2019.

Notice of Allowance for U.S. Appl. No. 29/656,479 dated Oct. 21, 2019.

Office Action for U.S. Appl. No. 29/654,952 dated Nov. 15, 2019.

Notice of Allowance for U.S. Appl. No. 29/656,492 dated Nov. 18, 2019.



(56)

## References Cited

## OTHER PUBLICATIONS

42 in. Metal and Wood Desk with Glass and Shelf Grey Wash by Walker Edison Furniture Company—Home Depot <https://www.homedepot.com/p/Walker-Edison-Furniture-Company-42-in-Metal-and-Wood-Desk-with-Glass-and-Shelf-Grey-Wash-HDM42JERGW/305309102> retrieved from the internet on Sep. 9, 2019.

Dark Walnut Wood and Glass Coffee Table by Walker Edison Furniture Company—Home Depot <https://www.homedepot.com/p/Walker-Edison-Furniture-Company-Dark-Walnut-Wood-and-Glass-Coffee-Table-HDF42JMGLDW/305308482> retrieved from the internet on Nov. 6, 2019.

“Baum TV Stand for TVs up to 58 inches” Wayfair. (Accessed Nov. 14, 2019).

“Dark Walnut 70" TV Stand” Pieri. (Accessed Nov. 14, 2019).

“Seren TV Stand for TVs up to 50 inches” Wayfair. (Accessed Nov. 14, 2019).

“Shreffler TV Stand for TVs up to 78 inches” Wayfair. (Accessed Nov. 14, 2019).

Office Action for U.S. Appl. No. 29/634,946 dated Dec. 12, 2019. Notice of Allowance for U.S. Appl. No. 29/656,485 dated Dec. 18, 2019.

Notice of Allowance for U.S. Appl. No. 29/654,950 dated Dec. 27, 2019.

Electric Fireplaces Direct.com. <https://www.electricfireplacesdirect.com/products-accessories/tv-media-consoles/shelby-electric-fireplace-media-console-in-white-c3p18c9-2030w.html>. “Shelby Electric Fireplace Media Console in White”. Date unknown: Viewed Dec. 2019 (Year: 2019).

Pikove. <https://pikove.com/media/509962357792326443>. “Home Decor”. Feb. 2017 (Year: 2017).

Luno. <https://iamluno.com/product/kc27-record-console-new/>. “KC27 Hifi Record Console”. Date unknown: Viewed Dec. 2019 (Year: 2019).

Notice of Allowance for U.S. Appl. No. 29/656,499 dated Jan. 23, 2020.

Notice of Allowance for U.S. Appl. No. 29/656,497 dated Jan. 23, 2020.

Notice of Allowance for U.S. Appl. No. 29/656,489 dated Jan. 24, 2020.

Walker Edison Buffet 52' Console Table; <https://www.walkerredison.com/buffet-52-console-table.html> Retrieved on Jul. 19, 2018.

Notice of Allowance for U.S. Appl. No. 29/654,952 dated Feb. 12, 2020.

Restriction Requirement for U.S. Appl. No. 29/714,849 dated Feb. 25, 2020.

Notice of Allowance for U.S. Appl. No. 29/714,849 dated Apr. 6, 2020.

Notice of Allowance for U.S. Appl. No. 29/634,946 dated Apr. 8, 2020.

Notice of Allowance for U.S. Appl. No. 29/654,952 dated Apr. 21, 2020.

Pinterest; Cabinet Furniture; wood veneer sideboard with doors—Edge Collection by Miniforms <https://www.pinterest.com/pin/312366924137895643/>; Retrieved on Aug. 9, 2018.

Edge Buffet and Cabinet; Miniforms.com; [https://www.miniforms.com/en/products/4\\_buffet-and-cabinet/105\\_edge/#f](https://www.miniforms.com/en/products/4_buffet-and-cabinet/105_edge/#f); Retrieved on Aug. 9, 2018.

Pinterest; Media Furniture Search; <https://www.pinterest.com/pin/33636328451628908/>; Retrieved on Apr. 16, 2018.

Pinterest; Furniture Search; <https://www.pinterest.com/pin/33636328453466237/>; Retrieved on Apr. 11, 2018.

Office Action for U.S. Appl. No. 29/677,738 dated Jun. 26, 2020.

Office Action for U.S. Appl. No. 29/677,723 dated Jun. 26, 2020.

“Walker Edison—W60NOR2D Assembly Instructions.” Found online Jun. 19, 2020 at [www.walkerredison.com](http://www.walkerredison.com). Page dated Apr. 23, 2018. Retrieved from URL <https://www.walkerredison.com/uploads/5/8/2/2/58227457/ai-w60nor2d-%C2%AE%20version%20042318-e.pdf> (Year: 2018).

“The Urban Port Mid Century Modern Acacia Wood TV Unit.” Found online Jun. 19, 2020 at [www.amazon.com](http://www.amazon.com). Product reviewed

Jun. 28, 2018. Retrieved from URL <https://www.amazon.com/dp/B07P6QPSYJ/ref=sbl dpx B07LG44BN6 0?th=1> (Year: 2018).

“Simpli Home Draper Solid Wood Universal Low TV Media Stand.” Found online Jun. 19, 2020 at [www.amazon.com](http://www.amazon.com). Product reviewed Sep. 26, 2016. Retrieved from URL <https://www.amazon.com/dp/B01AACK5FM/ref=sbl dpx B082WLRSMS 0?th=1> (Year: 2016).

“Iwell Mid-Century Modern TV Stand.” Found online Jun. 20, 2020 at [www.amazon.com](http://www.amazon.com). Product first available May 7, 2020. Retrieved from URL: <https://tinyurl.com/y9okn5lq> (Year: 2020).

“Tangkula Wooden TV Stand.” Found online Jun. 20, 2020 at [www.amazon.com](http://www.amazon.com). Product first available Jan. 13, 2020. Retrieved from URL: <https://tinyurl.com/y9h9hwwc> (Year: 2020).

“Langley Street Silvia 54-inch TV Stand.” Found online Jun. 20, 2020 at [www.amazon.com](http://www.amazon.com). Product first available Aug. 30, 2015. Retrieved from URL: <https://www.amazon.com/dp/B07BMM7PZ6/ref=sbl dpx B01255EZVW 0> (Year: 2015).

“Walker Edison—W70JACSD Assembly Instructions.” Found online Jun. 19, 2020 at [www.walkerredison.com](http://www.walkerredison.com). Page dated Jul. 9, 2018. Retrieved from URL <https://www.walkerredison.com/uploads/5/8/2/2/58227457/ai-w70jacsd-%C2%AE%20version%20071118-n.pdf> (Year: 2018).

“South Shore Exhibit TV Stand.” Found online Jun. 19, 2020 at [www.amazon.com](http://www.amazon.com). Product reviewed Jan. 12, 2017. Retrieved from URL: <https://www.amazon.com/dp/B01D9MW9FE/ref=sbl dpx B01AACK5FM 0?th=1> (Year: 2017).

“Sauder Coral Cape Contemporary Wood 70-inch TV Stand.” Found online Jun. 19, 2020 at [www.amazon.com](http://www.amazon.com). Product first available Jan. 28, 2020. Retrieved from URL <https://www.amazon.com/dp/B085VKFXJF/ref=sbl dpx B07LG44BN6 0> (Year: 2020).

“CCT Global Sourcing Inc. Pearson Solid Hardwood 60-inch TV Stand.” Found online Jun. 19, 2020 at [www.amazon.com](http://www.amazon.com). Product first available Jan. 20, 2020. Retrieved from URL <https://www.amazon.com/dp/B0842JT1Z6/ref=sbl dpx B07LG44BN6 0> (Year: 2020).

Notice of Allowance for U.S. Appl. No. 29/677,722 dated Jul. 1, 2020.

“Walker Edison—W58BMHPAS Assembly Instructions.” Found online Jun. 19, 2020 at [www.walkerredison.com](http://www.walkerredison.com). Page dated Apr. 23, 2018. Retrieved from URL <https://www.walkerredison.com/uploads/5/8/2/2/58227457/ai-w58bnnhpas-%C2%AE%20version%20042318-e.pdf> (Year: 2018).

“Mid Century Modern TV Stand.” Found online Jun. 20, 2020 at [www.amazon.com](http://www.amazon.com). Product first available Jun. 16, 2020. Retrieved from URL: <https://tinyurl.com/y7qolcv7> (Year: 2020).

“Pemberly Row Modern Mid Century Entertainment TV Stand.” Found online Jun. 20, 2020 at [www.amazon.com](http://www.amazon.com). Product first available May 25, 2018. Retrieved from URL: <https://tinyurl.com/y9affau7> (Year: 2018).

Notice of Allowance for U.S. Appl. No. 29/677,724 dated Jul. 7, 2020.

“Walker Edison—W60S014D Assembly Instructions.” Found online Jun. 19, 2020 at [www.walkerredison.com](http://www.walkerredison.com). Page dated May 8, 2018. Retrieved from URL <https://www.walkerredison.com/uploads/5/8/2/2/58227457/ai-w60soi4d-%C2%AE%20version%20050818-n.pdf> (Year: 2018).

“Sauder Boulevard Cafe Credenza.” Found online Jun. 19, 2020 at [www.amazon.com](http://www.amazon.com). Product first available Aug. 23, 2018. Retrieved from URL: [https://www.amazon.com/Sauder-420649-Boulevard-Credenza-Vintage/dp/B07GSJ4MG1/ref=psdc\\_14109851t1B07G62YLVLT](https://www.amazon.com/Sauder-420649-Boulevard-Credenza-Vintage/dp/B07GSJ4MG1/ref=psdc_14109851t1B07G62YLVLT) (Year: 2018).

“Martin Furniture Eclectic Harmon Four Door Console.” Found online Jun. 19, 2020 at [www.amazon.com](http://www.amazon.com). Product first available Oct. 30, 2017. Retrieved from URL <https://www.amazon.com/dp/B076VVYRPR/ref=sbl dpx B07G62YLVLT 0> (Year: 2017).

“Industrial Iron Mesh Sideboard Media Cabinet.” Found online Jun. 19, 2020 at [www.amazon.com](http://www.amazon.com). Product first available Jul. 20, 2015. Retrieved from URL <https://www.amazon.com/dp/B01255EZVW/ref=sbl dpx B07G62YLVLT 0> (Year: 2015).

Safavieh Furniture <http://web.archive.org/web/20130301232929/http://safavieh.com/furniture/categories/bookcases?pg=all> Retrieved online on Aug. 5, 2020.



(56)

## References Cited

## OTHER PUBLICATIONS

Safavieh Furniture; <http://web.archive.org/web/20140713025018/http://safavieh.com/furniture/american-home/bookcases/amh6525a>; Retrieved online on Aug. 5, 2020.

Amarah Mid Century Modern Wood TV Stand by Christopher Knight Home <https://web.archive.org/web/20181102021725/https://www.overstock.ca/Home-Garden/Amarah-Mid-century-Modern-Wood-TV-Stand-by-Christopher-Knight-Home/18108793/product.html>; Retrieved online on Aug. 5, 2020.

Gemini Wood Contemporary TV Stand <https://web.archive.org/web/20160423180238/https://www.target.com/p/gemini-wood-contemporary-tv-stand-walnut-white-66-baxton-studio/-/A-50256043>; Retrieved online on Aug. 5, 2020.

Article SENO walnut media unit <http://web.archive.org/web/20170610131805/https://www.article.com/product/1635/seno-walnut-63-media-unit>; Retrieved online on Aug. 5, 2020.

Instagram post—Article Seno walnut media unit; <https://www.instagram.com/p/BhcCAZIH8-q>; Retrieved on Aug. 5, 2020.

Convenience Concepts Designs2Go Oslo TV Stand; <https://www.amazon.ca/Convenience-Concepts-Designs2Go-Stand-White/dp/B011RACHQ6/?th=1>; Retrieved online on Aug. 5, 2020.

Houzz\_Rowan\_Mid-Century Modern Two-Toned TV Stand; <https://www.houzz.com/products/rowan-mid-century-modern-two-toned-tv-stand-white-oak-prvw-vr-74489612>; Retrieved online on Aug. 21, 2020.

Focus On Furniture, Lowline TV Units <https://web.archive.org/web/20170218071314/https://www.focusonfurniture.com.au/living-room/lowline-tv-units/>; Retrieved on Aug. 21, 2020.

Office Action for U.S. Appl. No. 29/654,930, dated Aug. 21, 2020. Calie TV Stand for TVs up to 48 inches with Electric Fireplace Included; Wayfair.com <https://www.wayfair.com/furniture/pdp/real-flame-calie-tv-stand-for-tvs-up-to-48-inches-with-electric-fireplace-included-jfp1647.html>; Retrieved on Jan. 10, 2018.

Restriction Requirement for U.S. Appl. No. 29/698,919, dated Aug. 27, 2020.

Office Action for U.S. Appl. No. 29/677,755, dated Aug. 27, 2020. Foundry Arsenault End Table, www.wayfair.com [online]. Published on or before Aug. 15, 2020, [retrieved on Aug. 15, 2020], Retrieved from the Internet: <URL:<https://www.wayfair.ca/furniture/pdp/foundry-select-arsenault-4-legs-end-table-c003160002.html?piid=1664365403>> (Year: 2020).

Office Action for U.S. Appl. No. 29/698,928, dated Aug. 28, 2020. Notice of Allowance for U.S. Appl. No. 29/698,940, dated Aug. 28, 2020.

Rustic Farmhouse Corner TV Stand With Barn Doors, Little Rustic Shop, site visited Aug. 24, 2020, available online at <https://littlerusticshop.com/collections/frontpage/products/rustic-farmhouse-corner-tv-stand-with-barn-doors> (Year: 2020).

Office Action for U.S. Appl. No. 29/698,947, dated Aug. 31, 2020. White Eliza TV Stand With Fireplace Insert, Owens Home Furnishings, site visited Aug. 25, 2020, available online at <https://www.owensfurniture.com/eliza-white-barn-door-tv-stand-70/> (Year: 2020).

Office Action for U.S. Appl. No. 29/698,942, dated Aug. 31, 2020. Office Action for U.S. Appl. No. 29/677,761, dated Sep. 1, 2020.

Foundry Select Arsenault Coffee Table, www.wayfair.ca [online]. Published on or before Aug. 11, 2020, [retrieved on Aug. 11, 2020], Retrieved from the Internet <URL:<https://www.wayfair.ca/furniture/pdp/foundry-select-arsenault-coffee-table-c003159996.html>> (Year: 2020).

Notice of Allowance for U.S. Appl. No. 29/699,063, dated Sep. 2, 2020.

Notice of Allowance for U.S. Appl. No. 29/699,071, dated Sep. 4, 2020.

Notice of Allowance for U.S. Appl. No. 29/699,066, dated Sep. 11, 2020.

Notice of Allowance for U.S. Appl. No. 29/677,723, dated Sep. 15, 2020.

Notice of Allowance for U.S. Appl. No. 29/677,738, dated Sep. 15, 2020.

Notice of Allowance for U.S. Appl. No. 29/698,942, dated Sep. 15, 2020.

Office Action for U.S. Appl. No. 29/698,924, dated Sep. 16, 2020. Notice of Allowance for U.S. Appl. No. 29/699,073, dated Sep. 16, 2020.

Corrected Notice of Allowance for U.S. Appl. No. 29/698,942, dated Sep. 23, 2020.

Notice of Allowance for U.S. Appl. No. 29/677,723, dated Sep. 29, 2020.

Notice of Allowance for U.S. Appl. No. 29/677,738, dated Sep. 29, 2020.

Notice of Allowance for U.S. Appl. No. 29/720,732; dated Sep. 29, 2020.

Notice of Allowance for U.S. Appl. No. 29/721,435, dated Sep. 29, 2020.

Notice of Allowance for U.S. Appl. No. 29/677,724, dated Sep. 30, 2020.

Notice of Allowance for U.S. Appl. No. 29/699,071, dated Sep. 30, 2020.

Notice of Allowance for U.S. Appl. No. 29/720,923, dated Sep. 30, 2020.

Office Action for U.S. Appl. No. 29/699,078, dated Oct. 6, 2020. “WE Furniture AZ40SWICTWMDC Coffee Table.” Found online Sep. 30, 2020 at [www.amazon.com](http://www.amazon.com). Product first available Jan. 23, 2019 Retrieved from URL: [https://www.amazon.com/-/es/Furniture-AZ40SWICTWMDC-centro-Madera-Vidrio/dp/B07N282396/ref=psdc\\_3733631\\_J2\\_B07CYML1LF](https://www.amazon.com/-/es/Furniture-AZ40SWICTWMDC-centro-Madera-Vidrio/dp/B07N282396/ref=psdc_3733631_J2_B07CYML1LF) (Year 2019).

“Vasagle Glatal Glass Coffee Table.” Found online Sep. 30, 2020 at [www.amazon.com](http://www.amazon.com). Product first available May 1, 2020. Retrieved from URL: <https://tinyurl.com/yxvuv2rf> (Year: 2020).

“Henn and Hart Coffe Table.” Found online Sep. 30, 2020 at [www.amazon.com](http://www.amazon.com). Product first available Jan. 20, 2019. Retrieved from URL: [https://www.amazon.com/-/es/Henn-Hart-talla-%C3%BA-nica-color/dp/B07N8RRPT5/ref=psdc\\_3733631\\_t5\\_B07CYML1LF](https://www.amazon.com/-/es/Henn-Hart-talla-%C3%BA-nica-color/dp/B07N8RRPT5/ref=psdc_3733631_t5_B07CYML1LF) (Year: 2019).

Notice of Allowance for U.S. Appl. No. 29/677,755, dated Oct. 27, 2020.

Notice of Allowance for U.S. Appl. No. 29/720,923, dated Oct. 28, 2020.

Lorraine TV Stand for TVs up to 60 Retrieved online Nov. 3, 2020; from URL <https://www.wayfair.com/furniture/pdp/three-posts-lorraine-tv-stand-for-tvs-up-to-60-w001527559.html>.

Notice of Allowance for U.S. Appl. No. 29/698,942, dated Nov. 3, 2020.

Notice of Allowance for U.S. Appl. No. 29/699,073, dated Nov. 3, 2020.

Notice of Allowance for U.S. Appl. No. 29/721,435, dated Nov. 3, 2020.

“Alera Angled Doors Oak Wood Black Sideboard” <https://www.decorpad.com/bookmark.htm?bookmarkId=69182> (Retrieved Nov. 12, 2020).

“Linus Base Cabinet w/Double Angled Doors by HABA, 460499\*” <https://gresscoltd.com/linus-base-cabinet-w-double-angled-doors-by-haba-460499.html> (Retrieved Nov. 12, 2020).

“Solid Acacia Wood Canyon Ridge Three Drawer Media TV Console ith Metal Base” <https://www.hootjudkins.com/solid-acacia-wood-canyon-ridge-three-drawer-media-tv-console-with-metal-base> (Retrieved Nov. 12, 2020).

Office Action for U.S. Appl. No. 29/756,291, dated Nov. 23, 2020. Barn Door Console, @sarahashleyallen on Instagram, Dec. 26, 2016, site visited Nov. 18, 2020, available online at <https://www.instagram.com/p/BOFH8jqgzjK/?taken-by=sarahashleyallen> (Year: 2016).

DIY Barn Door Hardware, Ana White, Oct. 17, 2018, site visited Nov. 18, 2020, available online at <https://www.ana-white.com/woodworking-projects/diy-barn-door-hardware-washers> (Year: 2018).

Office Action for U.S. Appl. No. 29/698,919, dated Nov. 24, 2020.

DIY Sliding Barn Door Console, Jaime Costiglio, Jan. 1, 2019, site visited Nov. 18, 2020, available online at <https://jaimecostiglio.com/diy-sliding-barn-door-console-free-plans/> (Year: 2019).

Notice of Allowance for U.S. Appl. No. 29/654,930, dated Dec. 10, 2020.



(56)

## References Cited

## OTHER PUBLICATIONS

Notice of Allowance for U.S. Appl. No. 29/698,947, dated Dec. 10, 2020.

Notice of Allowance for U.S. Appl. No. 29/698,928, dated Dec. 11, 2020.

Notice of Allowance for U.S. Appl. No. 29/698,924, dated Dec. 18, 2020.

Notice of Allowance for U.S. Appl. No. 29/677,761, dated Dec. 22, 2020.

Notice of Allowance for U.S. Appl. No. 29/756,763, dated Dec. 22, 2020.

Notice of Allowance for U.S. Appl. No. 29/720,732; dated Jan. 25, 2021.

Notice of Allowance for U.S. Appl. No. 29/699,078, dated Jan. 28, 2021.

Studio 350 Wood Cabinet; retrieved on Mar. 11, 2021; <https://www.overstock.com/Home-Garden/Studio-350-Wood-Cabinet-30-inches-wide-34-inches-high/17357264/product.html>.

Amazon Brand—Rivet Mid-Century Modern Checkerboard Reclaimed Elm Buffet Sideboard Credenza Cabinet; retrieved on Mar. 11, 2021; [https://www.amazon.com/Rivet-Mid-Century-Checkerboard-Reclaimed-Cabinet/dp/B075Z8628K/ref=h\\_npb\\_a2a\\_sims\\_1?encoding=UTF8&pd\\_rd\\_i=B075Z8628K&pd\\_rd\\_r=a9f26748-f7ef-11e8-bd88-f19ea5af337e&pd\\_rd\\_w=LLe5w&pd\\_rd\\_wg=SDrAx&pf\\_rd\\_i=desktop-dp-sims&pf\\_rd\\_m=ATVPDKIKXODER&pf\\_rd\\_p=31feaa4d-b746-4950-83b6-1e38b78bee56&pf\\_rd\\_r=9MFY1C4VSTB9H8PGVEGJ&pf\\_rd\\_s=desktop-dp-sims&pf\\_rd\\_t=40701&psc=1&refRID=9MFY1C4VSTB9H8PGVEGJ](https://www.amazon.com/Rivet-Mid-Century-Checkerboard-Reclaimed-Cabinet/dp/B075Z8628K/ref=h_npb_a2a_sims_1?encoding=UTF8&pd_rd_i=B075Z8628K&pd_rd_r=a9f26748-f7ef-11e8-bd88-f19ea5af337e&pd_rd_w=LLe5w&pd_rd_wg=SDrAx&pf_rd_i=desktop-dp-sims&pf_rd_m=ATVPDKIKXODER&pf_rd_p=31feaa4d-b746-4950-83b6-1e38b78bee56&pf_rd_r=9MFY1C4VSTB9H8PGVEGJ&pf_rd_s=desktop-dp-sims&pf_rd_t=40701&psc=1&refRID=9MFY1C4VSTB9H8PGVEGJ).

Notice of Allowance for U.S. Appl. No. 29/720,093, dated Mar. 12, 2021.

1stopbedrooms, <https://www.1stopbedrooms.com/ramona-autumn-bronze-media-console-electric-fireplace-with-acrylic-ice-xhd-firebox>. “Ramona Autumn Bronze Media Console Electric Fireplace with Acrylic Ice Xhd Firebox”. Date Unknown: Viewed Feb. 2021 (Year: 2021).

Office Action for U.S. Appl. No. 29/756,291, dated Mar. 18, 2021. “Pemberly Row 32-inch Farmhouse Sliding Barn Door Wood Accent Chest.” Found online Mar. 4, 2021 at [www.amazon.com](http://www.amazon.com). Product first available Dec. 28, 2018. Retrieved from URL <https://www.amazon.com/Pemberly-Row-Sliding-Console-Barnwood/dp/B07MQGF51Y> (Year: 2018).

“Walker Edison Abbey Modern Farmhouse Sliding X Barn Door Accent Console.” Found online Mar. 4, 2021 at [www.amazon.com](http://www.amazon.com). Customer question answered Apr. 15, 2019. Retrieved from URL <https://tinyurl.com/36keempk> (Year: 2019).

Notice of Allowance for U.S. Appl. No. 29/698,919; dated Mar. 30, 2021.

Bridgeport by Hopewood; Found online on Mar. 29, 2021 at <https://hubbingtons.com/product-category/bridgeport-by-hopewood/>.

Bridgeport Furniture; Found online on Mar. 29, 2021 at [www.flemingtondepartmentstore.com/all/bridgeport/brand-collection.aspx](http://www.flemingtondepartmentstore.com/all/bridgeport/brand-collection.aspx).

Bridgeport 3-Door Server; Found online on Mar. 29, 2021; Found online at [https://www.belfortfurniture.com/\(X\(1\)\)/item/dining-bridgeport-3-door-server/307396660](https://www.belfortfurniture.com/(X(1))/item/dining-bridgeport-3-door-server/307396660).

Office Action for U.S. Appl. No. 29/756,763; dated Apr. 12, 2021. Gray Barn Wind Gap Sliding Barn Door TV Stand Console, [overstock.com](http://overstock.com), review date with photo from Apr. 8, 2019 & Jul. 10, 2019, <https://www.overstock.com/Home-Garden/The-Gray-Barn-Wind-Gap-Sliding-Barn-Door-TV-Stand-Console/25490525/product.html> (Year: 2019).

Notice of Allowance for U.S. Appl. No. 29/743,416; dated Apr. 21, 2021.

Console, Item# W58SGRD Assembly Instructions; found online Jul. 2, 2020; retrieved on May 3, 2021, (Online); [https://www.overstock.com/downloads/pdf/1219684877\\_1dbe384b-588a-3260-a4d9-6d3bac52ba4a.pdf](https://www.overstock.com/downloads/pdf/1219684877_1dbe384b-588a-3260-a4d9-6d3bac52ba4a.pdf).

Renegar 2 Door Accent Cabinet; Wayfair.com; found online Apr. 21, 2021; retrieved May 3, 2021 (online) <https://www.wayfair.com/furniture/pdp/gracie-oaks-renegar-2-door-accent-cabinet-w001524010.html>.

Guadalupe TV Stand; Wayfair.com; found online Apr. 21, 2021; retrieved May 4, 2021 (online) <https://www.wayfair.com/furniture/pdp/guadalupe-tv-stand-for-tvs-up-to-65-w003233469.html?piid=848017954>.

Corsham TV Stand; Wayfair.com; found online Apr. 21, 2021; retrieved May 4, 2021 (online) <https://www.wayfair.com/furniture/pdp/rosalind-wheeler-corsham-tv-stand-for-tvs-up-to-65-w003211663.html>.

Everitt TV Stand; Wayfair.com; found online Apr. 21, 2021; retrieved May 4, 2021 (online) <https://www.wayfair.com/furniture/pdp/gracie-oaks-everitt-tv-stand-for-tvs-up-to-65-w001524186.html?piid=1788638279>.

Guadalupe TV Stand with Electric Fireplace; Wayfair.com; found online Apr. 21, 2021; retrieved May 4, 2021 (online); <https://www.wayfair.com/furniture/pdp/guadalupe-tv-stand-for-tvs-up-to-65-with-electric-fireplace-included-w003233344.html>.

Brianna TV Stand; Wayfair.com; found online Apr. 21, 2021; retrieved May 4, 2021 (online) <https://www.wayfair.com/furniture/pdp/coastal-farmhouse-brianna-tv-stand-for-tvs-up-to-80-w004028674.html>.

Fryar TV Stand; Wayfair.com; found online Apr. 21, 2021; retrieved May 4, 2021 (online) <https://www.wayfair.com/furniture/pdp/gracie-oaks-fryar-tv-stand-for-tvs-up-to-75-w001713808.html>.

Polegate TV Stand; Wayfair.com; found online Apr. 21, 2021; retrieved May 4, 2021 (online) <https://www.wayfair.com/furniture/pdp/three-posts-teen-polegate-tv-stand-for-tvs-up-to-70-w000171190.html>.

Brawley TV Stand; Wayfair.com; found online Apr. 21, 2021; retrieved May 4, 2021 (online) <https://www.wayfair.com/furniture/pdp/17-stories-brawley-tv-stand-for-tvs-up-to-65-w004231614.html>.

Lorraine TV Stand; Wayfair.com; found online Apr. 21, 2021; retrieved May 4, 2021 (online) <https://www.wayfair.com/furniture/pdp/three-posts-lorraine-tv-stand-for-tvs-up-to-60-w001527559.html>.

Skofte TV Stand; Wayfair.com; found online Apr. 21, 2021; retrieved May 4, 2021 (online) <https://www.wayfair.com/furniture/pdp/gracie-oaks-skofte-tv-stand-for-tvs-up-to-60-w001487399.html>.

Miah TV Stand; Wayfair.com; found online Apr. 21, 2021; retrieved May 4, 2021 (online) <https://www.wayfair.com/furniture/pdp/rosalind-wheeler-miah-tv-stand-for-tvs-up-to-60-w002831147.html>.

Grendel TV Stand; Wayfair.com; found online Apr. 21, 2021; retrieved May 4, 2021 (online) <https://www.wayfair.com/furniture/pdp/gracie-oaks-grendel-tv-stand-for-tvs-up-to-65-w003337326.html>.

Heger TV Stand; Wayfair.com; found online Apr. 21, 2021; retrieved May 4, 2021 (online) <https://www.wayfair.com/furniture/pdp/gracie-oaks-heger-tv-stand-for-tvs-up-to-65-w002101430.html>.

Erwine TV Stand; Wayfair.com; found online Apr. 21, 2021; retrieved May 4, 2021 (online) [https://www.wayfair.com/furniture/pdp/gracie-oaks-erwine-tv-stand-for-tvs-up-to-65-w004339905.htm?categoryid=1868409&placement=3&slot=4&sponsoredid=Oca938f17db89643b10f637f9b2b9c0dba95bcc09d09607add3721\\_a8aOb5e2dc&\\_txid=%2FemXF%2B1T41hnharBpMJA%3D%3D&isB2b=0&auctionid=f9be48b1-Qbcd-4aaf-b285-dbb3ea880db5](https://www.wayfair.com/furniture/pdp/gracie-oaks-erwine-tv-stand-for-tvs-up-to-65-w004339905.htm?categoryid=1868409&placement=3&slot=4&sponsoredid=Oca938f17db89643b10f637f9b2b9c0dba95bcc09d09607add3721_a8aOb5e2dc&_txid=%2FemXF%2B1T41hnharBpMJA%3D%3D&isB2b=0&auctionid=f9be48b1-Qbcd-4aaf-b285-dbb3ea880db5).

Sliding Barn Door Television Stand; Amazon.com; found online Apr. 21, 2021; retrieved May 4, 2021 (online); [https://www.amazon.com/Home-Accent-Furnishings-Sliding-Television/dp/B07DKX44QQ/ref=sr\\_1\\_6?dchild=1&keywords=sliding+barn-i-door-i-tv+stand&qid=1603301187&sr=8-6](https://www.amazon.com/Home-Accent-Furnishings-Sliding-Television/dp/B07DKX44QQ/ref=sr_1_6?dchild=1&keywords=sliding+barn-i-door-i-tv+stand&qid=1603301187&sr=8-6).

Farmhouse Sliding Barn Door TV Stand; Amazon.com; found online Apr. 21, 2021; retrieved May 4, 2021 (online); [https://www.amazon.com/Rainbow-Sophia-Forest-Wooden-Sliding/dp/B081VWRSLK/ref=sr\\_1\\_2?dchild=1&keywords=sliding+barn+door+tv+stand&qid=1603301187&sr=8-2](https://www.amazon.com/Rainbow-Sophia-Forest-Wooden-Sliding/dp/B081VWRSLK/ref=sr_1_2?dchild=1&keywords=sliding+barn+door+tv+stand&qid=1603301187&sr=8-2).

GHQME Sliding Barn Door TV Stand; Amazon.com; found online Apr. 21, 2021; retrieved May 4, 2021 (online); [https://www.amazon.com/GHQME-Table%EF%BC%8CWood-Universal-Stand%EF%BC%8CLiving-Entertainment/dp/B083BJR9YF/ref=sr\\_1\\_1\\_sspa?](https://www.amazon.com/GHQME-Table%EF%BC%8CWood-Universal-Stand%EF%BC%8CLiving-Entertainment/dp/B083BJR9YF/ref=sr_1_1_sspa?)



(56)

## References Cited

## OTHER PUBLICATIONS

dchild=1&keywords=sliding+barn+door+tv+stand&qid=1603301187&sr=8-1-spons&psc=1&spLa=ZW5jenlwdGVkUXVhbGlmaWVyPUExVTAYT1hNVDklVIVRjMvUyY3J5cHRIZElkPUeWmJgxmJgwMVVKTE5HRkdKROUyTCZlbnNyeXBOZWRBZEIkPUeWmNzQ5NzU4M1BENOWyMFpMNUgxQSZ3aWRnZXROYW1IPXNwX2FOZiZhY3Rpb249Y2xpY2tSZWRpcmVjdCZkb05vdExvZONsaWNrPXRYdWU=.

Pamari Wrangler Sliding Barn Door TV Stand; Amazon.com; found online Apr. 21, 2021; retrieved May 4, 2021 (online); [https://www.amazon.com/dp/B07KSMQH4D/refdp\\_cr\\_wdg\\_tit\\_nw\\_mr](https://www.amazon.com/dp/B07KSMQH4D/refdp_cr_wdg_tit_nw_mr).

The Gray Barn Berkley TV Stand; Overstock.com; found online Apr. 21, 2021; retrieved May 4, 2021 (online); <https://www.overstock.com/Home-Garden/Convenience-Concepts-Blake-Barn-Door-TV-Stand/28387177/product.html?recalg=954%2C873%2C839&recidx=2&recset=Oa8617dc-Od40-4dcf-b57f-7220ec2436da&refccid=2NUDSESYZPUIPKBLPZR6M7VUE>.

The Gray Barn Ansley Media Console; Overstock.com; found online Apr. 21, 2021; retrieved May 4, 2021 (online); <https://www.overstock.com/Home-Garden/Entertainment-Centers/2029/subcat.html?featuredproduct=31934591>.

Barn Door Rustic TV Stand; Overstock.com; found online Apr. 21, 2021; retrieved May 4, 2021 (online); <https://www.overstock.com/Home-Garden/TV-Stand-for-TVs-up-to-60-inches/30841483/product.html?TID=PDP7o3ASimilarItemsCarousel%3Aclick&recalg=954%2C930&recidx=0&recset=0f33724c-aeb3-4523-8c14-9d784eb7cf87&refccid=GRRWJGIVNYNLCD2OLNIZIHD3SPQ>.

Ktaxon 58' Farmhouse TV Stand; Walmart.com; found online Apr. 21, 2021; retrieved May 4, 2021 (online); <https://www.walmart.com/ip/Ktaxon-58-Farmhouse-TV-Stand-TVs-60-Sliding-Wood-Barn-Door-Media-Console-Storage-Cabinet-Rustic-Gray-Wash-Entertainment-Center-Living-Room/671965194>.

Sekey Home Sliding Barn Door TV Stand; Walmart.com; found online Apr. 21, 2021; retrieved May 4, 2021 (online); <https://www.walmart.com/ip/Sekey-Home-Sliding-Barn-Door-TV-Stand-Entertainment-Center-TV-Console-for-58-for-Flat-Screen-TV-s-Up-to-65-Light-Oak/458659151>.

Wrangler Sliding Barn Door TV Stand; Walmart.com; found online Apr. 21, 2021; retrieved May 4, 2021 (online); <https://www.walmart.com/ip/pamari-tc54-6127-tpg03-wrangler-sliding-barn-door-tv-stand-off-white/232902955>.

UBesGoo Wooden TV Stand; Walmart.com; found online Apr. 21, 2021; retrieved May 5, 2021 (online) <https://www.walmart.com/ip/UBesGoo-Wooden-58-TV-Stand-for-TVs-up-to-60-with-Sliding-Wood-Barn-Door-Media-Console-Storage-Cabinet-for-Living-Room-Bedroom-Rustic-Gray-Wash/152098747>.

Walker Edison White Oak Sliding Barn Door Media Console; Walmart.com; found online Apr. 21, 2021; retrieved May 5, 2021 (online); [https://www.walmart.com/ip/58-inch-Sliding-Barn-Door-TV-Stand-Media-Console-in-White-Oak/207240611?wpa\\_bd=&wpa\\_pg\\_seller\\_id=203317B21FE947819EB684DAE150ECA5&wpa\\_ref\\_id=wpaqs:d\\_0rLoQQqieprA9uyaaVHYAZrOtC-Wq7We-HPBeJZ4x2Sw4GpnOlhz5qru9K6ySqAW-QcvE3KfQy194-h8-MvmpzeSFJim72C-yCvH20ltMjVOnstG23HBInTx63HkquiB05hGWHy8kVHOxlaFLkbyfv2FAVWjeQNq2bWhy9OQU8KSQFz6QkOVVSI45ek5NrhChuAbB5luyXKyBnz7mBFX5QNgoiDbJF\\_agFSWAaOWyLemcKJRpUROh3rkbe2KNnr4XI\\_but\\_fHWOGMo6IGSyxVrdkdPvJOExzLt4pA&wpa\\_tag=&wpa\\_aux\\_info=&wpa\\_pos=1&wpa\\_plmt=1145x1145\\_T-C-IG\\_TI\\_1\\_-2\\_HL-INGRID-GRID-NY&wpa\\_aduid=5766f3ab-d7ae-4319-80dd-6f96862cee51&wpa\\_pg=search&wpa\\_pg\\_id=sliding%20barn%20door%20tv%20stand&wpa\\_st=sliding%20barn%20door%20tv%20stand&wpa\\_tax=4044\\_103150\\_635499\\_2546222&wpa\\_bucket=\\_\\_bkt](https://www.walmart.com/ip/58-inch-Sliding-Barn-Door-TV-Stand-Media-Console-in-White-Oak/207240611?wpa_bd=&wpa_pg_seller_id=203317B21FE947819EB684DAE150ECA5&wpa_ref_id=wpaqs:d_0rLoQQqieprA9uyaaVHYAZrOtC-Wq7We-HPBeJZ4x2Sw4GpnOlhz5qru9K6ySqAW-QcvE3KfQy194-h8-MvmpzeSFJim72C-yCvH20ltMjVOnstG23HBInTx63HkquiB05hGWHy8kVHOxlaFLkbyfv2FAVWjeQNq2bWhy9OQU8KSQFz6QkOVVSI45ek5NrhChuAbB5luyXKyBnz7mBFX5QNgoiDbJF_agFSWAaOWyLemcKJRpUROh3rkbe2KNnr4XI_but_fHWOGMo6IGSyxVrdkdPvJOExzLt4pA&wpa_tag=&wpa_aux_info=&wpa_pos=1&wpa_plmt=1145x1145_T-C-IG_TI_1_-2_HL-INGRID-GRID-NY&wpa_aduid=5766f3ab-d7ae-4319-80dd-6f96862cee51&wpa_pg=search&wpa_pg_id=sliding%20barn%20door%20tv%20stand&wpa_st=sliding%20barn%20door%20tv%20stand&wpa_tax=4044_103150_635499_2546222&wpa_bucket=__bkt).

Albright TV Stand; Wayfair.com; found online Apr. 21, 2021; retrieved May 3, 2021 (online) <https://www.wayfair.com/furniture/pdp/three-posts-albright-tv-stand-w003419693.html?placement=1>.

Chantell TV Stand; Wayfair.com; found online Apr. 21, 2021; retrieved May 5, 2021 (online) <https://www.wayfair.com/furniture/pdp/latitude-run-chantell-tv-stand-for-tvs-up-to-65-lrun1015.html>.

Gainesboro TV Stand; Wayfair.com; found online Apr. 21, 2021; retrieved May 5, 2021 (online) <https://www.wayfair.com/furniture/pdp/winston-porter-gainesboro-tv-stand-for-tvs-up-to-65-w003895133.html>.

Albritton TV Stand; Wayfair.com; found online Apr. 21, 2021; retrieved May 5, 2021 (online) <https://www.wayfair.com/furniture/pdp/three-posts-albritton-tv-stand-for-tvs-up-to-65-w003404447.html?placement=1>.

Chabelli TV Stand; Wayfair.com; found online Apr. 21, 2021; retrieved May 5, 2021 (online) [https://www.wayfair.com/furniture/pdp/latitude-run-chabelli-tv-stand-for-tvs-up-to-65-w004029827.html?categoryid=1868409&placement=3&slot=5&sponsoredid=bb92fbde3cc952ed7e2c8269781\\_2cb88232c512191dad5893e80ad17d6adb05f&\\_txid=1%2FcMxF%2B1T41hnharBpMJAg%3D%3D&isB2b=0&auctionId=f9be48b1-0bcd-4aaf-b285-dbb3ea880db5](https://www.wayfair.com/furniture/pdp/latitude-run-chabelli-tv-stand-for-tvs-up-to-65-w004029827.html?categoryid=1868409&placement=3&slot=5&sponsoredid=bb92fbde3cc952ed7e2c8269781_2cb88232c512191dad5893e80ad17d6adb05f&_txid=1%2FcMxF%2B1T41hnharBpMJAg%3D%3D&isB2b=0&auctionId=f9be48b1-0bcd-4aaf-b285-dbb3ea880db5).

Gaither TV Stand; Wayfair.com; found online Apr. 21, 2021; retrieved May 5, 2021 (online) <https://www.wayfair.com/furniture/pdp/alcott-hill-gaither-tv-stand-for-tvs-up-to-65-with-fireplace-included-acot3821.html>.

Plazonja TV Stand; Wayfair.com; found online Apr. 21, 2021; retrieved May 5, 2021 (online) <https://www.wayfair.com/furniture/pdp/winston-porter-plazonja-tv-stand-for-tvs-up-to-75-w002590978.html>.

Alisée Console; Wayfair.com; found online Apr. 21, 2021; retrieved May 5, 2021 (online) <https://www.wayfair.com/furniture/pdp/ebern-designs-alisee-tv-stand-for-tvs-up-to-78-w002981803.html>.

Bolderberg Console; Wayfair.com; found online Apr. 21, 2021; retrieved May 5, 2021 (online) <https://www.wayfair.com/furniture/pdp/winston-porter-bolderberg-tv-stand-for-tvs-up-to-78-w003404204.html?placement=1>.

Dunsmuir TV Stand; Wayfair.com; found online Apr. 21, 2021; retrieved May 5, 2021 (online) <https://www.wayfair.com/furniture/pdp/andover-mills-dunsmuir-tv-stand-for-tvs-up-to-78-w002122263.html>.

Annaliece TV Stand; Wayfair.com; found online Apr. 21, 2021; retrieved May 5, 2021 (online) <https://www.wayfair.com/furniture/pdp/red-barrel-studio-annaliece-tv-stand-for-tvs-up-to-78-w004115724.html>.

Straughn TV Stand; Wayfair.com; found online Apr. 21, 2021; retrieved May 5, 2021 (online) <https://www.wayfair.com/furniture/pdp/gracie-oaks-straughn-tv-stand-for-tvs-up-to-78-w004455598.html>.

Strausstown TV Stand; Wayfair.com; found online Apr. 21, 2021; retrieved May 5, 2021 (online) <https://www.wayfair.com/furniture/pdp/gracie-oaks-strausstown-tv-stand-for-tvs-up-to-78-w004458013.html>.

Adcock TV Stand; Wayfair.com; found online Apr. 21, 2021; retrieved May 5, 2021 (online) <https://www.wayfair.com/furniture/pdp/andover-mills-adcock-tv-stand-for-tvs-up-to-78-w004124702.html?placement=7>.

Gaudreau TV Stand; Wayfair.com; found online Apr. 21, 2021; retrieved May 5, 2021 (online) <https://www.wayfair.com/furniture/pdp/red-barrel-studio-gaudreau-solid-wood-tv-stand-for-tvs-up-to-78-qdy2069.html>.

Himrod TV Stand; Wayfair.com; found online Apr. 21, 2021; retrieved May 5, 2021 (online) <https://www.wayfair.com/furniture/pdp/loon-peak-himrod-tv-stand-for-tvs-up-to-78-w004412411.html>.

Mouton TV Stand; Wayfair.com; found online Apr. 21, 2021; retrieved May 5, 2021 (online) <https://www.wayfair.com/furniture/pdp/foundry-select-mouton-tv-stand-for-tvs-up-to-78-w001812510.html>.

Humphery TV Stand; Google Search; Wayfair.com; found online Apr. 21, 2021 retrieved May 10, 2021 (online); <https://www.hickoryfurniture.com/itembrowser.aspx?action=attributes&itemtype=furniture&event=reset&wsearch=bridgeport>.

Vigue TV Stand; Wayfair.com; found online Apr. 21, 2021; retrieved May 5, 2021 (online) <https://www.wayfair.com/furniture/pdp/foundry-select-vigue-tv-stand-for-tvs-up-to-78-w002881900.html>.

Gorete TV Stand; Wayfair.com; found online Apr. 21, 2021; retrieved May 5, 2021 (online) <https://www.wayfair.com/furniture/pdp/latitude-run-gorete-tv-stand-for-tvs-up-to-78-w004589072.html>.



(56)

## References Cited

## OTHER PUBLICATIONS

Alcott Hill TV Stand with Fireplace; Wayfair.com; found online Apr. 21, 2021; retrieved May 5, 2021 (online); <https://www.wayfair.com/furniture/pdp/alcott-hill-santa-tv-stand-for-tvs-up-to-70-with-fireplace-included-w001442995.html?piid=1644522337>.

West Elm Website “furniture” search; Westelm.com; retrieved Apr. 20, 2020 (online) [https://www.westelm.com/shop/furniture/?searchredir=true&cm\\_sp=HeaderLinks-\\_-OnsiteSearch-\\_-MainSite&cm\\_type=OnsiteSearch&term=furniture&searchredirtype=br](https://www.westelm.com/shop/furniture/?searchredir=true&cm_sp=HeaderLinks-_-OnsiteSearch-_-MainSite&cm_type=OnsiteSearch&term=furniture&searchredirtype=br).

Raymour Flanigan Website “Living Rooms” search; raymourflanigan.com; retrieved Nov. 6, 2020 (online); <https://raymourflanigan.com/living-rooms>.

Crate and Barrel Website “Business Interior Design” search; crateandbarrel.com Retrieved Nov. 6, 2020 (online); [https://www.crateandbarrel.com/trade-program/?a=784&campaignid=1061902950&adgroupid=55881134521&targetid=aud-1097585102856:kwd-415008832538&adpos=&creative=251673559670&device=c&matchtype=e&network=g&gclid=Cj0KCQjwytOEBhD5ARIsANnRjVgCRKameP5yMquG6rsNP7KAU-nUpzG5NfgZU-PhRCRUgz507littMaAhvLEALw\\_wcB](https://www.crateandbarrel.com/trade-program/?a=784&campaignid=1061902950&adgroupid=55881134521&targetid=aud-1097585102856:kwd-415008832538&adpos=&creative=251673559670&device=c&matchtype=e&network=g&gclid=Cj0KCQjwytOEBhD5ARIsANnRjVgCRKameP5yMquG6rsNP7KAU-nUpzG5NfgZU-PhRCRUgz507littMaAhvLEALw_wcB).

Crate and Barrel Website “Business Office Design” search; crateandbarrel.com; retrieved Nov. 6, 2020 (online); <https://www.crateandbarrel.ca/trade-program/>.

Penny Mustard Website “Bridgeport” search; pennymustard.com; retrieved May 13, 2020 (online) <https://www.pennymustard.com/search.inc?q=bridgeport&p=1>.

Home Living Furniture Website “coaster furniture, bridgeport, servers” search; homelivingfurniture.com retrieved May 13, 2020 (online); [https://www.homelivingfurniture.com/st/\\_t\\_/105525](https://www.homelivingfurniture.com/st/_t_/105525).

Whitley Furniture Website “dining room, gat-creek, curio cabinets, bridgeport” search whitleygalleries.com; retrieved May 13, 2020 (online); <https://www.whitleygalleries.com/gat-creek-bridgeport-four-door-cabinet/81593-1137/iteminformation.aspx>.

Oak Finish 70-Inch TV Stand, <https://www.inspireq.com/products/oak-finish-tv-stand-e976ak-t>, retrieved Jun. 2, 2021.

Grey Wash Finish TV Stand, <https://www.inspireq.com/collections/living-room/products/grey-wash-finish-tv-stand-with-door-e975gat>, retrieved Jun. 2, 2021.

Matte Black Finish Metal Coat Rack with Ladder Shelf, <https://www.inspireq.com/collections/home-decor/products/matte-black-finish-metal-coat-rack-with-ladder-shelf-e824bk>, retrieved Jun. 2, 2021.

Sadie Low Bookshelf, [https://www.homethreads.com/products/furniture/tv-stands/sadie-low-bookshelf-oak?gclid=CjwKCAjwJ2FBhAuEiwAIKu1903PBxz3p9PodtUUqKh6fPJHibPGIulJBjNuddyHp8BBTK412S1BoCgOoQAvD\\_BwE](https://www.homethreads.com/products/furniture/tv-stands/sadie-low-bookshelf-oak?gclid=CjwKCAjwJ2FBhAuEiwAIKu1903PBxz3p9PodtUUqKh6fPJHibPGIulJBjNuddyHp8BBTK412S1BoCgOoQAvD_BwE), retrieved Jun. 2, 2021, available on information and believe as early as Aug. 2013.

Ameriwood Home Farmington Electric Fireplace TV Console for TVs up to 60", Rustic, [https://www.amazon.com/Ameriwood-Home-Farmington-Electric-Fireplace/dp/B01JADOQ52/ref=dp\\_prsubs\\_1?pd\\_rd\\_i=B01JADOQ52&pvc=1](https://www.amazon.com/Ameriwood-Home-Farmington-Electric-Fireplace/dp/B01JADOQ52/ref=dp_prsubs_1?pd_rd_i=B01JADOQ52&pvc=1), retrieved Jun. 2, 2021, available on information and believe as early as Jul. 2016.

Farmington 60 in. Century Barn Pine Wood TV Stand with 2 Drawer Fits TVs Up to 60 in. with Storage Doors, [https://www.homedepot.com/pep/Altra-Furniture-Farmington-60-in-Century-Barn-Pine-Wood-TV-Stand-with-2-Drawer-Fits-TVs-Up-to-60-in-with-Storage-Doors-1783215PCOM/300318849?source=shoppingads&locale=en-US&mtc=Shopping-BA-F\\_HDH-G-D59-59\\_34\\_INTERIOR\\_FURNITURE-MULTI-NA-Feed-PLA-NA-NA-059\\_034\\_006\\_HOME\\_ENTERTAINMENT\\_FURN\\_Home\\_Entertainment&cm\\_mmc=Shopping-BA-F-HDH-G-D59-59\\_34\\_INTERIOR\\_FURNITURE-MULTI-NA-Feed-PLA-NA-NA-059\\_034\\_006\\_Home\\_Entertainment\\_Furn\\_Home\\_Entertainment-7170000051494672-58700004993904823-92700061190272430&gclid=CjwKCAjwJ2FBhAuEiwAIKu19pVm9Q\\_uSEY88TOeOkNfZ8IAfWHtpcxTuqczP5-EYfeixW15etjLxoCh\\_QQAvD\\_BwE&gclid=aw.ds](https://www.homedepot.com/pep/Altra-Furniture-Farmington-60-in-Century-Barn-Pine-Wood-TV-Stand-with-2-Drawer-Fits-TVs-Up-to-60-in-with-Storage-Doors-1783215PCOM/300318849?source=shoppingads&locale=en-US&mtc=Shopping-BA-F_HDH-G-D59-59_34_INTERIOR_FURNITURE-MULTI-NA-Feed-PLA-NA-NA-059_034_006_HOME_ENTERTAINMENT_FURN_Home_Entertainment&cm_mmc=Shopping-BA-F-HDH-G-D59-59_34_INTERIOR_FURNITURE-MULTI-NA-Feed-PLA-NA-NA-059_034_006_Home_Entertainment_Furn_Home_Entertainment-7170000051494672-58700004993904823-92700061190272430&gclid=CjwKCAjwJ2FBhAuEiwAIKu19pVm9Q_uSEY88TOeOkNfZ8IAfWHtpcxTuqczP5-EYfeixW15etjLxoCh_QQAvD_BwE&gclid=aw.ds), retrieved Jun. 2, 2021, available on information and believe as early as Dec. 2015.

DIY Media Console—Free Plans, <https://www.shanty-2-chic.com/2015/07/diy-media-console-free-plans.html>, retrieved Jun. 2, 2021, available on information and believe as early as Jul. 2015.

DIY Barn Door Media Console, <https://www.shanty-2-chic.com/2014/06/diy-barn-door-media-console.html>, retrieved Jun. 2, 2021, available on information and believe as early as Jun. 2014.

Joss & Main TV Stand, available on information and believe as early as Jul. 2015.

Rogue Engineer, DIY Rustic Media Center, <https://rogueengineer.com/diy-rustic-media-center-plans/>, retrieved Jun. 2, 2021, available on information and believe as early as Jul. 2015.

Ameriwood Home Bloomfield Natural/Heritage Light Pine TV Stand, <https://www.lowes.com/pd/Ameriwood-Home-Bloomfield-TV-Stand-for-TVs-up-to-60-in-Natural/1003087852>, retrieved Jun. 2, 2021.

Custom 9-Foot Rustic Buffet, <https://www.pinterest.com/pin/40250990400157640/>, retrieved Jun. 2, 2021, available on information and believe as early as Jan. 2017.

Sauder Dakota Pass Credenza, [https://US.amazon.com/dp/B01GK8VWPC/ref=sbl\\_dp\\_x\\_B07LGGGCFQ\\_0](https://US.amazon.com/dp/B01GK8VWPC/ref=sbl_dp_x_B07LGGGCFQ_0), retrieved Jun. 2, 2021, available on information and believe as early as Mar. 2016.

Aspen Antique Red 64" TV Stand, <https://www.sancarlosimports.com/asanredtvst.html>, retrieved Jun. 2, 2021, available on information and believe as early as Dec. 2015.

San Carlos Imports Santiago TV Stand, available on information and believe as early as Dec. 2015.

San Carlos Imports San Felipe TV Stand, available on information and believe as early as Dec. 2015.

Aspen Antique Multi Color 76" TV Stand, <https://www.pinterest.com/pin/315040936427682950/>, retrieved Jun. 2, 2021, available on information and believe as early as Dec. 2015.

San Carlos 65" Rustic TV Stand with Cross, <https://www.sancarlosimports.com/rustic-tv-stand-cross.html>, retrieved Jun. 2, 2021, available on information and believe as early as Dec. 2015.

Laredo Rustic 60" TV Stand, <https://www.pinterest.com/pin/37295503137850917/>, retrieved Jun. 2, 2021, available on information and believe as early as Dec. 2015.

San Carlos 48" TV Stand, <https://www.sancarlosimports.com/sanca48rutvs.html>, retrieved Jun. 2, 2021, available on information and believe as early as Dec. 2015.

Mountain Modern Cabinet, available on information and believe as early as Oct. 2015.

Safavieh American Homes Collection Sadie Low Bookshelf, Oak, retrieved from <https://www.amazon.com/Safavieh-AMH6525C-American-Collection-Bookshelf/dp/B00MMBHHVK> on Jun. 3, 2021.

Safavieh American Homes Collection Sadie Off White Low Bookshelf, found online on May 12, 2021 at [https://www.amazon.com/dp/B004LGP9FO/ref=cm\\_sw\\_su\\_dp?tag=50kud003-20&th=1](https://www.amazon.com/dp/B004LGP9FO/ref=cm_sw_su_dp?tag=50kud003-20&th=1), retrieved Jun. 3, 2021.

Safavieh Sadie Low Bookshelf, found online at <https://web.archive.org/web/20150327201221/https://safavieh.com/furniture/bookcases/amh6525c>, retrieved Jun. 3, 2021, available on information and belief as early as Mar. 27, 2015.

Safavieh Sadie Country Nautical Low Bookshelf, found online on May 10, 2021 at <https://www.walmart.com/ip/Safavieh-Sadie-Country-Nautical-Low-Bookshelf/37549808?selected=true>, retrieved Jun. 3, 2021.

UHURU Furniture & Collectibles Long Low Wooden Bookcase, found online at <https://uhurufurniture.blogspot.com/2011/08/long-low-wooden-bookcase-90.html>, retrieved Jun. 3, 2021, available on information and belief as early as Aug. 17, 2011.

Woven Paths Open Storage TV Stand for TVs up to 80", Espresso, found online on May 10, 2021 at <https://www.walmart.com/ip/Woven-Paths-Open-Storage-TV-Stand-for-TVs-up-to-80-Espresso/411955245>, retrieved Jun. 3, 2021.

Notice of Allowance for U.S. Appl. No. 29/699,063; dated Jun. 17, 2021.

Notice of Allowance for U.S. Appl. No. 29/698,919; dated Jun. 23, 2021.

Office Action for U.S. Appl. No. 29/756,302; dated Jul. 12, 2021.

“Pemberly Row Farmhouse Mesh Sliding Barn Door 32-inch Wood Home Coffee Station.” Found online Jun. 30, 2021 at [www.amazon.com](http://www.amazon.com).



(56)

## References Cited

## OTHER PUBLICATIONS

com. Product first available Dec. 28, 2018. Retrieved from URL <https://tinyurl.com/2h79ybk5> (Year: 2018).

“Home Square 2 Piece Farmhouse Mesh Barn Door TV Stand.” Found online Jun. 30, 2021 at [www.amazon.com](http://www.amazon.com). Product first available Dec. 6, 2019. Retrieved from URL <https://www.amazon.com/Home-Square-Farmhouse-Console-Cabinet/dp/B082DZ5J83?th=1> (Year 2019).

“The Gray Barn Kujawa Sliding Mesh Door Console.” Found online Jun. 30, 2021 at [www.overstock.com](http://www.overstock.com). Product reviewed May 11, 2020. Retrieved from URL: <https://tinyurl.com/24ttxchw> (Year: 2020).

“SSLLine 32-inch Farmhouse Accent Storage Cabinet.” Found online Jun. 30, 2021 at [www.amazon.com](http://www.amazon.com). Product first available Jul. 20, 2020. Retrieved from URL <https://www.amazon.com/dp/B0915LKX3W/?tag=abnd-20&th=1> (Year: 2020).

“Rustic Cabinet Barn Door Console.” Found online Jun. 30, 2021 at [www.ebay.com](http://www.ebay.com). Page dated Sep. 5, 2020. Retrieved from URL: <https://www.ebay.com/itm/313181659463> (Year: 2020).

“handbird Display Cabinet.” Found online Jun. 30, 2021 at [www.kmart.com](http://www.kmart.com). Product first available Jan. 29, 2021. Retrieved from URL: <https://www.kmart.com/handbird-display-cabinet-tv-stand-w-sliding-barn/p-A093830443> (Year: 2021).

Ex Parte Quayle Office Action for U.S. Appl. No. 29/756,303; dated Jul. 12, 2021.

“Walker Edison Weston Modern Farmhouse Sliding Glass Door Storage Console.” Found online Jun. 30, 2021 at [www.amazon.com](http://www.amazon.com). Product reviewed Mar. 26, 2019. Retrieved from URL <https://tinyurl.com/3vnkj5z7> (Year: 2019).

“Manor Park 32 Sliding Glass Door Accent Cabinet.” Found online Jun. 30, 2021 at [www.walmart.com](http://www.walmart.com). Product reviewed Jul. 17, 2020. Retrieved from URL: <https://www.walmart.com/ip/Manor-Park-32-Sliding-Glass-Door-Accent-Cabinet-Solid-White/927438446?selected=true> (Year: 2020).

Notice of Allowance for U.S. Appl. No. 29/756,305; dated Jul. 16, 2021.

Notice of Allowance for U.S. Appl. No. 29/756,291; dated Jul. 14, 2021.

Notice of Allowance for U.S. Appl. No. 29/756,763; dated Jul. 23, 2021.

Sha Cerlin 52" Farmhouse TV Stand with Sliding Barn Door, retrieved from [https://www.amazon.com/SHA-CERLIN-Farmhouse-Adjustable-Entertainment/dp/B094JWM1QF/ref=sr\\_1\\_21?dchild=1&m=A2YBITOQ3E0O2T&marketplaceID=ATVPDKIKXODER&qid=1626471396&s=merchant-items&sr=1-21](https://www.amazon.com/SHA-CERLIN-Farmhouse-Adjustable-Entertainment/dp/B094JWM1QF/ref=sr_1_21?dchild=1&m=A2YBITOQ3E0O2T&marketplaceID=ATVPDKIKXODER&qid=1626471396&s=merchant-items&sr=1-21), available on information and belief as of May 10, 2021; retrieved on Aug. 18, 2021. Sha Cerlin TV Stand, retrieved from [https://www.amazon.com/SHA-CERLIN-Farmhouse-Entertainment-Adjustable/dp/B094SWDB8J/ref=sr\\_1\\_63?dchild=1&keywords=sha+cerlin&qid=1626467539&s=home-garden&sr=1-63](https://www.amazon.com/SHA-CERLIN-Farmhouse-Entertainment-Adjustable/dp/B094SWDB8J/ref=sr_1_63?dchild=1&keywords=sha+cerlin&qid=1626467539&s=home-garden&sr=1-63), available on information and belief as of May 13, 2021; retrieved on Aug. 18, 2021.

Restriction Requirement for U.S. Appl. No. 29/743,423; dated Sep. 7, 2021.

Restriction Requirement for U.S. Appl. No. 29/743,237; dated Sep. 7, 2021.

Walker Edison Willa Modern Farmhouse Sliding Single Slat Door Storage Console. Found online Jun. 30, 2021 at [www.amazon.com](http://www.amazon.com). Product reviewed Jun. 18, 2019. Retrieved from URL <https://tinyurl.com/4n3s9x45> (Year: 2019).

Woven Paths 32-inch Sliding Slat Door Accent Cabinet. Found online Jun. 30, 2021 at [www.walmart.com](http://www.walmart.com). Product reviewed Sep. 14, 2019. Retrieved from URL: <https://tinyurl.com/2bsjztvy> (Year: 2019).

“HOM ECHO Farmhouse Storage Cabinet.” Found online Jun. 30, 2021 at [www.amazon.com](http://www.amazon.com). Product first available Oct. 7, 2020. Retrieved from URL: <https://tinyurl.com/9f2yj8ks> (Year: 2020).

“HOMCOM Rustic Farmhouse Accent Side Cabinet.” Found online Jun. 30, 2021 at [www.amazon.com](http://www.amazon.com). Product first available Jan. 20, 2021. Retrieved from URL: <https://tinyurl.com/ntzeu7ey> (Year: 2021).

Office Action for U.S. Appl. No. 29/743,244; dated Sep. 10, 2021.

“Carson Carrington Esbo 48-inch Corner TV Stand Console” Jun. 29, 2020, [overstock.com](http://overstock.com), site visited Sep. 7, 2021 <<https://www.overstock.com/Home-Garden/Carson-Carrington-Esbo-48-2-Door-Glass-Shelf-Corner-TV-Console/30270125/product.html>> (Year: 2020).

Office Action for U.S. Appl. No. 29/743,250; dated Sep. 14, 2021.

Office Action for U.S. Appl. No. 29/743,584; dated Sep. 14, 2021.

Office Action for U.S. Appl. No. 29/743,247; dated Sep. 15, 2021.

Notice of Allowance for U.S. Appl. No. 29/743,240; dated Sep. 15, 2021.

Restriction Requirement for U.S. Appl. No. 29/743,246; dated Sep. 14, 2021.

Notice of Allowance for U.S. Appl. No. 29/743,418; dated Sep. 20, 2021.

Sauder Saddler Way TV Stand for TVs up to 68", Lintel Oak Finish, retrieved from <https://www.walmart.com/ip/Sauder-Saddler-Way-TV-Stand-for-TVs-up-to-65-Intel-Oak-Finish/522898196> on Sep. 23, 2021.

Sauder Adept Storage Accent Storage Cabinet, For TV's up to 39", Craftsman Oak finish, retrieved from [https://www.amazon.com/Sauder-Adept-Storage-Cabinet-Craftsman/dp/B076FBWJV3/ref=cm\\_cr\\_ar\\_p\\_d\\_product\\_top?ie=UTF8](https://www.amazon.com/Sauder-Adept-Storage-Cabinet-Craftsman/dp/B076FBWJV3/ref=cm_cr_ar_p_d_product_top?ie=UTF8) on Sep. 23, 2021.

Sauder Dakota Pass Entertainment/Fireplace Credenza, For TV's up to 60", Craftsman Oak finish, Retrieved from [https://www.amazon.com/Sauder-419119-Entertainment-Fireplace-Craftsman/dp/B016QM1NIK/ref=cm\\_cr\\_ar\\_p\\_d\\_product\\_top?ie=UTF8](https://www.amazon.com/Sauder-419119-Entertainment-Fireplace-Craftsman/dp/B016QM1NIK/ref=cm_cr_ar_p_d_product_top?ie=UTF8) on Sep. 23, 2021.

Fireplace TV Credenza with Glass Doors, retrieved from <https://www.sauder.com/furniture/427377/fireplace-tv-credenza-with-glass-doors> on Sep. 23, 2021.

Sauder Barrister Lane Media Fireplace, for TVs up to 60", Salt Oak finish, retrieved from [https://www.amazon.com/Sauder-Barrister-Fireplace-Entertainment-Accommodates/dp/B07GC88LRN/ref=cm\\_cr\\_ar\\_p\\_d\\_product\\_top?ie=UTF8](https://www.amazon.com/Sauder-Barrister-Fireplace-Entertainment-Accommodates/dp/B07GC88LRN/ref=cm_cr_ar_p_d_product_top?ie=UTF8) on Sep. 23, 2021.

JAXPETY 58" Wooden TV Stand with Glass Door for 65" TVs Farmhouse Style Media Console Storage Cabinet Entertainment Center for Living Room, retrieved from <https://www.sears.com/jaxpety-58inch-wooden-tv-stand-w-glass-door/p-A105951271> on Sep. 28, 2021.

Jaxpety 58" Farmhouse Barn Door TV Stand for TVs up to 65", Wooden Media Console Storage Cabinet for Living Room, Bedroom, Brown Oak, retrieved from <https://www.walmart.com/ip/Jaxpety-58-Farmhouse-Barn-Door-TV-Stand-for-TVs-up-to-65-Wooden-Media-Console-Storage-Cabinet-for-Living-Room-Bedroom-Brown-Oak/314330068> on Sep. 28, 2021.

Notice of Allowance for U.S. Appl. No. 29/756,303; dated Oct. 1, 2021.

Office Action for U.S. Appl. No. 29/773,569; dated Oct. 6, 2021.

“Walker Edison Beaumont.” Found online Sep. 13, 2021 at [www.amazon.com](http://www.amazon.com). Product first available Nov. 8, 2018. Retrieved from URL [https://www.amazon.com/dp/B07K9F9YGF/ref=fb\\_l\\_dp\\_x\\_B092VPQV67\\_0](https://www.amazon.com/dp/B07K9F9YGF/ref=fb_l_dp_x_B092VPQV67_0) (Year: 2018).

“Woven Paths Modern Farmhouse Sliding Door Accent.” Found online Sep. 13, 2021 at [www.walmart.com](http://www.walmart.com). Product reviewed Jan. 19, 2019. Retrieved from URL <https://www.walmart.com/ip/Woven-Paths-Modern-Farmhouse-Sliding-Door-Accent-Cabinet-Stone-Grey/418425379> (Year: 2019).

“Sauder Adept Storage Accent Storage Cabinet.” Found online Sep. 13, 2021 at [www.amazon.com](http://www.amazon.com). Product first available Oct. 30, 2017. Retrieved from URL: <https://tinyurl.com/2e7tnx7d> (Year: 2017).

Notice of Allowance for U.S. Appl. No. 29/756,302; dated Oct. 27, 2021.

Office Action for U.S. Appl. No. 29/756,305; dated Nov. 15, 2021.

Notice of Allowance for U.S. Appl. No. 29/743,240; dated Nov. 24, 2021.

Notice of Allowance for U.S. Appl. No. 29/743,418; dated Nov. 24, 2021.

“LuxenHome 3 Piece White Wood Bathroom Furniture Set” <https://www.homesquare.com/LuxenHome-3-Piece-White-Wood-Bathroom-Furniture-Set-2397532-PKG.htm> Found online Nov. 12, 2021; Retrieved on Dec. 2, 2021.

“Luxen Home Wood Farmhouse Storage Cabinet” <https://shopping.yahoo.com/product/00810000777488/Luxen-Home-Wood-Farmhouse->



(56)

## References Cited

## OTHER PUBLICATIONS

Storage-Cabinet?pid=skimlinks\_310-10477784&gucounter=1 Found online Nov. 12, 2021; Retrieved on Dec. 2, 2021.

“Luxen Home Rustic Chic Sliding Door Wood Cabinet” [https://shopping.yahoo.com/product/00810000772858/Luxen-Home-Rustic-Chic-Sliding-Door-Wood-Cabinet?pid=skimlinks\\_310-9997530](https://shopping.yahoo.com/product/00810000772858/Luxen-Home-Rustic-Chic-Sliding-Door-Wood-Cabinet?pid=skimlinks_310-9997530) Found online Nov. 12, 2021; Retrieved on Dec. 2, 2021.

“LuxenHome Sliding Door White Wood Wall Cabinet” <https://www.cymax.com/Sliding-Door-White-Wood-Wall-Cabinet-WHIF1248.htm> Found online Nov. 12, 2021; Retrieved on Dec. 2, 2021.

“LuxenHöme Natural Oak Finish Wine Bar Cabinet with 2 Drawers, Wood Storage Sideboard with Slide Door, Corner Coffee Table with 2-Layer Storage Shelf for Dining Room Kitchen, 32 inch, Oak Color” [https://www.amazon.com/LuxenH%C3%B6me-Natural-Cabinet-Drawers-Sideboard/dp/B097TTJMMT?ref=ast\\_sto\\_dp&th=1](https://www.amazon.com/LuxenH%C3%B6me-Natural-Cabinet-Drawers-Sideboard/dp/B097TTJMMT?ref=ast_sto_dp&th=1) Found online Nov. 12, 2021; Retrieved on Dec. 2, 2021.

“LuxenHöme Weathered Wood Storage Single Barn Door Wall Cabinet, Farmhouse Wall Storage with Shelves Inside, Kitchen Wall Cabinet for Daily use, 22 Inch, Disdressed Wood” [https://www.amazon.com/LuxenH%C3%B6me-Weathered-Storage-Farmhouse-Disdressed/dp/B09GL3WNL9/ref=sr\\_1\\_51?dchild=1&m=ADLW6LFOJCOSW&marketplaceID=ATVPDKIKXODER&qid=1633737779&s=merchant-items&sr=1-51&th=1](https://www.amazon.com/LuxenH%C3%B6me-Weathered-Storage-Farmhouse-Disdressed/dp/B09GL3WNL9/ref=sr_1_51?dchild=1&m=ADLW6LFOJCOSW&marketplaceID=ATVPDKIKXODER&qid=1633737779&s=merchant-items&sr=1-51&th=1) Found online Nov. 12, 2021; Retrieved on Dec. 2, 2021.

“LuxenHöme Pallet Sliding Door Wood Storage Cabinet, Modern Farmhouse Sliding Single Slat Door Storage Console, Coffee Table with Shelves Inside for Kitchen Living Room Bedroom, 32 inch, White/Brown” <https://www.amazon.com/Luxen-Pallet-Sliding-Storage-Cabinet/dp/B08PDV42M3?th=1> Found online Nov. 12, 2021; Retrieved on Dec. 2, 2021.

“WAMPAT Farmhouse Sliding Barn Door Accent Cabinet Buffet Entryway Bar Storage Table for Living Room, Bathroom and Home Kitchen, 35 Inch, White” <https://www.ubuy.co.id/en/product/INJGSUT4-wampat-farmhouse-sliding-barn-door-accent-cabinet-buffet-entryway-bar-storage-table-for-living-room> Found online Nov. 12, 2021; Retrieved on Dec. 2, 2021.

“BELIFEGORY Barn Door Storage Cabinet, Farmhouse Sliding Barn Door Wood Accent Chest Kitchen Buffet Cabinet with Adjustable Shelves for Entryway Bar Home Office (Grey)” <https://www.ubuy.co.id/en/product/ZFHQSXO-belifegory-barn-door-storage-cabinet-farmhouse-sliding-barn-door-wood-accent-chest-kitchen-buffet-c> Found online Nov. 12, 2021; Retrieved on Dec. 2, 2021.

“Luxen Home Bathroom Wall Storage Cabinet” [https://shopping.yahoo.com/product/00810000773121/Luxen-Home-Bathroom-Wall-Storage-Cabinet?pid=skimlinks\\_310-9997549](https://shopping.yahoo.com/product/00810000773121/Luxen-Home-Bathroom-Wall-Storage-Cabinet?pid=skimlinks_310-9997549) Found online Nov. 12, 2021; Retrieved on Dec. 2, 2021.

“Yosef Entertainment Center for TVs up to 55” <https://www.wayfair.com/furniture/pdp/yosef-entertainment-center-for-tvs-up-to-55-w005296062.html> Found online Nov. 12, 2021; Retrieved on Dec. 2, 2021.

“Saugeen TV Stand for TVs up to 64” <https://www.wayfair.com/furniture/pdp/gracie-oaks-saugeen-tv-stand-for-tvs-up-to-64-w003546807.html> Found online Nov. 12, 2021; Retrieved on Dec. 2, 2021.

“Mcglathin TV Stand For TVs Up To 70” <https://cyewayinc.com/collections/tv-stand/products/mcglathin-tv-stand-for-tvs-up-to-70?variant=40149957247139> Found online Nov. 12, 2021; Retrieved on Dec. 2, 2021.

“Concordia TV Stand for TVs up to 65" with Fireplace Included” <https://www.wayfair.com/furniture/pdp/gracie-oaks-concordia-tv-stand-for-tvs-up-to-65-with-fireplace-included-w004032688.html> Found online Nov. 12, 2021; Retrieved on Dec. 2, 2021.

“Uli 48" Solid Wood Kitchen Island” <https://www.wayfair.com/furniture/pdp/gracie-oaks-uli-kitchen-island-oak-butcher-block-top-grks7182.html> Found online Nov. 12, 2021; Retrieved on Dec. 2, 2021.

“Alayziah 52" Wide Buffet Table” <https://www.wayfair.com/furniture/pdp/gracie-oaks-alayziah-52-wide-buffet-table-w003233776.html> Found online Nov. 12, 2021; Retrieved on Dec. 2, 2021.

“Swedish Hill TV Stand for TVs up to 88" with Fireplace Included” <https://www.wayfair.com/furniture/pdp/gracie-oaks-swedish-hill-tv-stand-for-tvs-up-to-88-with-electric-fireplace-included-w000339756.html> Found online Nov. 12, 2021; Retrieved on Dec. 2, 2021.

“Clematite TV Stand for TVs up to 65” <https://www.wayfair.com/furniture/pdp/gracie-oaks-clematite-tv-stand-for-tvs-up-to-65-w003025551.html> Found online Nov. 12, 2021; Retrieved on Dec. 2, 2021.

“Arti TV Stand for TVs up to 65” <https://www.wayfair.com/furniture/pdp/gracie-oaks-arti-tv-stand-for-tvs-up-to-65-w004646275.html> Found online Nov. 12, 2021; Retrieved on Dec. 2, 2021.

“Garden City TV Stand for TVs up to 65” <https://www.wayfair.com/furniture/pdp/gracie-oaks-garden-city-tv-stand-for-tvs-up-to-65-w002818215.html> Found online Nov. 12, 2021; Retrieved on Dec. 2, 2021.

“Seabeck TV Stand for TVs up to 55" with Fireplace Included” <https://www.wayfair.com/furniture/pdp/gracie-oaks-seabeck-w004878945.html> Found online Nov. 12, 2021 Retrieved on Dec. 2, 2021.

“Theobald End Table” <https://www.wayfair.com/furniture/pdp/gracie-oaks-theobald-end-table-with-storage-w005274882.html> Found online Nov. 12, 2021; Retrieved on Dec. 2, 2021.

“Rossitano Solid Wood End Table” <https://www.wayfair.com/furniture/pdp/gracie-oaks-rossitano-end-table-hlds6279.html> Found online Nov. 12, 2021; Retrieved on Dec. 2, 2021.

“Berneau 30.7" Wide Sideboard” <https://www.wayfair.com/furniture/pdp/gracie-oaks-berneau-307-wide-sideboard-w003399479.html> Found online Nov. 12, 2021; Retrieved on Dec. 2, 2021.

“FurnitureR 32 Inch Sideboard Open Storage Cabinet with Sliding Door, 2 Shelves for Kitchen & Dining Furniture,Manufactured Wood” <https://www.amazon.com/FurnitureR-Sideboard-Storage-Furniture-Manufactured/dp/B097PFWYDT> Found online Nov. 12, 2021; Retrieved on Dec. 2, 2021.

“1—Door Accent Cabinet” <https://www.wayfair.com/furniture/pdp/39f-inc-newbarn-cabinet-tnfi2607.html> Found online Nov. 12, 21; Retrieved on Dec. 2, 2021.

“Newbarn TV Stand” <https://www.homylin.com/products/newbarn-tv-stand> Found online Nov. 12, 21 Retrieved on Dec. 2, 2021.

“32" Farmhouse Sliding Barn Door Storage Cabinet ,Wood Accent Cabinet Kitchen Buffet Cabinet With Adjustable Shelves White” <https://www.walmart.com/ip/Farmhouse-Sliding-Barn-Storage-Cabinet/306453208> Found online Nov. 12, 2021; Retrieved on Dec. 2, 2021.

“TV Stand with Barn Door, 2 Open Compartments, Cable Management, TV Table for TVs up to 57 Inches” <https://www.walmart.com/ip/TV-Stand-with-Barn-Door-2-Open-Compartments-Cable-Management-TV-Table-for-TVs-up-to-57-Inches/935482009> Found online Nov. 12, 2021; Retrieved on Dec. 2, 2021.

“TV Stand with Barn Door, 2 Open Compartments, Cable Management, TV Table for TVs up to 57 Inches Grey” <https://www.walmart.com/ip/TV-Stand-with-Barn-Door-2-Open-Compartments-Cable-Management-TV-Table-for-TVs-up-to-57-Inches-Grey/379595098> Found online Nov. 12, 2021; Retrieved on Dec. 2, 2021.

Office Action for U.S. Appl. No. 29/743,423; dated Dec. 3, 2021.

Office Action for U.S. Appl. No. 29/743,246; dated Dec. 6, 2021.

Notice of Allowance for U.S. Appl. No. 29/743,237; dated Dec. 13, 2021.

DIY Media Center / Buffet With Barn Doors; “Against the Grain” video <https://www.youtube.com/watch?v=IOF-uZeuoXE> ; Found online on Dec. 14, 2021.

Ana White, Grandy Barn Door Console; “How to build barn door console or buffet—free plans by Ana-White.com” <http://www.ana-white.com/woodworking-projects/grandy-barn-door-console> ; Found online on Dec. 14, 2021; Retrieved on Dec. 17, 2021.

Notice of Allowance for U.S. Appl. No. 29/743,244; dated Jan. 5, 2022.

Notice of Allowance for U.S. Appl. No. 29/743,247; dated Jan. 5, 2022.

Notice of Allowance for U.S. Appl. No. 29/743,250; dated Jan. 20, 2022.



(56)

**References Cited**

OTHER PUBLICATIONS

Notice of Allowance for U.S. Appl. No. 29/743,584 dated Jan. 20, 2022.

\* cited by examiner



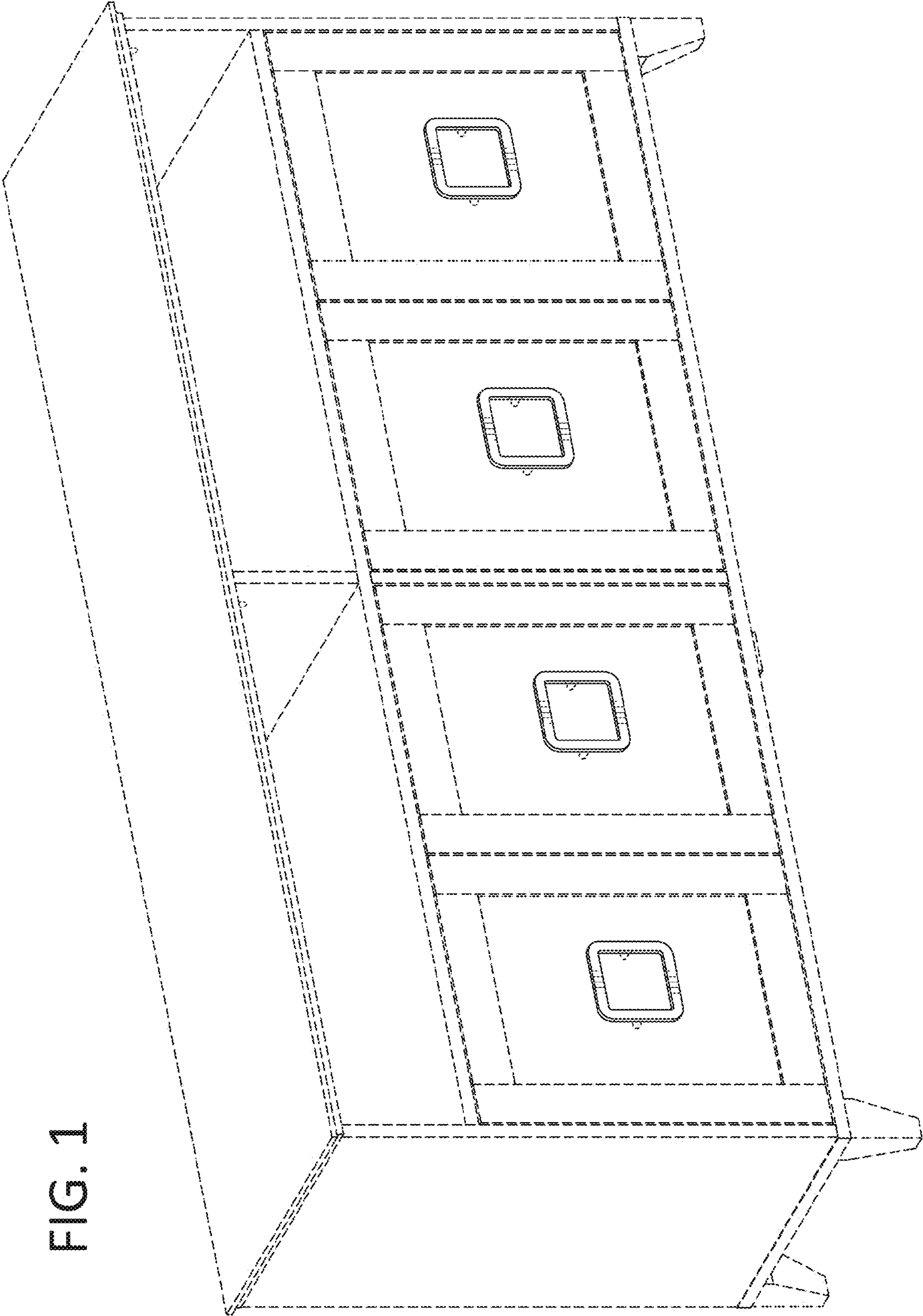

FIG. 1



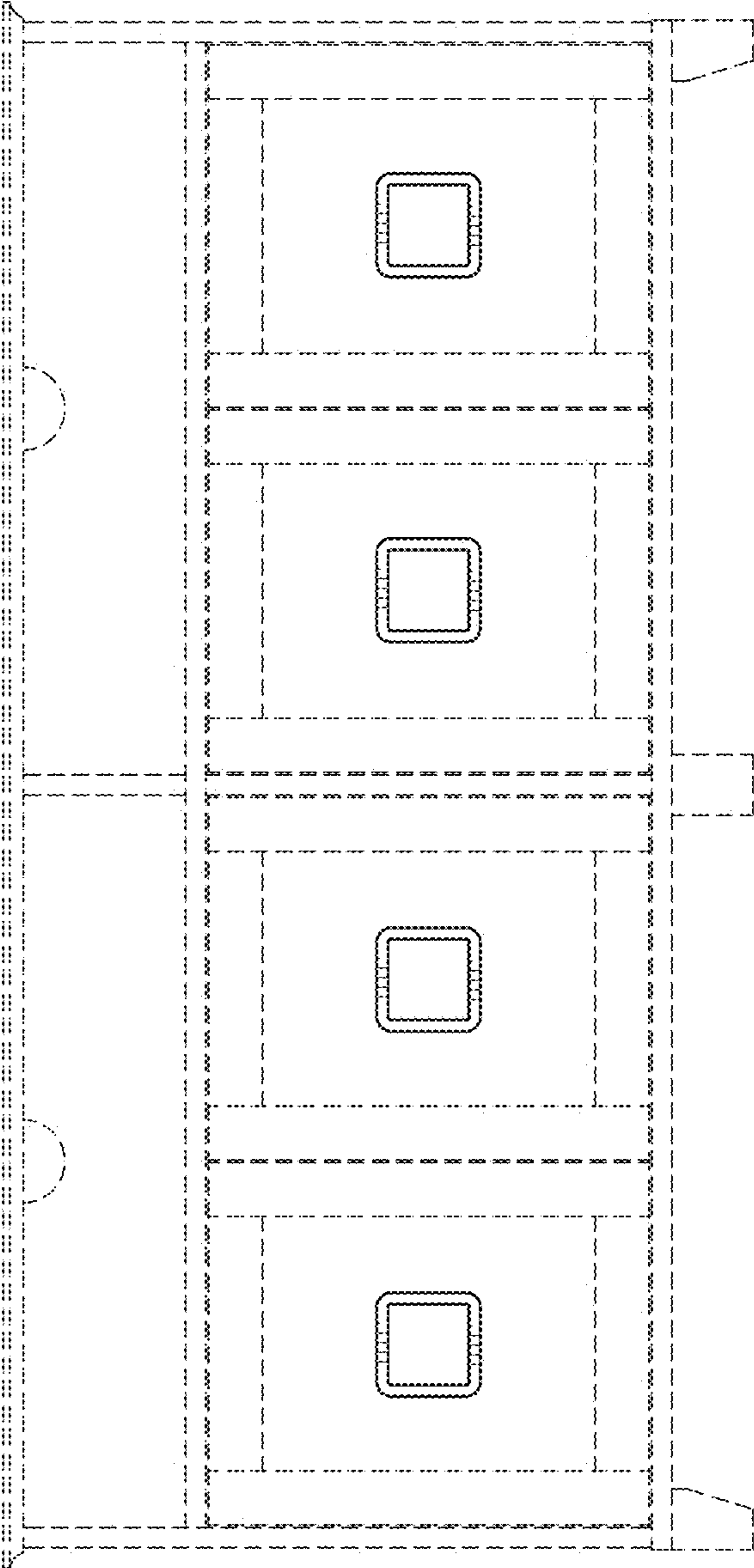

FIG. 2

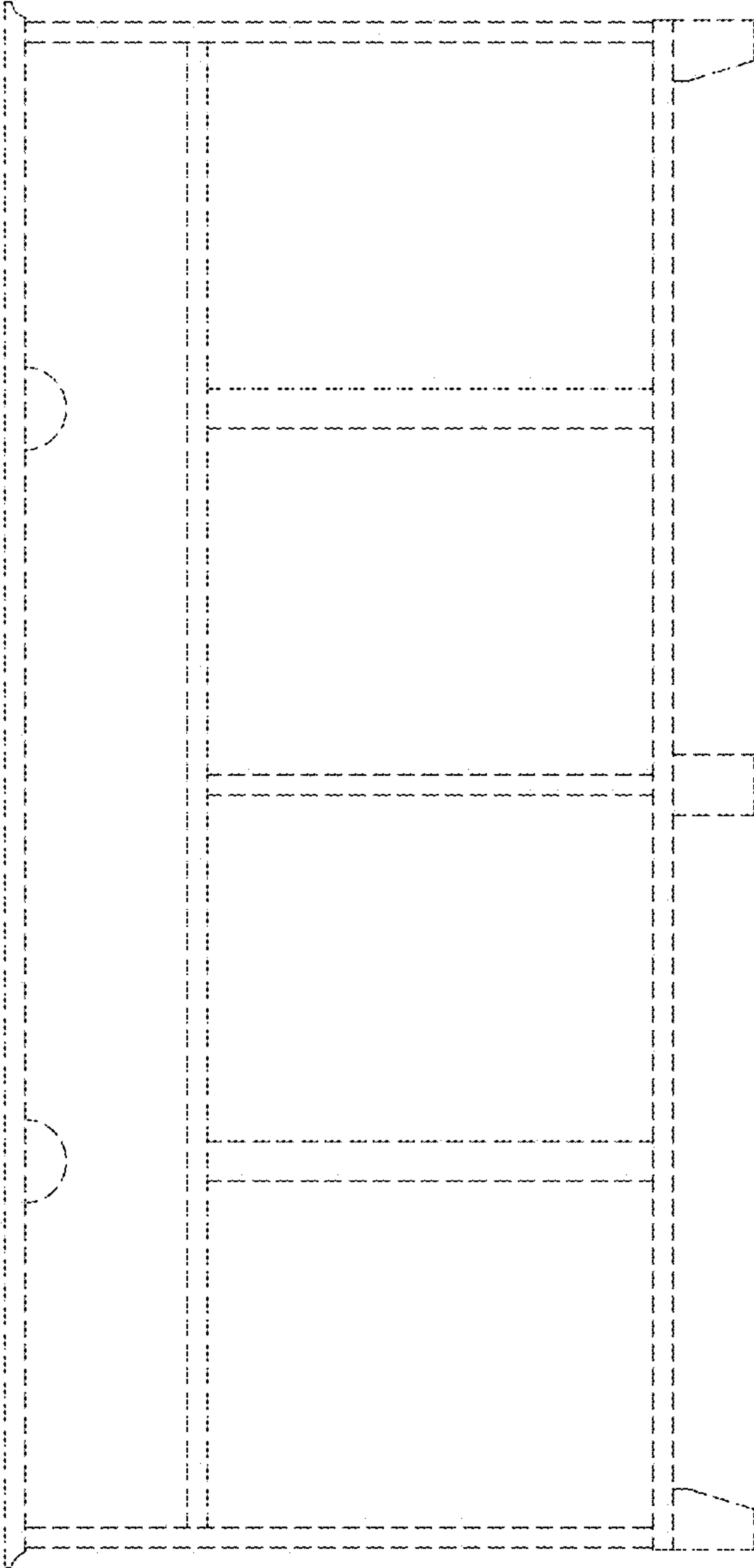

FIG. 3



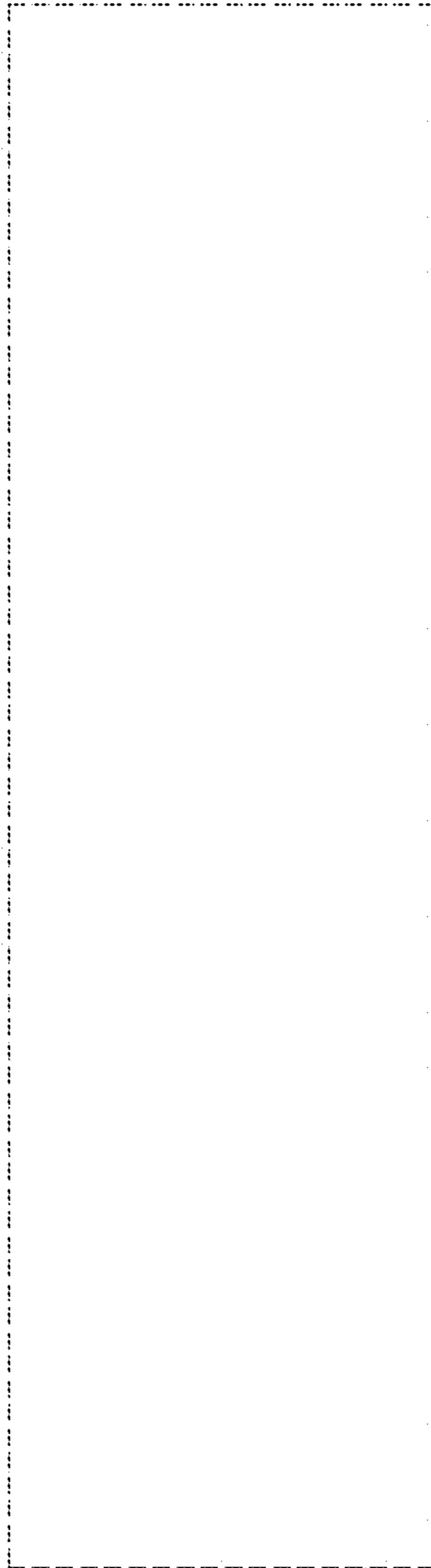

FIG. 4

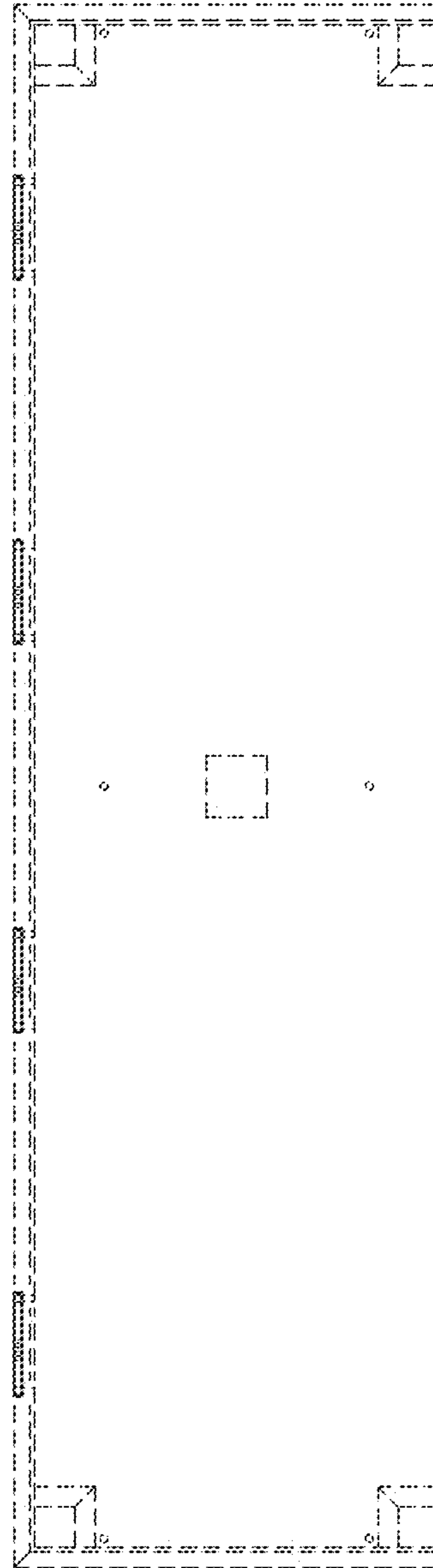

FIG. 5



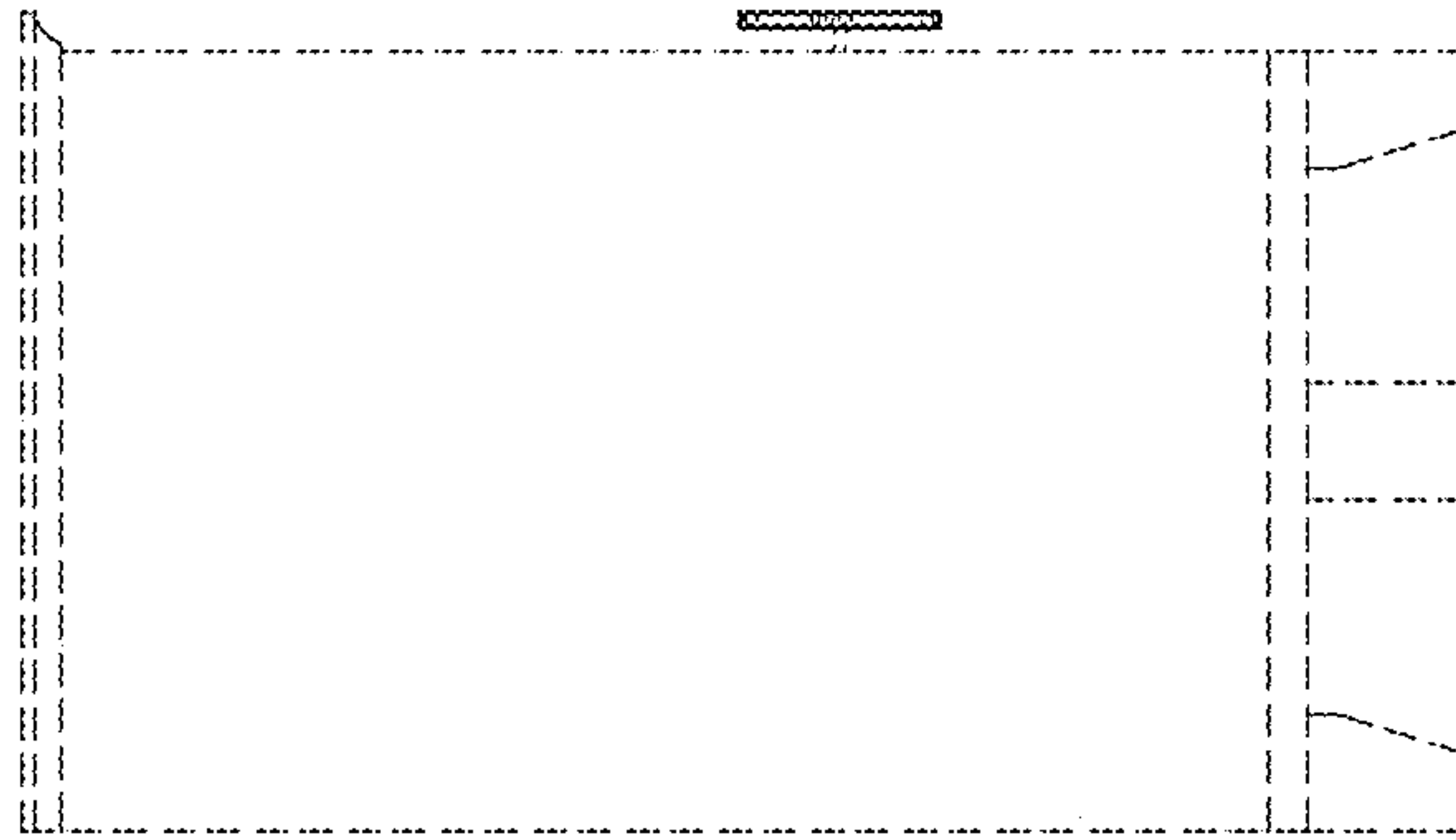

FIG. 7

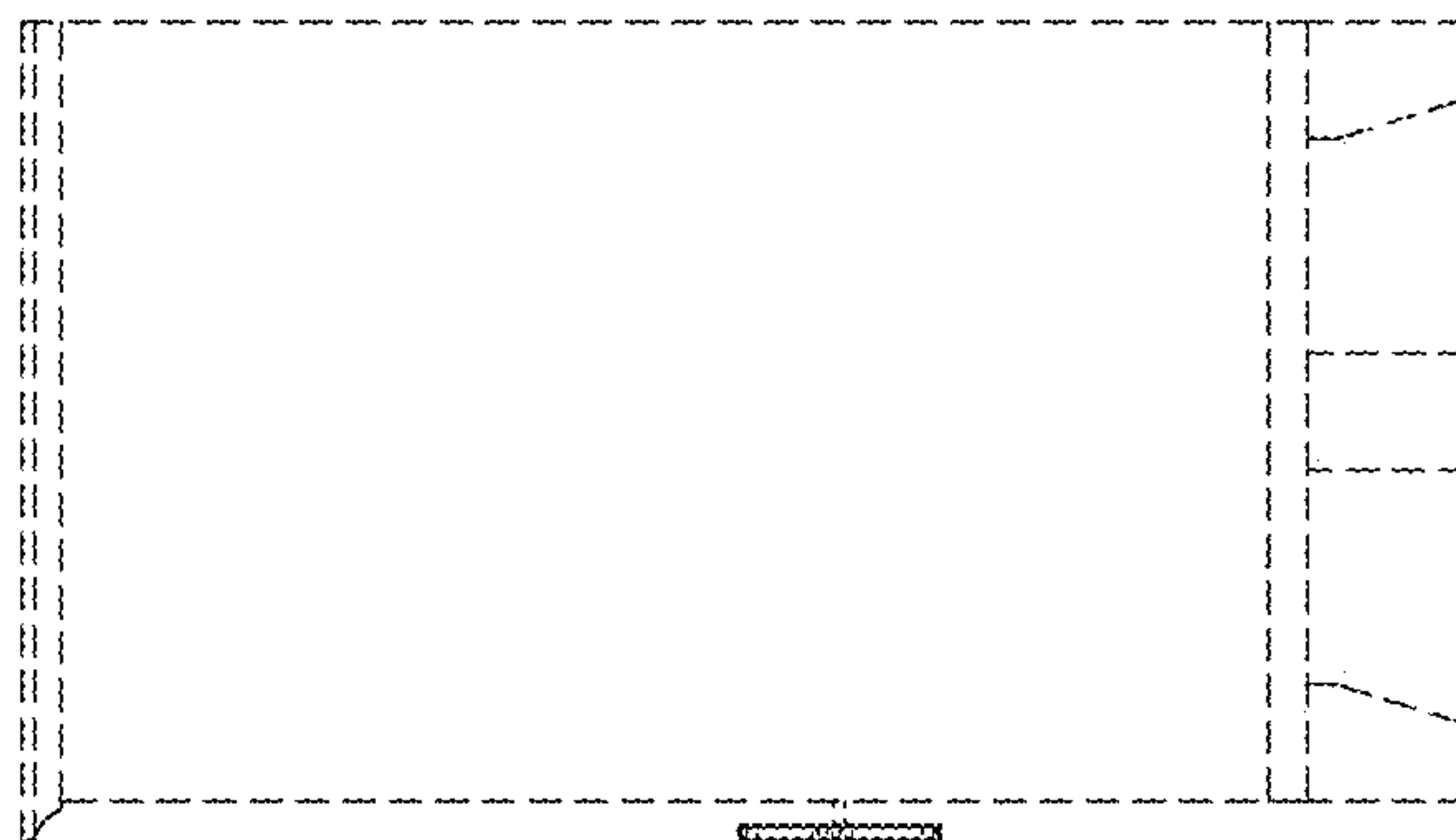

FIG. 6