



(12) **United States Design Patent** (10) **Patent No.:** **US D947,565 S**
Starkey (45) **Date of Patent:** **** Apr. 5, 2022**

(54) **ROLL TOWEL DISPENSER ROLLER TAB**

FOREIGN PATENT DOCUMENTS

(71) Applicant: **Bradley Fixtures Corporation**,
Menomonee Falls, WI (US)

CN 111802949 A 10/2020
EP 3 721 771 A1 10/2020

(Continued)

(72) Inventor: **Michael M. Starkey**, Kent, OH (US)

OTHER PUBLICATIONS

(73) Assignee: **Bradley Fixtures Corporation**,
Menomonee Falls, WI (US)

International Search Report and Written Opinion regarding corresponding PCT Application No. PCT/US2018/033319, dated Oct. 25, 2018, 13 pps.

(**) Term: **15 Years**

(Continued)

(21) Appl. No.: **29/695,329**

Primary Examiner — Nathan M Johnston

(22) Filed: **Jun. 18, 2019**

(74) *Attorney, Agent, or Firm* — Foley & Lardner LLP

Related U.S. Application Data

(63) Continuation of application No. 29/647,878, filed on May 16, 2018, now Pat. No. Des. 854,347.

(57) **CLAIM**

(51) **LOC (13) Cl.** **20-02**

I claim the ornamental design for a roll towel dispenser roller tab, as shown and described.

(52) **U.S. Cl.**

USPC **D6/518**

(58) **Field of Classification Search**

USPC D6/515–518, 553, 542–545, 567, 574;
206/225, 233, 389, 391, 77.1; 211/13.1,
211/173, 180, 45, 86.01, 87.02, 87.01;
248/309.1, 309.2, 905; 242/570, 590;
221/26.33, 282, 283, 14, 92, 105;
222/173, 180, 281–282

DESCRIPTION

CPC ... A47K 10/40; A47K 10/38; A47K 2010/324
See application file for complete search history.

This application is related to U.S. Des. Pat. App. Ser. No. 29/647,869, filed on May 16, 2018, entitled “housing for a roll towel dispenser,” which is also incorporated herein by reference in its entirety.

FIG. 1 is a top perspective view of a roll towel dispenser roller tab showing my new design;

FIG. 2 is a front side view of the claimed design of FIG. 1;

FIG. 3 is a rear side view of the claimed design of FIG. 1;

FIG. 4 is a right side view of the claimed design of FIG. 1;

FIG. 5 is a left side view of the claimed design of FIG. 1;

FIG. 6 is a top view of the claimed design of FIG. 1; and,

FIG. 7 is a bottom view of the claimed design of FIG. 1.

The ornamental design which is claimed is shown in solid lines in the drawings.

(56) **References Cited**

U.S. PATENT DOCUMENTS

2,144,070 A 1/1939 Witt
3,145,940 A 8/1964 Henry
3,322,359 A 5/1967 Dales
3,459,353 A 8/1969 Taylor
3,730,409 A 5/1973 Ratti

(Continued)

1 Claim, 5 Drawing Sheets

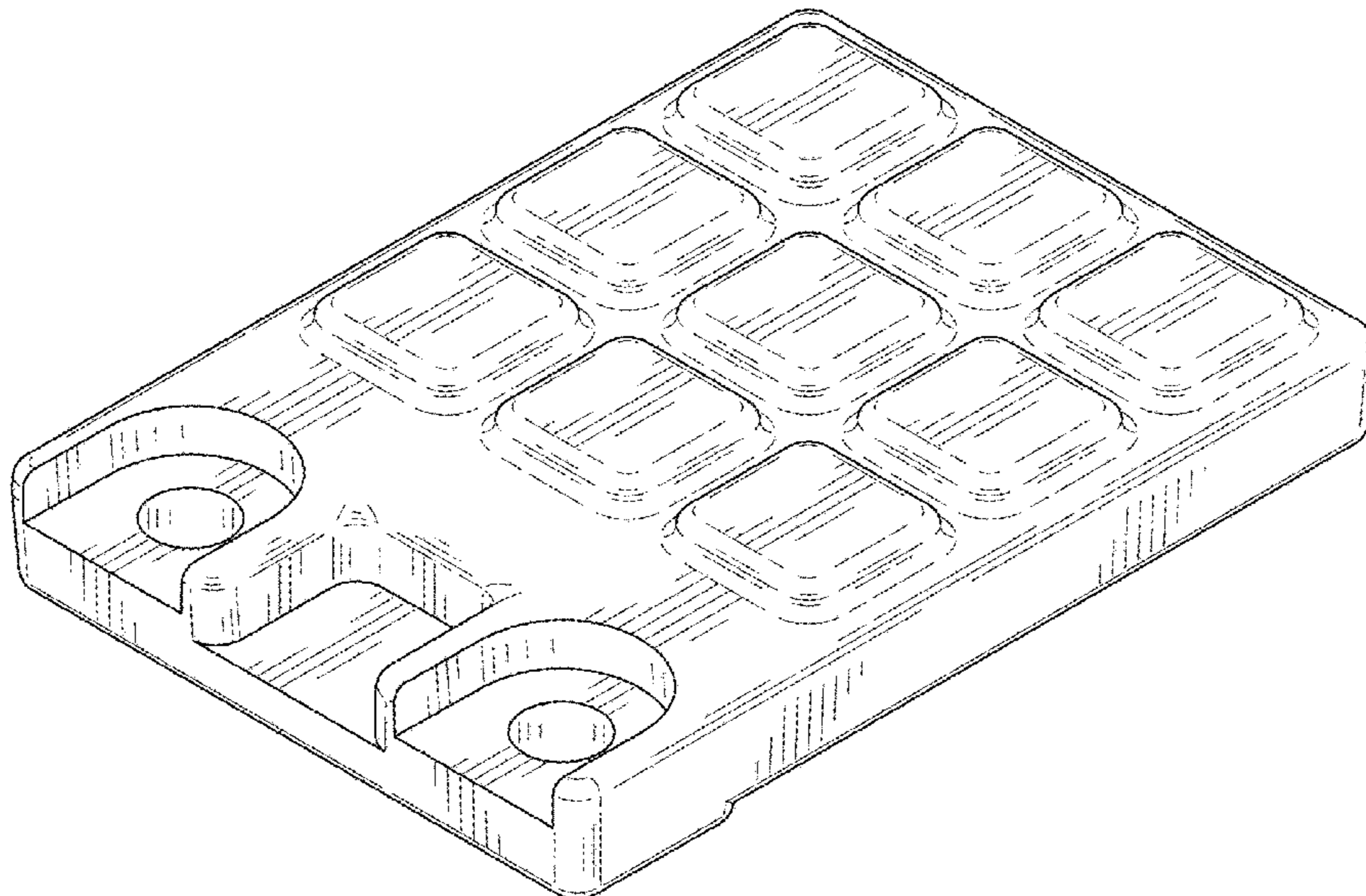

(56)

References Cited

U.S. PATENT DOCUMENTS

4,106,684 A	8/1978	Hartbauer et al.	D610,486 S *	2/2010	Yoshie	D11/221
4,298,122 A	11/1981	Ekelund	7,698,980 B2	4/2010	Morris et al.	
4,688,751 A	8/1987	Valot	7,783,380 B2	8/2010	York et al.	
4,721,265 A	1/1988	Hawkins	D623,452 S	9/2010	McNeely et al.	
4,807,824 A	2/1989	Gains et al.	7,793,882 B2	9/2010	Reinsel et al.	
D303,610 S	9/1989	Mastandrea	7,878,446 B2	2/2011	Reinsel et al.	
D303,886 S	10/1989	Reid	7,896,196 B2	3/2011	Wegelin et al.	
D308,244 S *	5/1990	Leonakis	7,905,444 B2	3/2011	Chen	
D312,369 S	11/1990	De Luca et al.	7,931,228 B2	4/2011	Omdoll	
D325,486 S	4/1992	Goldstein	D638,805 S *	5/2011	Clymer	D13/168
D343,973 S	2/1994	Mele	7,984,872 B2	7/2011	Kuehneman et al.	
5,294,192 A	3/1994	Omdoll et al.	7,987,756 B2	8/2011	Lewis et al.	
5,375,785 A	12/1994	Boone et al.	7,996,108 B2	8/2011	Yardley	
D359,959 S *	7/1995	Scianna, Sr.	D644,468 S	9/2011	Hansen	
5,452,832 A	9/1995	Niada	D654,741 S	2/2012	Hansen	
D368,487 S *	4/1996	Lindberg	8,113,483 B2	2/2012	Bayley et al.	
D373,998 S *	9/1996	Tutt	D656,348 S	3/2012	Velazquez et al.	
5,558,302 A	9/1996	Jespersion	D657,984 S	4/2012	Hansen	
5,588,627 A	12/1996	Sharpe	8,162,252 B2	4/2012	Cittadino et al.	
5,623,880 A	4/1997	Kuntz	D658,481 S	5/2012	Pratt	
5,651,384 A	7/1997	Rudrich	8,186,551 B2	5/2012	Morris et al.	
5,669,576 A	9/1997	Moody	8,224,480 B2	7/2012	Mok et al.	
5,924,617 A	7/1999	Lacount et al.	D664,796 S	8/2012	Cattacin et al.	
5,979,822 A	11/1999	Morand et al.	D666,038 S	8/2012	Wilkins et al.	
6,056,234 A	5/2000	Kim	D668,484 S	10/2012	Velazquez et al.	
6,069,354 A	5/2000	Alfano et al.	8,297,160 B2	10/2012	Friesen et al.	
D430,999 S	9/2000	Lodi	D674,223 S	1/2013	Green et al.	
6,145,783 A	11/2000	Kim	8,382,026 B2	2/2013	Keily et al.	
6,224,010 B1	5/2001	Morand	D682,795 S *	5/2013	McDonald	D13/168
D444,050 S	6/2001	Wyers	D687,651 S	8/2013	Niada	
D447,656 S	9/2001	Richter	8,528,851 B2	9/2013	Friesen et al.	
D450,689 S *	11/2001	Langford	D699,048 S	2/2014	Paal et al.	
6,314,850 B1	11/2001	Morand	D699,470 S	2/2014	Pasquini	
6,321,963 B1	11/2001	Gracyalny et al.	8,684,297 B2	4/2014	Moody et al.	
6,411,920 B1	6/2002	McConnell et al.	8,777,149 B2	7/2014	Goeking et al.	
6,419,136 B2	7/2002	Formon et al.	8,789,787 B2	7/2014	Kling et al.	
6,460,798 B1	10/2002	Haen et al.	8,796,624 B2	8/2014	Mok et al.	
6,499,684 B2	12/2002	Eaton et al.	8,807,475 B2	8/2014	Rodrian et al.	
D475,610 S	6/2003	Rehkemper et al.	8,882,021 B2	11/2014	Cittadino et al.	
6,592,067 B2	7/2003	Denen et al.	8,919,688 B2	12/2014	Kuehneman et al.	
6,695,246 B1	2/2004	Elliott et al.	8,960,588 B2	2/2015	Byrd et al.	
6,736,348 B1	5/2004	Formon et al.	9,027,871 B2	5/2015	Kuehneman et al.	
6,820,785 B2	11/2004	Kapiloff	9,066,639 B2	6/2015	Hagleitner	
6,826,985 B2	12/2004	Broehl	9,068,326 B2	6/2015	Chen et al.	
6,854,684 B2	2/2005	Byrd et al.	9,144,352 B2	9/2015	Cittadino et al.	
6,892,620 B2	5/2005	Kapiloff	9,167,941 B2	10/2015	Cittadino et al.	
D509,690 S	9/2005	Wolpert et al.	9,248,988 B2	2/2016	Keily et al.	
6,977,588 B2	12/2005	Schotz et al.	9,345,367 B2	5/2016	Keily et al.	
D515,566 S	2/2006	Hwang	9,370,283 B2	6/2016	Fellhoelter	
D515,899 S	2/2006	Chan	D764,469 S *	8/2016	Kaliauer	D14/399
7,017,856 B2	3/2006	Moody et al.	D766,241 S *	9/2016	Maletz	D14/399
D518,350 S	4/2006	Hay	9,446,924 B2	9/2016	Omdoll	
D526,546 S	8/2006	Jirele et al.	D769,016 S	10/2016	Achton	
7,084,592 B2	8/2006	Rodrian	D773,202 S	12/2016	Madsen et al.	
7,182,288 B2	2/2007	Denen et al.	9,524,604 B2	12/2016	Erb	
7,182,289 B2	2/2007	Moody et al.	D779,909 S *	2/2017	Sheppard	D8/307
D538,274 S *	3/2007	Gray	D784,334 S *	4/2017	Tehranchi	D14/383
7,213,782 B2	5/2007	Osborne et al.	D787,295 S *	5/2017	Young	D8/307
7,237,744 B2	7/2007	Morris et al.	9,635,986 B2	5/2017	Phelps	
D549,710 S *	8/2007	Hynecek	9,645,561 B2	5/2017	Borke et al.	
D553,402 S	10/2007	Orgna et al.	D789,111 S	6/2017	Terrill et al.	
7,296,765 B2	11/2007	Rodrian	D792,122 S	7/2017	Hagleitner	
7,325,768 B2	2/2008	Byrd et al.	D792,357 S *	7/2017	Tehranchi	D13/164
7,327,744 B2	2/2008	Agrawal et al.	9,701,508 B2	7/2017	Diamond	
7,354,015 B2	4/2008	Byrd et al.	D795,607 S	8/2017	Gottschalk	
D568,655 S	5/2008	Friesen et al.	9,770,143 B2	9/2017	Corley et al.	
D570,856 S *	6/2008	Forester	9,918,597 B2	3/2018	Rubenson et al.	
7,387,274 B2	6/2008	Moody et al.	D821,406 S *	6/2018	Turksu	D14/455
7,398,944 B2	7/2008	Lewis et al.	9,999,326 B2	6/2018	Borke et al.	
D574,816 S *	8/2008	Tang	10,123,666 B2	11/2018	Ruthven et al.	
7,416,152 B2	8/2008	Wieser et al.	10,159,389 B2	12/2018	Goeking et al.	
D582,242 S	12/2008	Bryan	D839,021 S	1/2019	Green	
D588,074 S *	3/2009	Hollner	D840,710 S	2/2019	Hagleitner	
7,523,885 B2	4/2009	Lewis	10,213,068 B2	2/2019	Diamond	
7,594,622 B2	9/2009	Witt et al.	D843,129 S	3/2019	Hagleitner	
			10,238,245 B2	3/2019	Rubenson et al.	
			D848,421 S *	5/2019	Turksu	D14/399
			10,299,638 B2	5/2019	Henson et al.	
			10,441,117 B2	10/2019	Osborne, Jr.	

(56)

References Cited

U.S. PATENT DOCUMENTS

10,485,388 B1 11/2019 McIntosh
 10,517,443 B2 12/2019 Diamond
 D874,461 S * 2/2020 Siminoff D14/399
 10,610,064 B2 4/2020 Osborne et al.
 10,660,485 B2 5/2020 Johnson et al.
 10,660,486 B2 5/2020 Osborne, Jr.
 D886,656 S * 6/2020 Zaidi D10/106.95
 10,694,900 B2 6/2020 Troutman et al.
 D899,890 S * 10/2020 Eads D8/308
 10,791,884 B2 10/2020 Starkey et al.
 10,835,086 B2 11/2020 Osborne, Jr.
 10,898,035 B2 1/2021 McIntosh
 D922,982 S * 6/2021 Wang D14/218
 D923,625 S * 6/2021 Siminoff D14/399
 2002/0073821 A1 6/2002 Broehl
 2002/0134881 A1 9/2002 Hoernig
 2003/0110915 A1 6/2003 Kapiloff et al.
 2006/0102769 A1 5/2006 Wieser et al.
 2007/0176041 A1 8/2007 Friesen et al.
 2008/0048064 A1 2/2008 Lemaire et al.
 2009/0302727 A1 12/2009 Vincent et al.
 2010/0243696 A1 9/2010 Friesen et al.
 2010/0286818 A1 11/2010 Goeking et al.
 2010/0314429 A1 12/2010 Troutman et al.
 2011/0068215 A1 3/2011 Troutman et al.
 2011/0163056 A1 7/2011 Domenig et al.
 2011/0210198 A1 9/2011 Case et al.
 2012/0097789 A1 4/2012 Benedetti
 2012/0097790 A1 4/2012 Wilkins et al.
 2012/0286087 A1 11/2012 Alvarez Tapia et al.
 2012/0312853 A1 12/2012 Osborne et al.
 2013/0043266 A1 2/2013 Hagleitner
 2013/0119183 A1 5/2013 Cattacin et al.
 2013/0248644 A1 9/2013 Goeking et al.

2014/0217117 A1 8/2014 Mirbach
 2014/0263703 A1 9/2014 Waitlevertch et al.
 2015/0217932 A1 8/2015 Carmen
 2015/0289730 A1 10/2015 Keily et al.
 2015/0305578 A1 10/2015 Keily et al.
 2015/0374181 A1 12/2015 Morand
 2016/0331192 A1 11/2016 Rubenson et al.
 2016/0353946 A1 12/2016 Osborne, Jr.
 2016/0353947 A1 12/2016 Osborne, Jr.
 2017/0042390 A1 2/2017 Rubenson et al.
 2017/0042391 A1 2/2017 Morand
 2017/0188760 A1 7/2017 Henson et al.
 2017/0290471 A1 10/2017 Borke et al.
 2018/0033313 A1 2/2018 Mellema et al.
 2018/0177348 A1 6/2018 Swanson et al.
 2018/0263434 A1 9/2018 Babikian et al.
 2018/0333013 A1 11/2018 Starkey et al.
 2019/0014956 A1 1/2019 Chang
 2019/0274490 A1 9/2019 Trampolski
 2020/0029750 A1 1/2020 Zimmermann et al.
 2020/0029752 A1 1/2020 Zimmermann et al.
 2020/0054177 A1 2/2020 Osborne, Jr.
 2020/0205620 A1 7/2020 Osborne, Jr.
 2020/0205621 A1 7/2020 Osborne, Jr.

FOREIGN PATENT DOCUMENTS

WO WO-2016/154512 A1 9/2016
 WO WO-2016/204924 12/2016

OTHER PUBLICATIONS

Invitation to Pay Additional Fees, Search Report and Written Opinion regarding PCT/US2019/032451 dated Aug. 16, 2019, 15 pps.

* cited by examiner

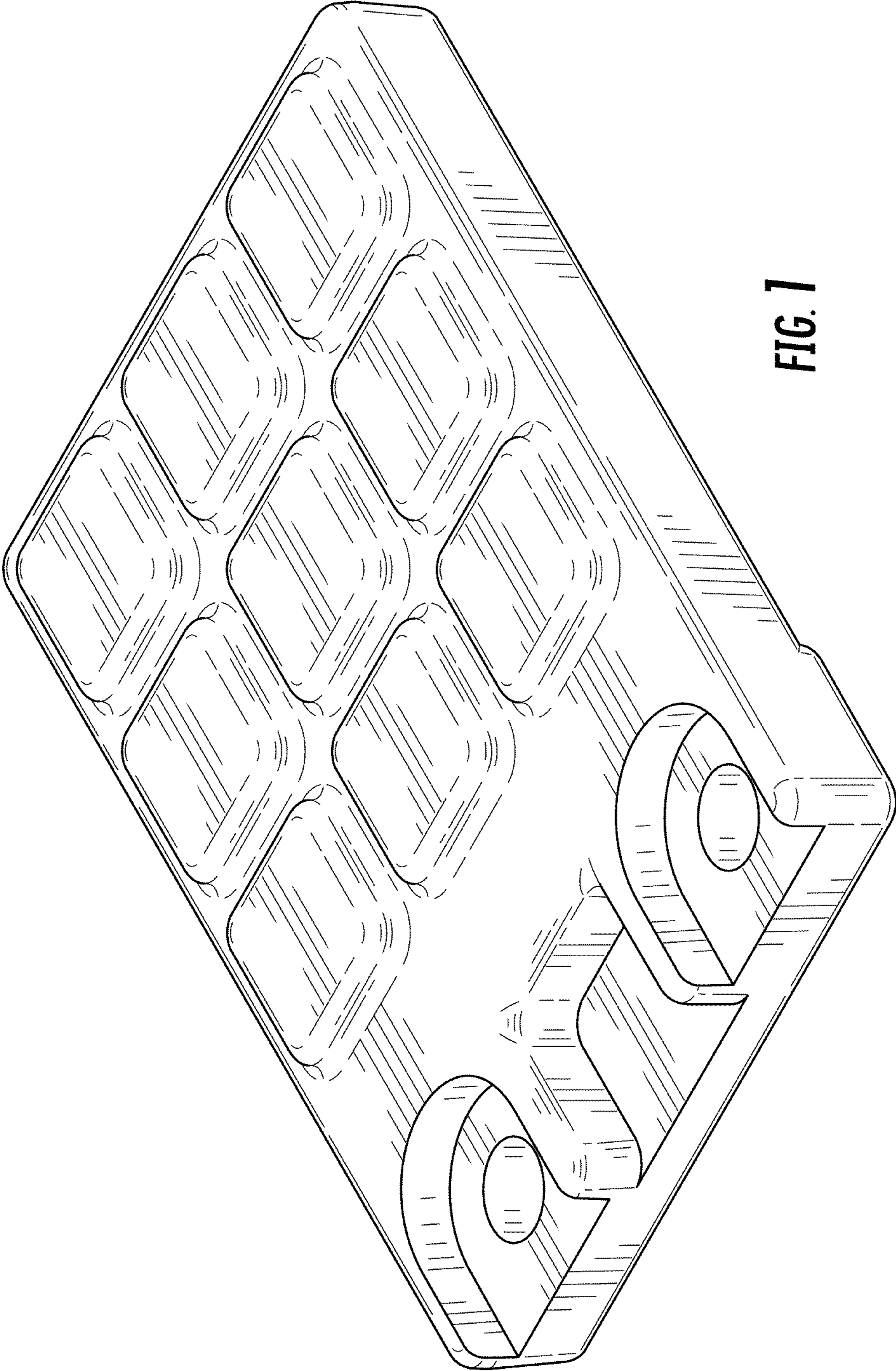

FIG. 1

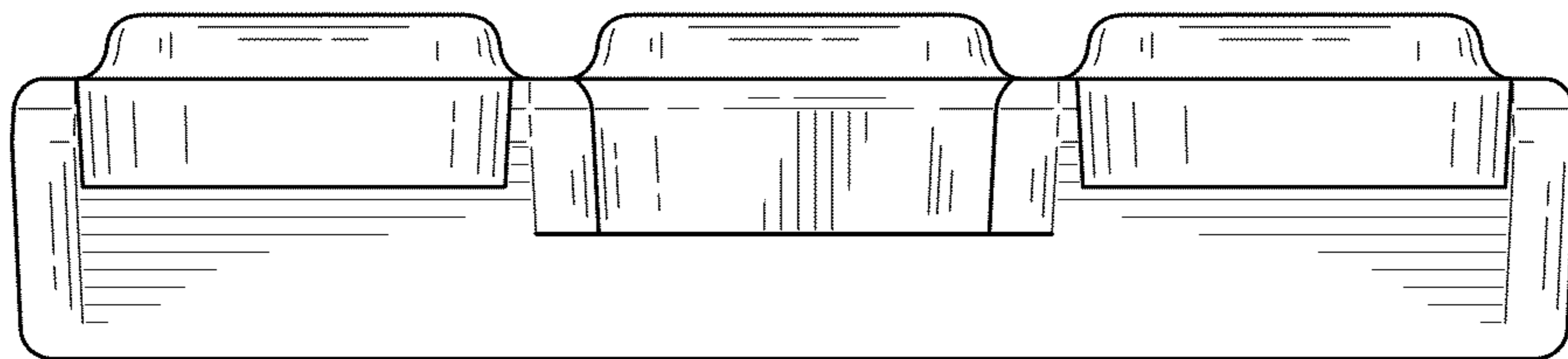

FIG. 2

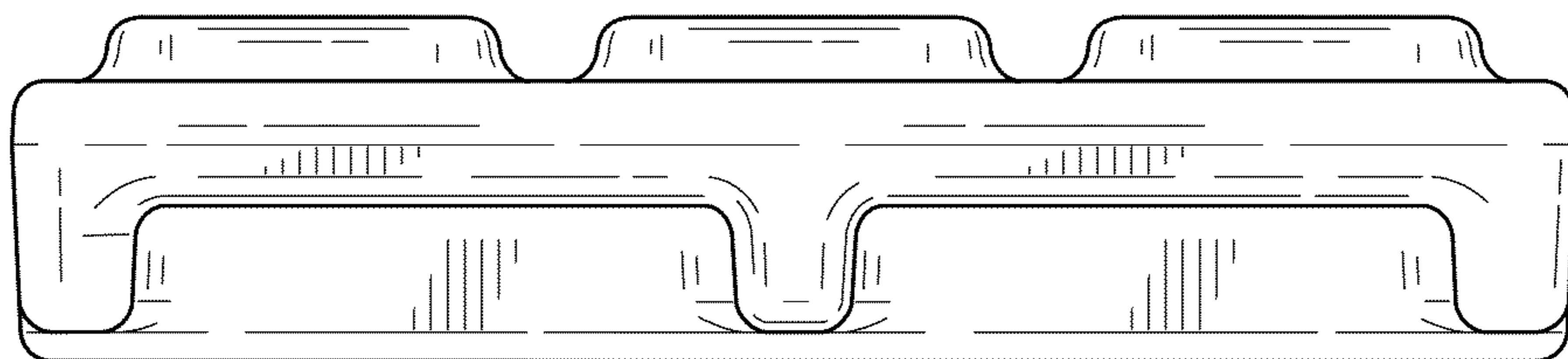

FIG. 3

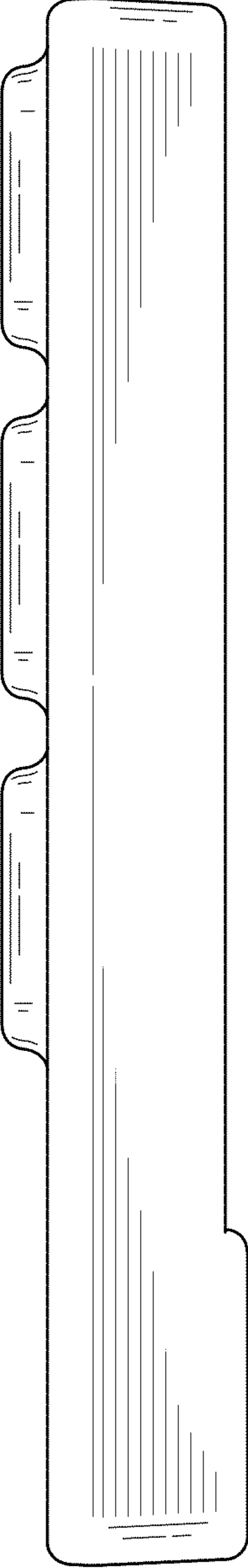

FIG. 4

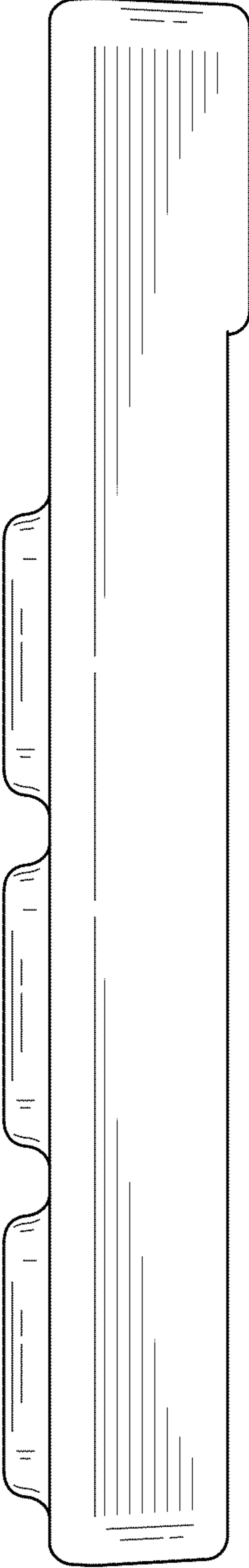

FIG. 5

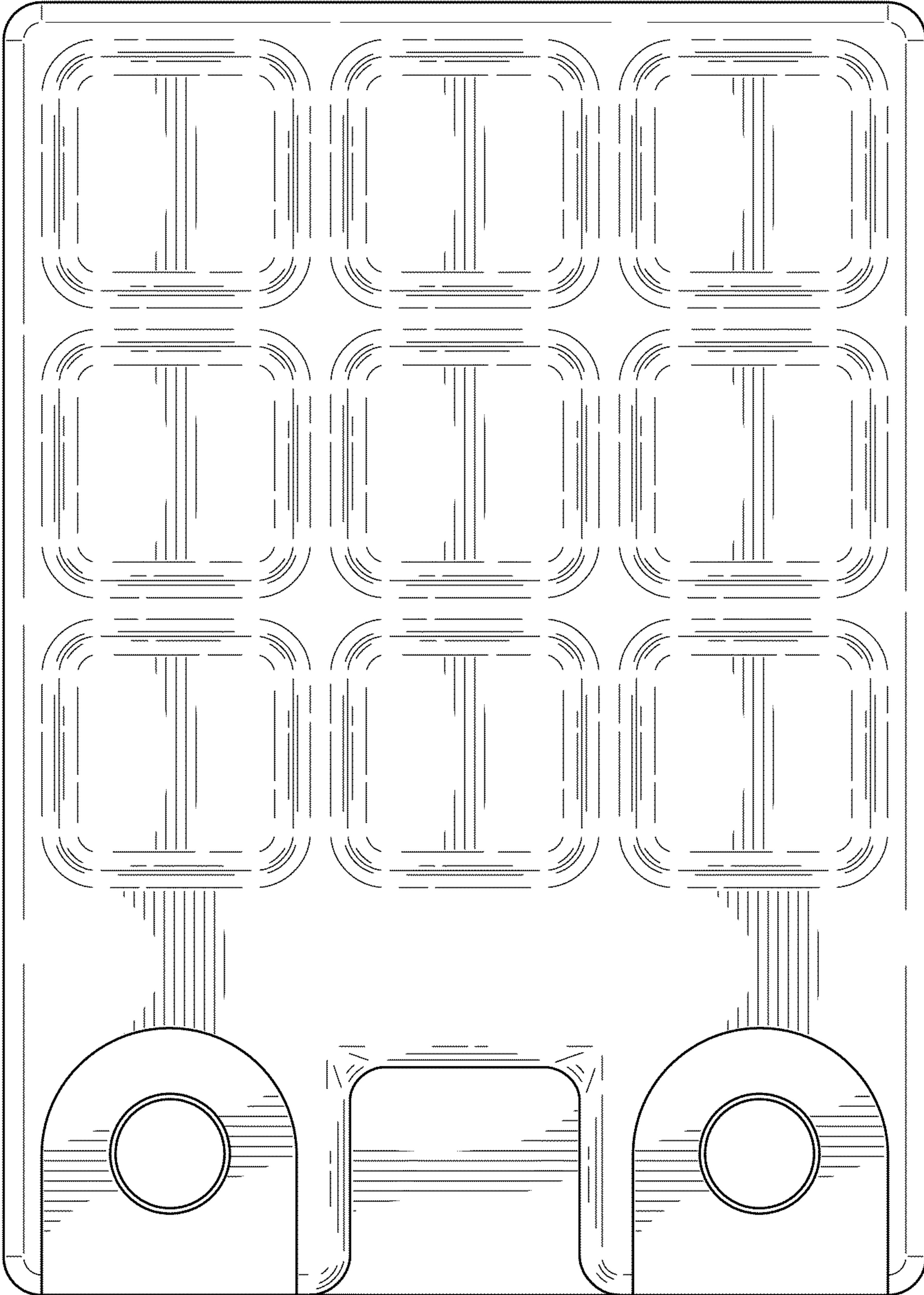

FIG. 6

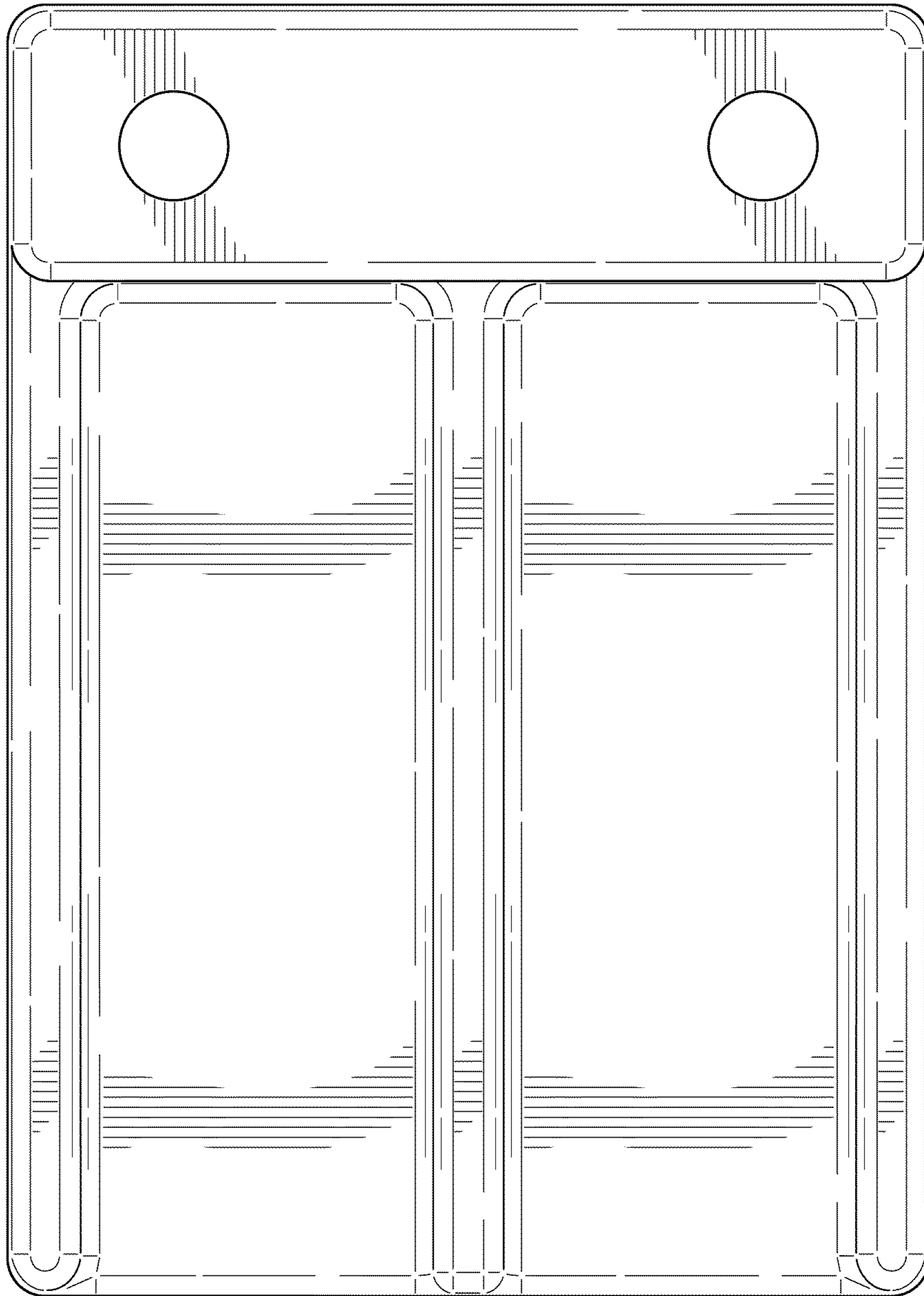

FIG. 7