



US00D947509S

(12) **United States Design Patent** (10) **Patent No.:** **US D947,509 S**
Stiff (45) **Date of Patent:** **** Apr. 5, 2022**

(54) **SOLE STRUCTURE**
(71) Applicant: **Under Armour, Inc.**, Baltimore, MD (US)
(72) Inventor: **Donald Stiff**, Portland, OR (US)
(73) Assignee: **UNDER ARMOUR, INC.**, Baltimore, MD (US)
(**) Term: **15 Years**
(21) Appl. No.: **29/799,600**
(22) Filed: **Jul. 15, 2021**

Assistant Examiner — Jonathan J Han
(74) *Attorney, Agent, or Firm* — Edell, Shapiro & Finnan, LLC

(57) **CLAIM**

The ornamental design for a sole structure, as shown and described.

DESCRIPTION

FIG. 1 is a lateral side and bottom view in perspective of a sole structure showing my new design; FIG. 2 is a lateral side view thereof; FIG. 3 is a medial side view thereof; FIG. 4 is a top view thereof; FIG. 5 is a bottom view thereof; FIG. 6 is a front view thereof; FIG. 7 is a rear view thereof; FIG. 8 is another lateral side and bottom view in perspective thereof; and FIG. 9 is a medial side and bottom view in perspective thereof; FIG. 10 is a lateral side and bottom view in perspective of a sole structure showing my new design; FIG. 11 is a lateral side view of the sole structure of FIG. 10; FIG. 12 is a medial side view of the sole structure of FIG. 10; FIG. 13 is a top view of the sole structure of FIG. 10; FIG. 14 is a bottom view of the sole structure of FIG. 10; FIG. 15 is a front view of the sole structure of FIG. 10; FIG. 16 is a rear view of the sole structure of FIG. 10; FIG. 17 is another lateral side and bottom view in perspective of the sole structure of FIG. 10; and, FIG. 18 is a medial side and bottom view in perspective of the sole structure of FIG. 10. The sole structure illustrated in the drawings is a first embodiment showing a right-footed form of the sole structure. A second embodiment is for the left-footed form of the sole structure, which is a mirror image of the right-footed form, is not illustrated. The dashed broken line illustration in the figures, showing environmental structure, is not part of

Related U.S. Application Data

(63) Continuation of application No. 29/703,236, filed on Aug. 26, 2019, now Pat. No. Des. 925,878.
(51) **LOC (13) Cl.** **02-04**
(52) **U.S. Cl.**
USPC **D2/947**; D2/951
(58) **Field of Classification Search**
USPC D2/902, 906, 908, 916, 918, 925, D2/946-962, 977; 36/1, 1.5, 3 B, 22 R,
(Continued)

(56) **References Cited**

U.S. PATENT DOCUMENTS

1,936,729 A * 11/1933 Mebane A43B 13/28 36/32 R
D229,252 S 11/1973 Edmunds
(Continued)

OTHER PUBLICATIONS

Under Armour Men's Tribase Reign 2.0 Cross Trainer, Amazon.com, Date First Available Mar. 22, 2019; <https://www.amazon.com/Under-Armour-Tribase-Reign-Trainer/dp/B07PWNN6J?th=1>, 8 pages.
(Continued)

Primary Examiner — T Chase Nelson

(Continued)

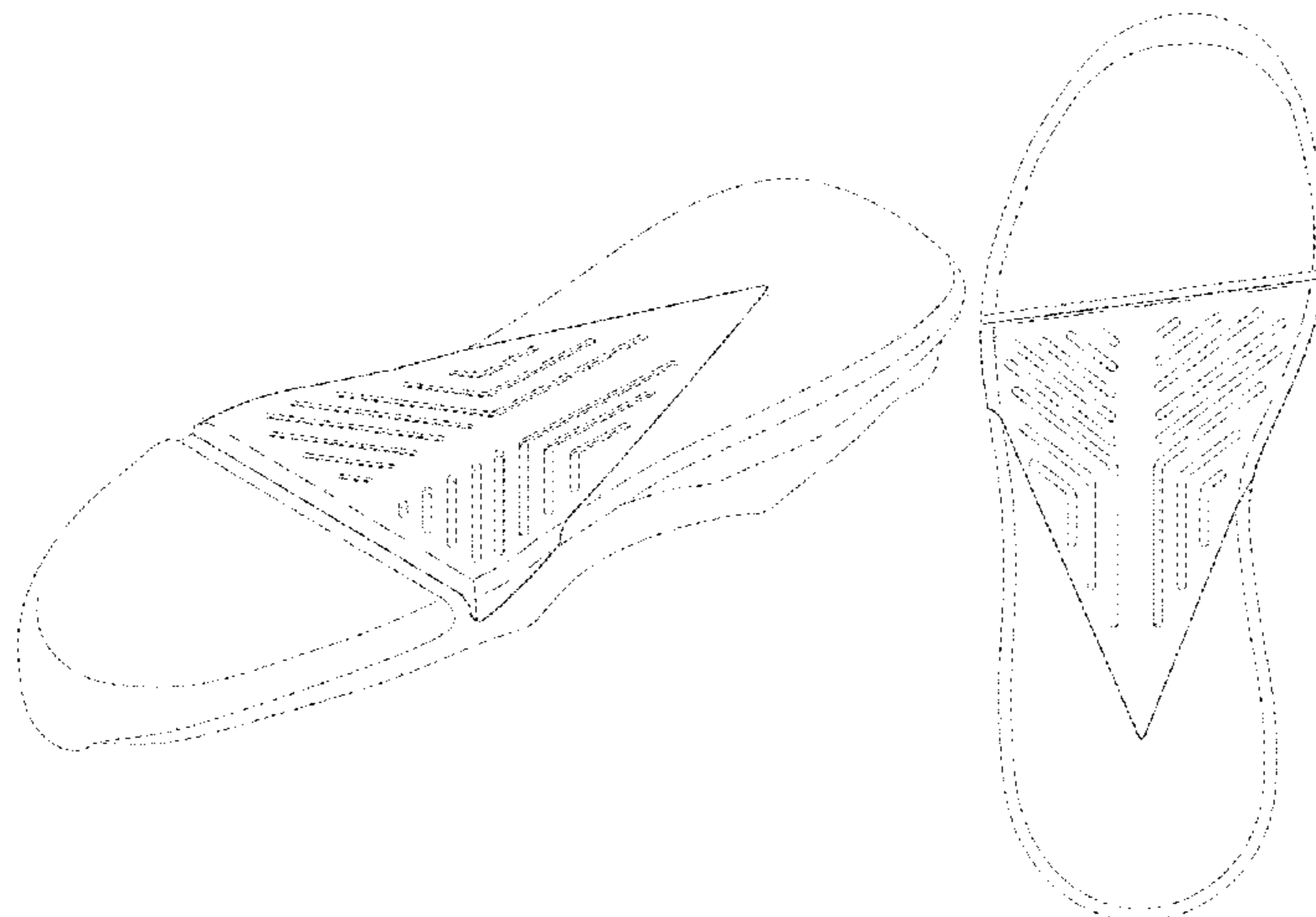

the claimed design. The dot-dash broken line illustration in the figures defines the bounds of the claimed design and forms no part thereof.

1 Claim, 16 Drawing Sheets

(58) Field of Classification Search

USPC 36/24.5, 25 R, 28, 32 R, 34 R, 59 C,
36/67 A, 101-107, 114-116, 117.3, 117.4,
36/124-136
CPC A43B 13/00; A43B 13/02; A43B 13/023;
A43B 13/026; A43B 13/04; A43B 13/08;
A43B 13/10; A43B 13/12; A43B 13/14;
A43B 13/141; A43B 13/143; A43B
13/16; A43B 13/18; A43B 13/181; A43B
13/187; A43B 13/189; A43B 13/20; A43B
13/22; A43B 13/223; A43B 13/24; A43B
13/28; A43B 13/30; A43B 13/32; A43B
13/34; A43B 13/36

See application file for complete search history.

(56) References Cited

U.S. PATENT DOCUMENTS

D321,275 S 11/1991 Austin
D472,699 S 4/2003 Schroeder et al.
D499,239 S * 12/2004 Burg D2/953
D501,708 S 2/2005 Andrews-Kramer
D531,788 S 11/2006 Rittberg
D545,035 S * 6/2007 Roulo D2/951
D561,442 S * 2/2008 Kayano D2/953
D577,183 S * 9/2008 Link D2/951
D577,184 S * 9/2008 McMillan D2/951
D584,036 S 1/2009 Selbiger
D586,093 S * 2/2009 Mermert D2/951
D586,994 S * 2/2009 Chang D2/951
D625,500 S * 10/2010 Dekovic D2/959
D627,144 S * 11/2010 Bettencourt D2/951
D646,874 S * 10/2011 Miner D2/959
D648,516 S 11/2011 Yi
D689,680 S 9/2013 Chang

D735,453 S * 8/2015 Monroy D2/957
D754,424 S 4/2016 Spring
D776,903 S 1/2017 Howe
D778,565 S 2/2017 Sars
D783,973 S 4/2017 Anceresi
D797,412 S 9/2017 Taestensen
D802,895 S * 11/2017 Hatfield D2/951
D813,509 S 3/2018 O'Connor
10,039,343 B2 8/2018 Guyan
D833,724 S 11/2018 Link et al.
D840,648 S 2/2019 Enayah
D848,722 S 5/2019 Ruark
D852,484 S 7/2019 Newmann
D855,299 S 8/2019 Loverin
D862,860 S 10/2019 Sokol
10,426,226 B2 10/2019 Guyan
D866,139 S 11/2019 Durlflinger
D866,933 S 11/2019 Mazza
D866,934 S 11/2019 Zeng
D876,058 S 2/2020 Shyllon
D884,325 S 5/2020 O'Connor
D885,736 S 6/2020 Radabaugh
D889,102 S 7/2020 Hatfield et al.
D889,792 S * 7/2020 O'Connor D2/953
D892,483 S 8/2020 Lv
D899,739 S 10/2020 Goldberg
D904,742 S 12/2020 Stiff
D904,743 S 12/2020 Stiff
D911,006 S * 2/2021 Toelle D2/960
10,918,161 B2 * 2/2021 Bray, Jr. A43B 3/107
D917,852 S * 5/2021 Holmes D2/953
D925,878 S * 7/2021 Stiff D2/960
D932,160 S * 10/2021 Figur D2/953
D932,161 S * 10/2021 Figur D2/953
2011/0094125 A1 4/2011 Weightman
2017/0156443 A1 6/2017 Guyan et al.
2018/0206594 A1 7/2018 Smith et al.

OTHER PUBLICATIONS

Under Armour TriBase reign 2, RunRepeat.com, Nicholas Rizzo, <https://runrepeat.com/under-armour-tribase-reign-2>, 2020, 6 pages.
Brooks Women's Launch 6, Amazon.com, Date first available, May 15, 2018, <https://www.amazon.com/Brooks-Womens-Launch-Ebony-Purple/dp/B07FW3W75R/ref=sr>, 2018, 10 pages.

* cited by examiner

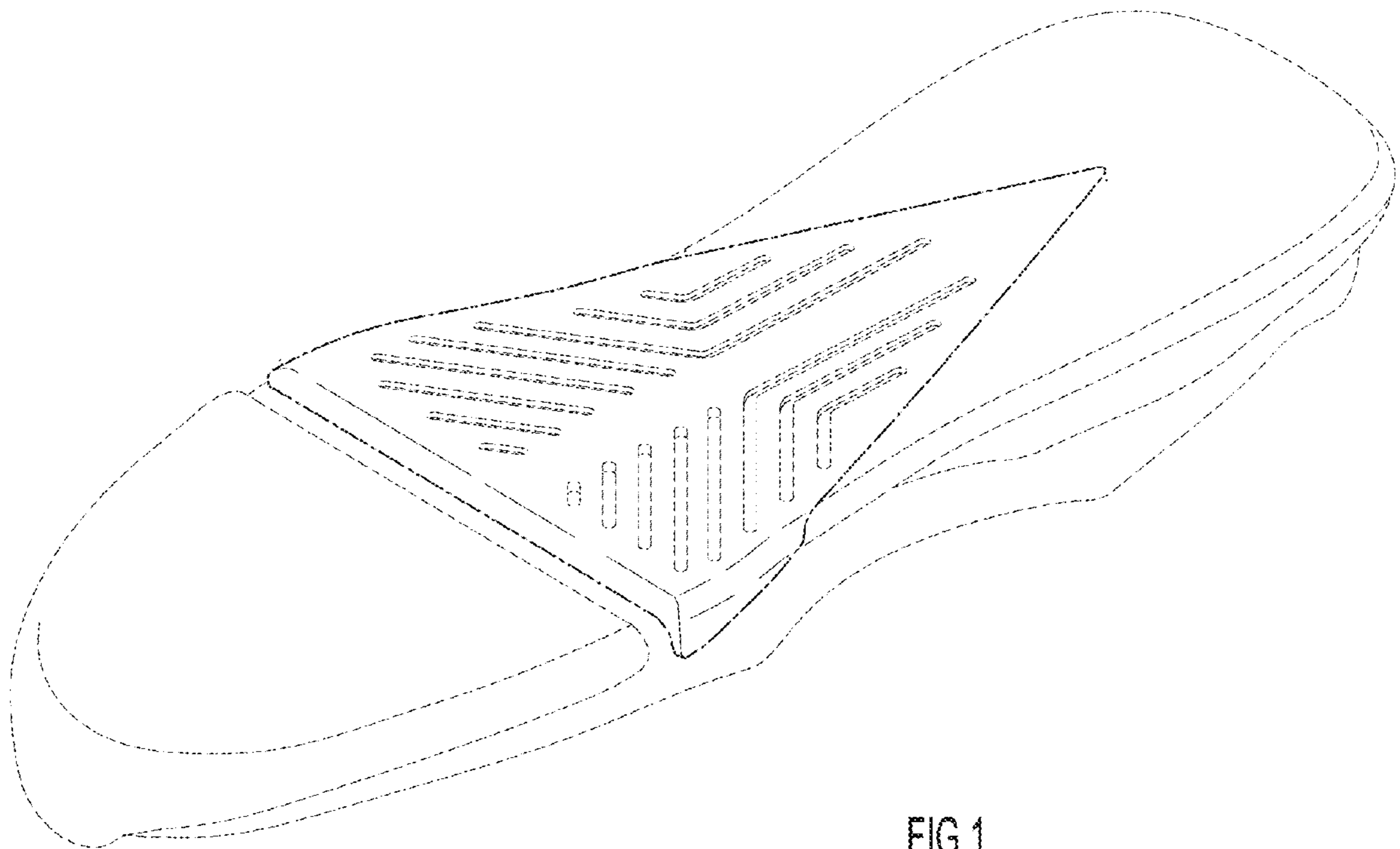

FIG. 1

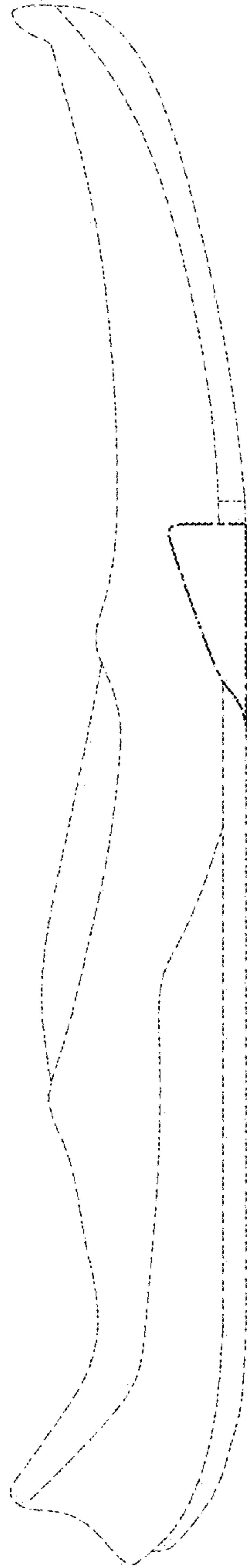

FIG.2

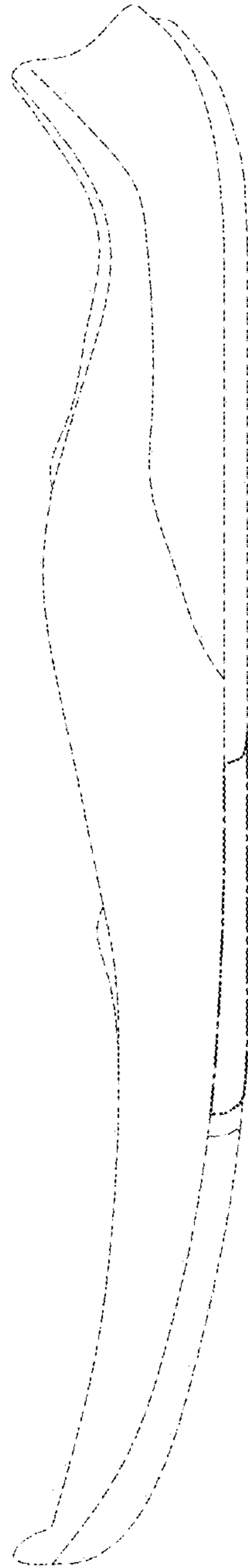

FIG.3

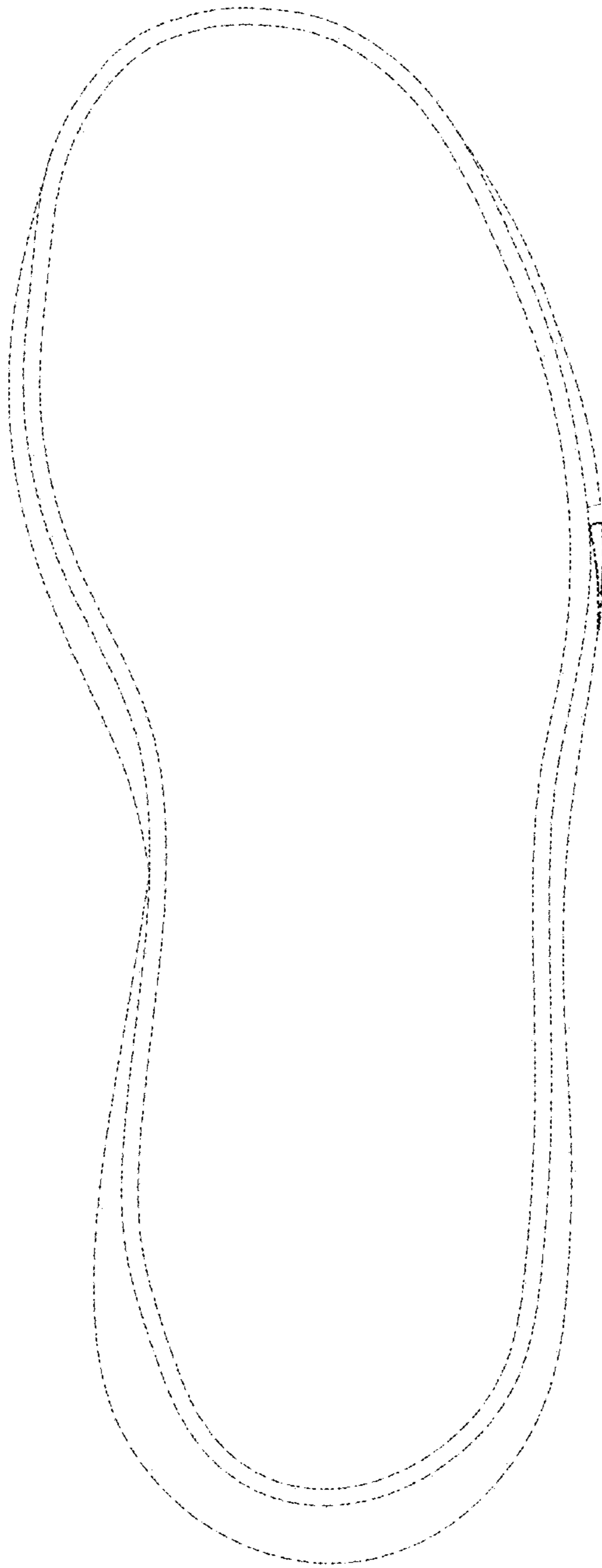

FIG.4

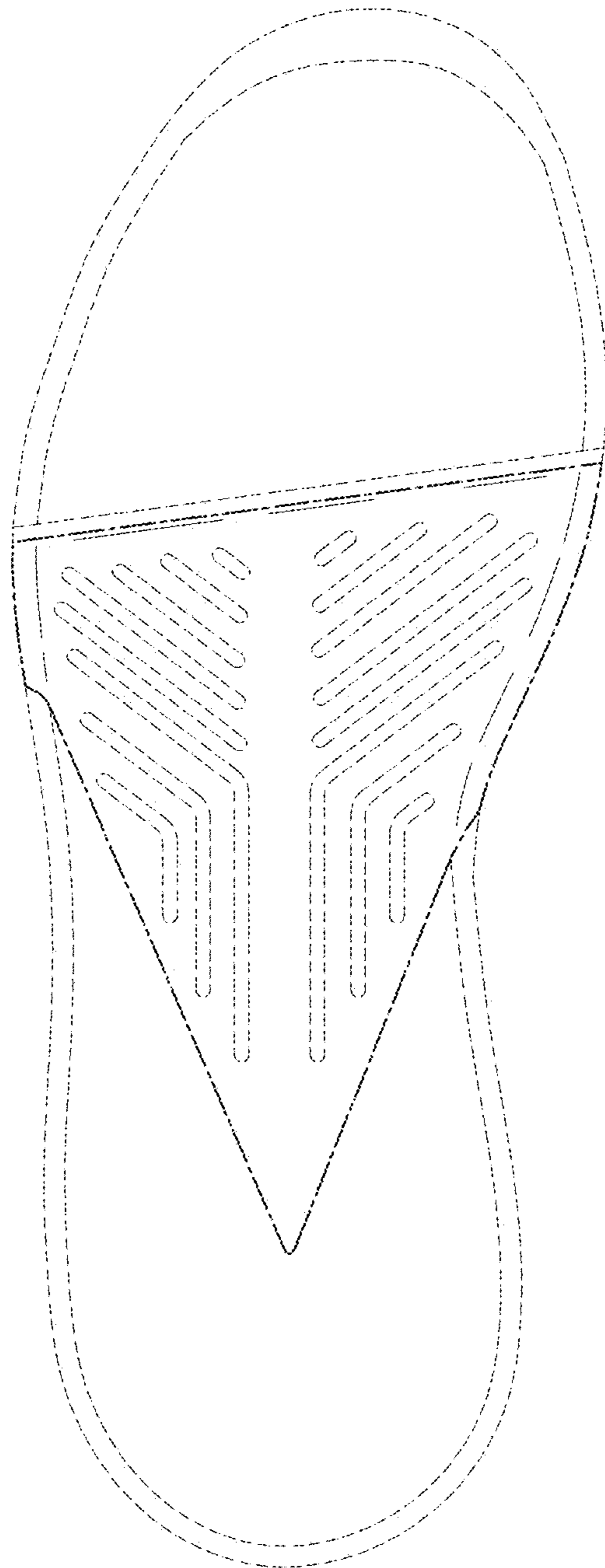

FIG. 5

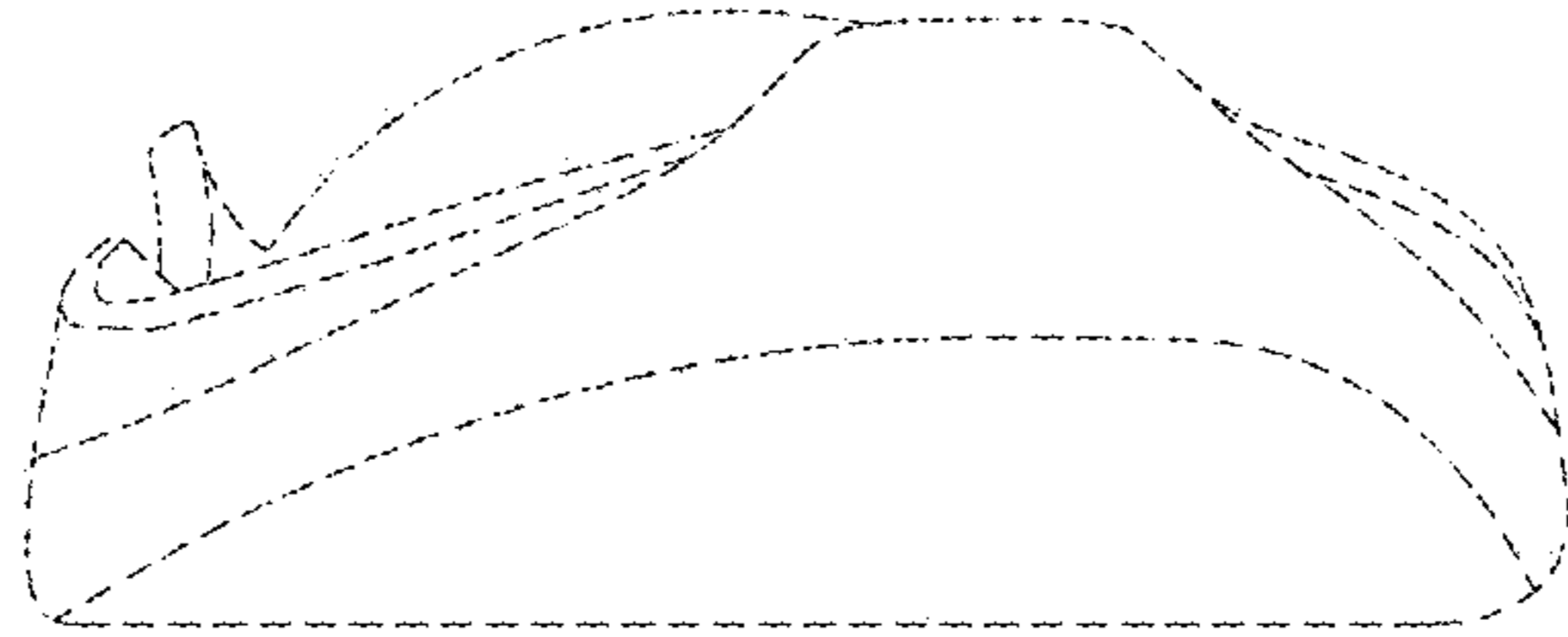

FIG. 6

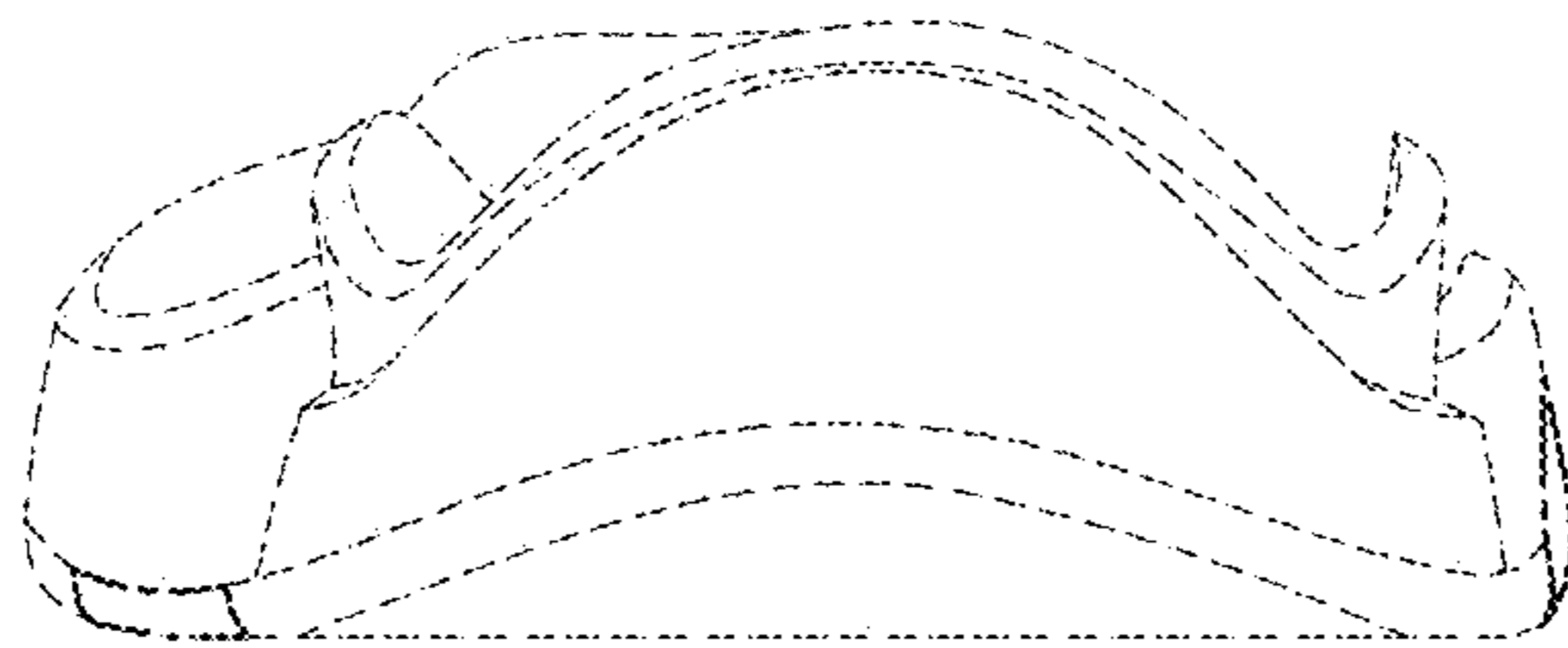

FIG. 7

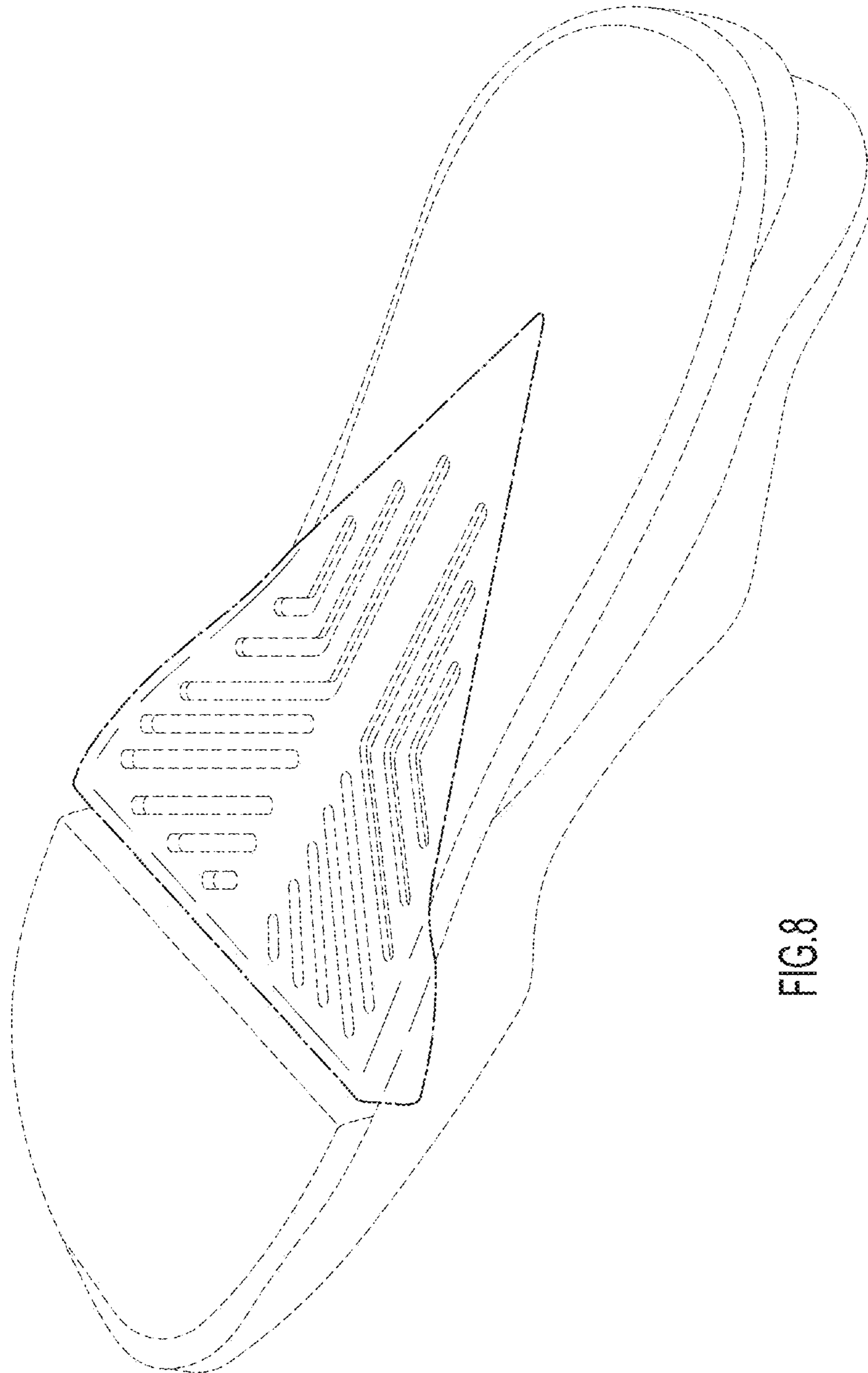

FIG. 8

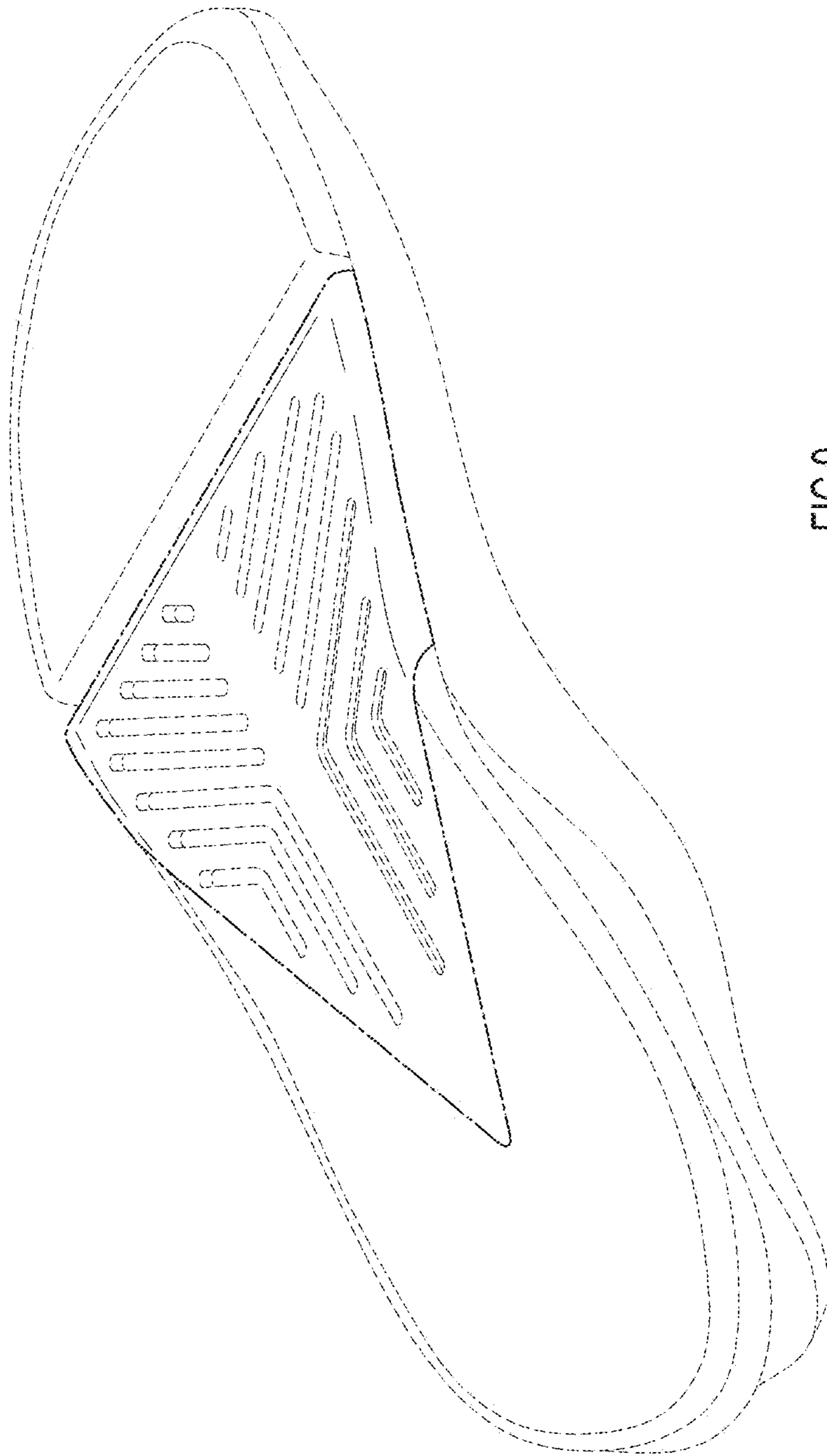

FIG. 9

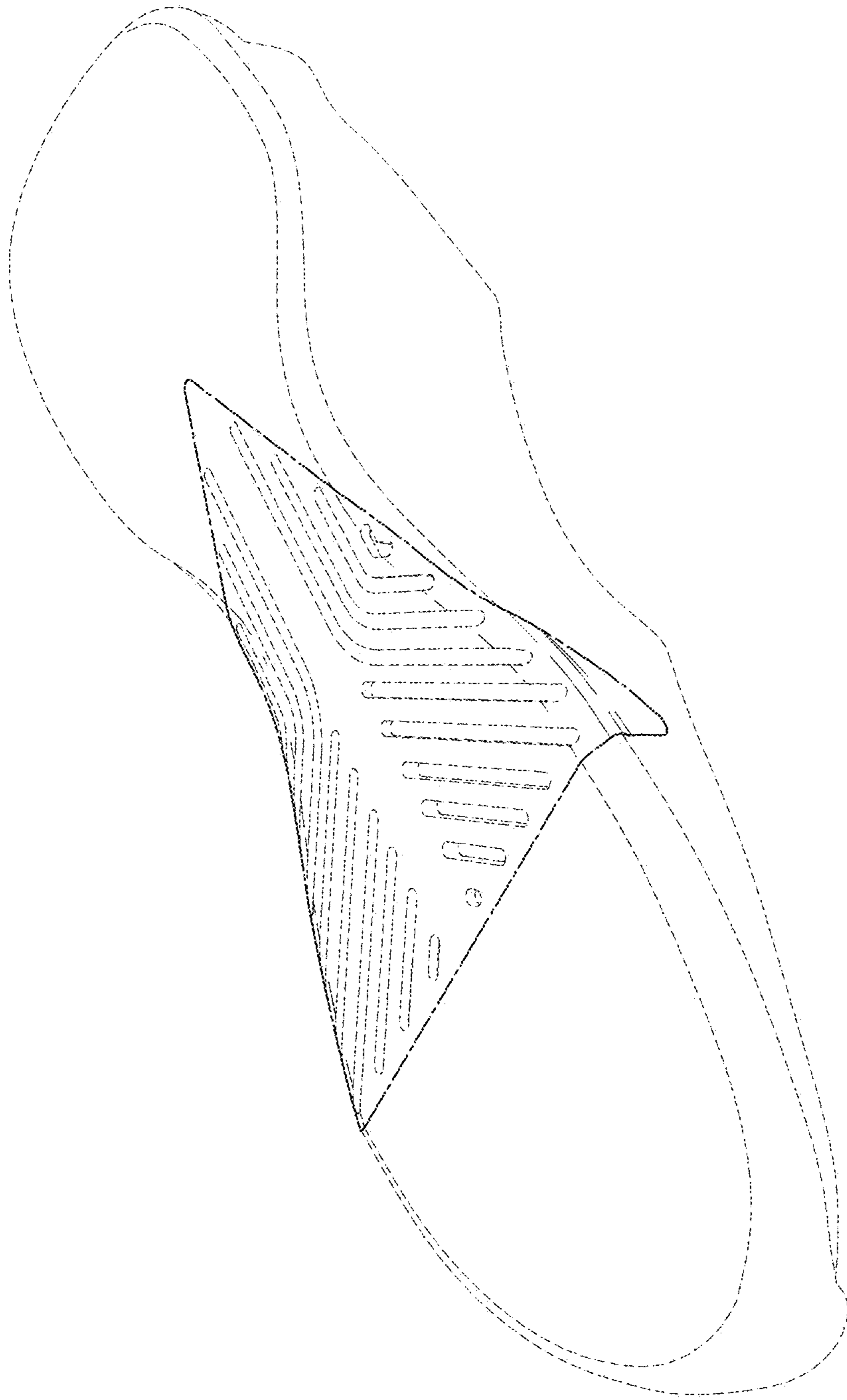

FIG.10

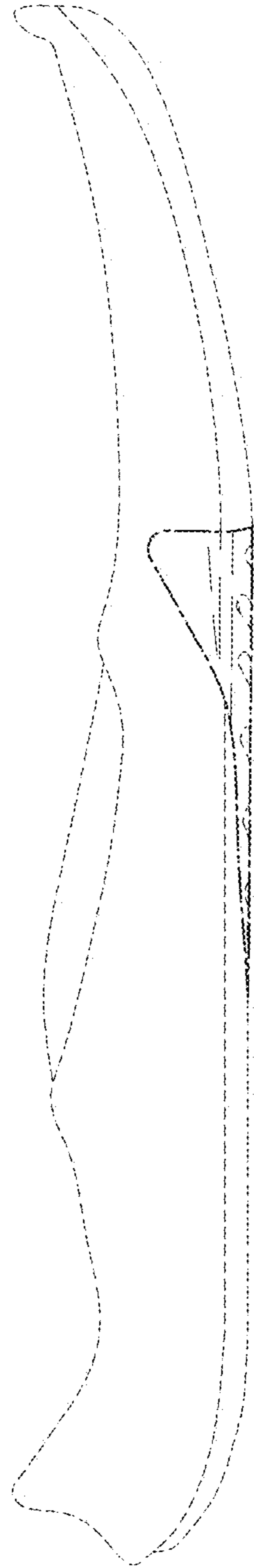

FIG.11

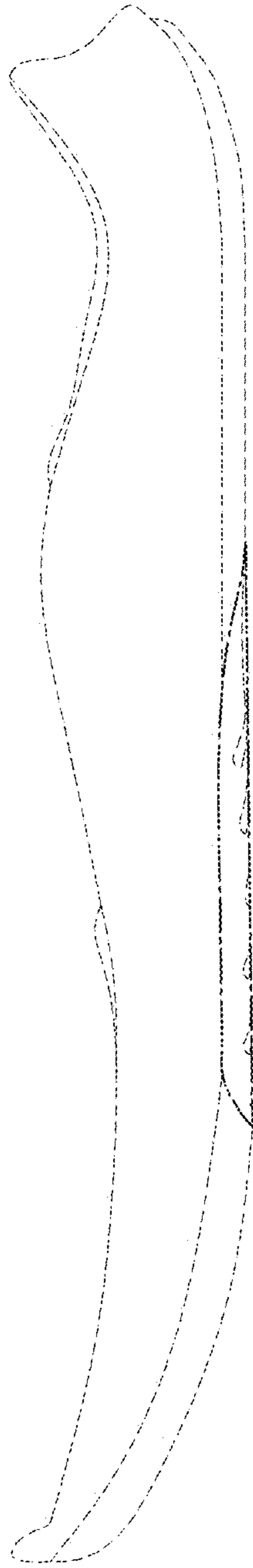

FIG.12

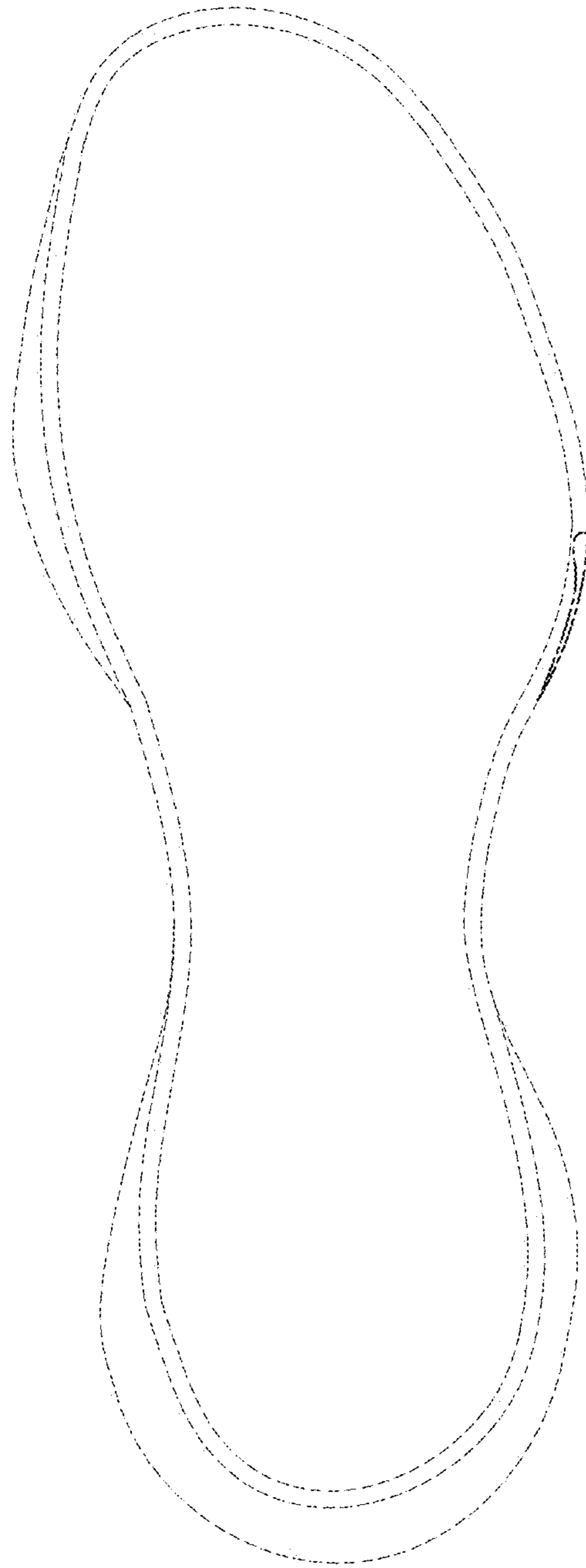

FIG.13

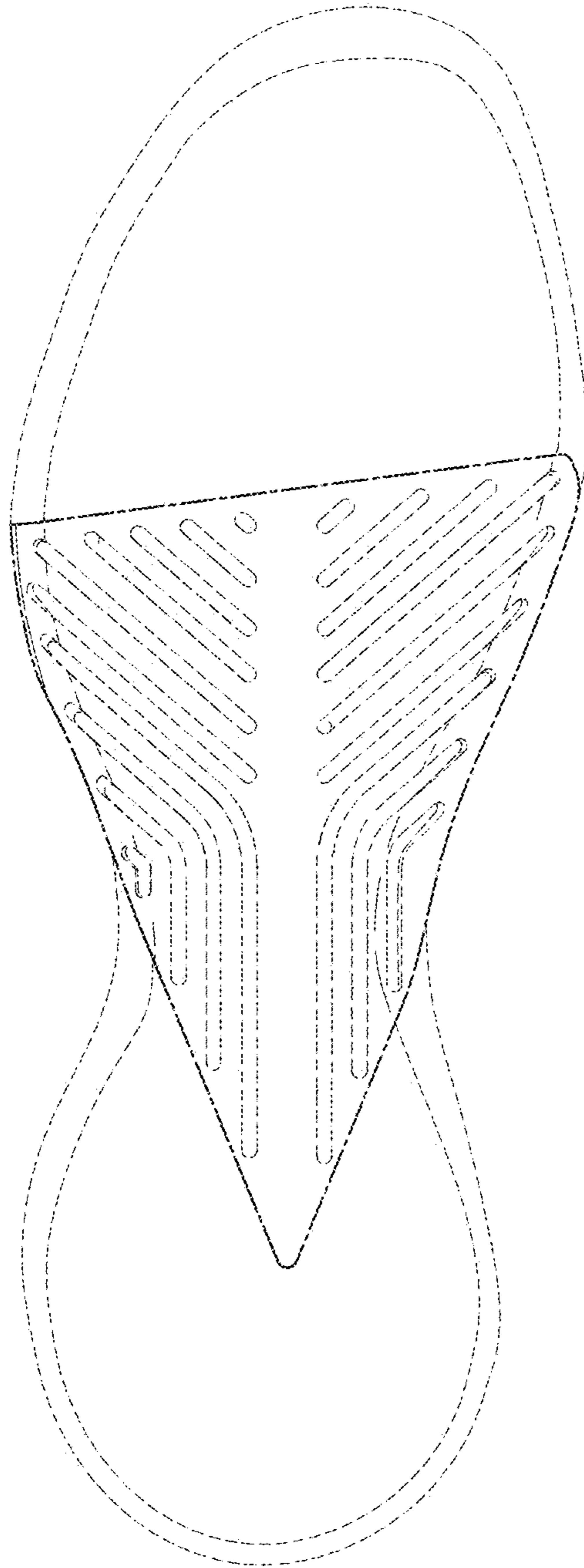

FIG.14

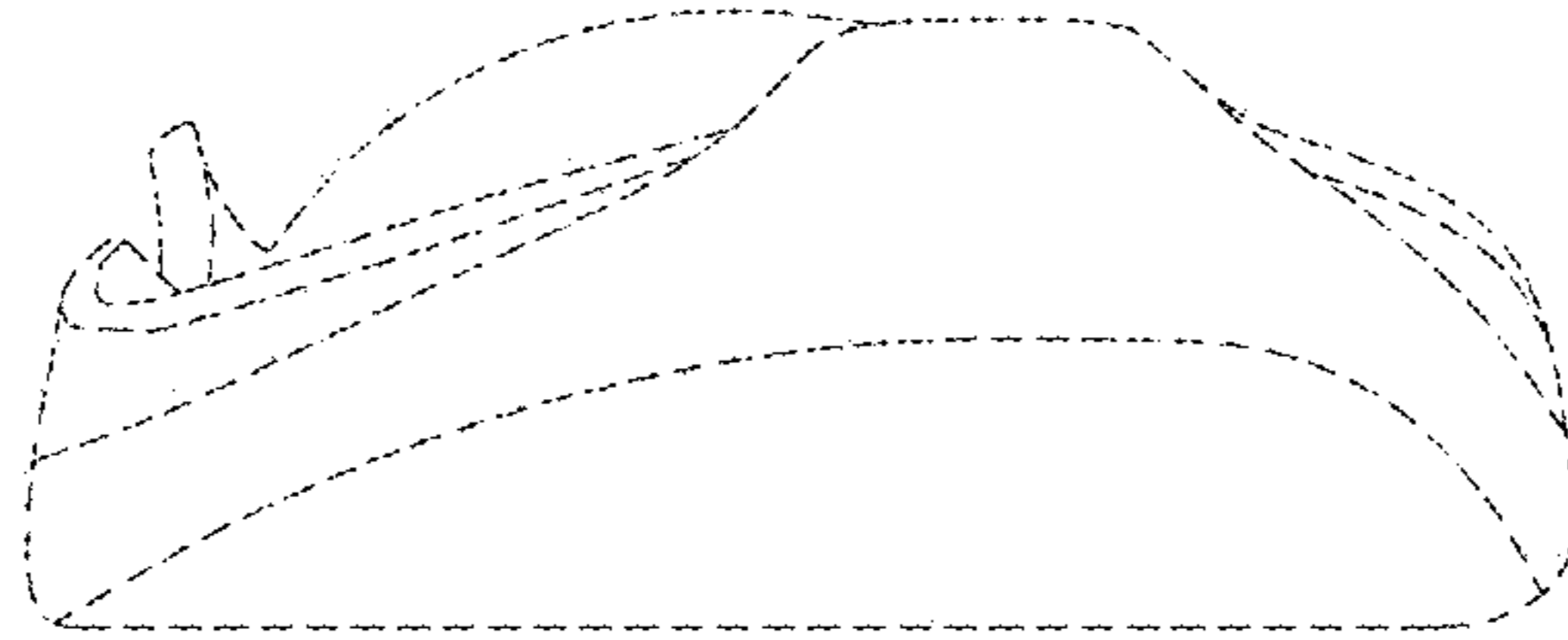

FIG.15

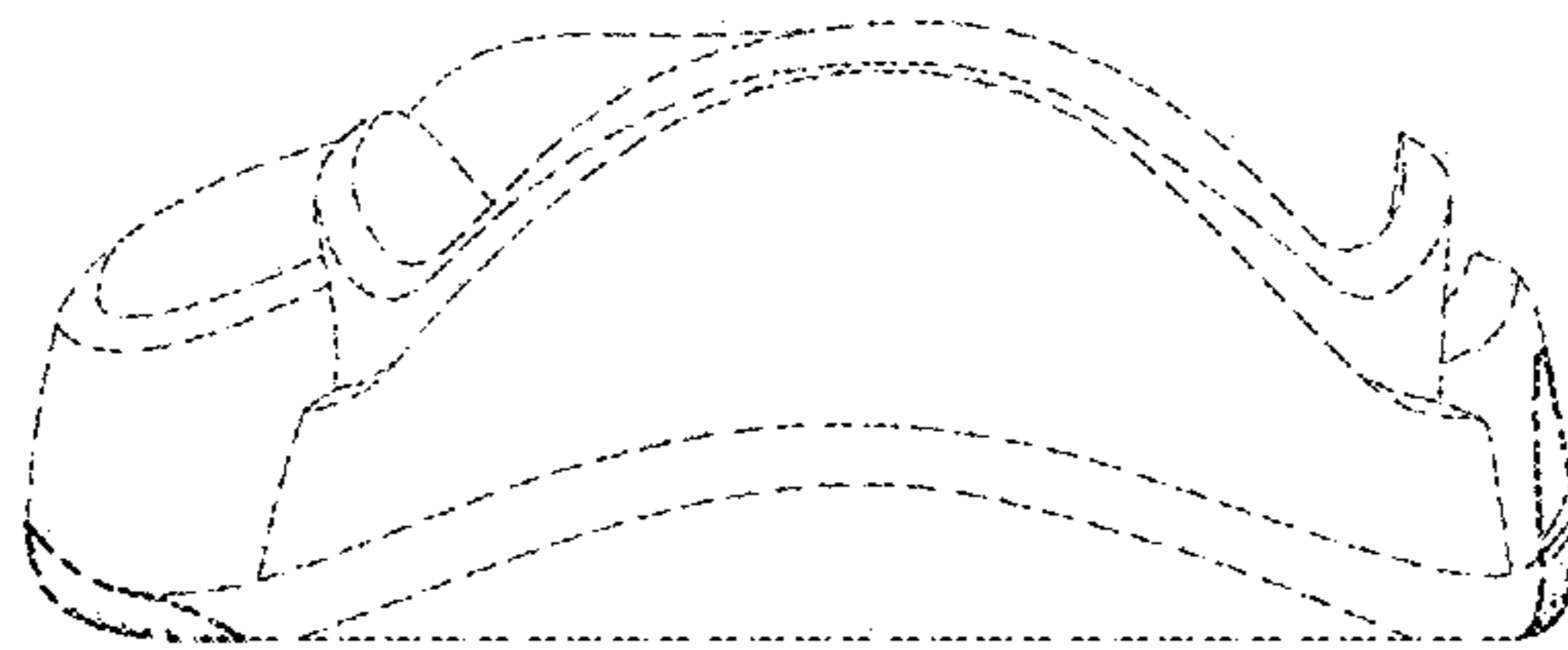

FIG.16

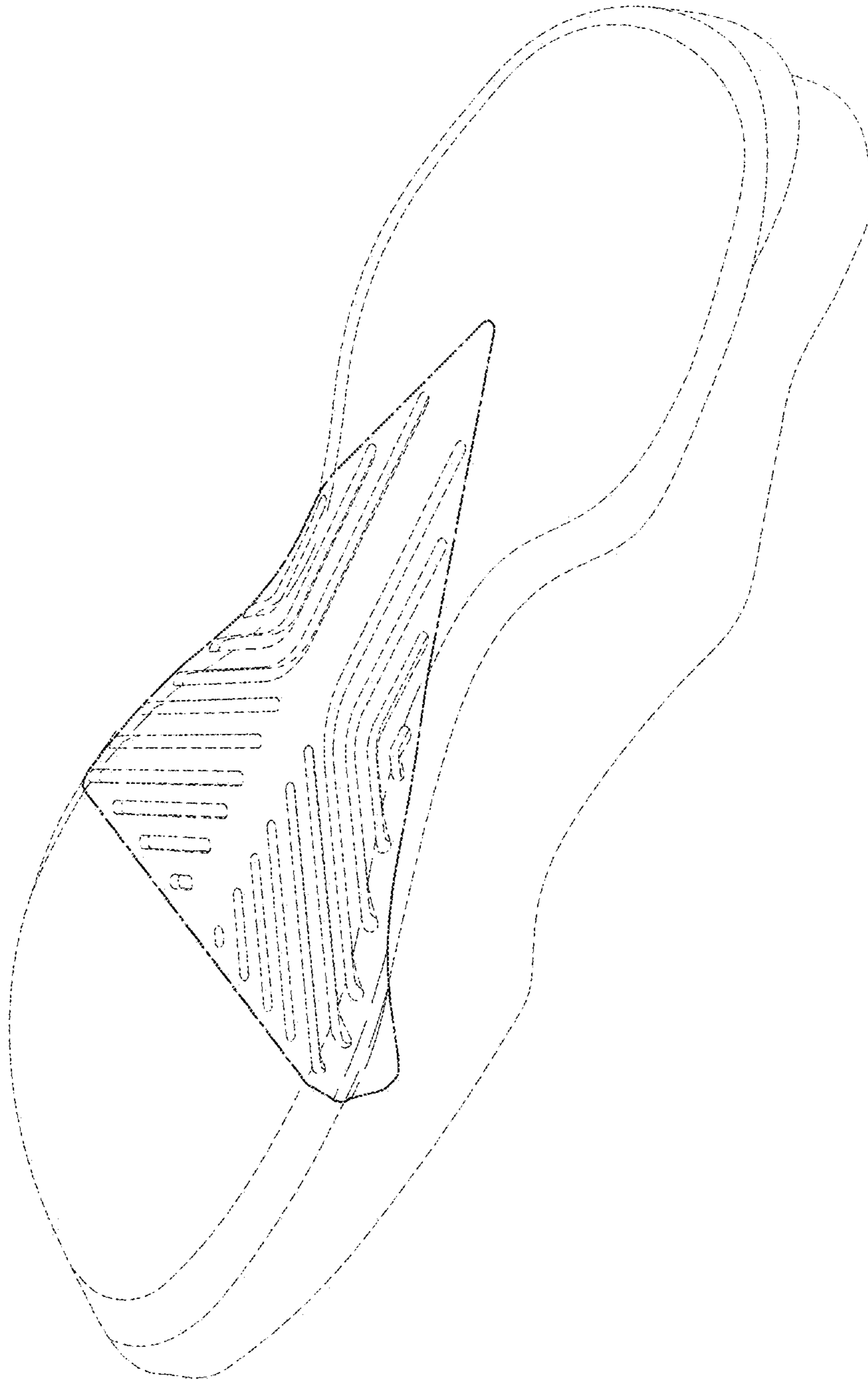

FIG.17

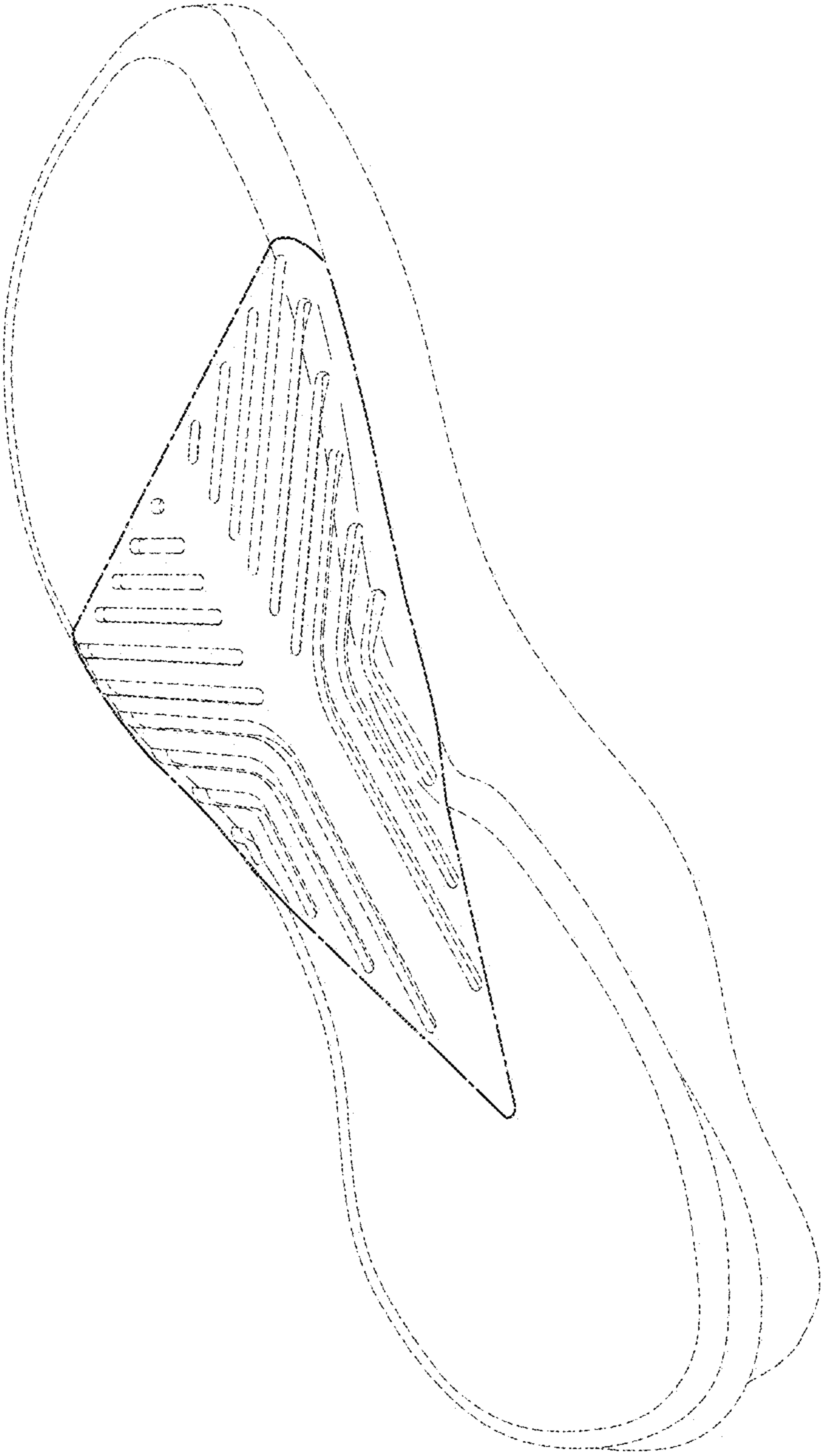

FIG.18