



US00D947489S

(12) **United States Design Patent**  
**Polak et al.**

(10) **Patent No.:** **US D947,489 S**  
(45) **Date of Patent:** **\*\* Apr. 5, 2022**

(54) **CONFECTIONERY**

(71) Applicant: **INTERCONTINENTAL GREAT BRANDS LLC**, East Hanover, NJ (US)

(72) Inventors: **William M. Polak**, Budd Lake, NJ (US); **Marissa Letinski**, Morristown, NJ (US)

(73) Assignee: **INTERCONTINENTAL GREAT BRANDS LLC**, East Hanover, NJ (US)

(\*\*) Term: **15 Years**

(21) Appl. No.: **29/726,954**

(22) Filed: **Mar. 6, 2020**

(51) **LOC (13) Cl.** ..... **01-01**

(52) **U.S. Cl.**  
USPC ..... **D1/109; D1/127**

(58) **Field of Classification Search**  
USPC ..... D1/100–130, 199; 426/5, 104, 249, 275, 426/660, 549, 512; D24/101–104;  
(Continued)

(56) **References Cited**

**U.S. PATENT DOCUMENTS**

D224,549 S \* 8/1972 Kroll ..... D21/458  
D327,154 S \* 6/1992 Raimbert ..... D1/106  
(Continued)

**OTHER PUBLICATIONS**

“Limited Edition Maynards Sour Patch Kids Heads & Bodies.”  
GroceryGems. Oct. 17, 2013. Web. Jun. 2, 2021. <<http://grocerygems.blogspot.com/2013/10/limited-edition-maynards-sour-patch.html>>.\*

*Primary Examiner* — Katie Jane Stofko

(74) *Attorney, Agent, or Firm* — Cantor Colburn LLP

(57) **CLAIM**

We claim, the ornamental design for a confectionery, as shown and described.

**DESCRIPTION**

FIG. 1 is a perspective view of a confectionery, showing our new design in a first embodiment;

FIG. 2 is a front view of the embodiment shown in FIG. 1;

FIG. 3 is a rear view of the embodiment shown in FIG. 1;

FIG. 4 is a side view of the embodiment shown in FIG. 1;

FIG. 5 is another side view of the embodiment shown in FIG. 1;

FIG. 6 is a top view of the embodiment shown in FIG. 1;

FIG. 7 is a bottom view of the embodiment shown in FIG. 1;

FIG. 8 is a perspective view of a confectionery, showing our new design in a second embodiment;

FIG. 9 is a front view of the embodiment shown in FIG. 8;

FIG. 10 is a rear view of the embodiment shown in FIG. 8;

FIG. 11 is a side view of the embodiment shown in FIG. 8;

FIG. 12 is another side view of the embodiment shown in FIG. 8;

FIG. 13 is a top view of the embodiment shown in FIG. 8;

FIG. 14 is a bottom view of the embodiment shown in FIG. 8;

FIG. 15 is a perspective view of a confectionery, showing our new design in a third embodiment;

FIG. 16 is a front view of the embodiment shown in FIG. 15;

FIG. 17 is a rear view of the embodiment shown in FIG. 15;

FIG. 18 is a side view of the embodiment shown in FIG. 15;

FIG. 19 is another side view of the embodiment shown in FIG. 15;

FIG. 20 is a top view of the embodiment shown in FIG. 15;

FIG. 21 is a bottom view of the embodiment shown in FIG. 15;

FIG. 22 is a perspective view of a confectionery, showing our new design in a fourth embodiment;

FIG. 23 is a front view of the embodiment shown in FIG. 22;

FIG. 24 is a rear view of the embodiment shown in FIG. 22;

FIG. 25 is a side view of the embodiment shown in FIG. 22;

FIG. 26 is another side view of the embodiment shown in FIG. 22;

(Continued)

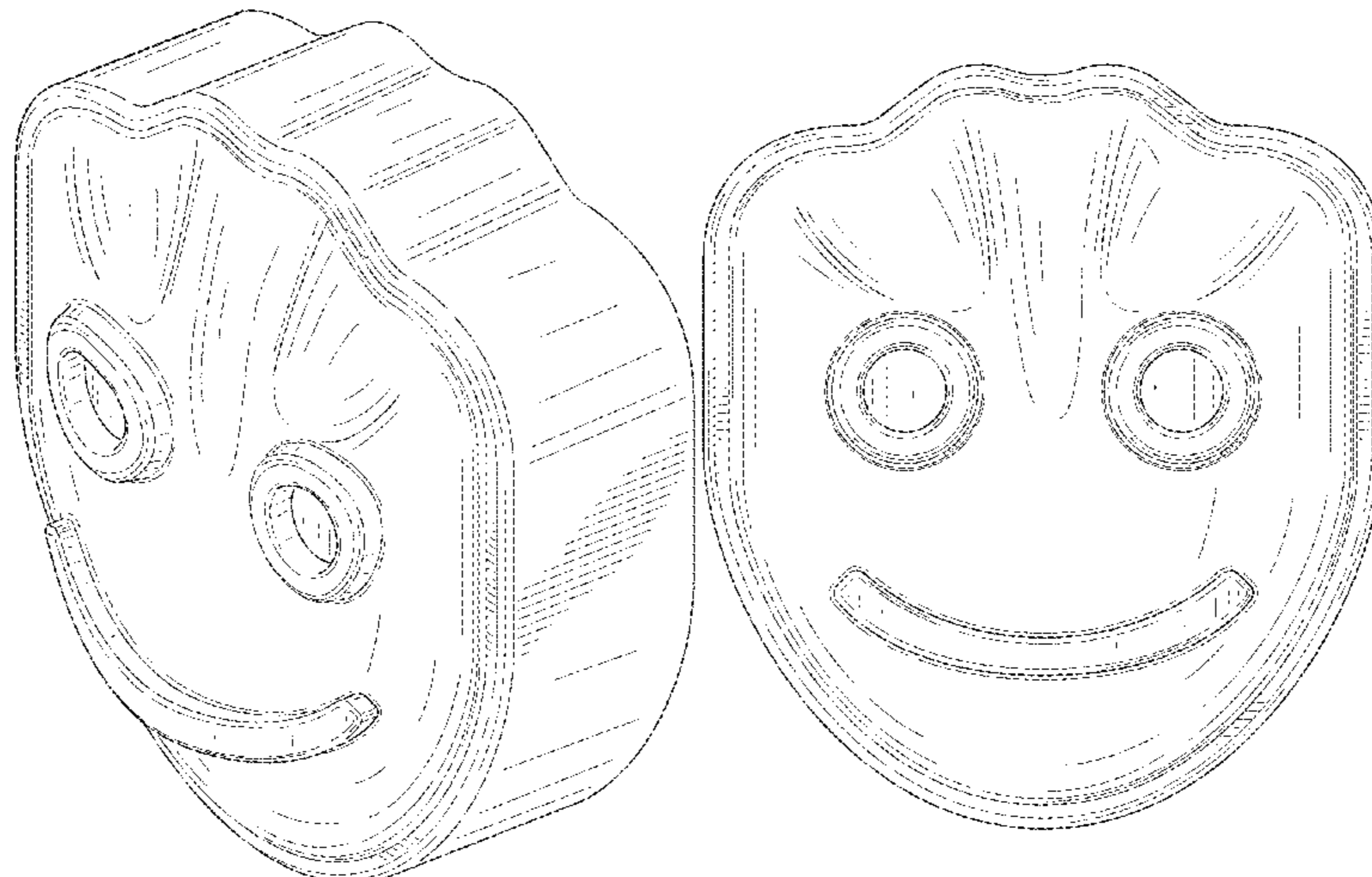

FIG. 27 is a top view of the embodiment shown in FIG. 22; and,

FIG. 28 is a bottom view of the embodiment shown in FIG. 22.

The broken lines shown in the drawings illustrate portions of the confectionery that form no part of the claimed design.

**1 Claim, 24 Drawing Sheets**

(58) **Field of Classification Search**

USPC ..... 273/429; D9/707, 714; D28/8.1, 4; D14/433; D11/20, 31  
 CPC ... A23G 4/02; A23G 4/06; A23G 4/08; A23G 4/10; A23G 4/20; A23G 4/00; A23G 3/38; A23G 3/42; A23G 3/54; A23G 3/50; A23G 9/48; A23K 1/164; A23V 2002/00

See application file for complete search history.

(56) **References Cited**

U.S. PATENT DOCUMENTS

D391,385 S \* 3/1998 Steele ..... 426/104  
 D490,587 S \* 6/2004 Hunt ..... D1/102  
 D515,774 S 2/2006 Martin et al.  
 D517,272 S 3/2006 Deloach  
 D517,273 S \* 3/2006 Harrington ..... D1/108  
 D518,274 S 4/2006 Palmer, Jr. et al.  
 D524,511 S 7/2006 Palmer, Jr. et al.  
 D524,512 S 7/2006 Palmer, Jr. et al.  
 D524,513 S 7/2006 Palmer, Jr. et al.  
 D527,161 S 8/2006 Lucas et al.  
 D527,861 S 9/2006 Deloach  
 D532,182 S 11/2006 Hopkins et al.  
 D539,007 S 3/2007 Clark et al.  
 D545,026 S 6/2007 Martin et al.  
 D556,426 S 12/2007 Slessner et al.  
 D556,427 S 12/2007 Kaiser et al.  
 D560,876 S 2/2008 Rosso  
 D561,426 S 2/2008 Eitler et al.  
 D563,076 S 3/2008 Brooking et al.  
 D563,626 S 3/2008 Edwards et al.  
 D564,176 S 3/2008 Edwards et al.  
 D564,177 S 3/2008 Edwards et al.  
 D564,178 S 3/2008 Edwards et al.  
 D578,729 S 10/2008 Lee

D592,377 S 5/2009 Lee  
 D596,827 S 7/2009 Wilson et al.  
 D598,627 S 8/2009 Damron et al.  
 D598,628 S 8/2009 Damron et al.  
 D598,629 S 8/2009 Damron et al.  
 D598,630 S 8/2009 Damron et al.  
 D598,631 S 8/2009 Damron et al.  
 D598,632 S 8/2009 Damron et al.  
 D602,226 S 10/2009 Hajek  
 D603,129 S 11/2009 Damron et al.  
 D603,130 S 11/2009 Damron et al.  
 D603,131 S 11/2009 Damron et al.  
 D604,928 S 12/2009 Adamson et al.  
 D609,877 S 2/2010 Kadow-Dougherty  
 D611,676 S 3/2010 Damron et al.  
 D613,476 S 4/2010 Lee  
 D622,929 S 9/2010 Anderson  
 D622,930 S 9/2010 Krumholz et al.  
 D632,047 S 2/2011 Weiss et al.  
 D634,509 S 3/2011 Greer et al.  
 D635,327 S 4/2011 Hollmann  
 D635,328 S 4/2011 Mansouri  
 D636,966 S 5/2011 Weiss et al.  
 D636,967 S 5/2011 Weiss et al.  
 D636,968 S 5/2011 Weiss et al.  
 D637,786 S 5/2011 Anderson et al.  
 D648,916 S 11/2011 Rexroad  
 D650,556 S 12/2011 Anderson et al.  
 D650,966 S 12/2011 Maher  
 D655,887 S 3/2012 Zbuchalski  
 D665,966 S 8/2012 Anderson  
 D668,017 S 10/2012 Coble  
 D669,656 S 10/2012 Coble et al.  
 D684,336 S 6/2013 Couttenye et al.  
 D695,988 S \* 12/2013 Trammell ..... D1/106  
 D715,017 S 10/2014 Petrie  
 D728,192 S \* 5/2015 Neely ..... D1/109  
 D728,893 S 5/2015 Beressey et al.  
 D730,616 S 6/2015 Keating et al.  
 D731,142 S 6/2015 Clement et al.  
 D732,266 S 6/2015 Mederer  
 D738,066 S 9/2015 Mederer  
 D765,829 S 9/2016 Shenoy  
 D768,351 S \* 10/2016 Sherman ..... D1/108  
 D768,352 S \* 10/2016 Sherman ..... D1/108  
 D779,150 S \* 2/2017 Sherman ..... D1/108  
 D785,277 S 5/2017 Reddick et al.  
 D866,917 S 11/2019 Anthony  
 D869,816 S 12/2019 Kim  
 2008/0213436 A1 \* 9/2008 Mansuino ..... A23G 1/0066  
 426/103

\* cited by examiner

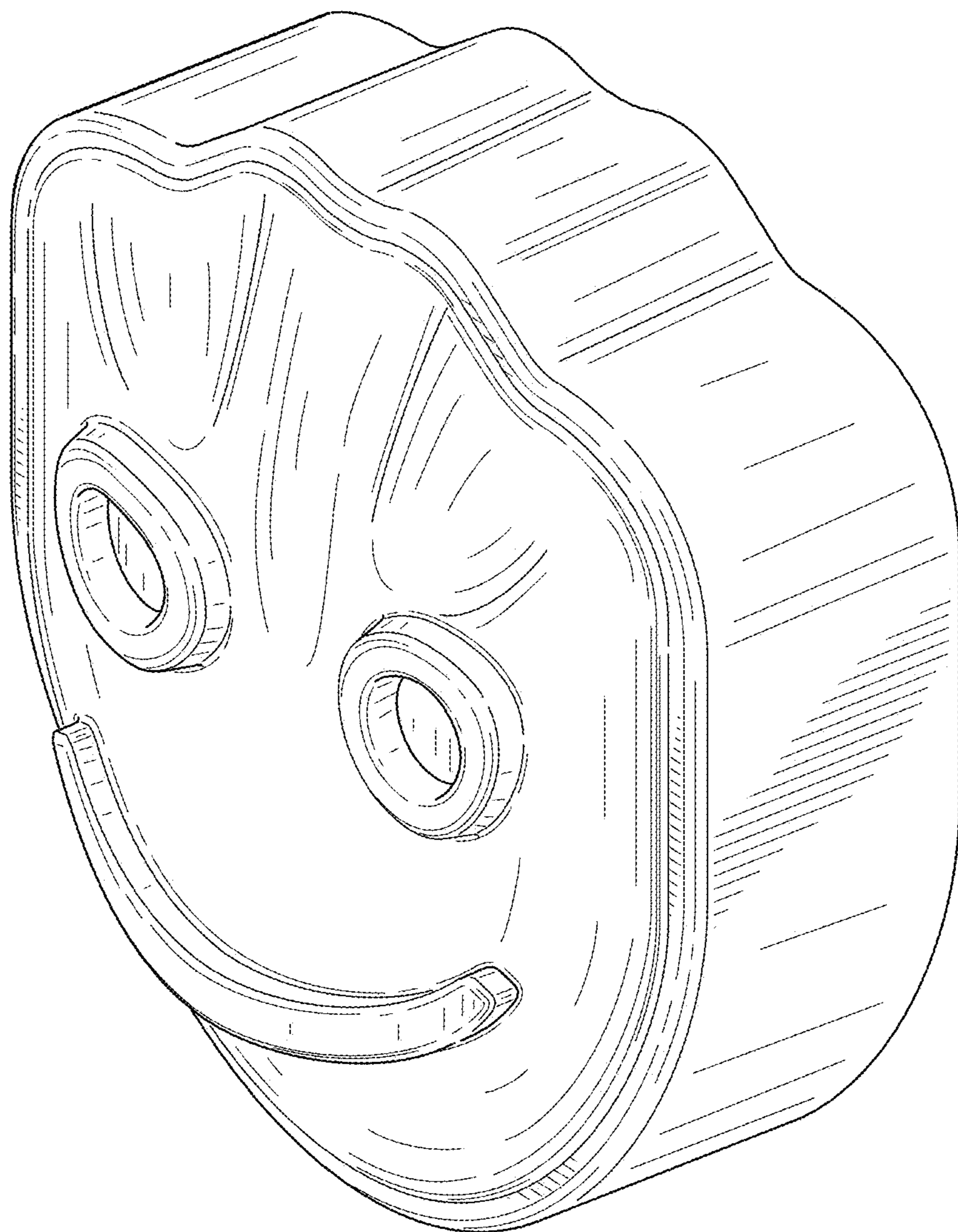

FIG. 1

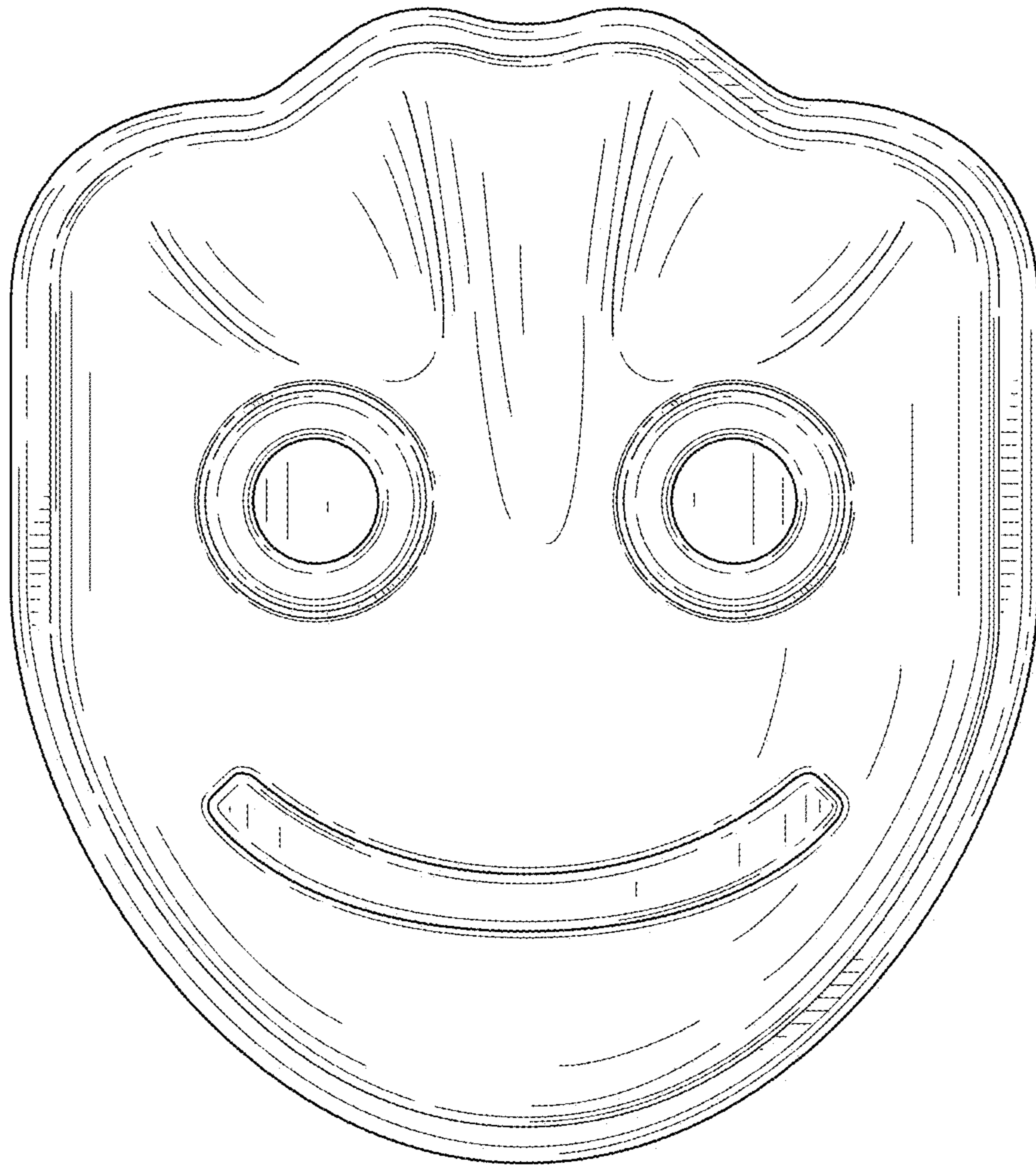

FIG. 2

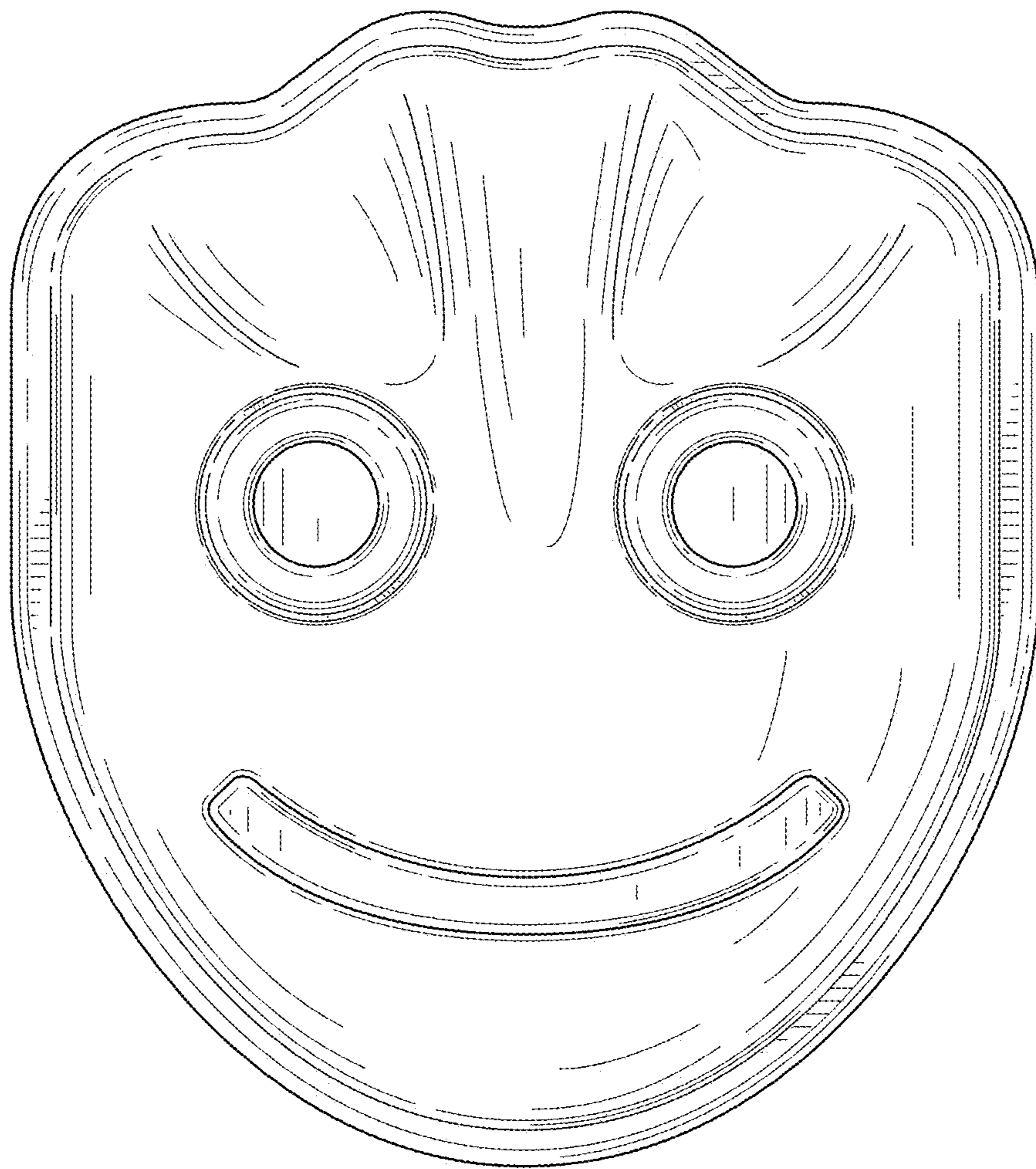

FIG. 3

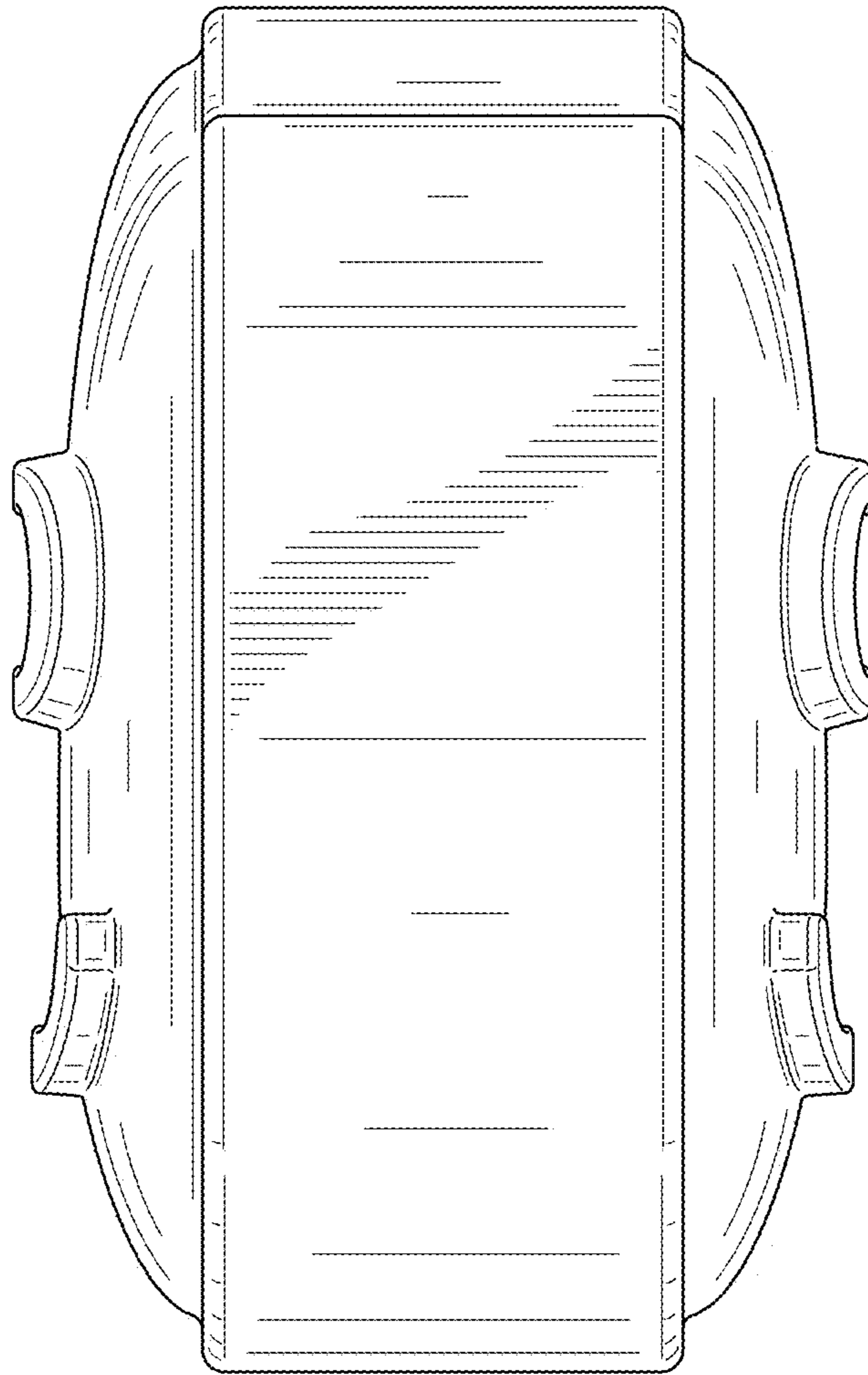

FIG. 4

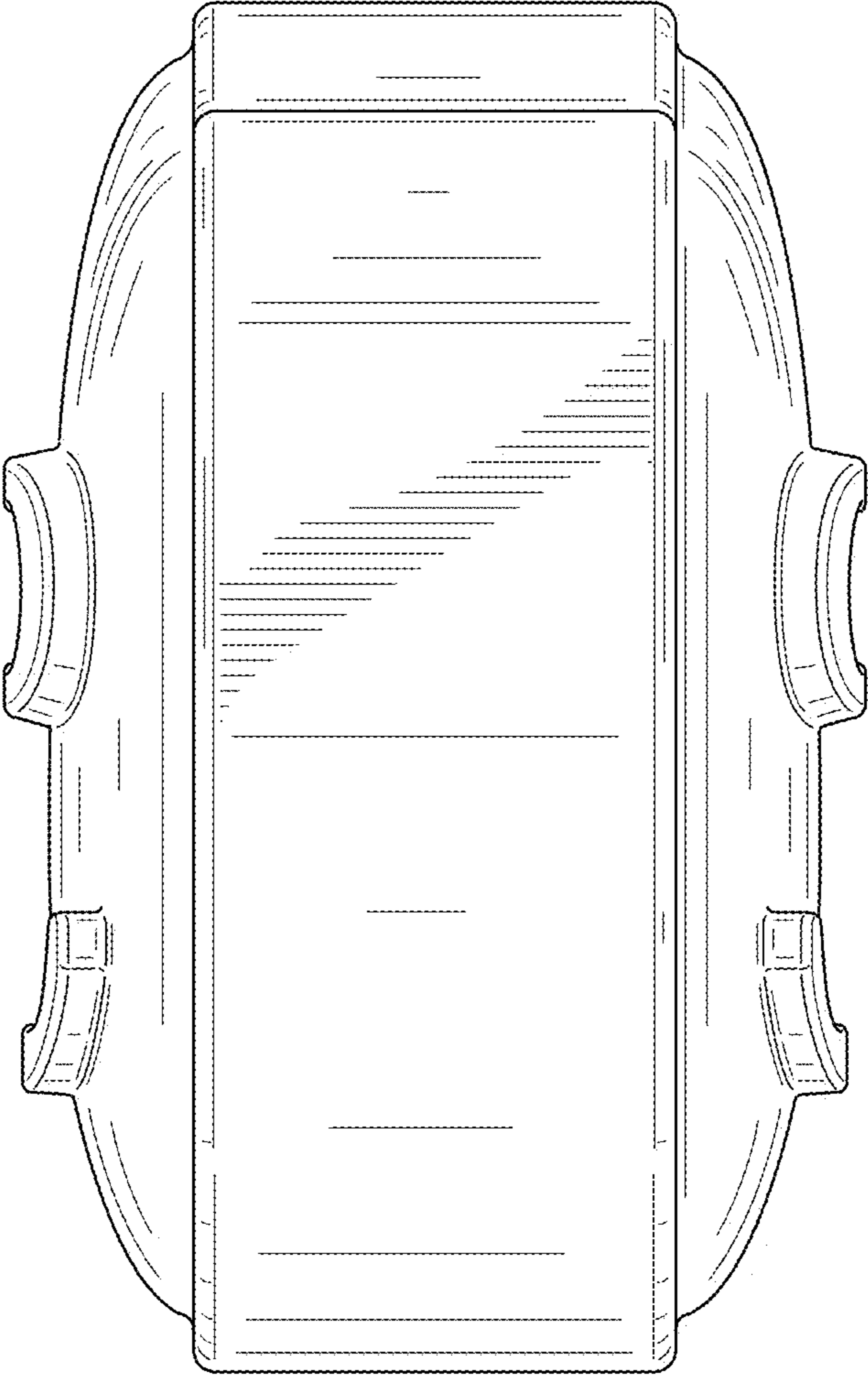

FIG. 5

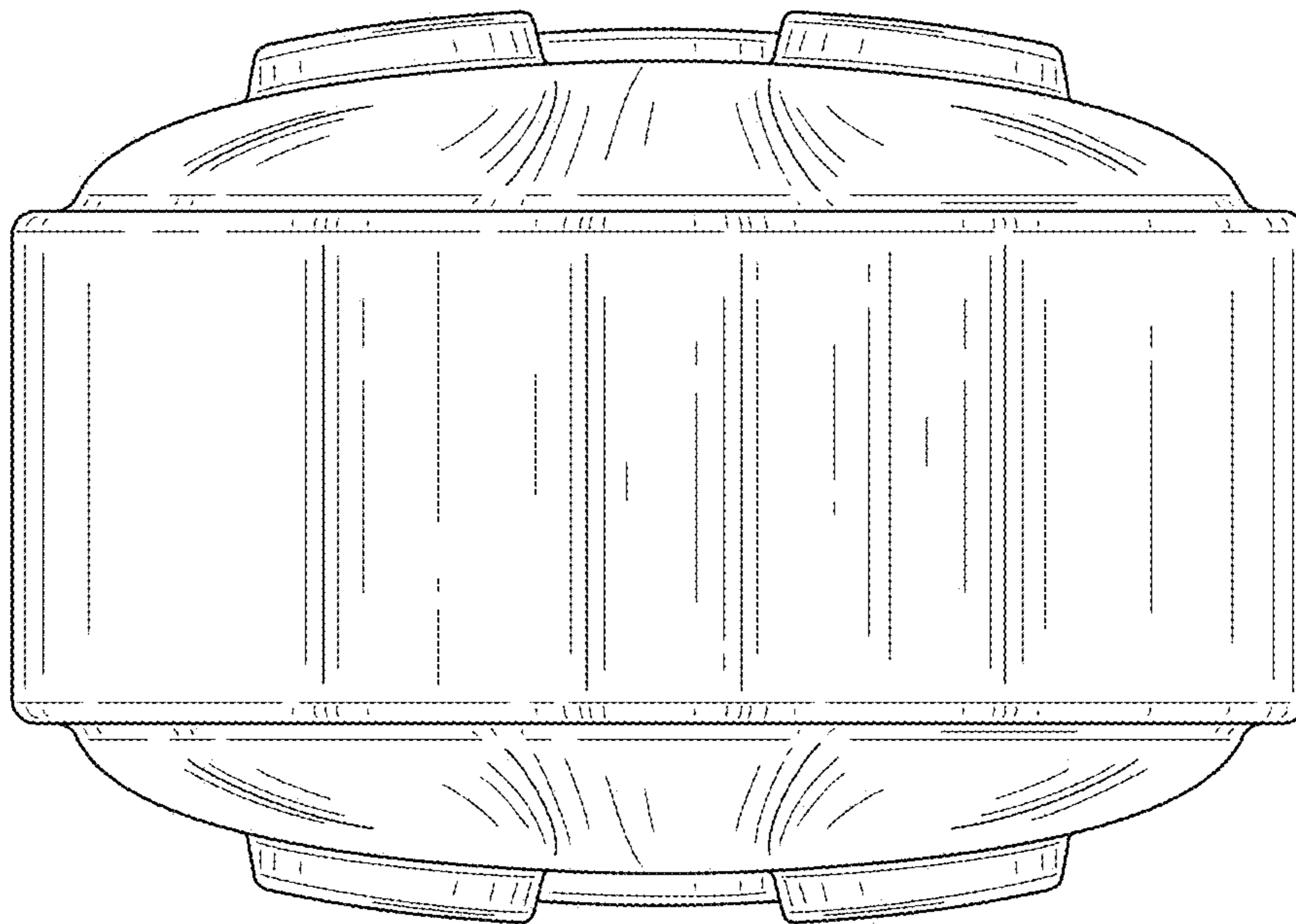

FIG. 6

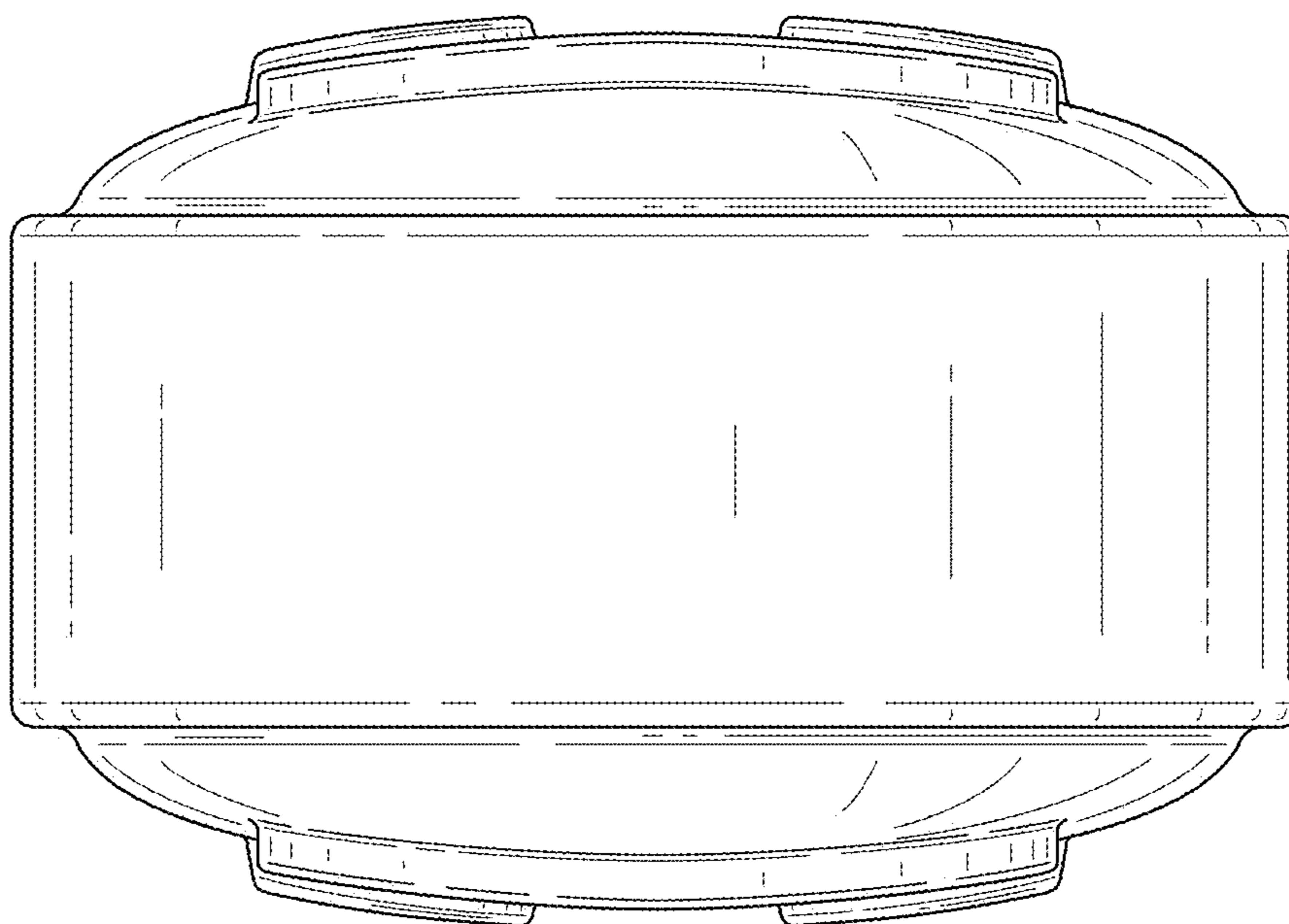

FIG. 7



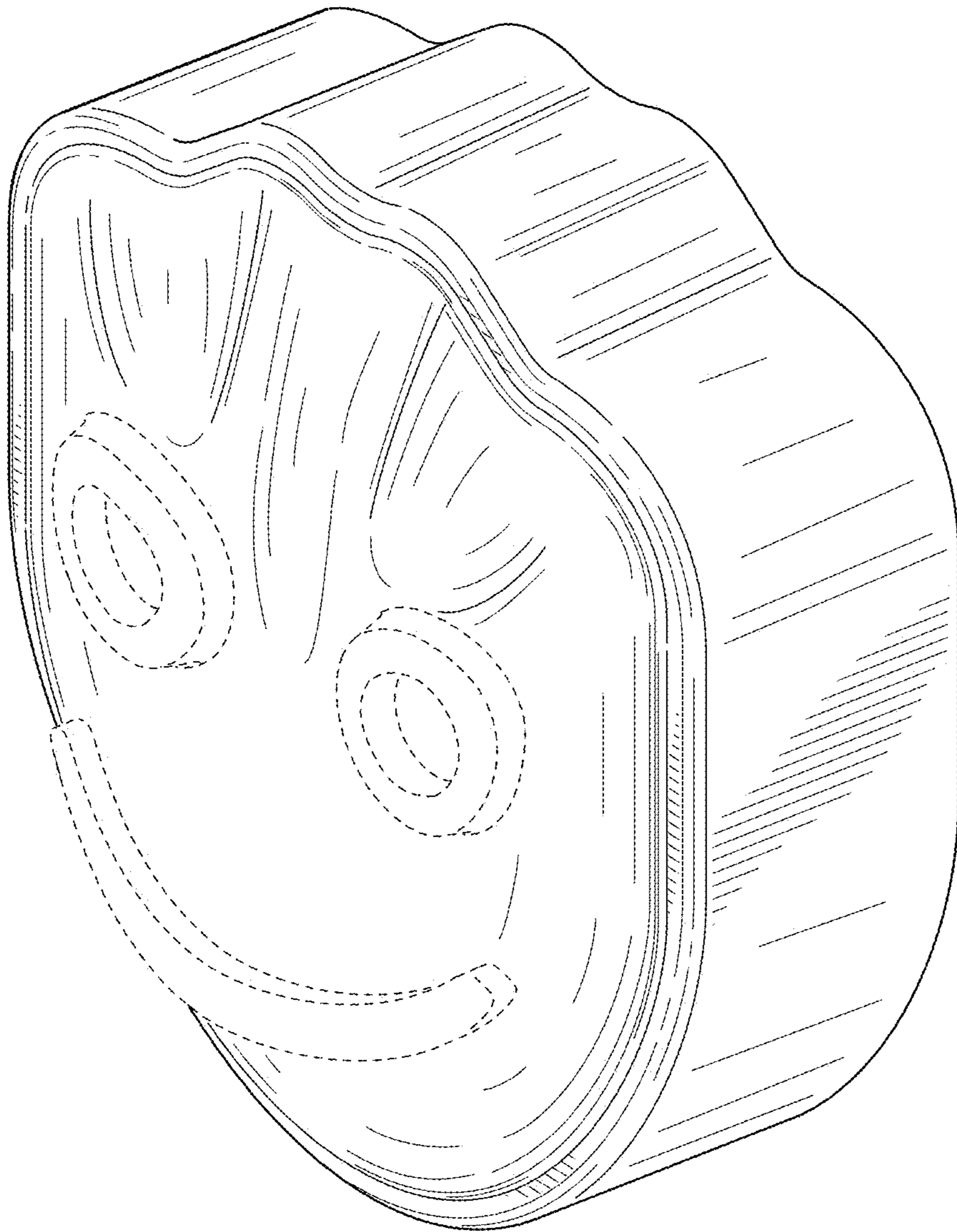

FIG. 8

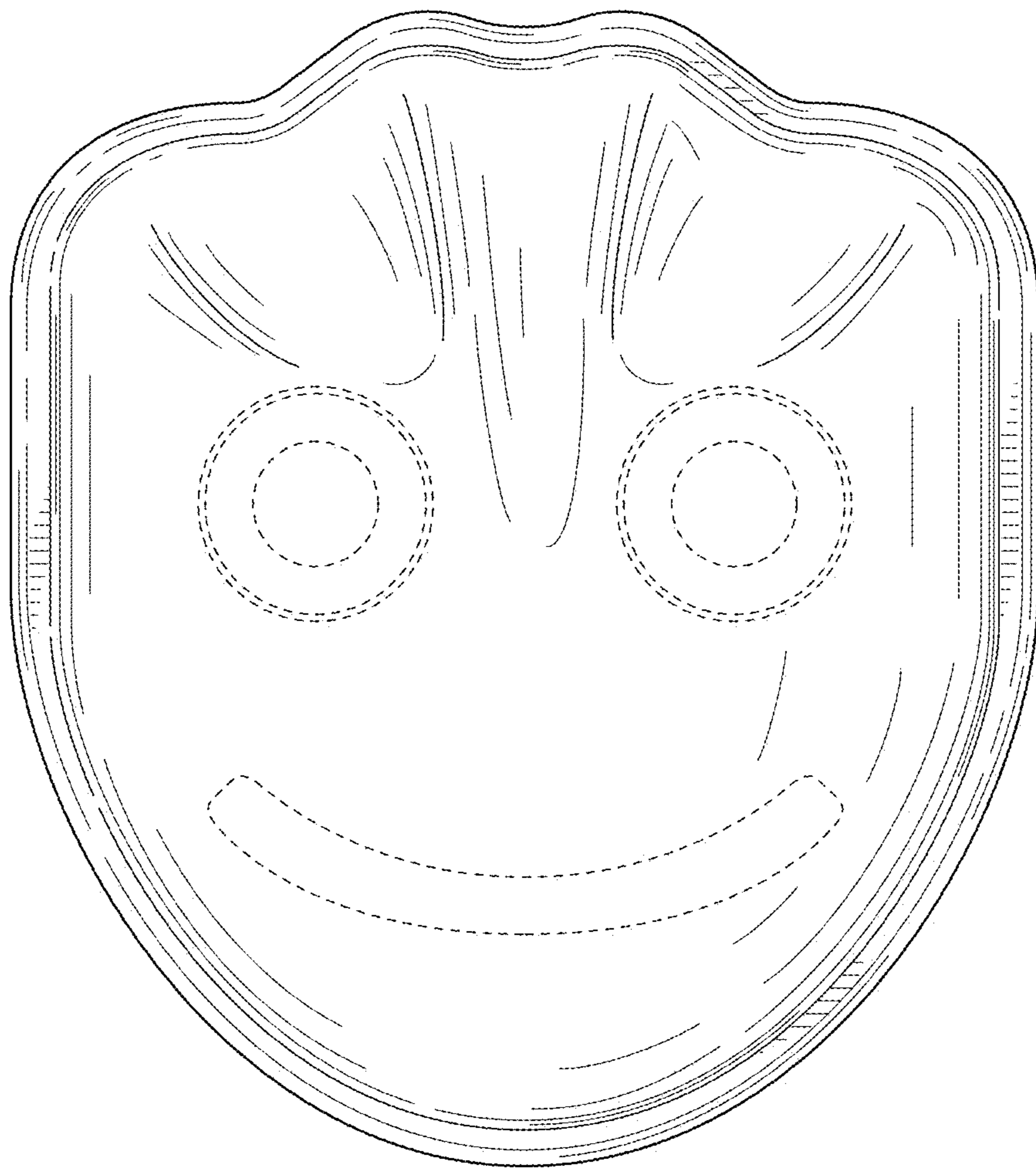

FIG. 9

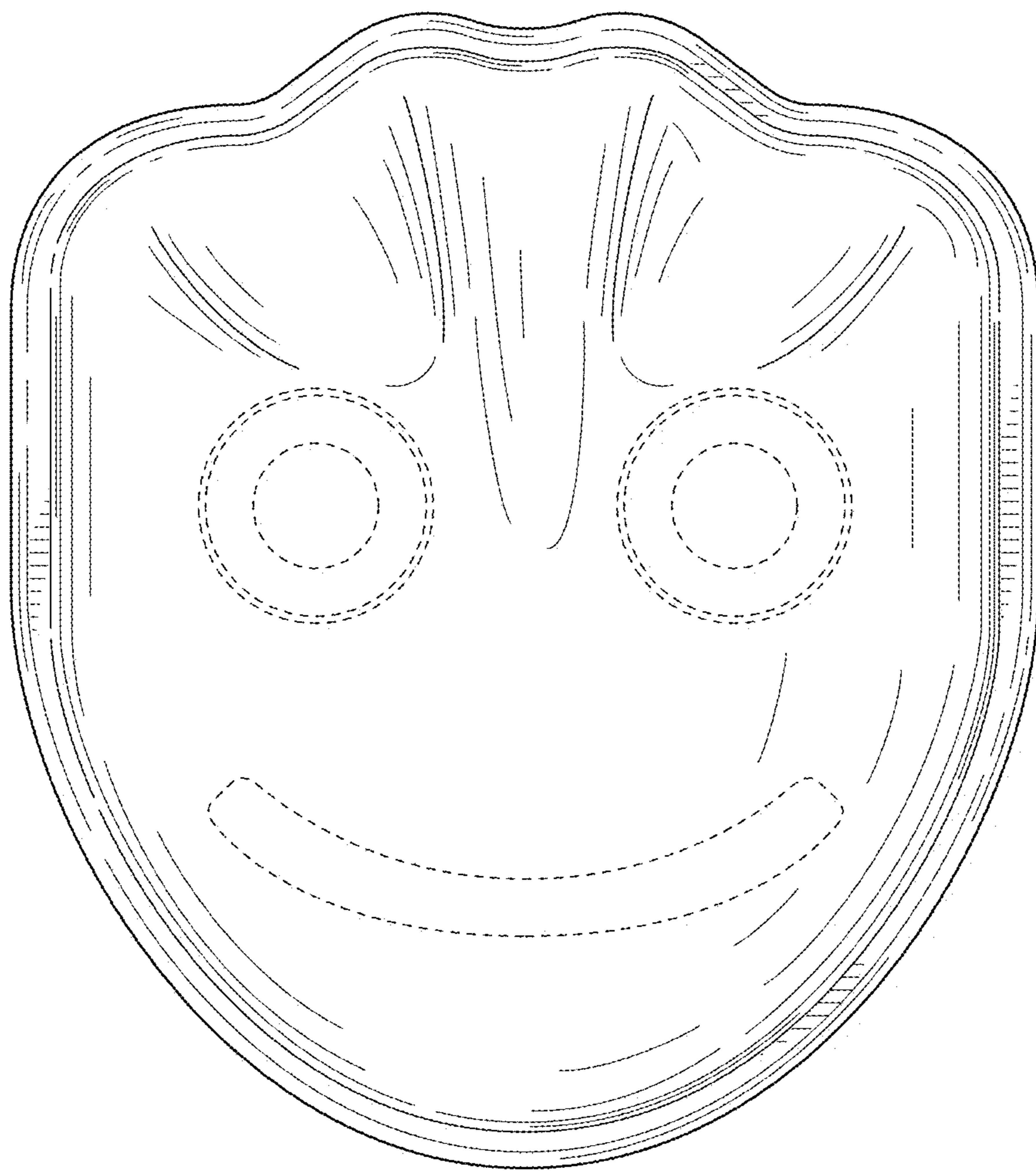

FIG. 10

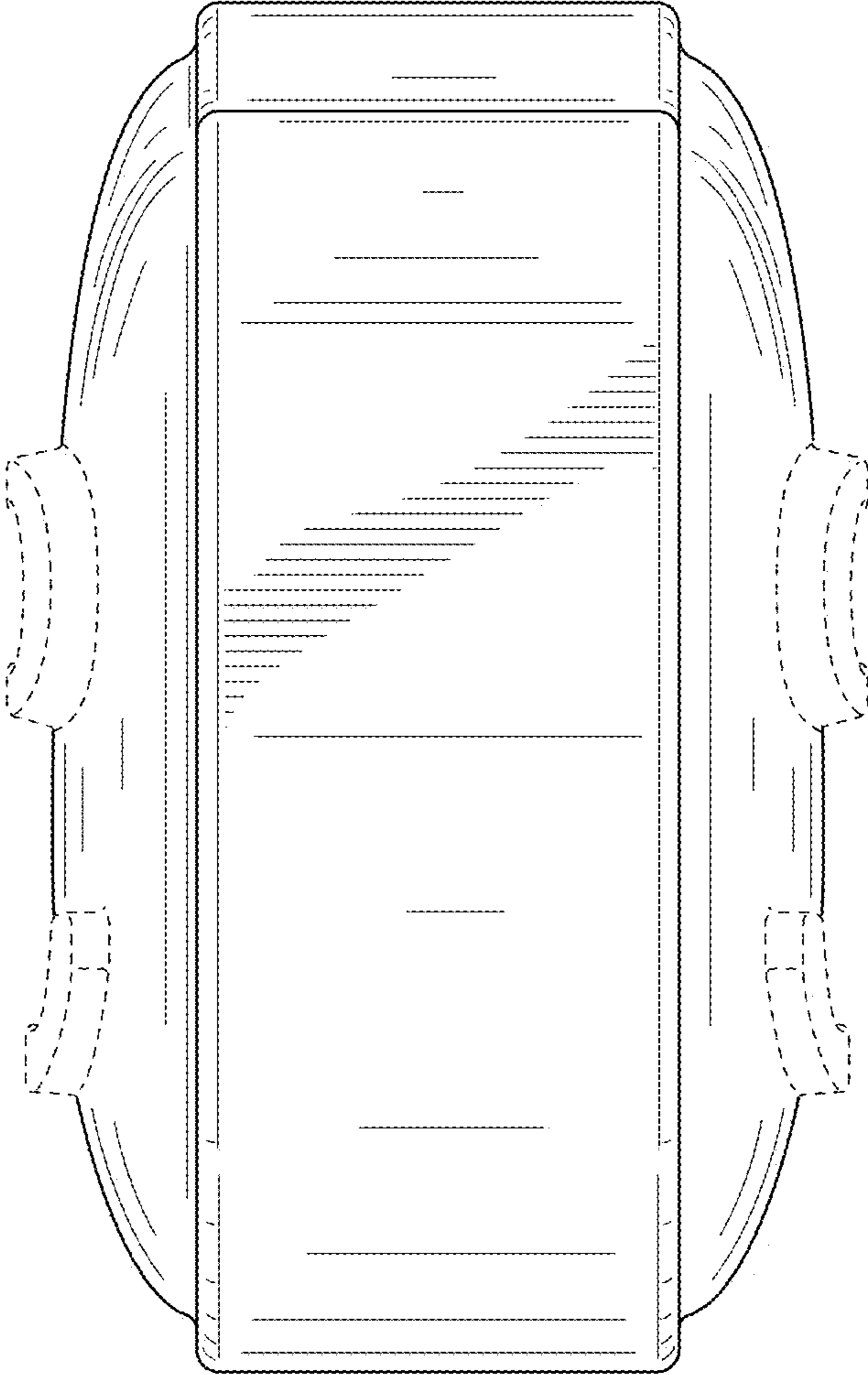

FIG. 11

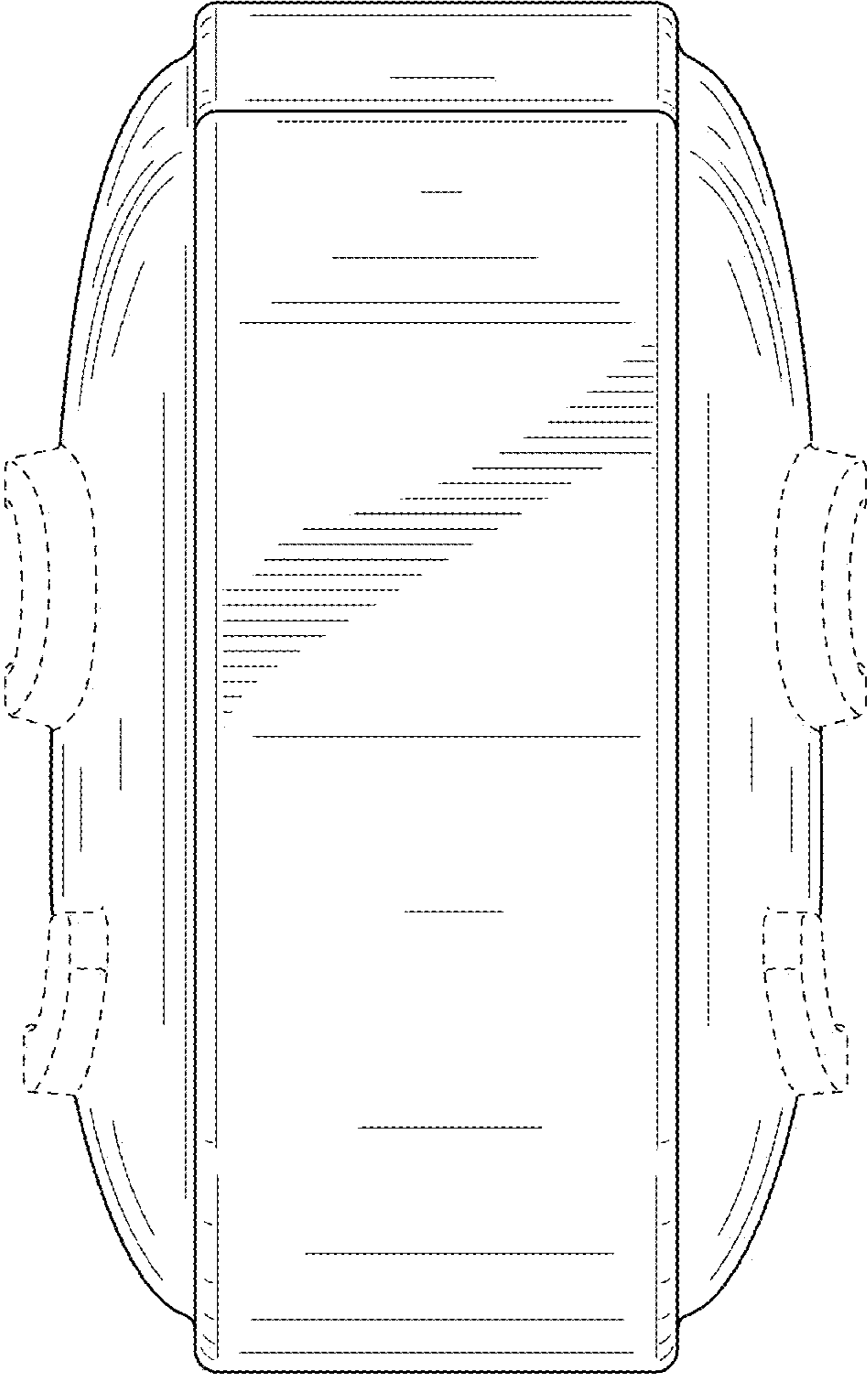

FIG. 12

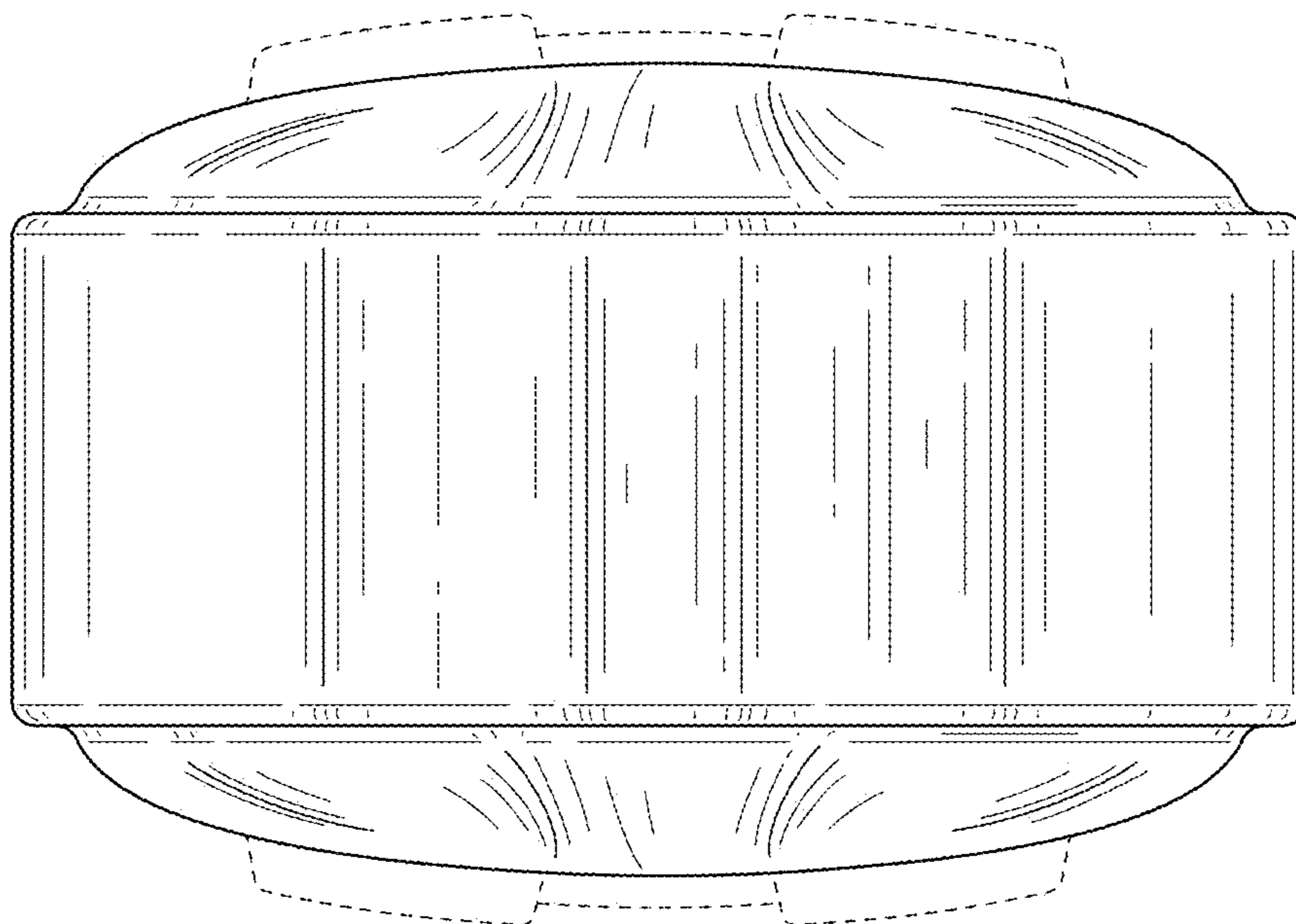

FIG. 13

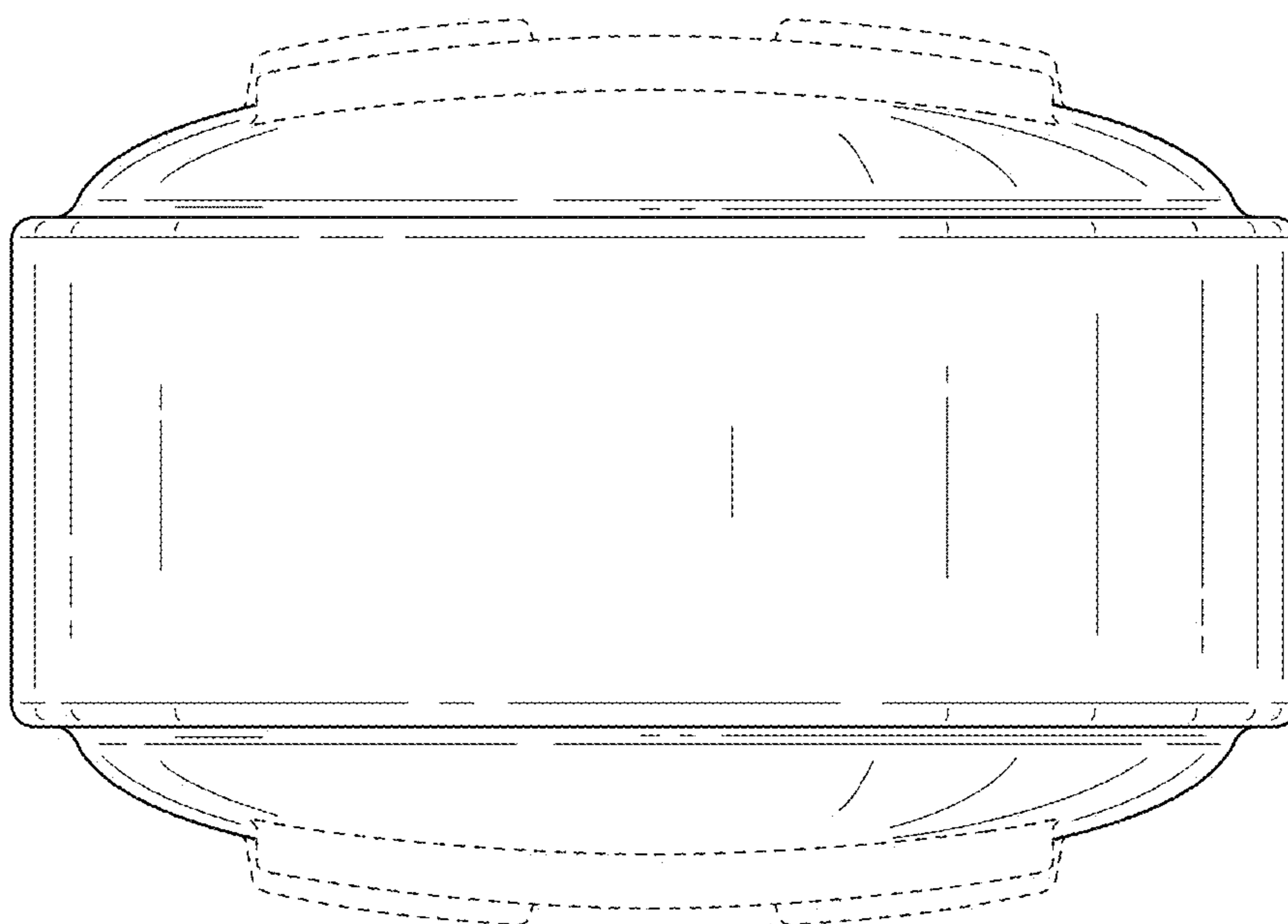

FIG. 14

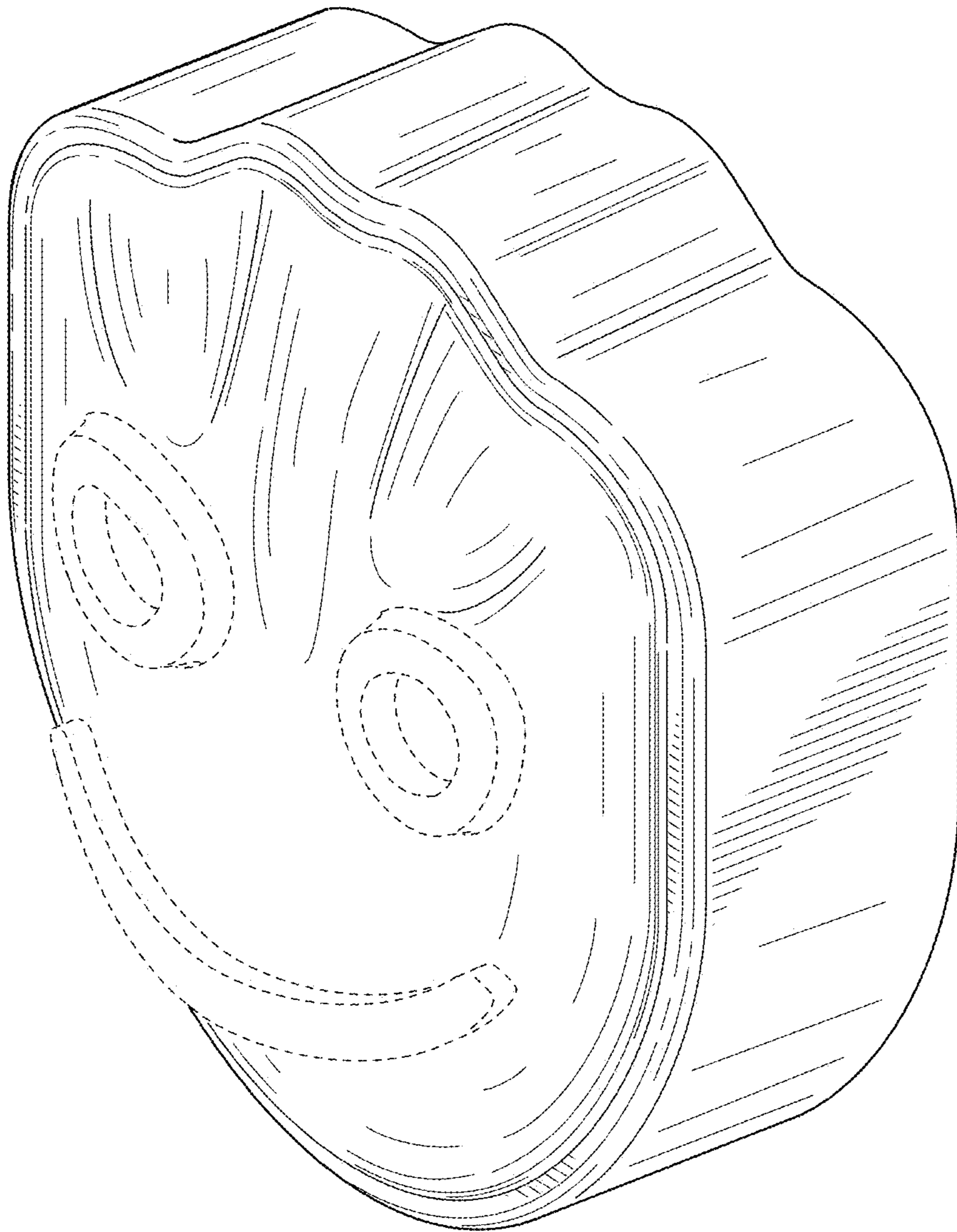

FIG. 15

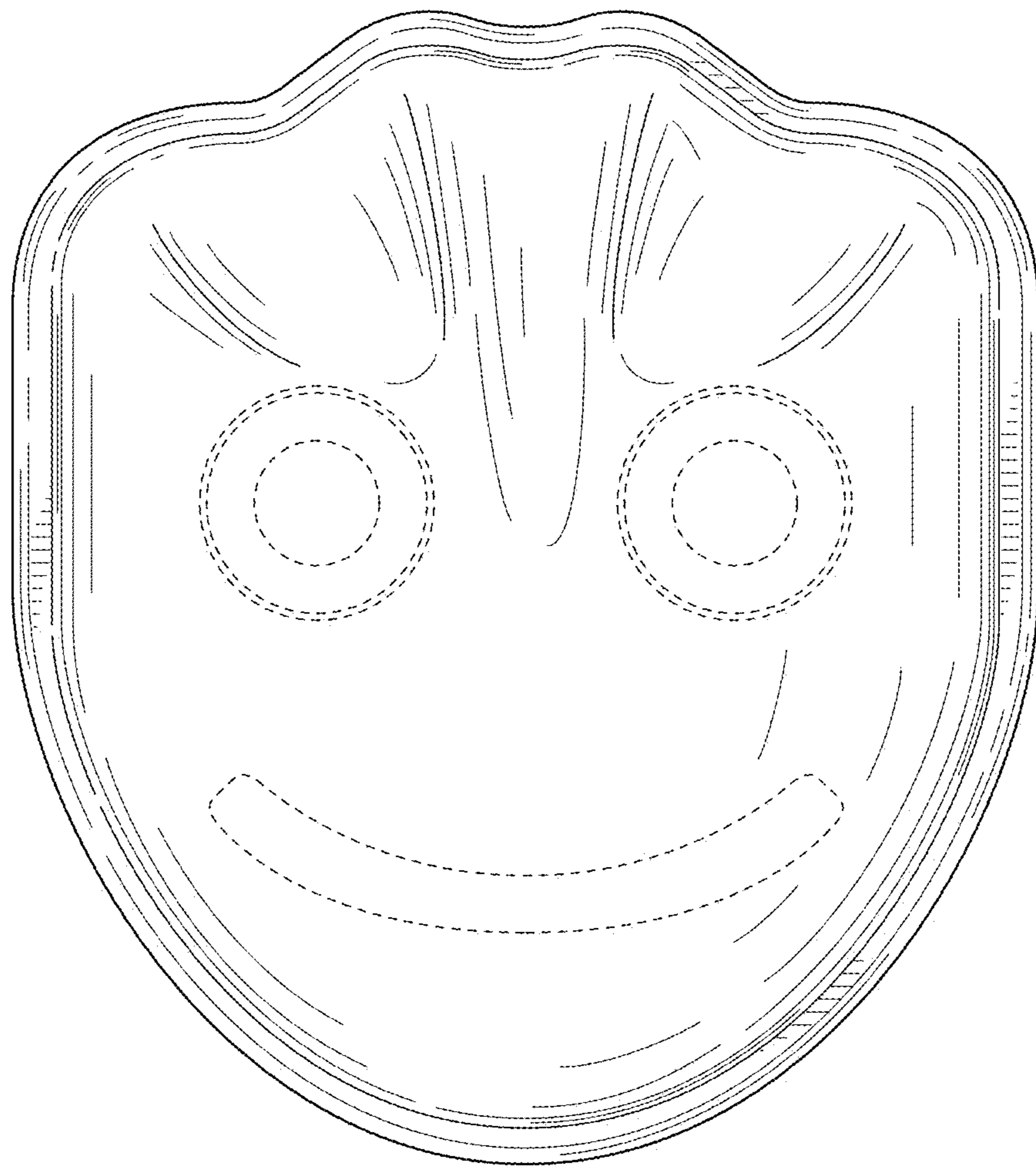

FIG. 16



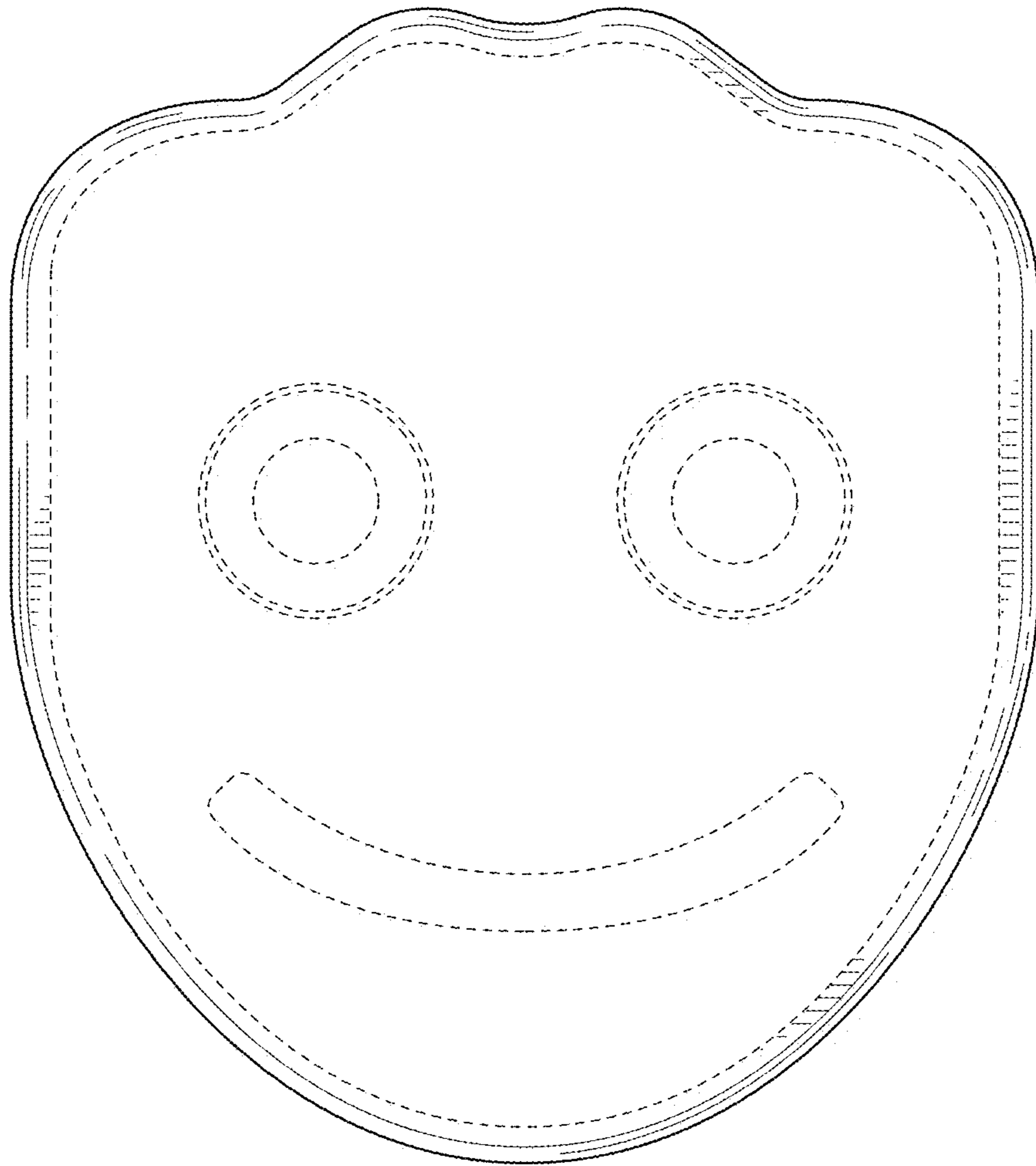

FIG. 17

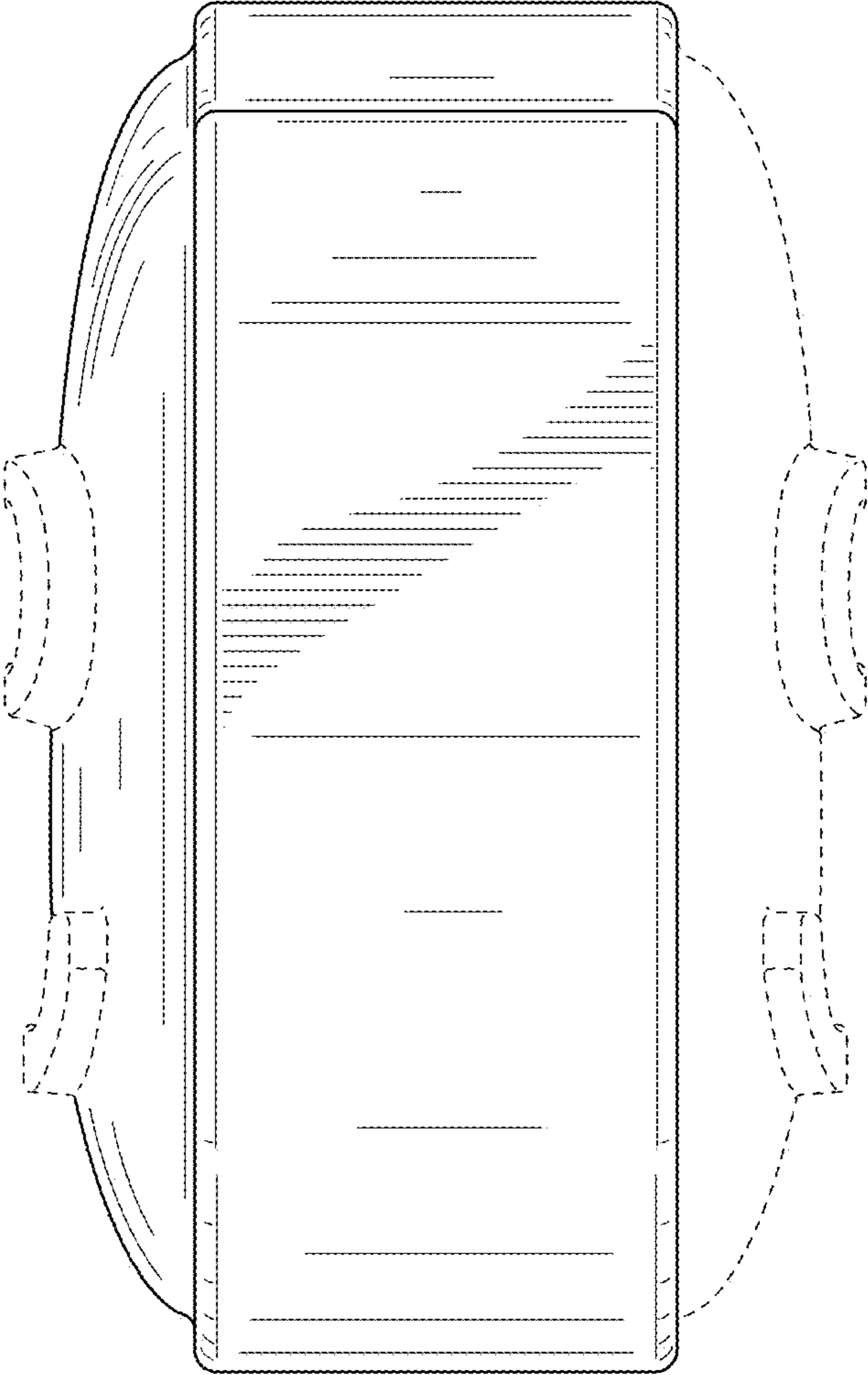

FIG. 18

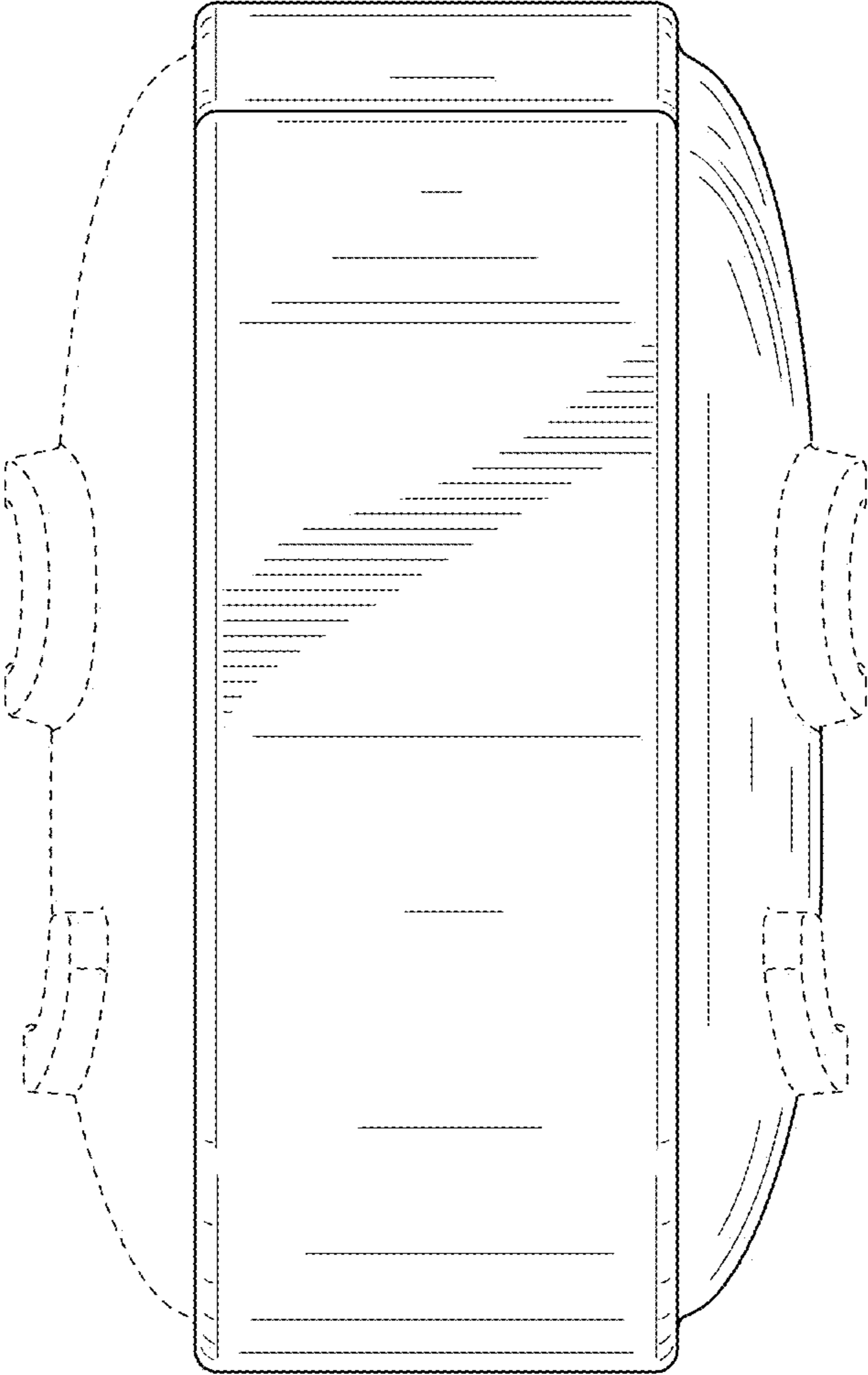

FIG. 19

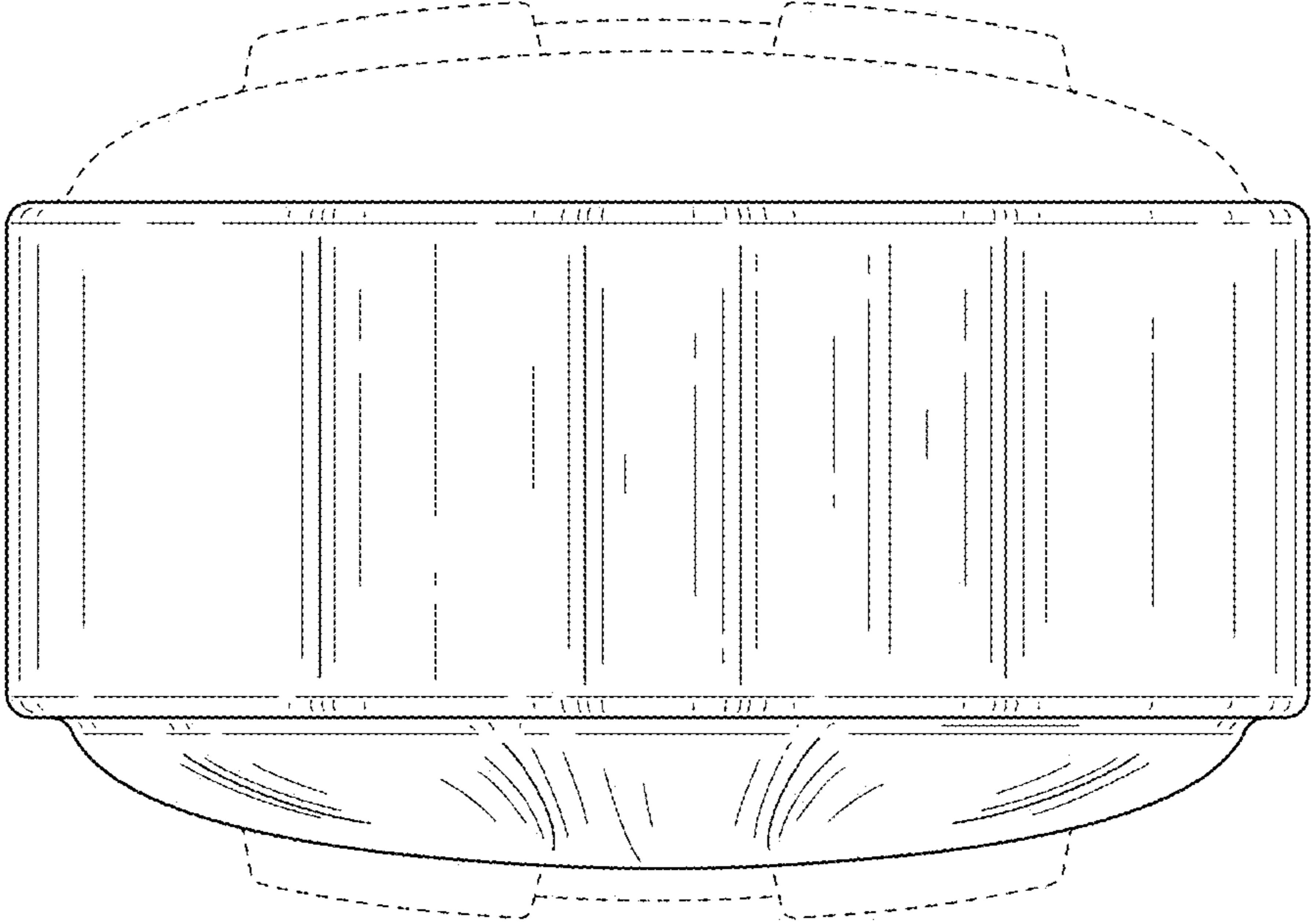

FIG. 20

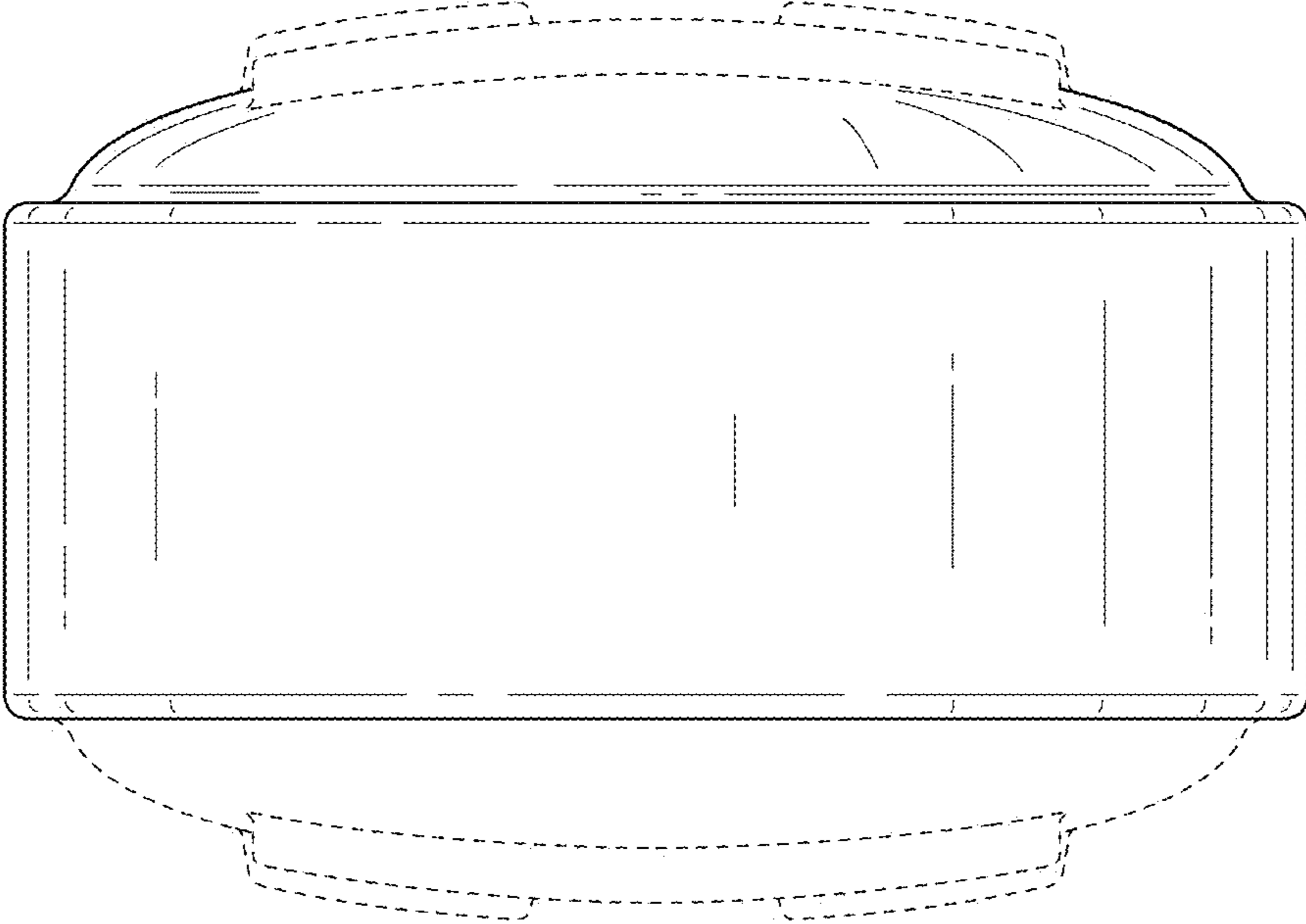

FIG. 21



FIG. 22

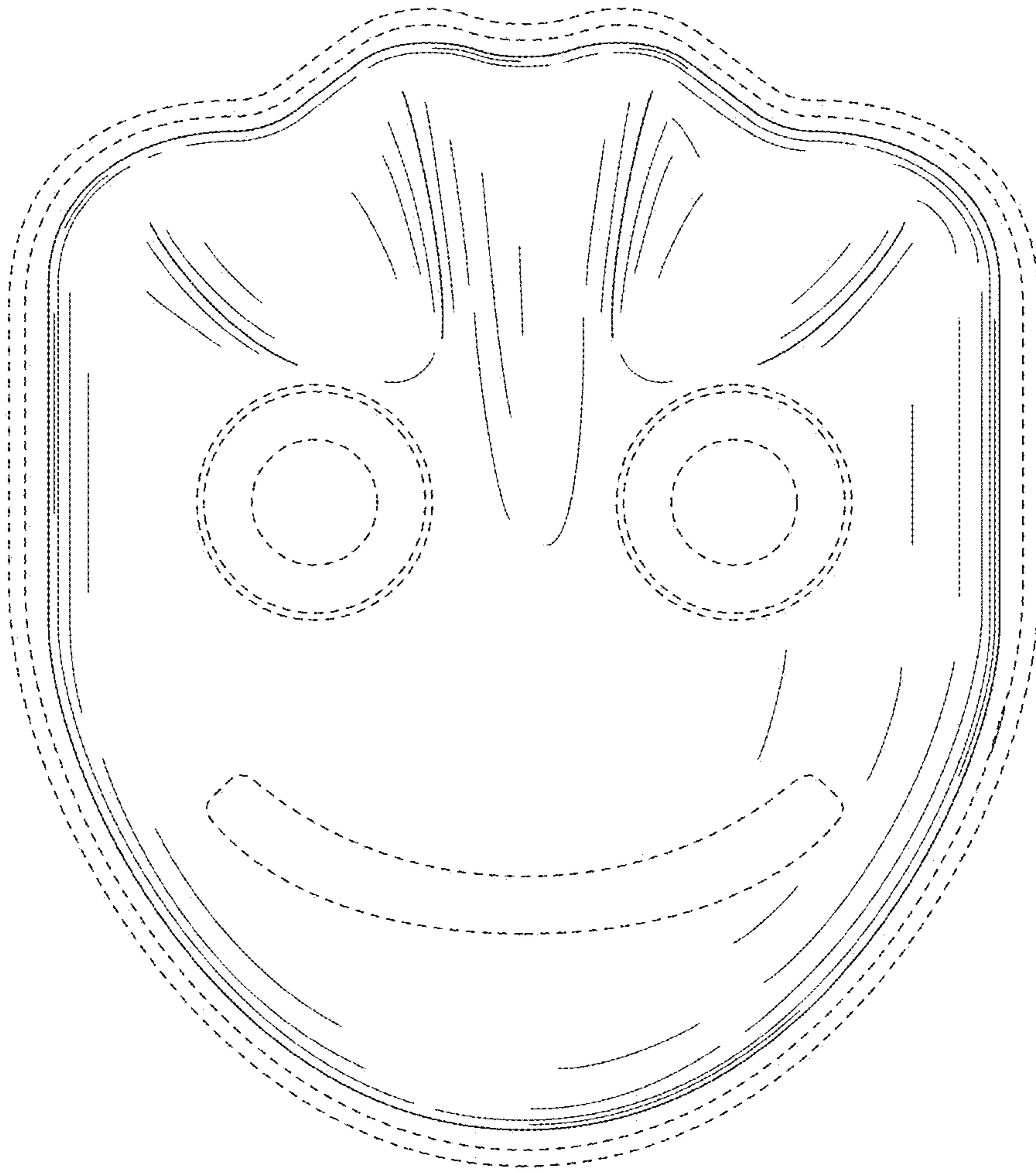

FIG. 23

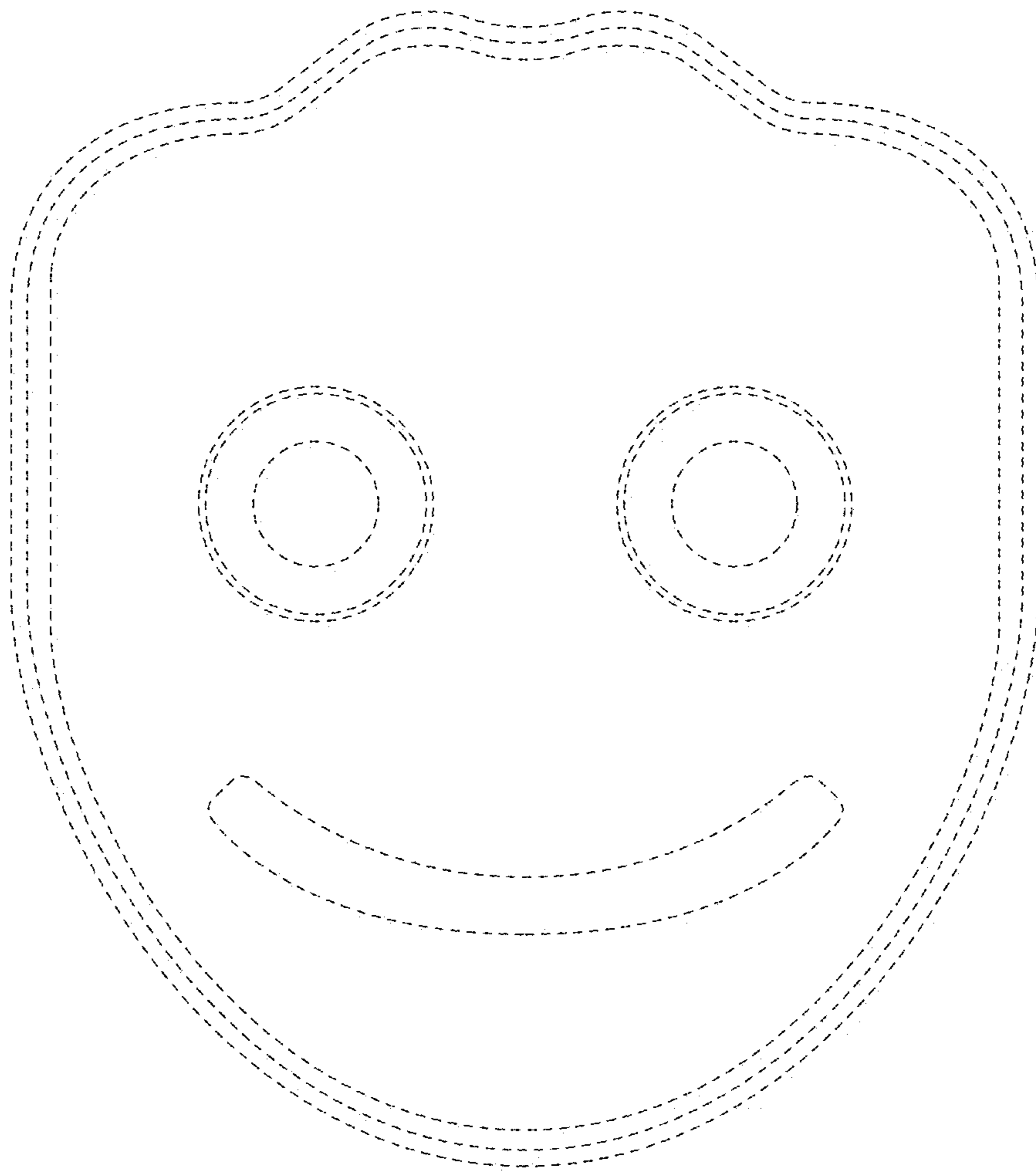

FIG. 24

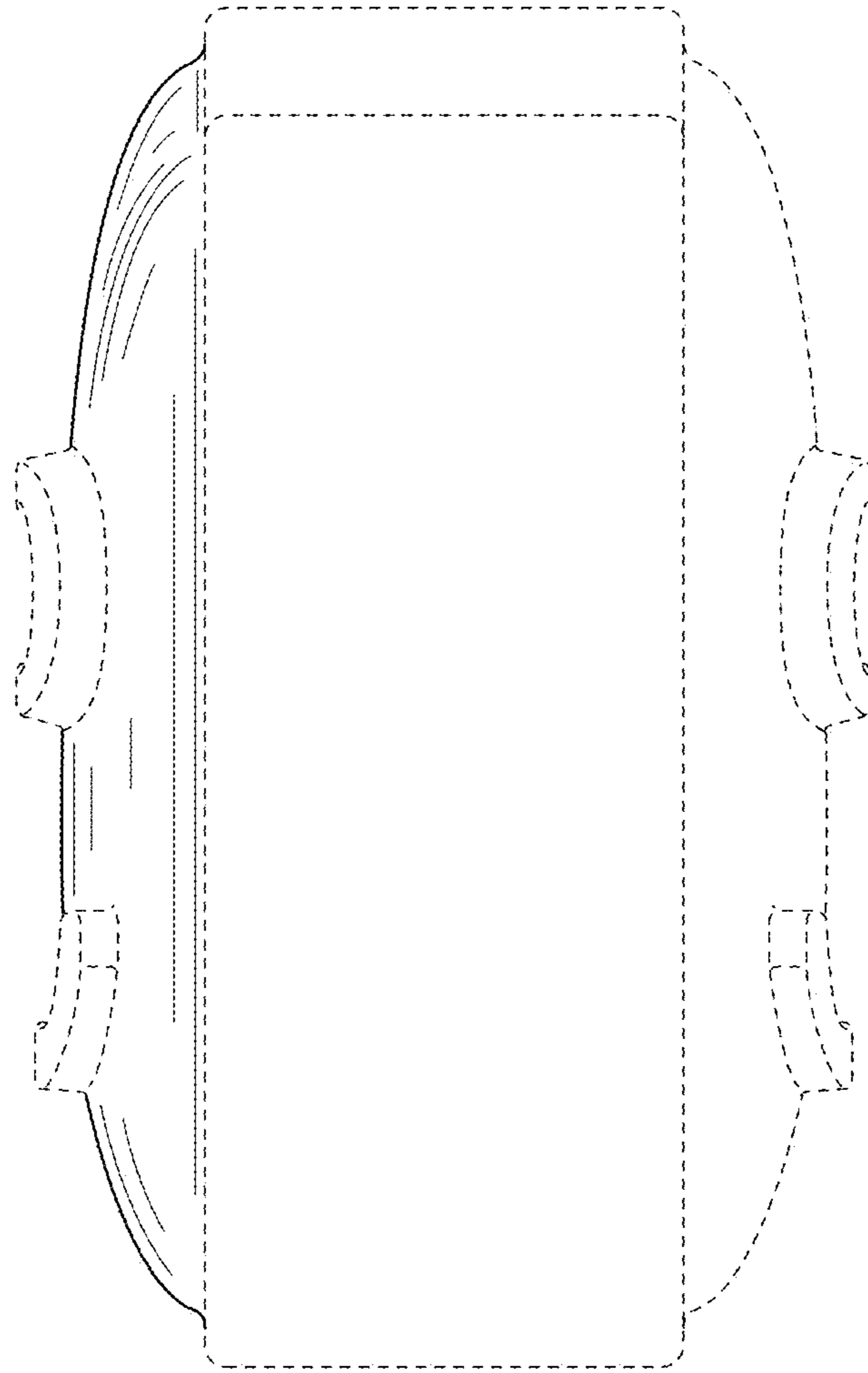

FIG. 25



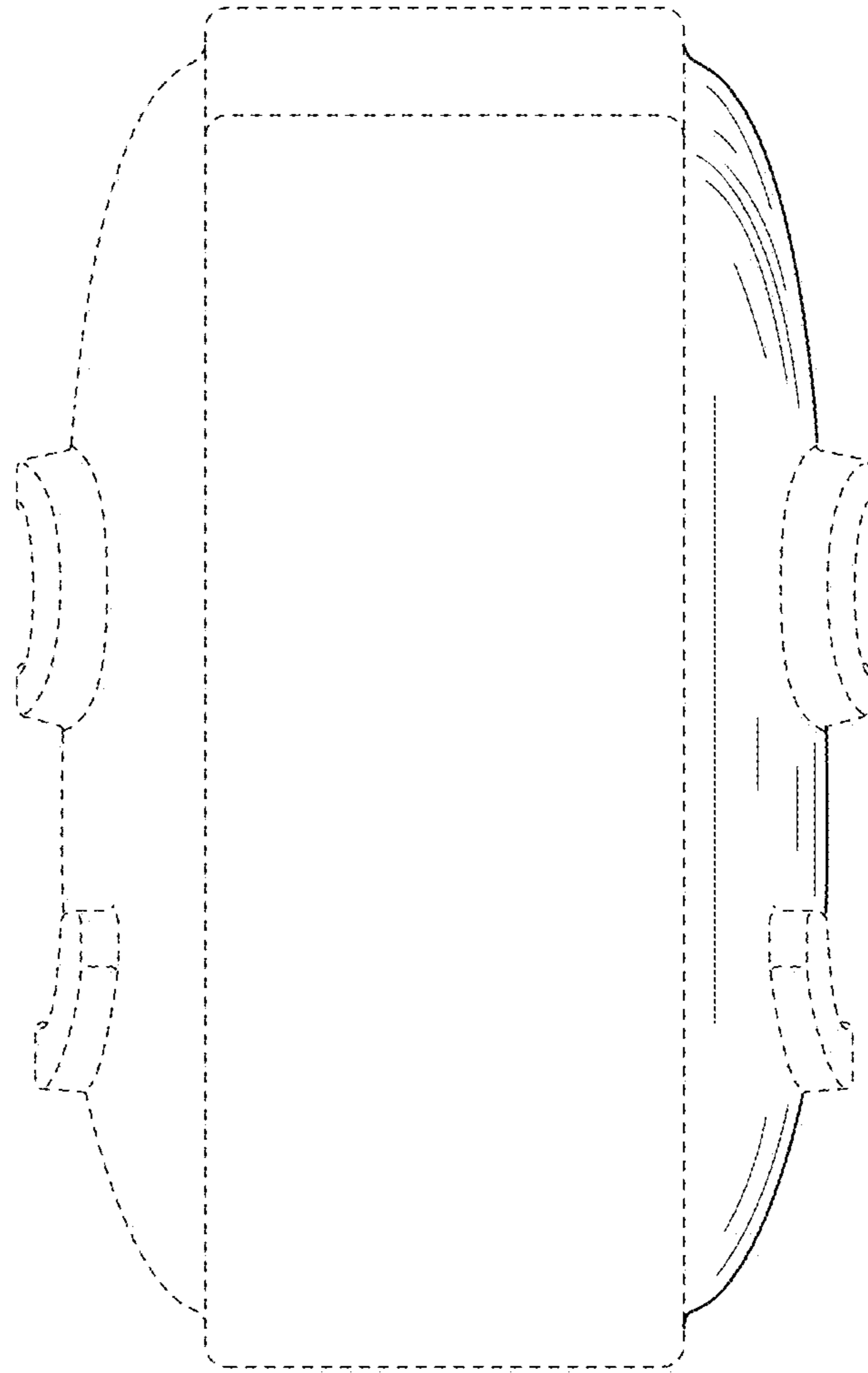

FIG. 26

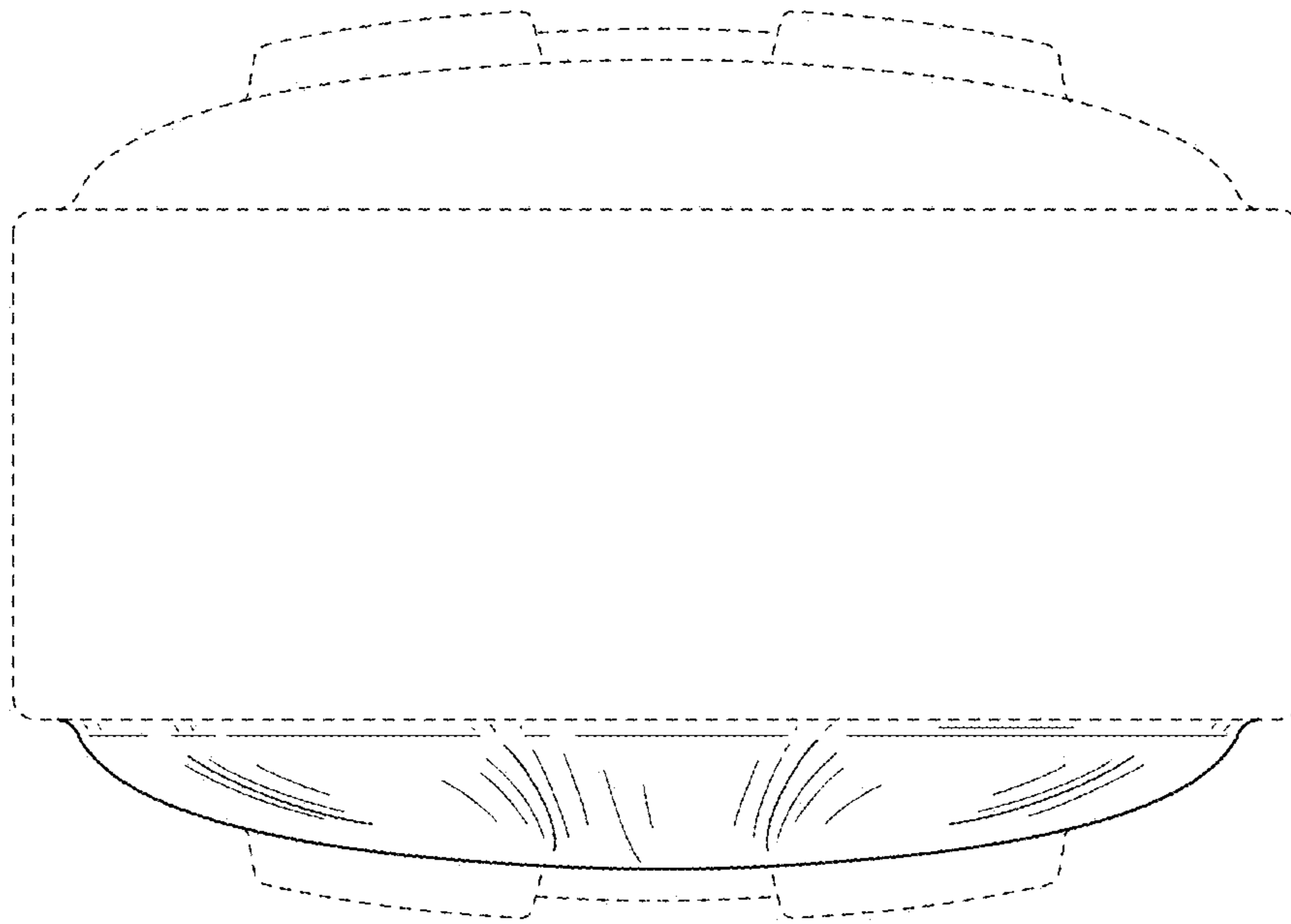

FIG. 27

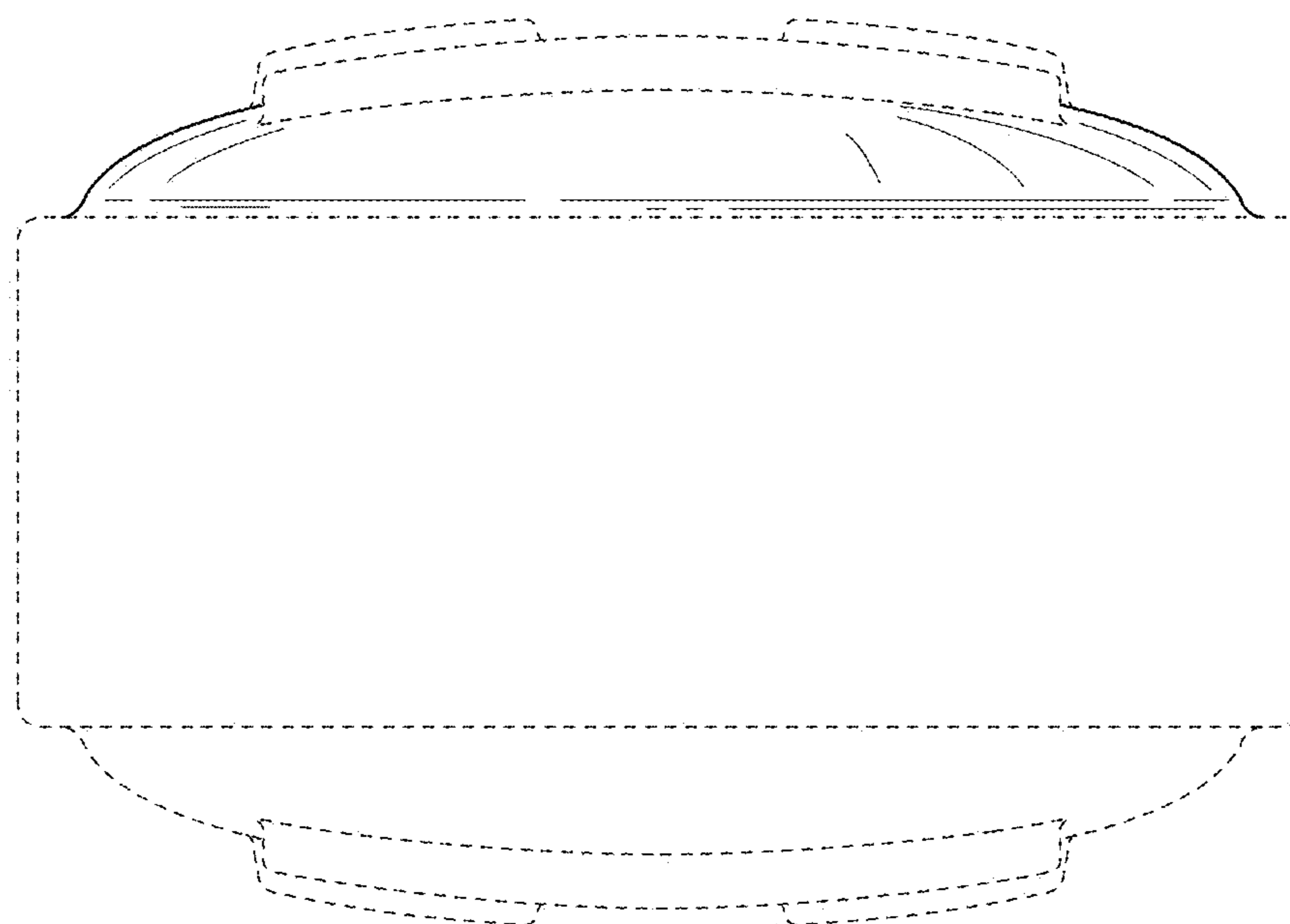

FIG. 28