

US00D947485S

(12) **United States Design Patent**  
**Minzer**

(10) **Patent No.:** **US D947,485 S**  
(45) **Date of Patent:** **\*\* Mar. 29, 2022**

- (54) **URN**
- (71) Applicant: **Marvin Minzer**, Lake Worth, FL (US)
- (72) Inventor: **Marvin Minzer**, Lake Worth, FL (US)
- (\*\*) Term: **15 Years**
- (21) Appl. No.: **29/757,895**
- (22) Filed: **Nov. 10, 2020**
- (51) **LOC (13) Cl.** ..... **99-00**
- (52) **U.S. Cl.**  
USPC ..... **D99/5**
- (58) **Field of Classification Search**  
USPC ..... D99/5, 17, 34; D6/308, 300, 302, 663,  
D6/301; D11/132; D9/663, 456, 414;  
40/124.5, 791, 776, 759, 790, 794, 782,  
40/781; D20/15, 10, 42; 220/4.33, 403;  
428/13; 312/114, 245, 230, 204; 27/1;  
206/783, 497, 765, 771  
CPC ..... A61G 17/08; A61G 17/00; G09F 1/12;  
G09F 19/00  
See application file for complete search history.

(56) **References Cited**

**U.S. PATENT DOCUMENTS**

- 1,325,349 A \* 12/1919 Burgess ..... B65D 9/32  
217/62
- 1,692,999 A \* 11/1928 Siegel ..... G09F 1/12  
40/732

(Continued)

*Primary Examiner* — Paula Allen Greene  
(74) *Attorney, Agent, or Firm* — Daniel S. Polly, P.A.

(57) **CLAIM**

The ornamental design for an urn, as shown and described.

**DESCRIPTION**

FIG. 1 is a front perspective view of an urn showing the new design;

FIG. 2 is a back perspective view thereof;  
 FIG. 3 is a front view thereof;  
 FIG. 4 is a back view thereof;  
 FIG. 5 is a left side view thereof;  
 FIG. 6 is a right side view thereof;  
 FIG. 7 is a top view thereof;  
 FIG. 8 is a bottom view thereof;  
 FIG. 9 is a back perspective view of a second embodiment of FIG. 1 thereof, the only difference being the text on the back removed;  
 FIG. 10 is a back view thereof;  
 FIG. 11 is a back perspective view in an alternate position thereof;  
 FIG. 12 is a left side view of FIG. 11 thereof;  
 FIG. 13 is a front perspective view thereof, the only difference being the unclaimed top opening in unclaimed broken lines;  
 FIG. 14 is a left side view thereof;  
 FIG. 15 is a perspective view thereof in an alternate position;  
 FIG. 16 is a perspective view thereof in an alternate position;  
 FIG. 17 is a perspective view thereof;  
 FIG. 18 is a front perspective view of FIG. 1 thereof;  
 FIG. 19 is a back perspective view thereof, the only difference being the unclaimed broken lines;  
 FIG. 20 is a front view thereof;  
 FIG. 21 is a back view of FIG. 19 thereof;  
 FIG. 22 is a left side view thereof;  
 FIG. 23 is a right side view thereof;  
 FIG. 24 is a top view thereof; and,  
 FIG. 25 is a bottom view thereof.

The broken lines in FIGS. 1, 3, 13, 15, 16, 17, 18, and 20 is a representation of a human form that forms no part of the claimed design. The broken lines in FIGS. 1 through 25 to environment forms no part of the claimed design.

**1 Claim, 18 Drawing Sheets**

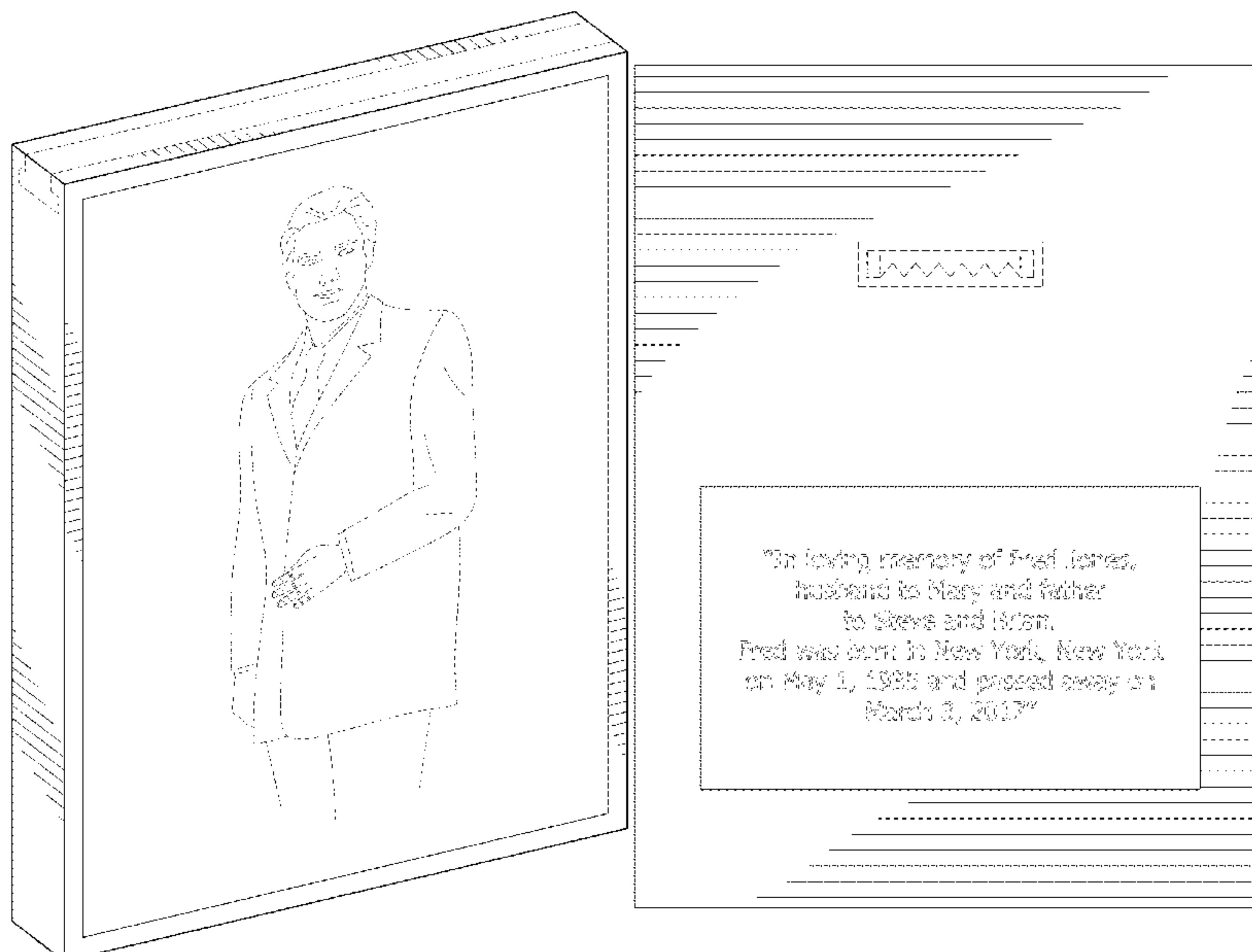

# US D947,485 S

Page 2

(56)

## References Cited

### U.S. PATENT DOCUMENTS

1,782,120 A *	11/1930	Funke	B65D 5/4204	5,353,536 A *	10/1994	Erber	G09F 15/0012
			206/771				40/606.09
1,895,938 A *	1/1933	Mutschler	G09F 1/12	5,421,111 A *	6/1995	Primm	A47G 1/06
			40/611.02				40/721
1,965,830 A *	7/1934	Hammer	H04R 1/023	D370,568 S *	6/1996	Wynne	D6/303
			181/199	D374,963 S *	10/1996	Neuberger	D99/5
2,747,311 A *	5/1956	Fulmer	G09F 1/10	D384,304 S *	9/1997	Sheldon	D11/132
			40/781	D389,323 S *	1/1998	Buchert	D6/300
2,833,069 A *	5/1958	Cairns	G09F 13/0413	D392,112 S *	3/1998	Cynkar	D6/300
			40/574	5,740,637 A *	4/1998	Snow	E04H 13/006
2,900,750 A *	8/1959	Buelow	A47G 1/0655				27/1
			40/790	5,758,396 A *	6/1998	Jeon	G02B 26/0858
2,980,309 A *	4/1961	Papas	A47G 1/12				29/25.35
			206/783	5,787,625 A *	8/1998	Yesbick	G09F 15/0006
3,312,337 A *	4/1967	Martin	B65D 75/004				40/124.5
			206/497	D401,766 S *	12/1998	Fry	D6/302
3,553,872 A *	1/1971	Ebner	G09F 1/12	D405,473 S *	2/1999	Tikhonski	D20/10
			40/711	5,950,288 A *	9/1999	Bach Lahor	A61G 17/007
3,648,393 A *	3/1972	Parrilla	A47G 1/065				27/1
			40/730	D431,374 S *	10/2000	Glover	D6/300
3,681,867 A *	8/1972	Bilodeau	A47G 1/06	6,285,770 B1 *	9/2001	Azi	B42D 15/022
			40/759				381/152
3,751,838 A *	8/1973	Wiener, Jr.	A47G 1/06	D451,683 S *	12/2001	Vincent	D6/300
			40/790	D453,191 S *	1/2002	Gentelia	D20/10
3,771,244 A *	11/1973	Ebner	A47G 1/06	6,665,916 B1 *	12/2003	Santorello	A61G 17/08
			40/721				27/1
3,782,015 A *	1/1974	Esry	G09F 1/12	D492,079 S *	6/2004	Feltman	D99/5
			40/781	7,008,029 B1 *	3/2006	Aclin	A45C 11/16
3,811,214 A *	5/1974	Tate	A47G 1/0605				206/566
			40/782	7,082,653 B1 *	8/2006	Sueppel	A47G 1/0616
3,996,682 A *	12/1976	Schwartz	A47G 1/0605				27/1
			40/794	D559,557 S *	1/2008	Mischel, Jr.	D6/300
4,041,630 A *	8/1977	Holbrook	G09F 1/12	D569,575 S *	5/2008	Yalinkaya	D99/34
			40/765	7,387,151 B1 *	6/2008	Payne	E06B 5/006
4,149,331 A *	4/1979	Prager	A47G 1/06				160/371
			40/766	D642,385 S *	8/2011	Lee	D6/308
D254,643 S *	4/1980	Ashenfarb	D6/308	D654,703 S *	2/2012	LeMay	D6/300
4,304,447 A *	12/1981	Ellwood	A45C 11/16	D687,321 S *	8/2013	Pralus	D9/759
			312/204	8,770,416 B1 *	7/2014	Guida	A47B 95/008
4,356,650 A *	11/1982	Antonczyk	B44C 5/02				211/10
			40/782	D710,702 S *	8/2014	Damatov	D9/456
D268,374 S *	3/1983	Dereks	D9/414	D721,893 S *	2/2015	Gorham	D6/300
4,402,398 A *	9/1983	Smoczynski	B42F 5/00	D728,977 S *	5/2015	Wittenberg	A47G 1/02
			206/0.82				D6/663
D271,168 S *	11/1983	Antonczyk	D6/300	D742,651 S *	11/2015	Sands	D6/301
4,413,736 A *	11/1983	Nibling	A47F 7/02	D748,363 S *	1/2016	Hackett	D99/5
			206/457	D752,313 S *	3/2016	Hackett	D99/5
4,546,019 A *	10/1985	Schneider	B44F 7/00	D785,987 S *	5/2017	Price	D6/691
			40/582	D796,233 S *	9/2017	Pauley	D6/663
4,777,746 A *	10/1988	Brooks	A47G 1/0633	D796,339 S *	9/2017	Pauley	D9/663
			40/748	D804,194 S *	12/2017	Thams	D6/300
4,831,754 A *	5/1989	Tallent	A47F 3/002	2001/0040423 A1 *	11/2001	Sheehan	A47G 1/06
			40/800				312/245
D309,921 S *	8/1990	Leo, Sr.	D20/42	2004/0134111 A1 *	7/2004	Berg	A47G 1/06
5,205,059 A *	4/1993	Doll	A47G 1/06				40/721
			40/718	2004/0226210 A1 *	11/2004	Kaur	G09F 23/00
5,230,127 A *	7/1993	Zukowski	A61G 17/0106				40/725
			27/1	2008/0010792 A1 *	1/2008	Pryd-Kakuk	A61G 17/08
							27/1
				2009/0071052 A1 *	3/2009	Craig	A47G 1/065
							40/791

\* cited by examiner

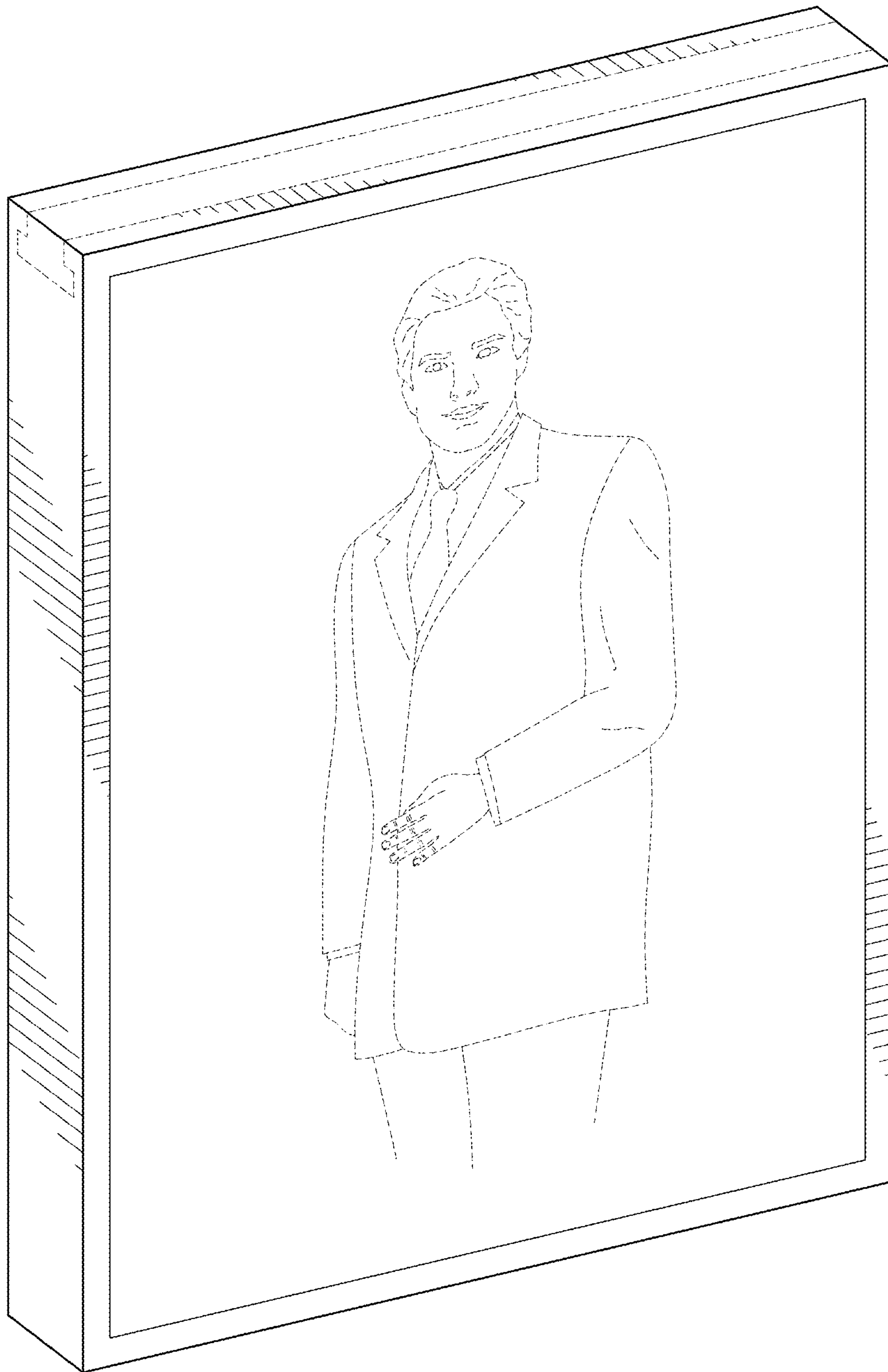

FIG. 1



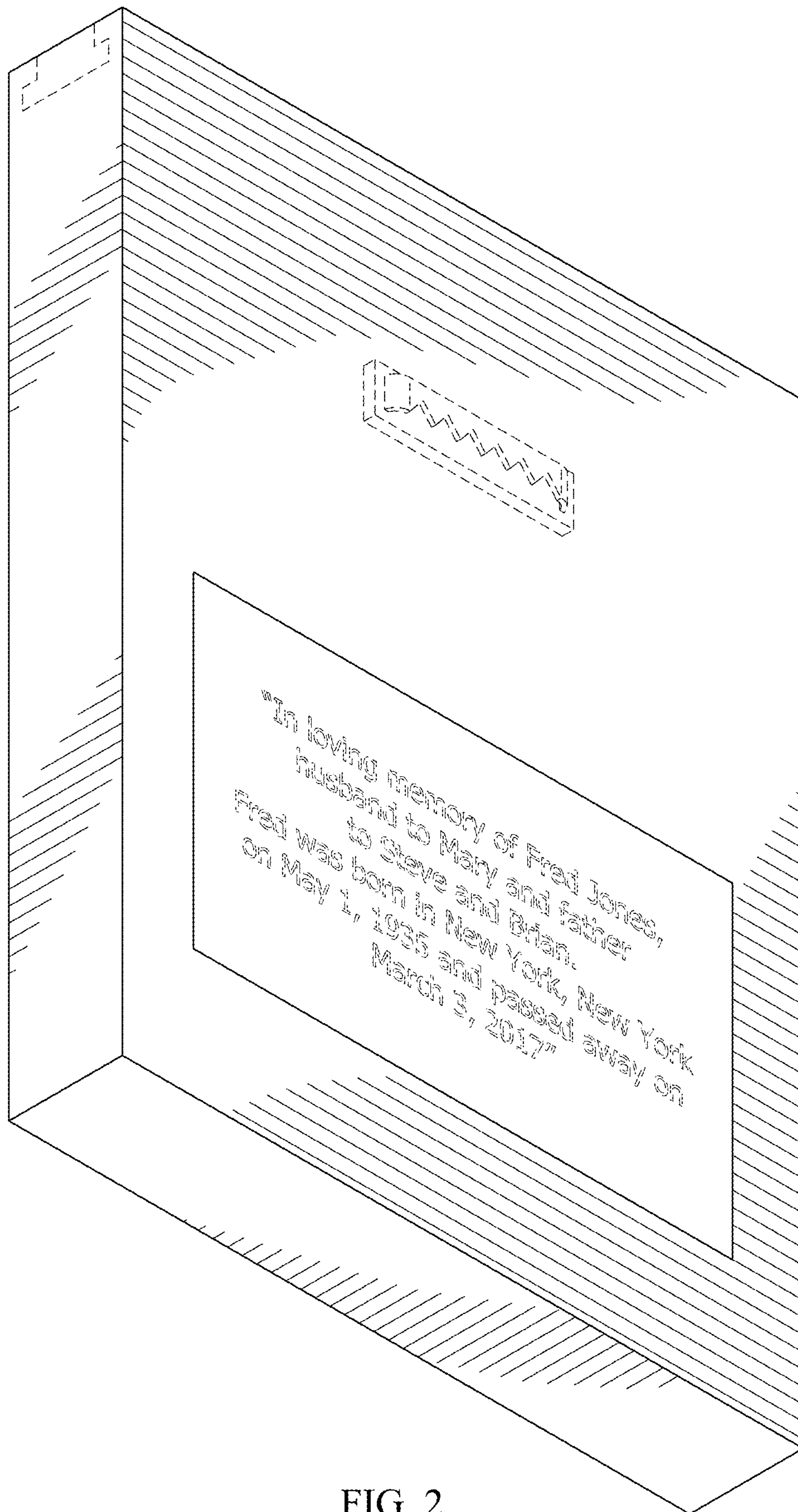

FIG. 2

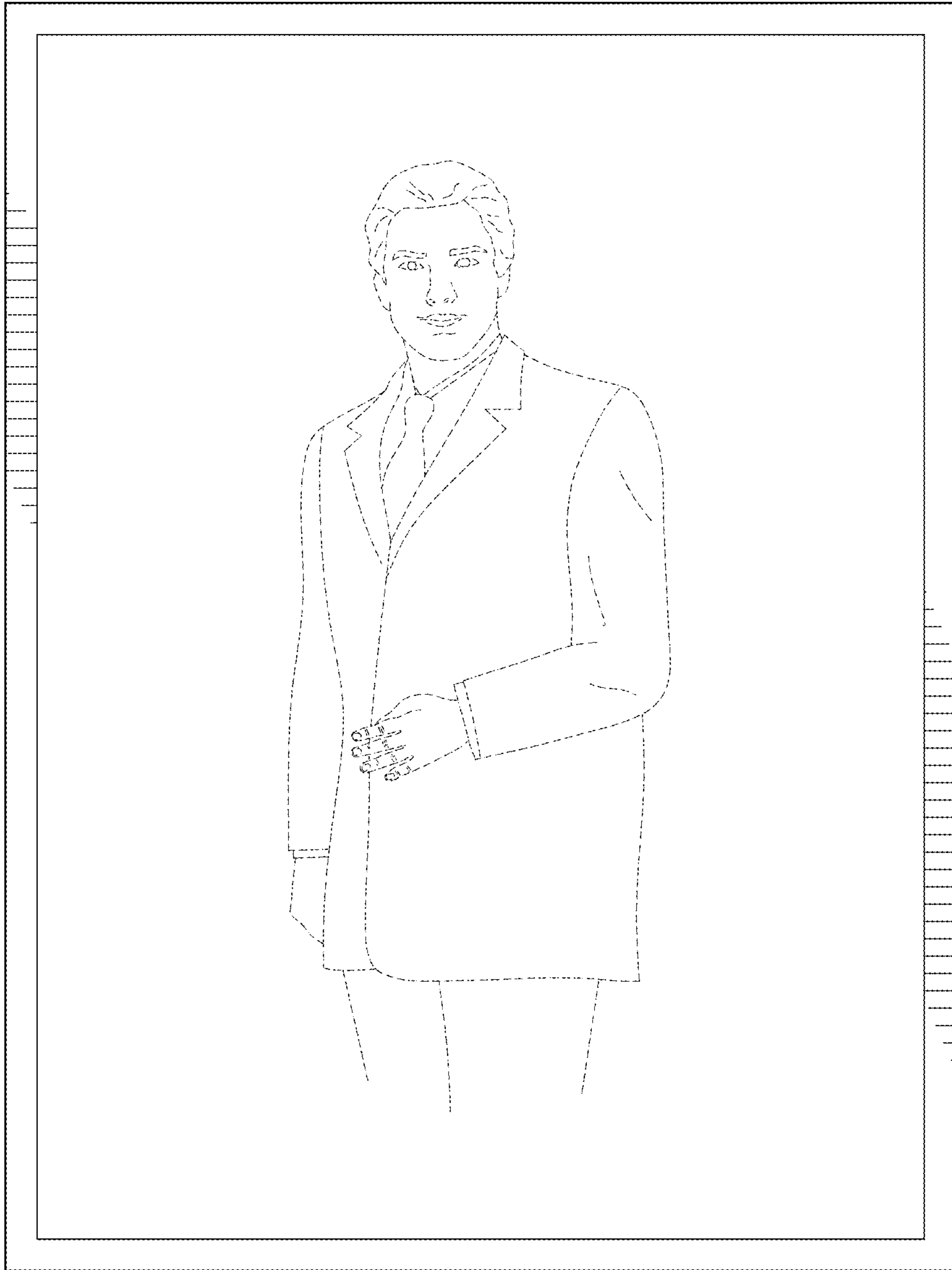

FIG. 3

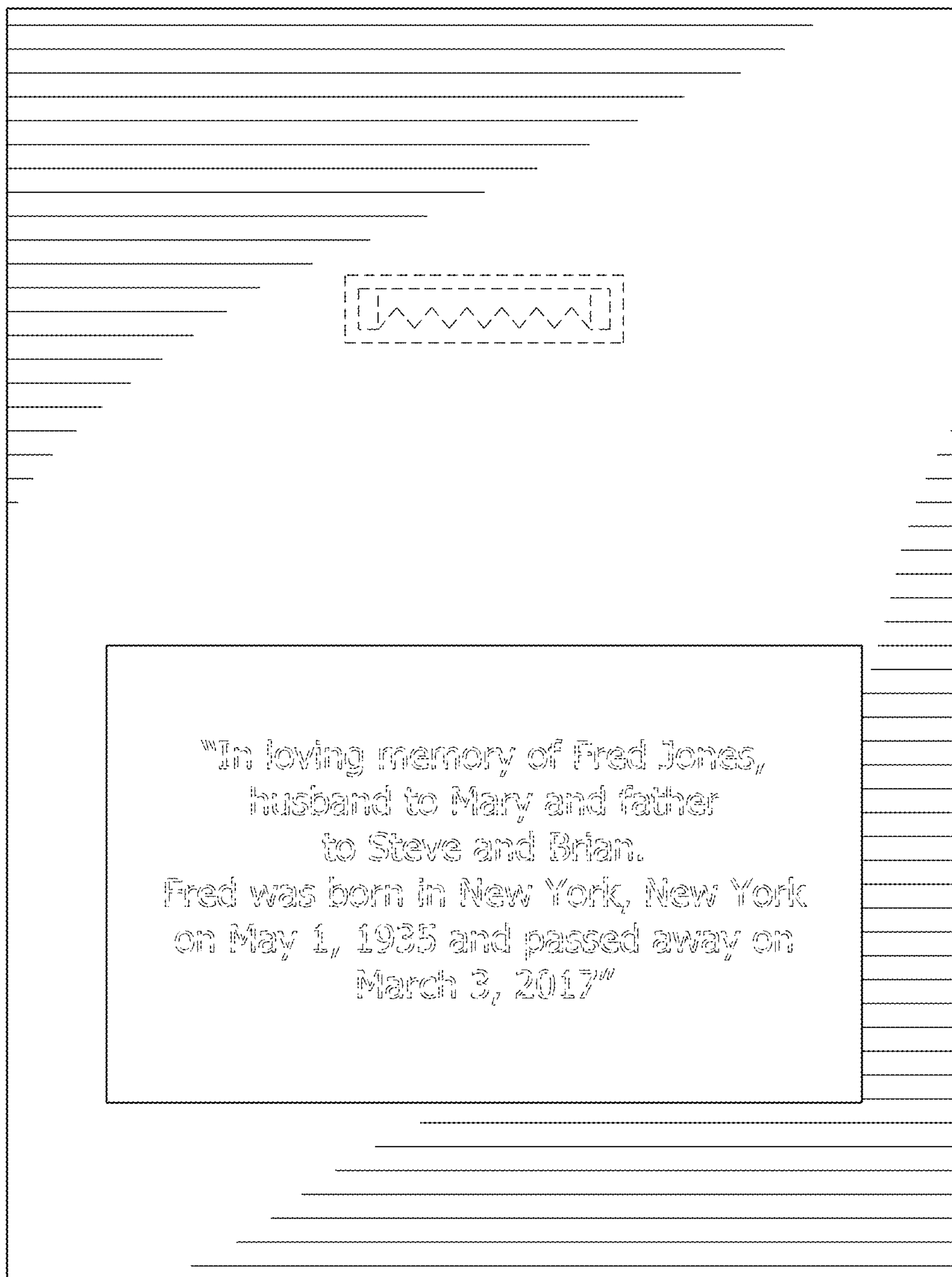

FIG. 4

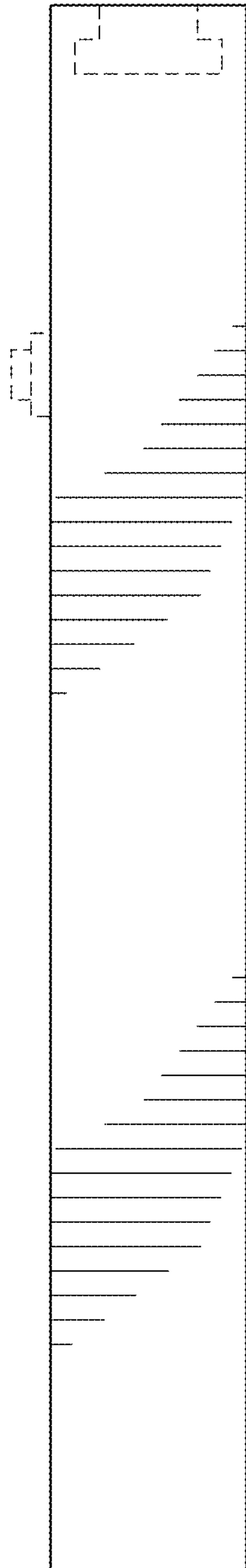

FIG. 5

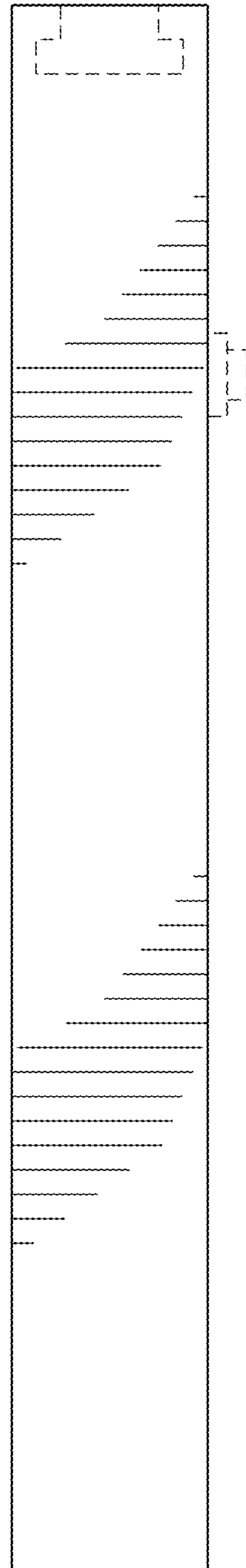

FIG. 6

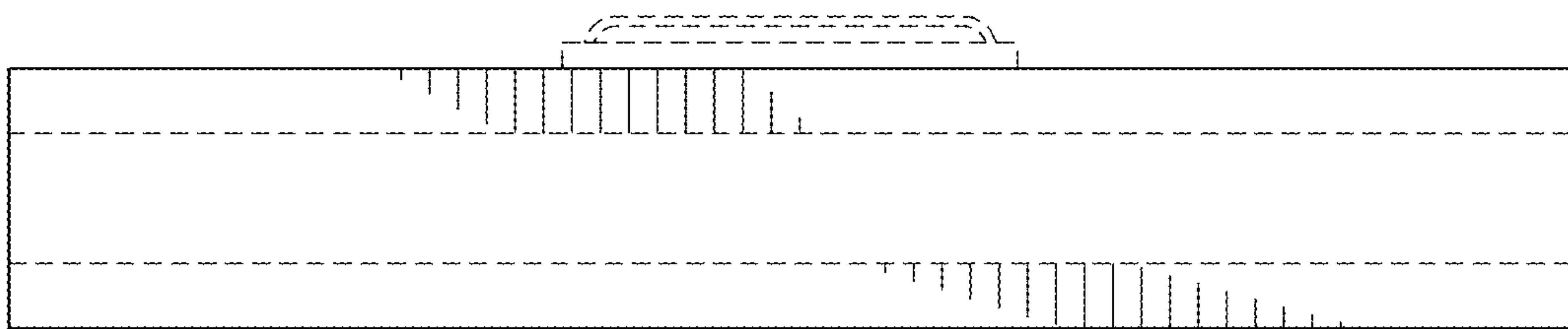

FIG. 7

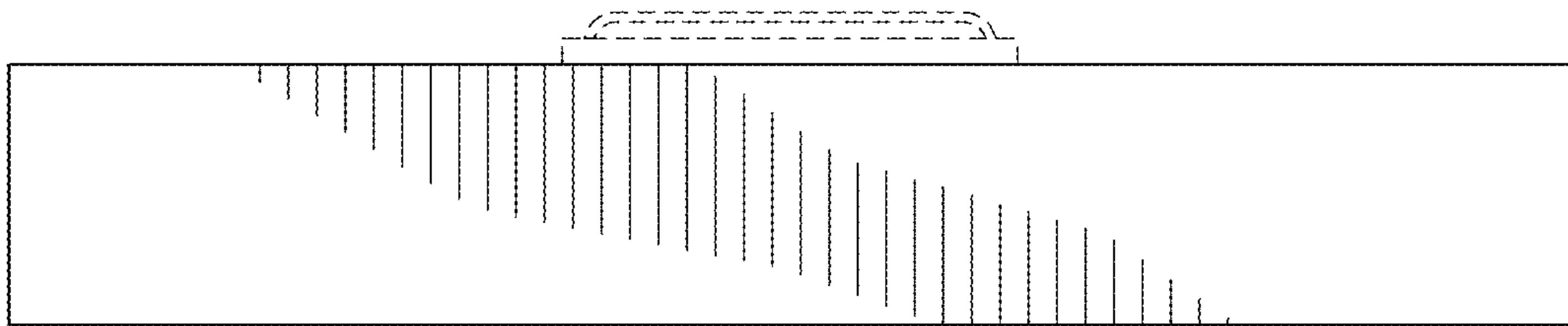

FIG. 8



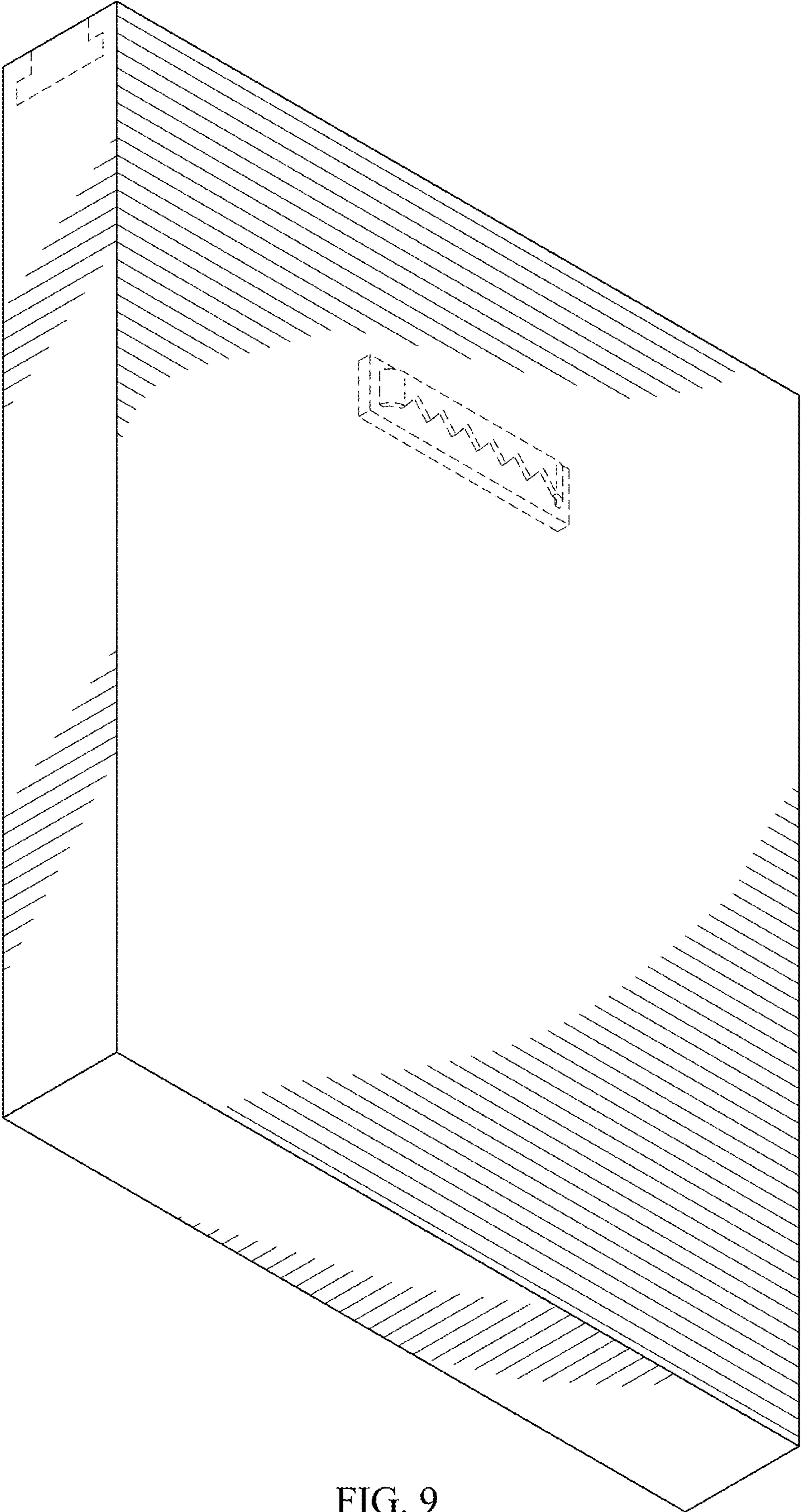

FIG. 9

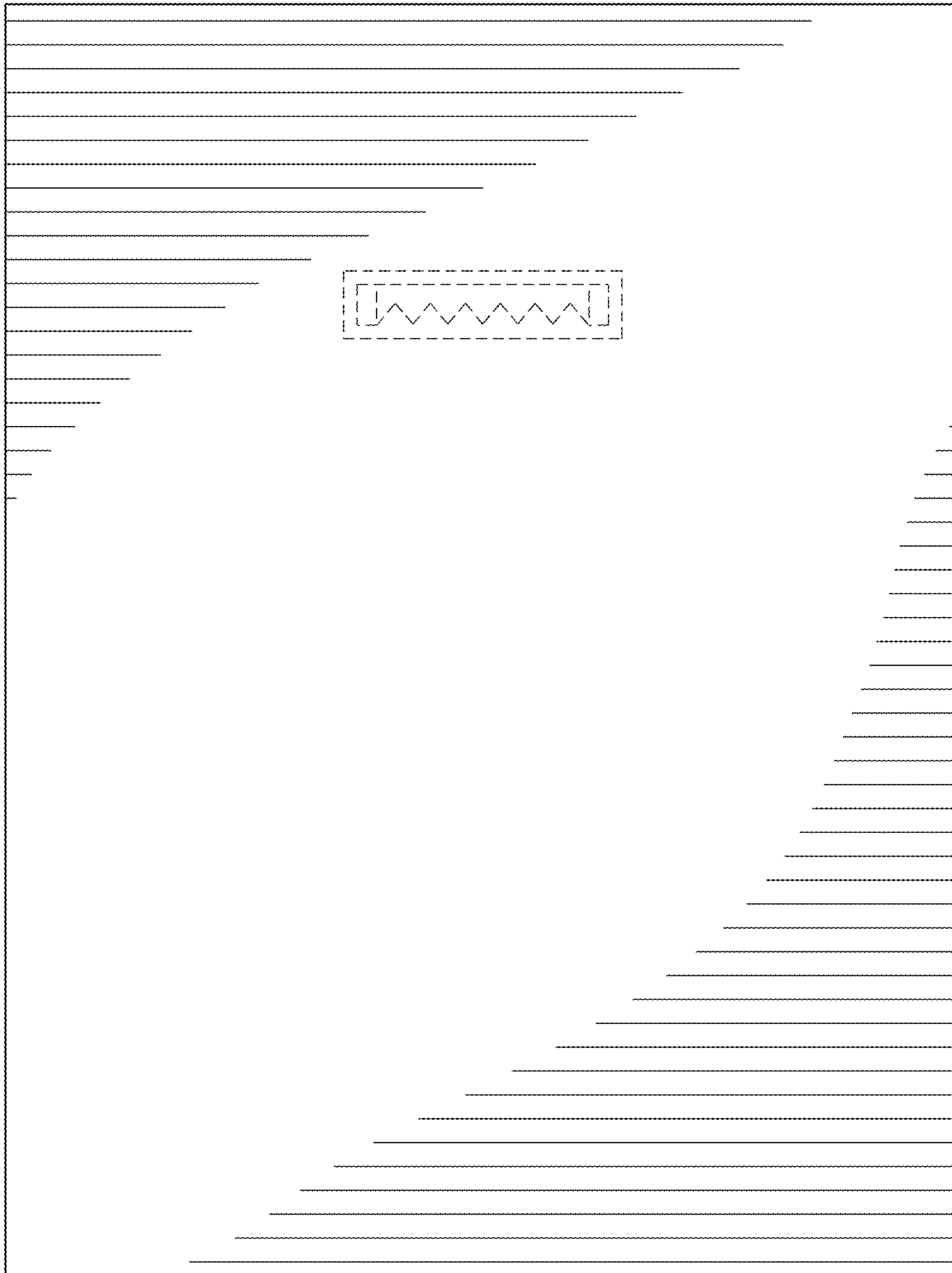

FIG. 10

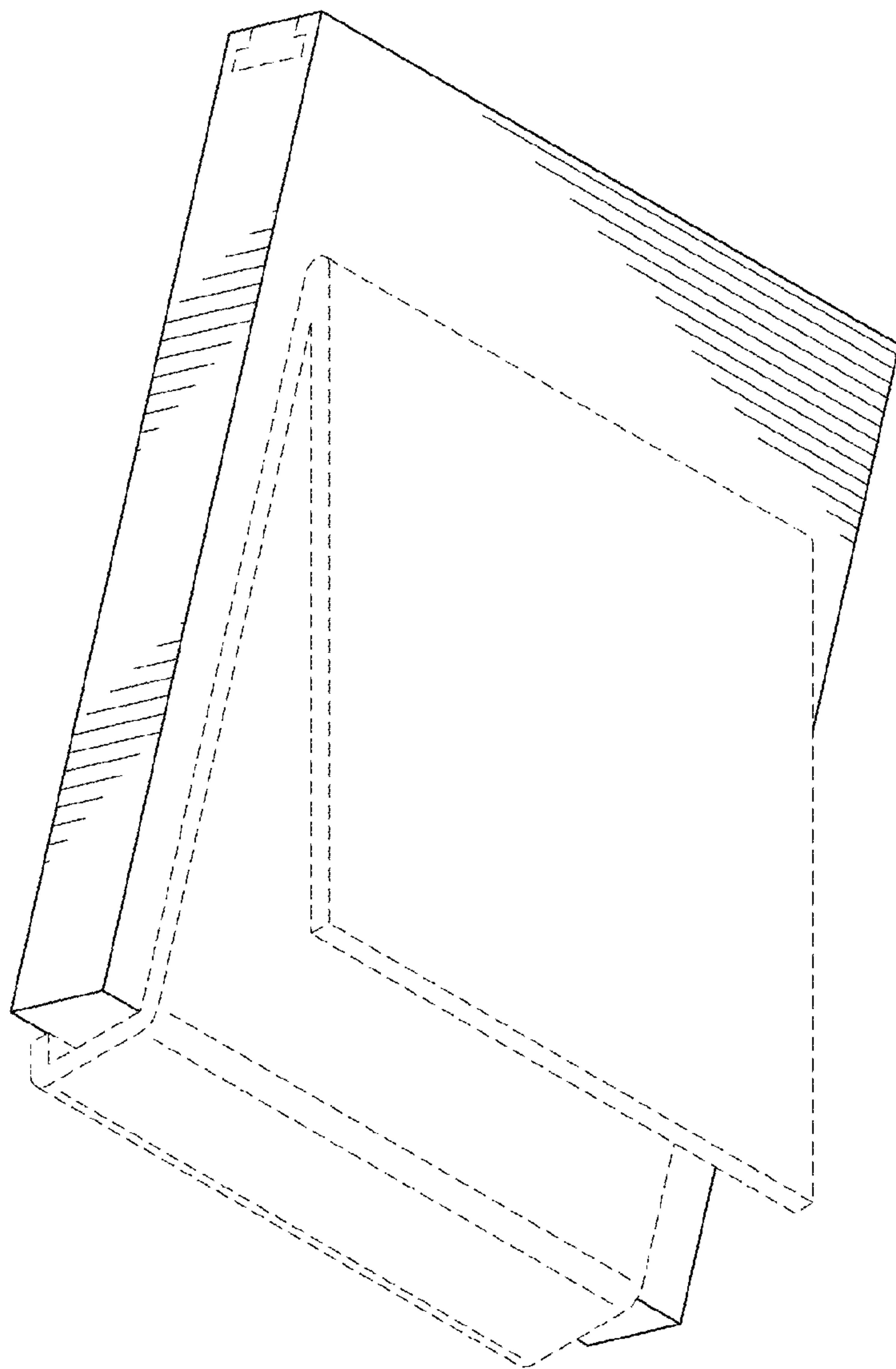

FIG. 11

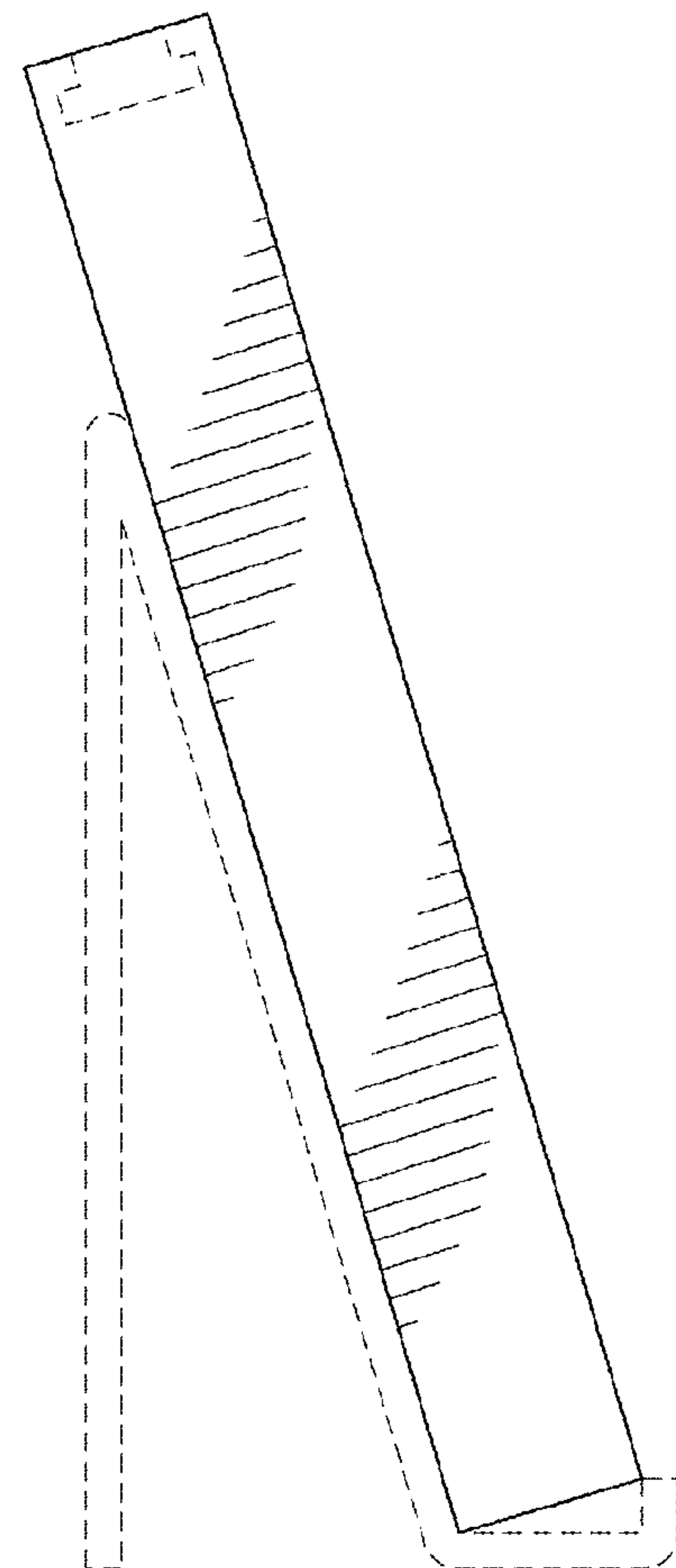

FIG. 12

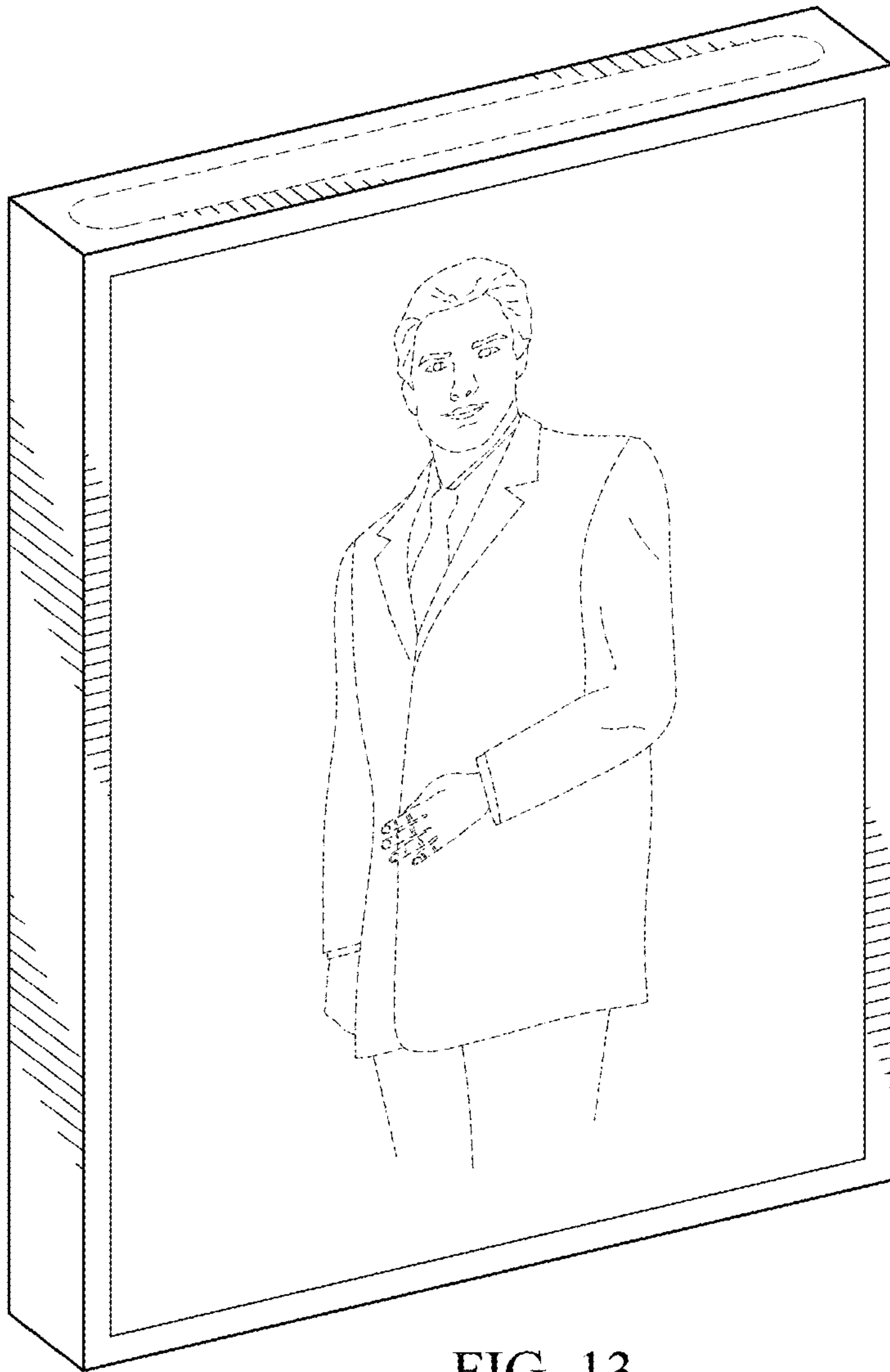

FIG. 13

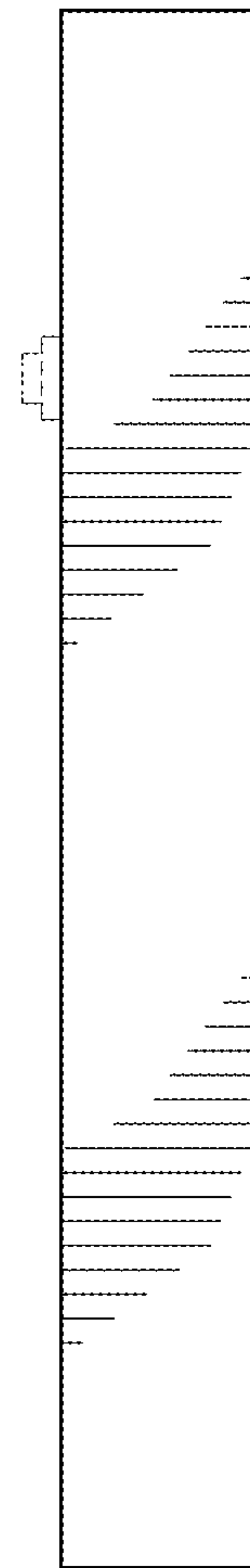

FIG. 14



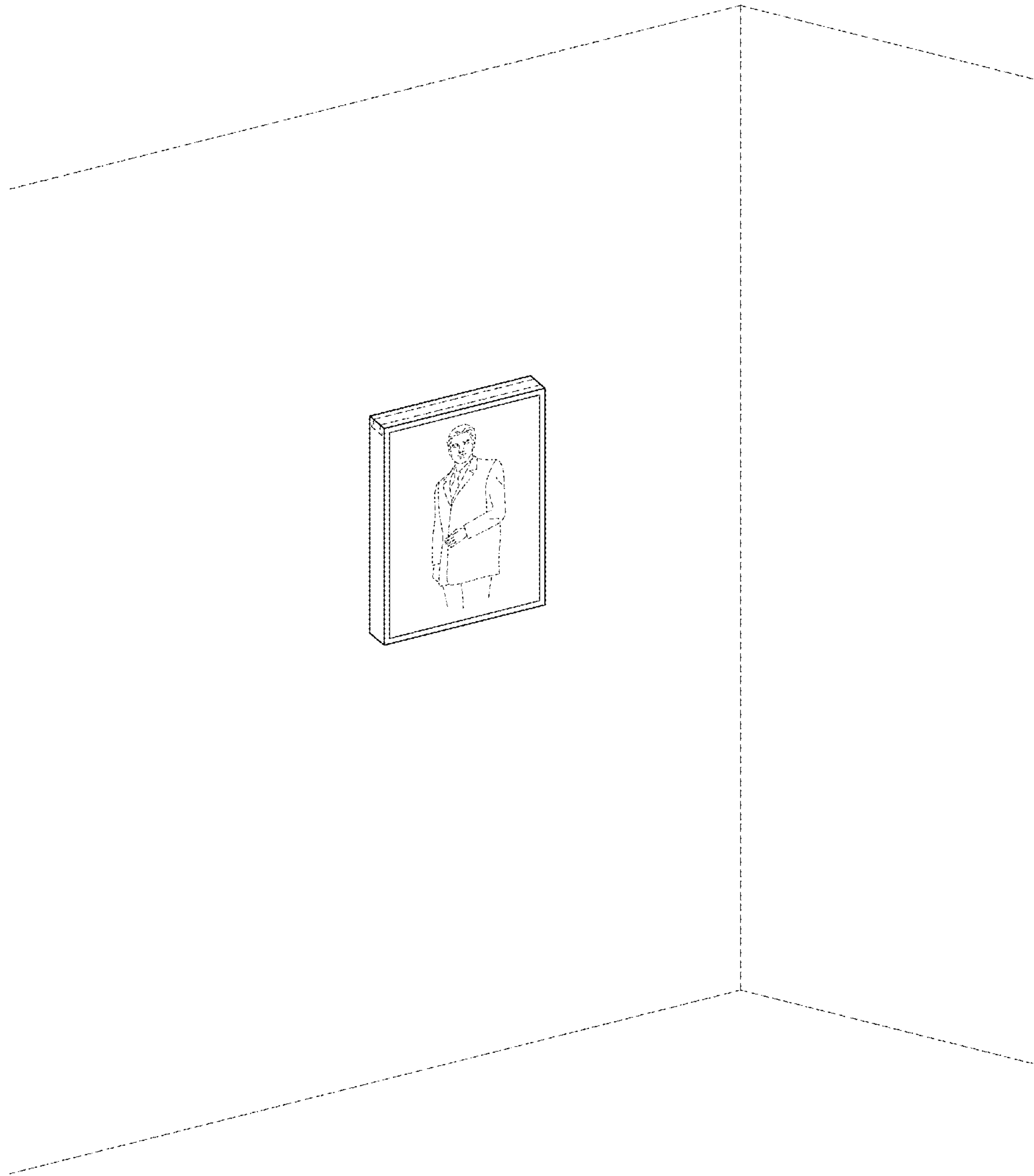

FIG. 15

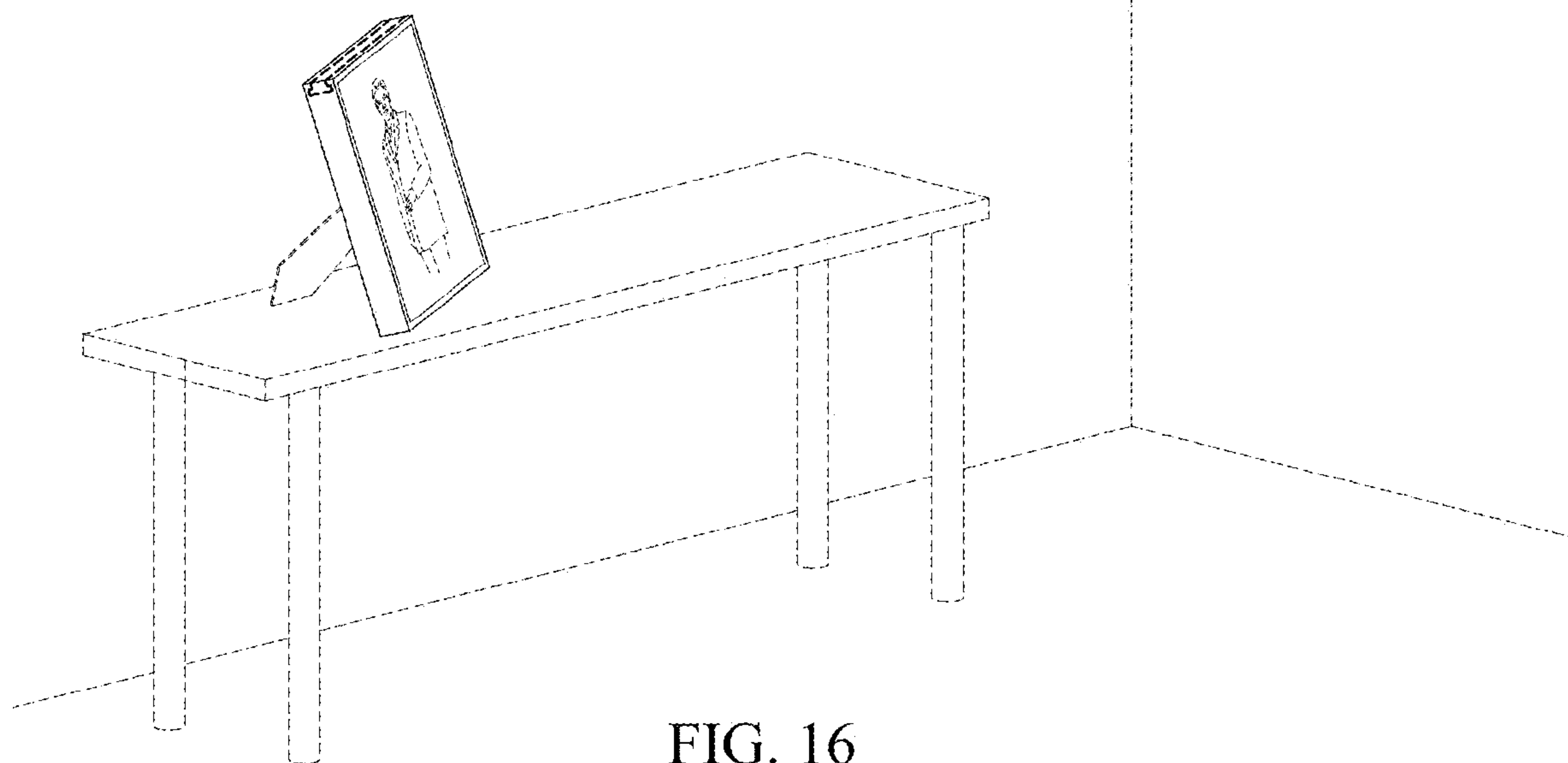

FIG. 16

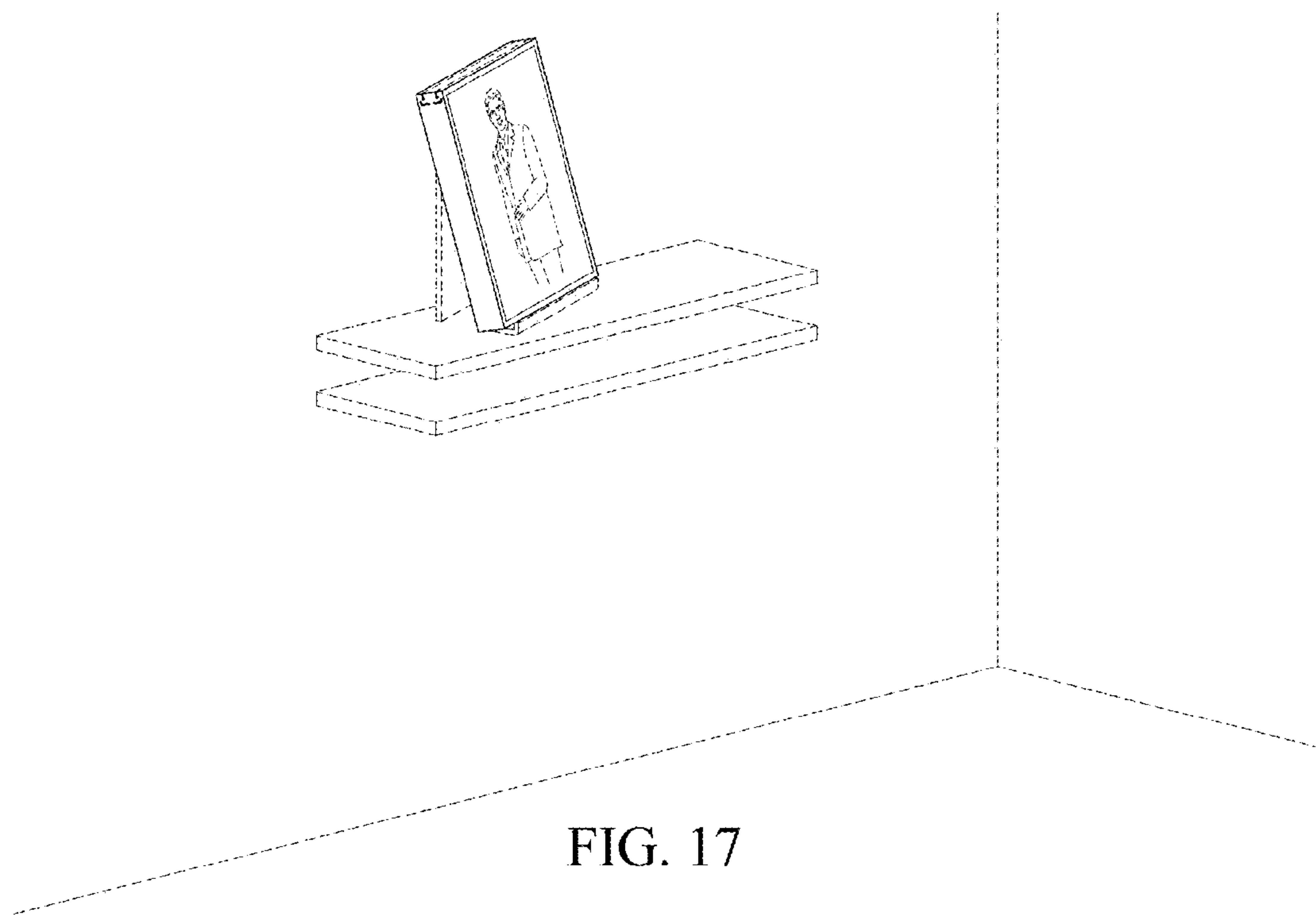

FIG. 17

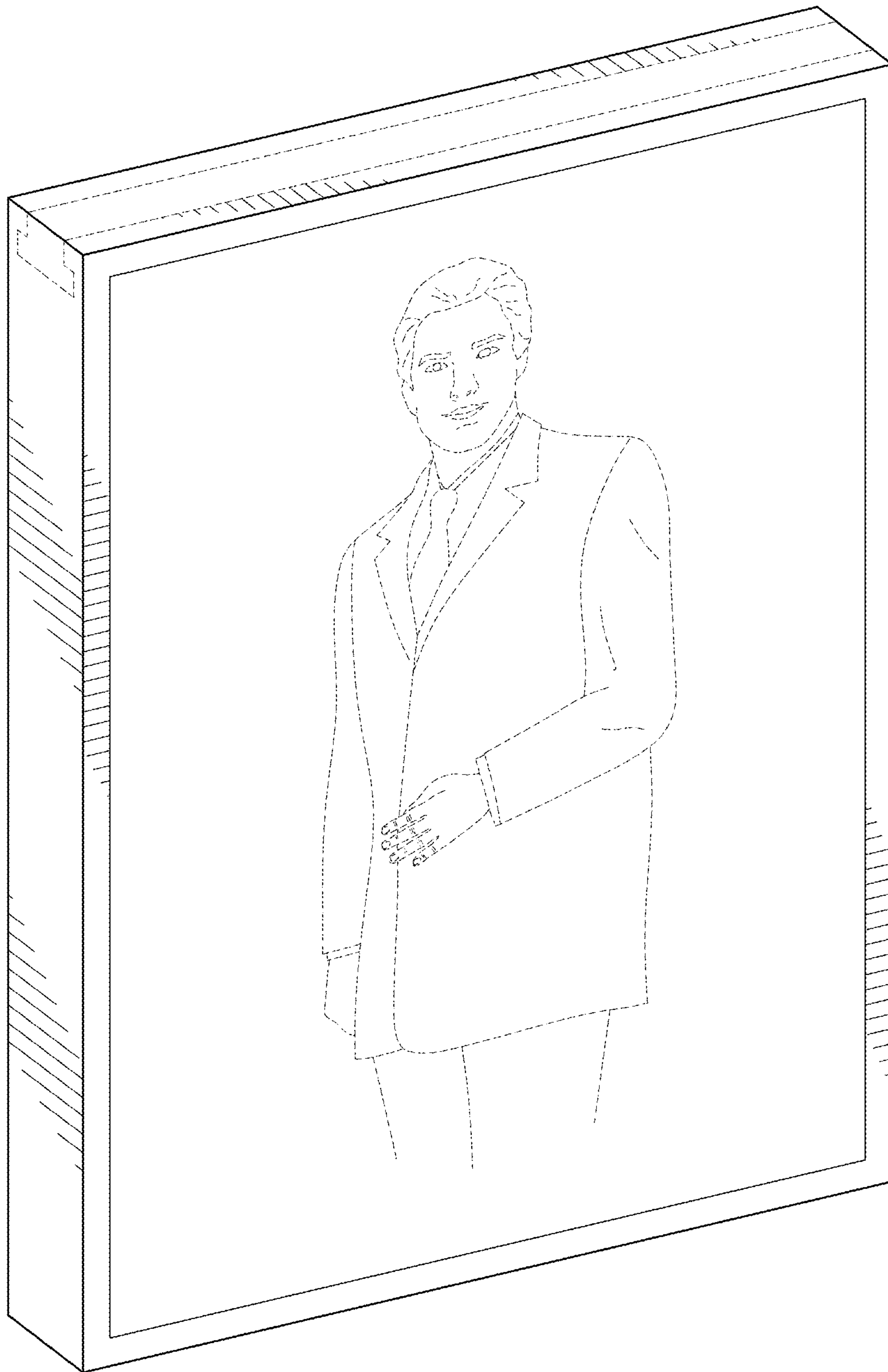

FIG. 18

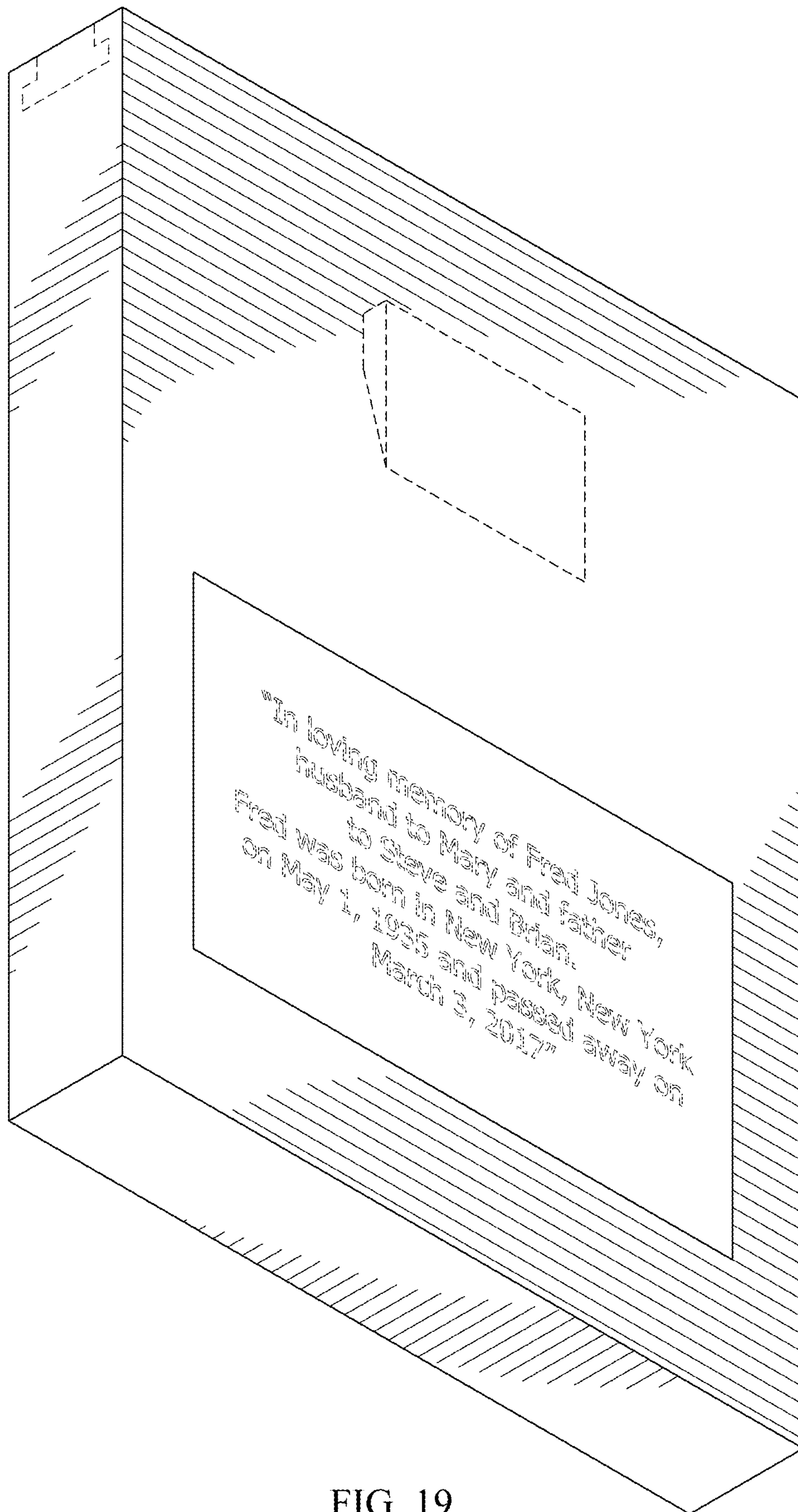

FIG. 19



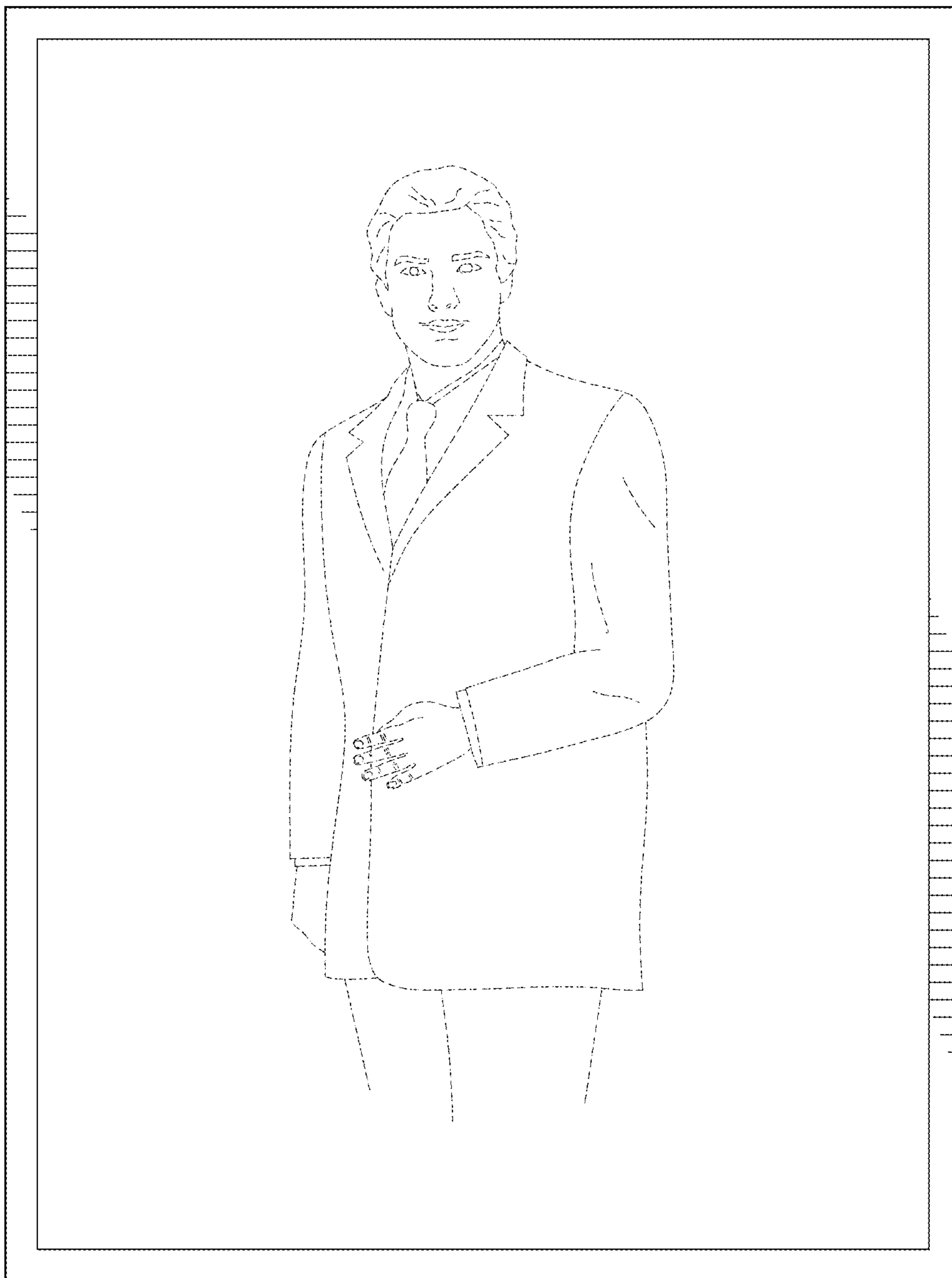

FIG. 20

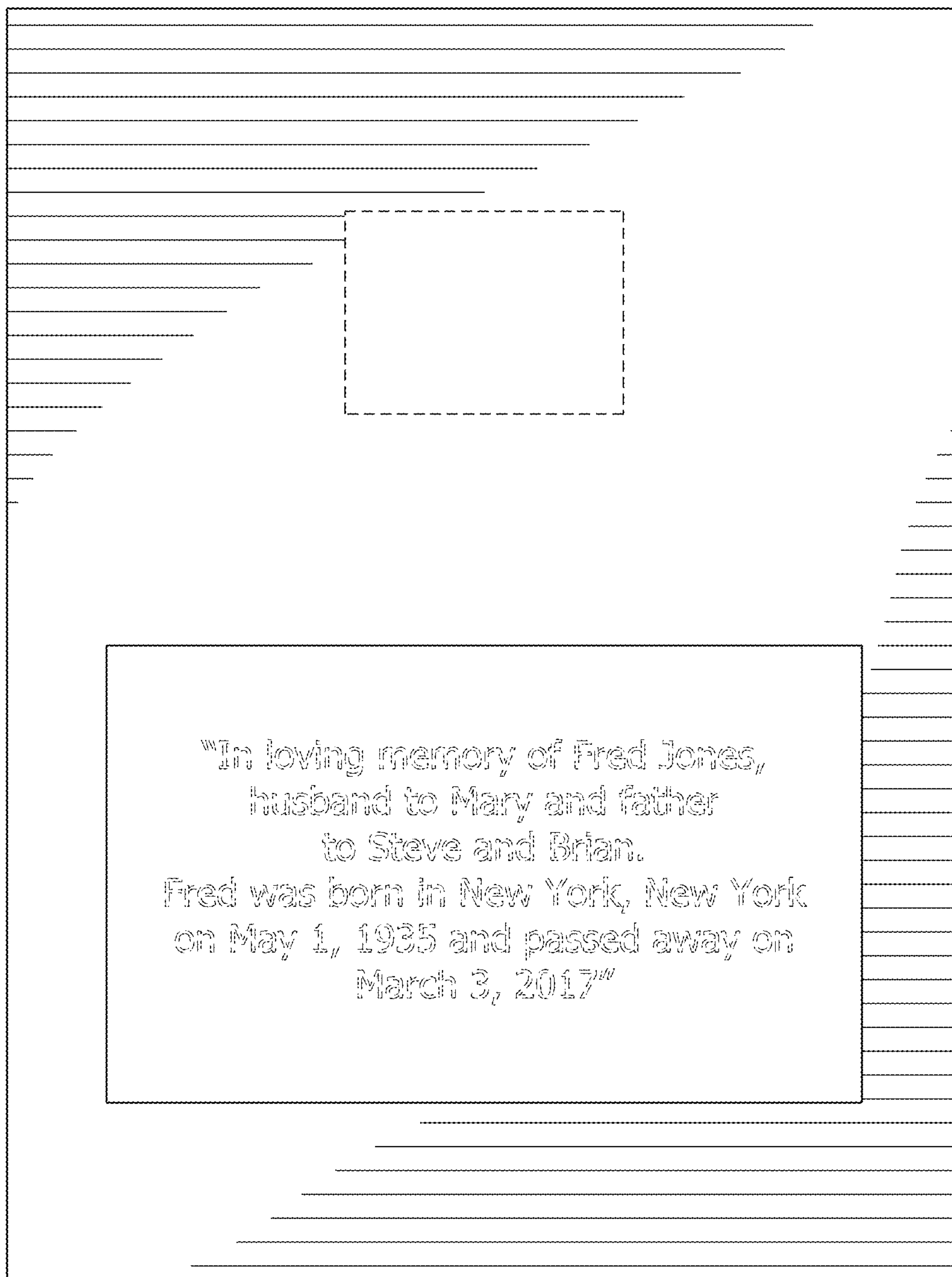

FIG. 21

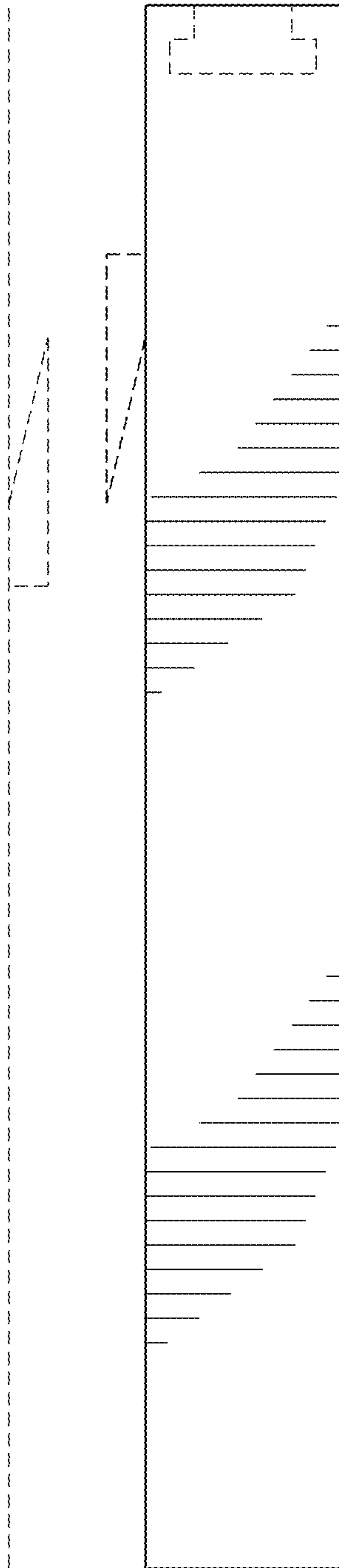

FIG. 22

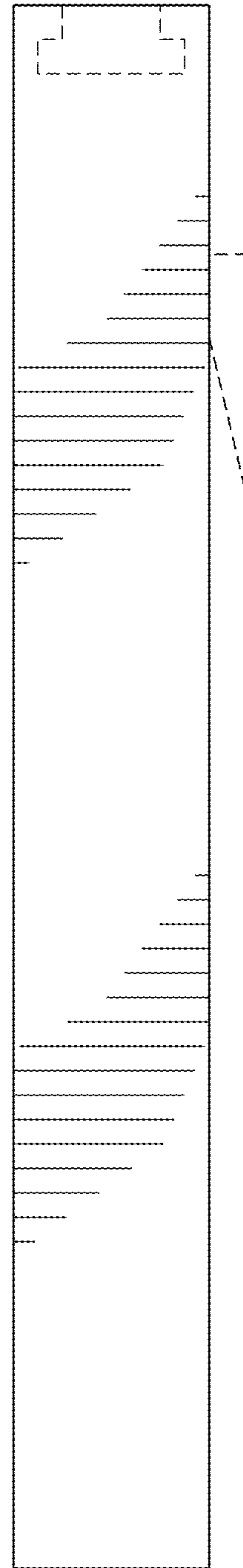

FIG. 23

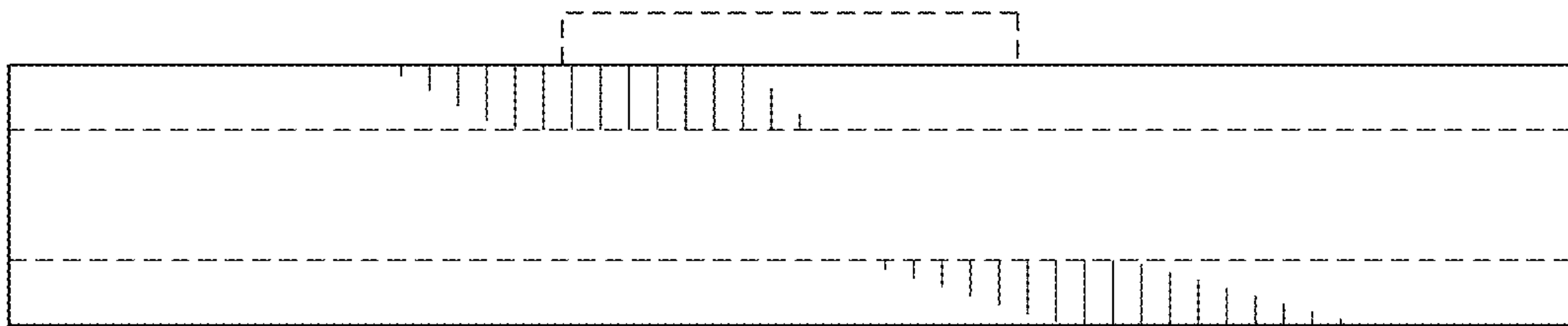

FIG. 24

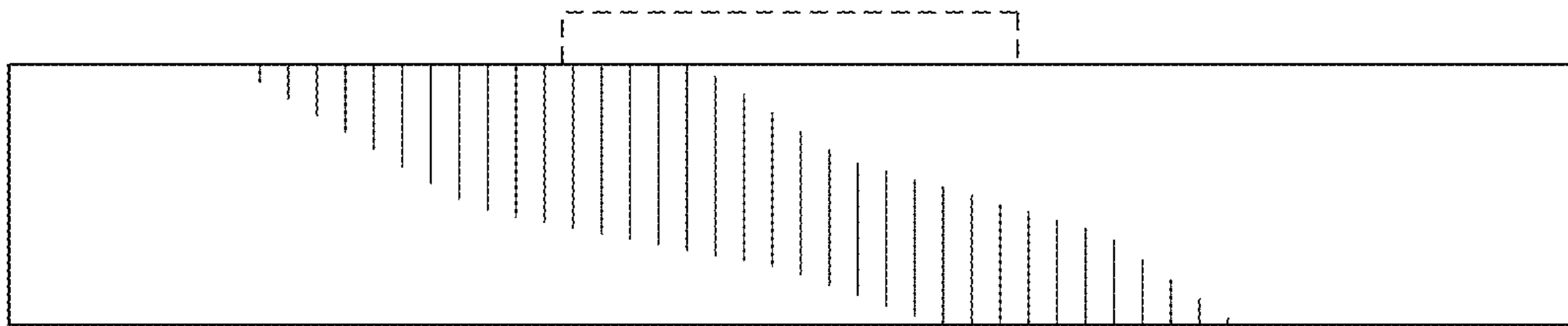

FIG. 25