



US00D947466S

(12) **United States Design Patent**
Chang et al.

(10) **Patent No.:** **US D947,466 S**
(45) **Date of Patent:** **** Mar. 29, 2022**

(54) **REVERSIBLE PET HARNESS**

(57) **CLAIM**

(71) Applicant: **Sassy Woof LLC**, Sterling, VA (US)

The ornamental design for a reversible pet harness, as shown and described.

(72) Inventors: **Christine N. Chang**, Sterling, VA (US);
Arturo Chang, Sterling, VA (US)

(73) Assignee: **Sassy Woof LLC**, Sterling, VA (US)

(**) Term: **15 Years**

(21) Appl. No.: **29/769,859**

(22) Filed: **Feb. 8, 2021**

(51) **LOC (13) Cl.** **30-04**

(52) **U.S. Cl.**
USPC **D30/152**; D8/306; D11/218

(58) **Field of Classification Search**
USPC D30/144, 145, 151, 152, 199;
D29/101.1, 101.3, 101.4; D24/190;
(Continued)

(56) **References Cited**

U.S. PATENT DOCUMENTS

2,464,867 A 3/1949 Johnson
3,768,445 A 10/1973 Sorrels
(Continued)

FOREIGN PATENT DOCUMENTS

EP 3257370 12/2017
JP 2018153104 10/2018

OTHER PUBLICATIONS

“Barkbay: No-Pull Dog Harness”. Found online Sep. 7, 2021 at amazon.com. Reference dated Jun. 3, 2019. Retrieved from https://www.amazon.com/dp/B07SHS65PR/ref=sspa_dk_detail_0?*

(Continued)

Primary Examiner — Kendra Leslie Hamilton
(74) *Attorney, Agent, or Firm* — Morgan, Lewis & Bockius LLP

DESCRIPTION

FIG. 1 is a front perspective view of a reversible pet harness showing our new design in a condition of use in a first configuration and with a ring extending from a first side of the reversible pet harness;

FIG. 2 is a front perspective view thereof;

FIG. 3 is a rear perspective view thereof;

FIG. 4 is a front elevational view thereof;

FIG. 5 is a rear elevational view thereof;

FIG. 6 is a right-side elevational view thereof;

FIG. 7 is a left-side elevational view thereof;

FIG. 8 is a top plan view thereof;

FIG. 9 is a bottom plan view thereof;

FIG. 10 is an enlarged front perspective view thereof;

FIG. 11 is an enlarged rear perspective view thereof;

FIG. 12 is a front perspective view of the reversible pet harness of FIG. 1 shown in a condition of use in a second configuration inverted from the first configuration with the ring moved to extend from a second side of the reversible pet harness;

FIG. 13 is a front perspective view thereof;

FIG. 14 is a rear perspective view thereof;

FIG. 15 is a front elevational view thereof;

FIG. 16 is a rear elevational view thereof;

FIG. 17 is a right-side elevational view thereof;

FIG. 18 is a left-side elevational view thereof;

FIG. 19 is a top plan view thereof;

FIG. 20 is a bottom plan view thereof;

FIG. 21 is an enlarged front perspective view thereof; and,

FIG. 22 is an enlarged rear perspective view thereof.

The longer equally spaced broken lines on the reversible pet harness depict portions of the reversible pet harness that form no part of the claimed design. The shorter equally spaced broken lines on the reversible pet harness depict stitching that forms no part of the claimed design. In FIGS. 1 and 12, the longer equally spaced broken lines showing a

(Continued)

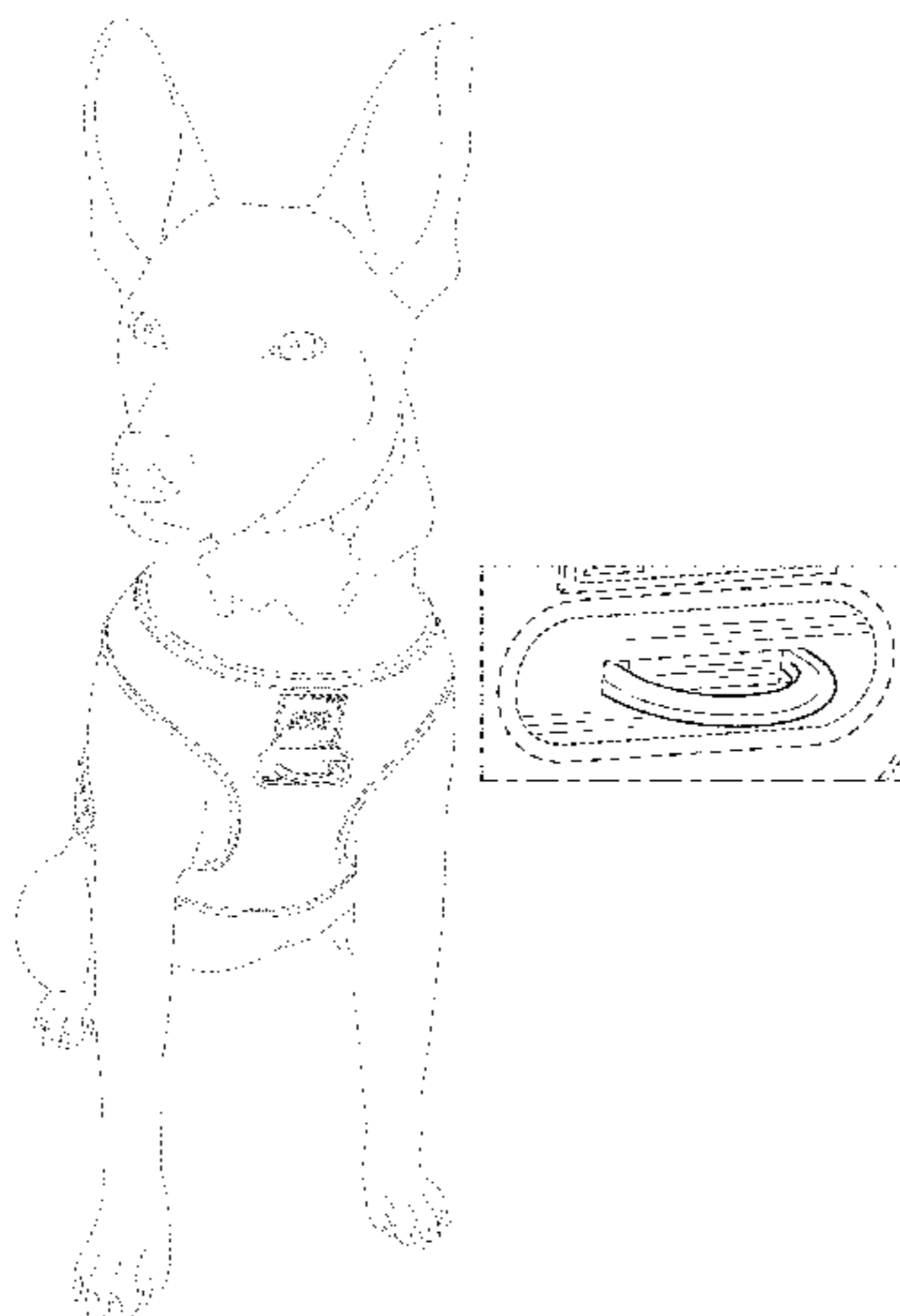

dog depict environmental structure only and form no part of the claimed design. All of the broken lines form no part of the claimed design.

1 Claim, 18 Drawing Sheets

(58) **Field of Classification Search**

USPC D11/200, 212, 214, 215, 216, 218;
D8/306, 315
CPC A01K 27/002; A44B 13/00
See application file for complete search history.

(56) **References Cited**

U.S. PATENT DOCUMENTS

5,357,735 A * 10/1994 Fry B68B 1/06
54/9
5,941,199 A 8/1999 Tamura
D424,761 S 5/2000 Mortenson
D454,691 S * 3/2002 Proot D3/318
6,792,894 B1 9/2004 Donaldson
D548,560 S * 8/2007 Weinerman D8/306
D609,408 S 2/2010 Labelson et al.
D625,574 S * 10/2010 Burns D8/306
D633,257 S 2/2011 Trias
7,891,322 B2 2/2011 Bennett et al.
8,210,131 B2 7/2012 Friedland
D681,287 S 4/2013 Collingnon
8,627,788 B2 1/2014 Seboe
D739,303 S 9/2015 Kinskey
D754,936 S * 4/2016 Levy D30/199
9,420,763 B2 4/2016 Batista
D769,705 S * 10/2016 Moreau D11/201
9,578,857 B2 2/2017 Goluboff
9,655,344 B1 5/2017 Sebo
D790,780 S * 6/2017 Strengell D30/152

D791,991 S 7/2017 Brauser et al.
9,936,678 B2 4/2018 Sebo
10,334,821 B2 7/2019 Yun
D862,002 S 10/2019 Wu
D883,581 S 5/2020 Daly et al.
D886,395 S 6/2020 Han et al.
D891,295 S * 7/2020 Andersson D11/218
D893,811 S 8/2020 Wu
D905,353 S 12/2020 Giesen et al.
D911,631 S * 2/2021 Stouder D30/152
D914,302 S * 3/2021 Chen D30/152
11,102,958 B1 * 8/2021 Chang A01K 27/002
2008/0134991 A1 6/2008 Depass
2008/0223310 A1 9/2008 Remick et al.
2014/0182520 A1 7/2014 Goluboff
2017/0216635 A1 * 8/2017 Stibilj A62B 35/0025
2019/0373860 A1 12/2019 Kath
2020/0245592 A1 8/2020 Wagner
2021/0153476 A1 * 5/2021 Richards A01K 27/002

OTHER PUBLICATIONS

“Dean & Tyler: Universal No Pull Dog Harness with Service Dog Velcro Patches”. Found online Feb. 14, 2018 at amazon.com. Reference dated Nov. 23, 2012. Retrieved from https://www.amazon.com/Universal-Harness-Service-Black-Large/dp/B004PB8V6A/ref=cm_cr_arp_d_product_top?ie=UTF8.*

“Yonie’s Harness Shop: Floppy Territ for Neckstraps”. Found online Sep. 7, 2021 at yonies.com. Reference dated Aug. 5, 2016. Retrieved from https://web.archive.org/web/20160805113037/http://www.yonies.com/catalog/product_info.php/floppy-territ-stainless-steel-for-neckstraps-p-534.*

“Skylotec: Stainless Steel Anchor Bolt for a Safety Harness”. Found online Sep. 7, 2021 at pnghut.com. Reference dated Jul. 28, 2018. Retrieved from <https://pnghut.com/png/JNwGtZdXKE/stainless-steel-anchor-bolt-safety-harness-hardware-accessory-gps-tractor-transparent-png>.*

* cited by examiner

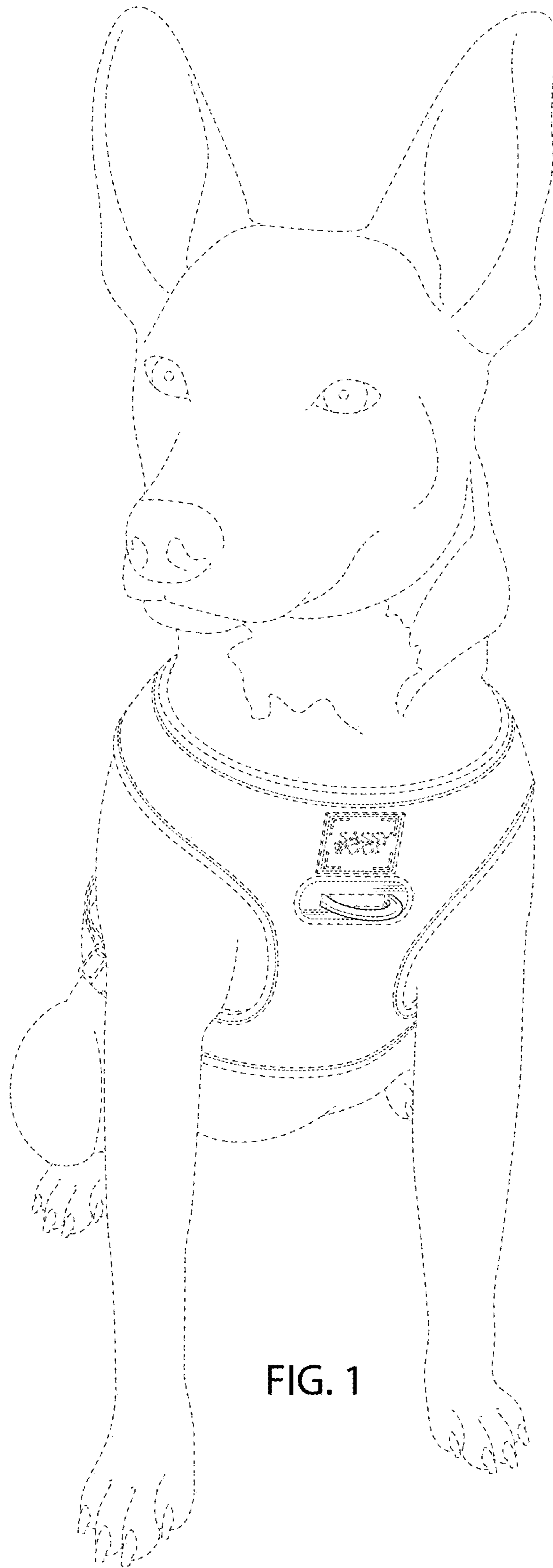

FIG. 1

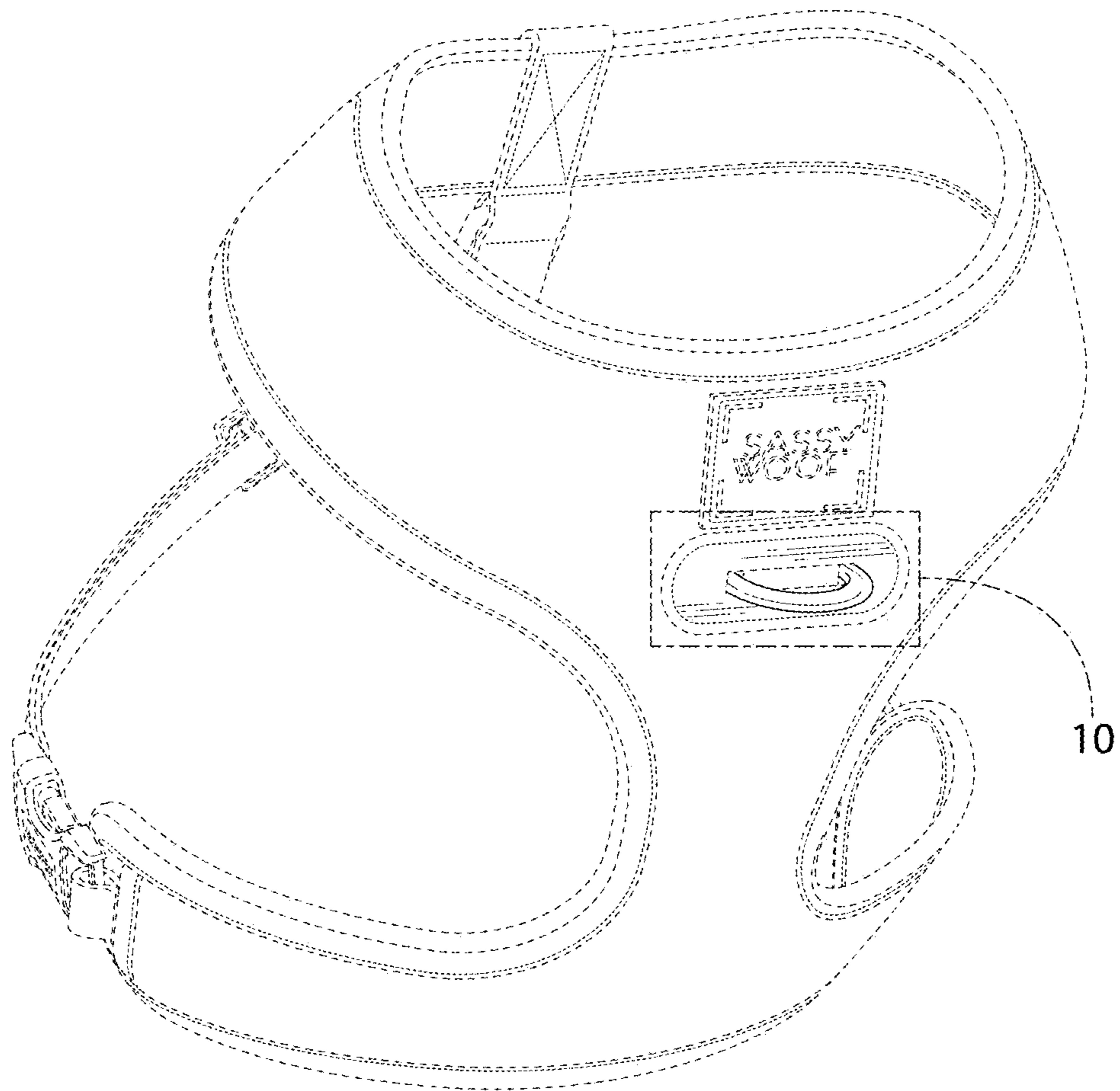

FIG. 2

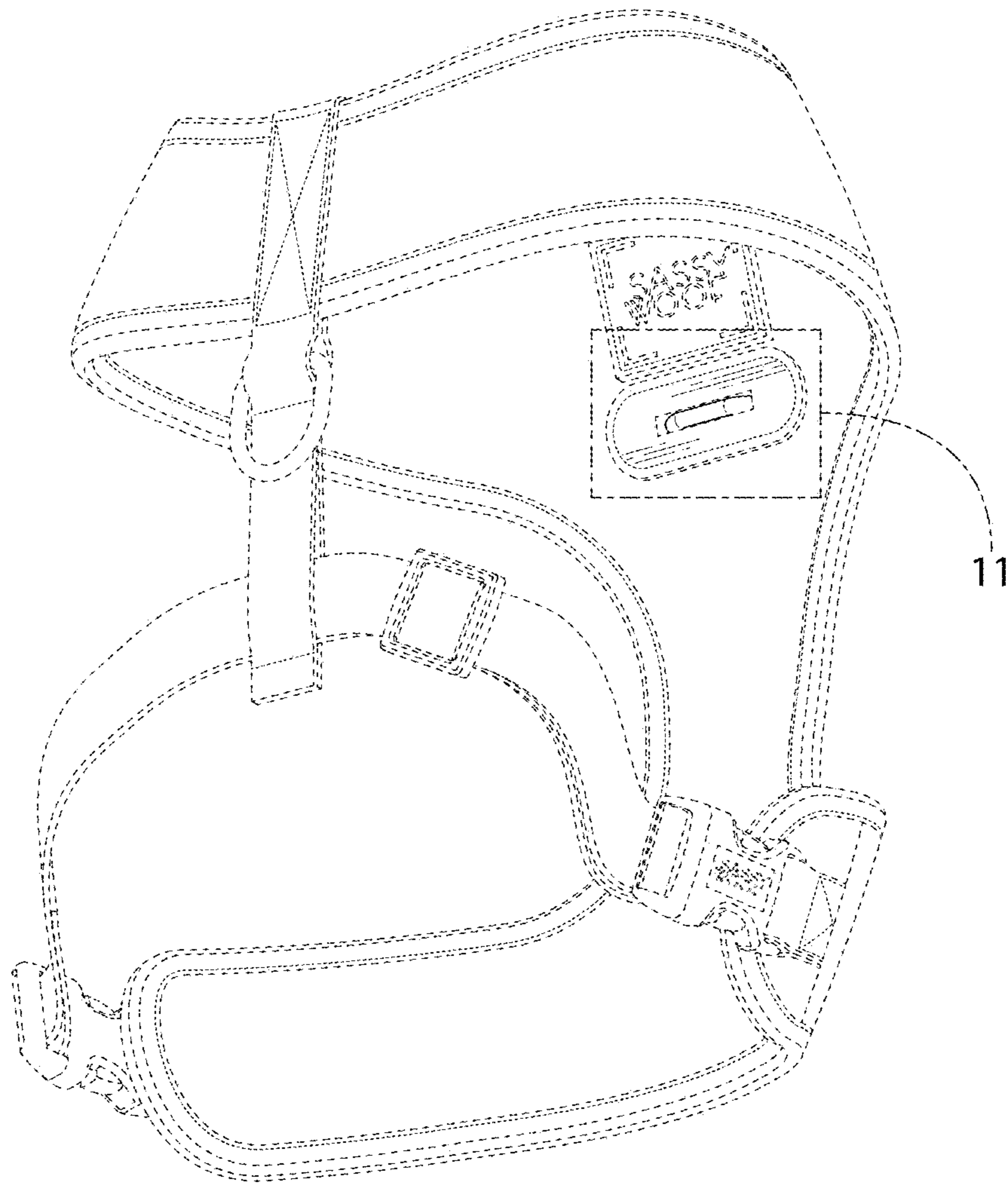

FIG. 3

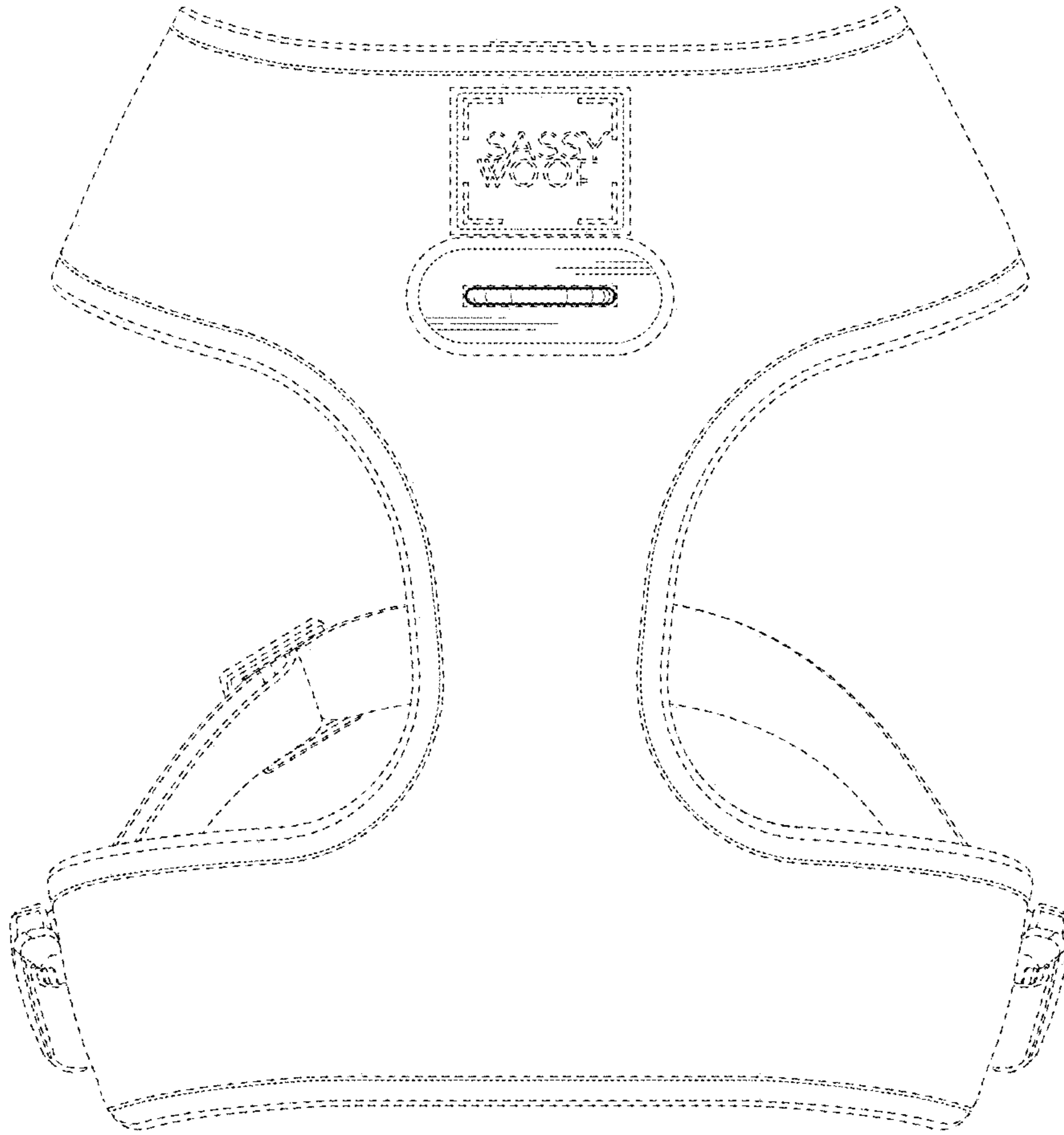

FIG. 4

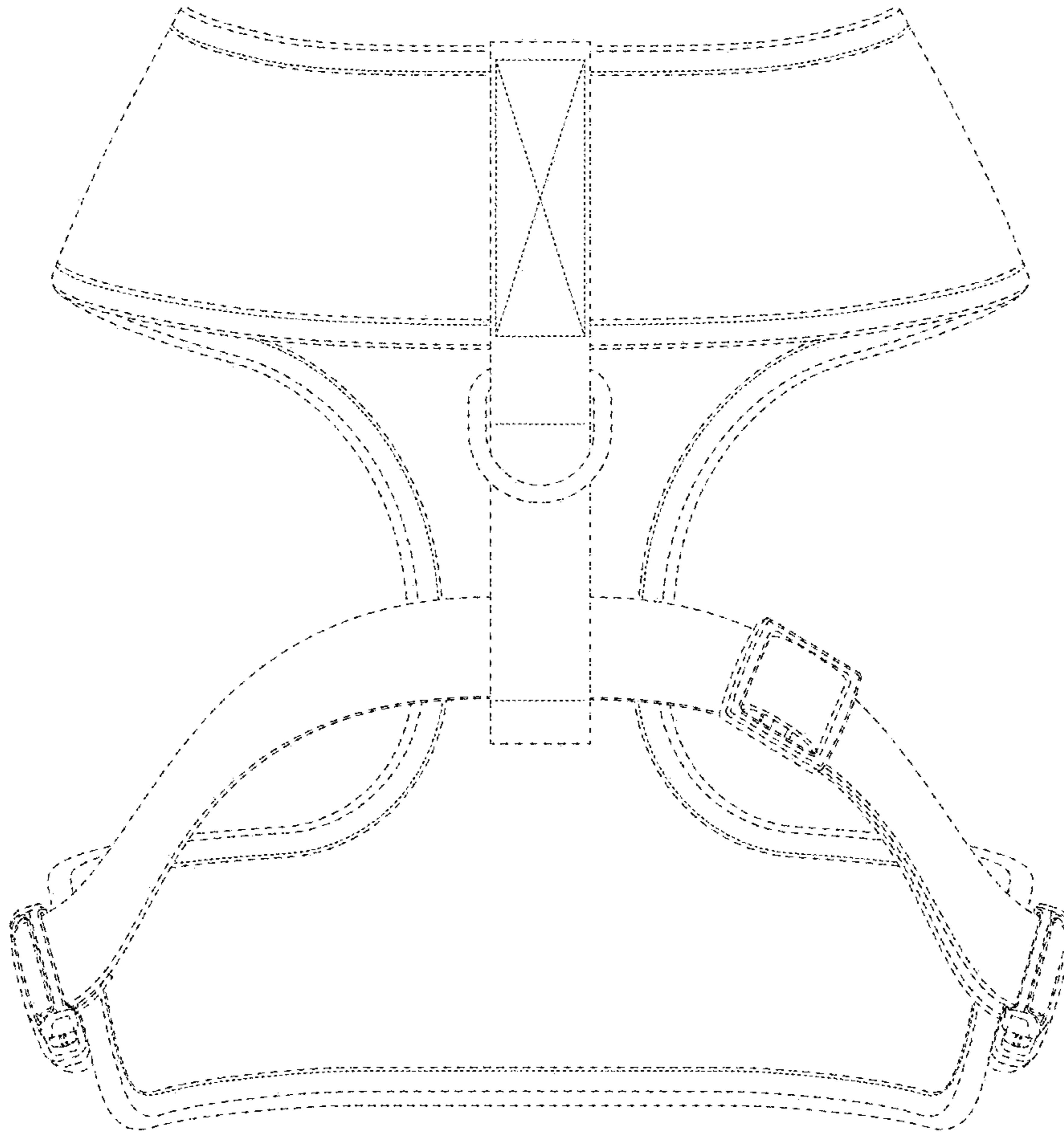

FIG. 5

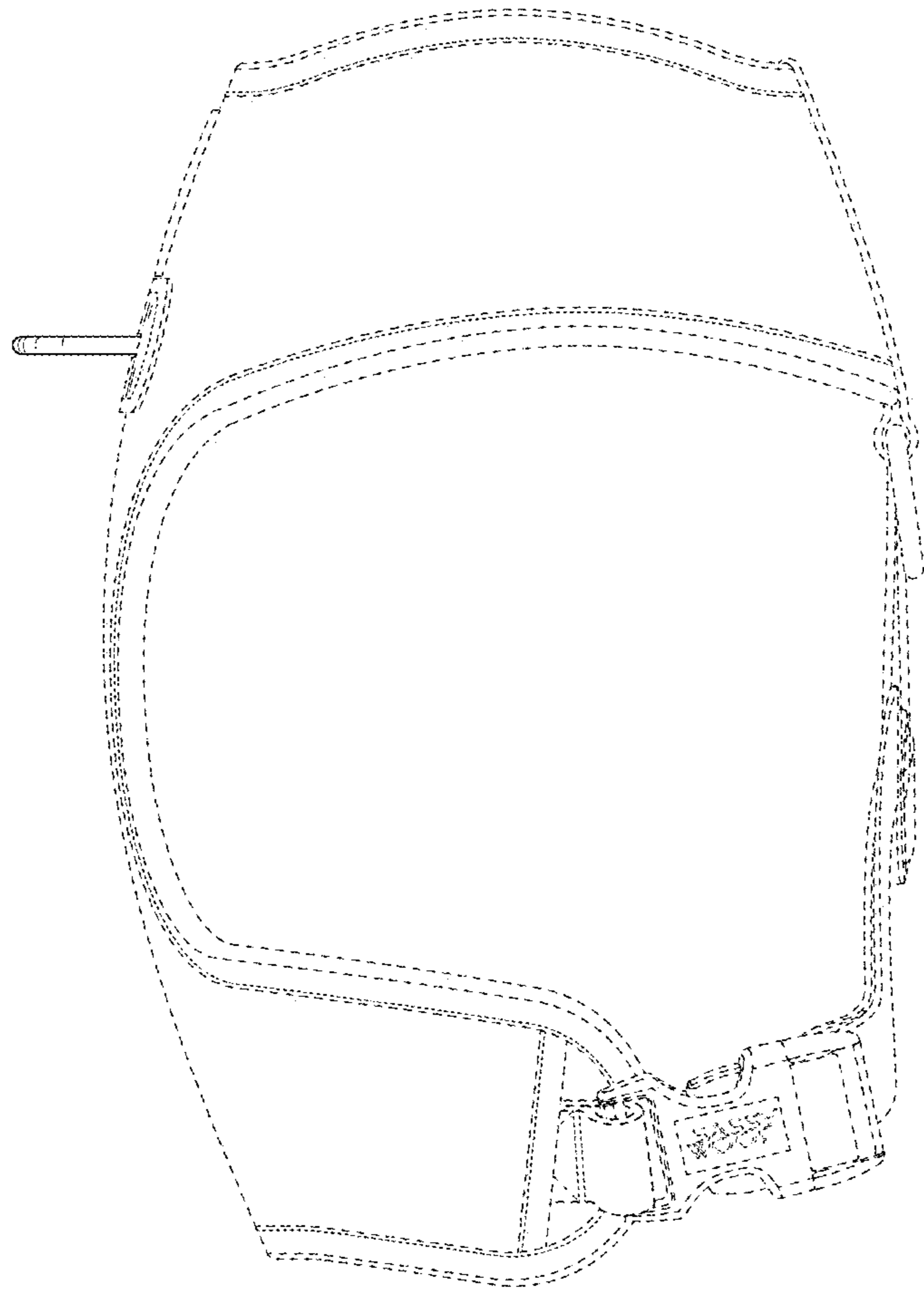

FIG. 6

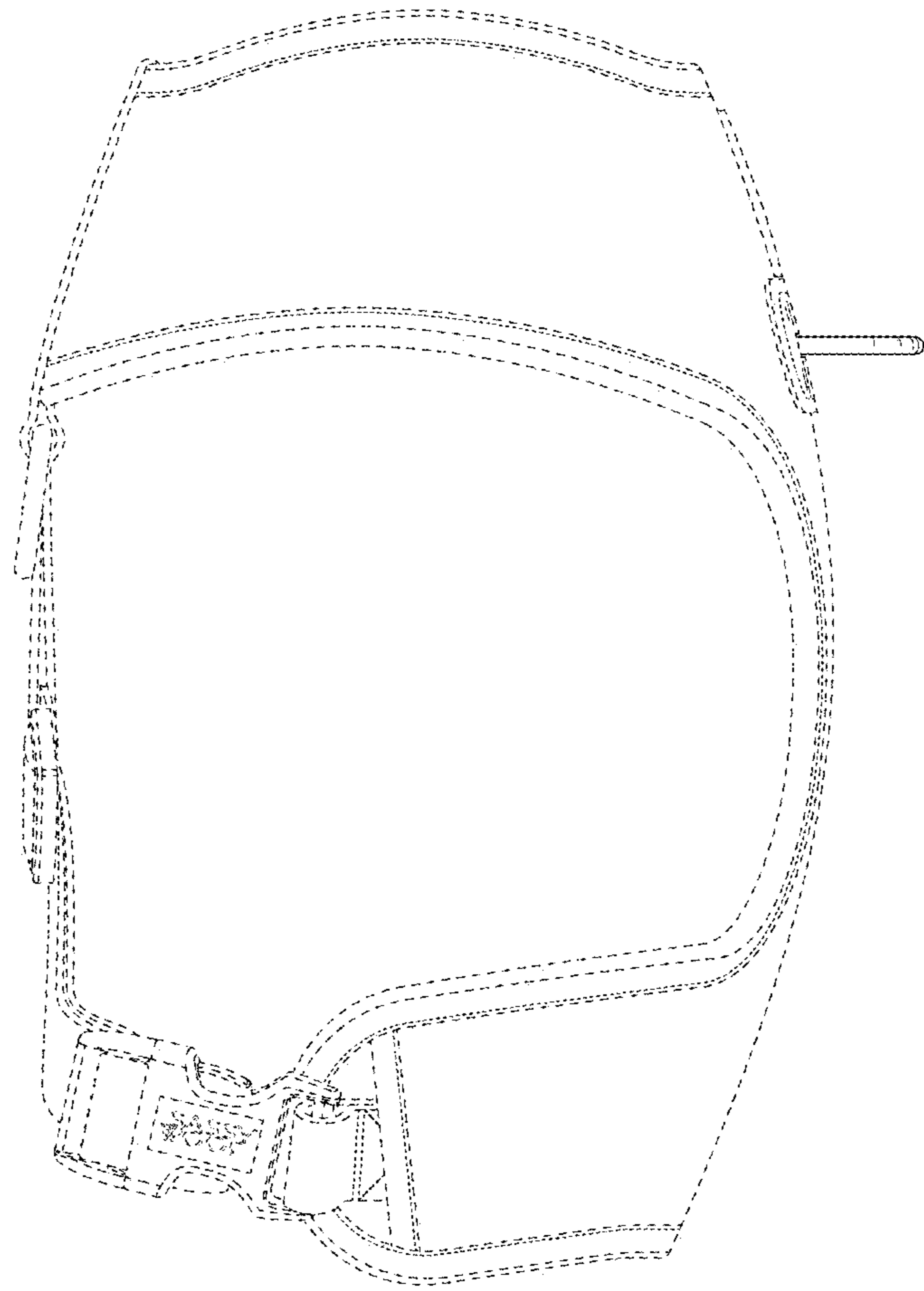

FIG. 7

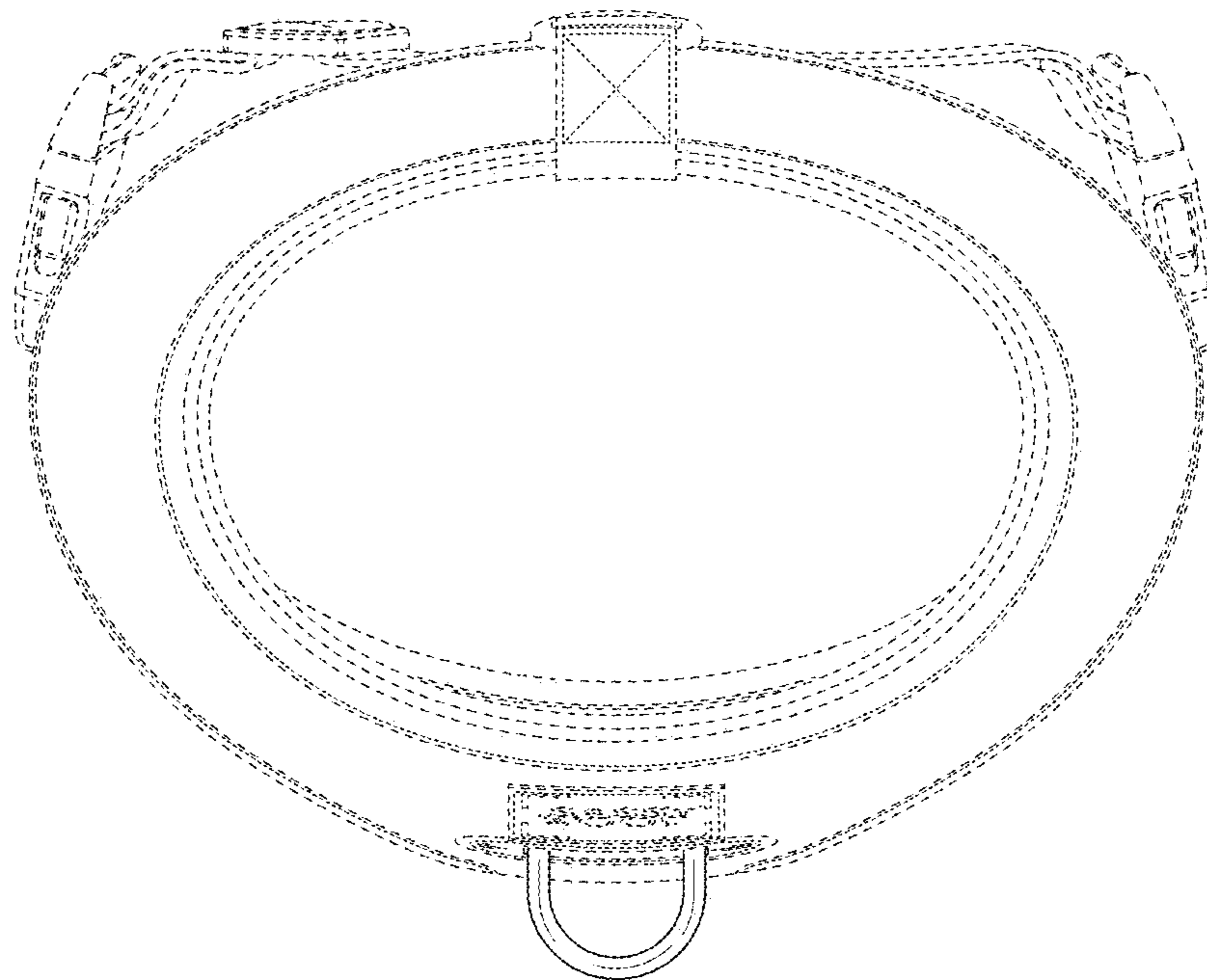

FIG. 8

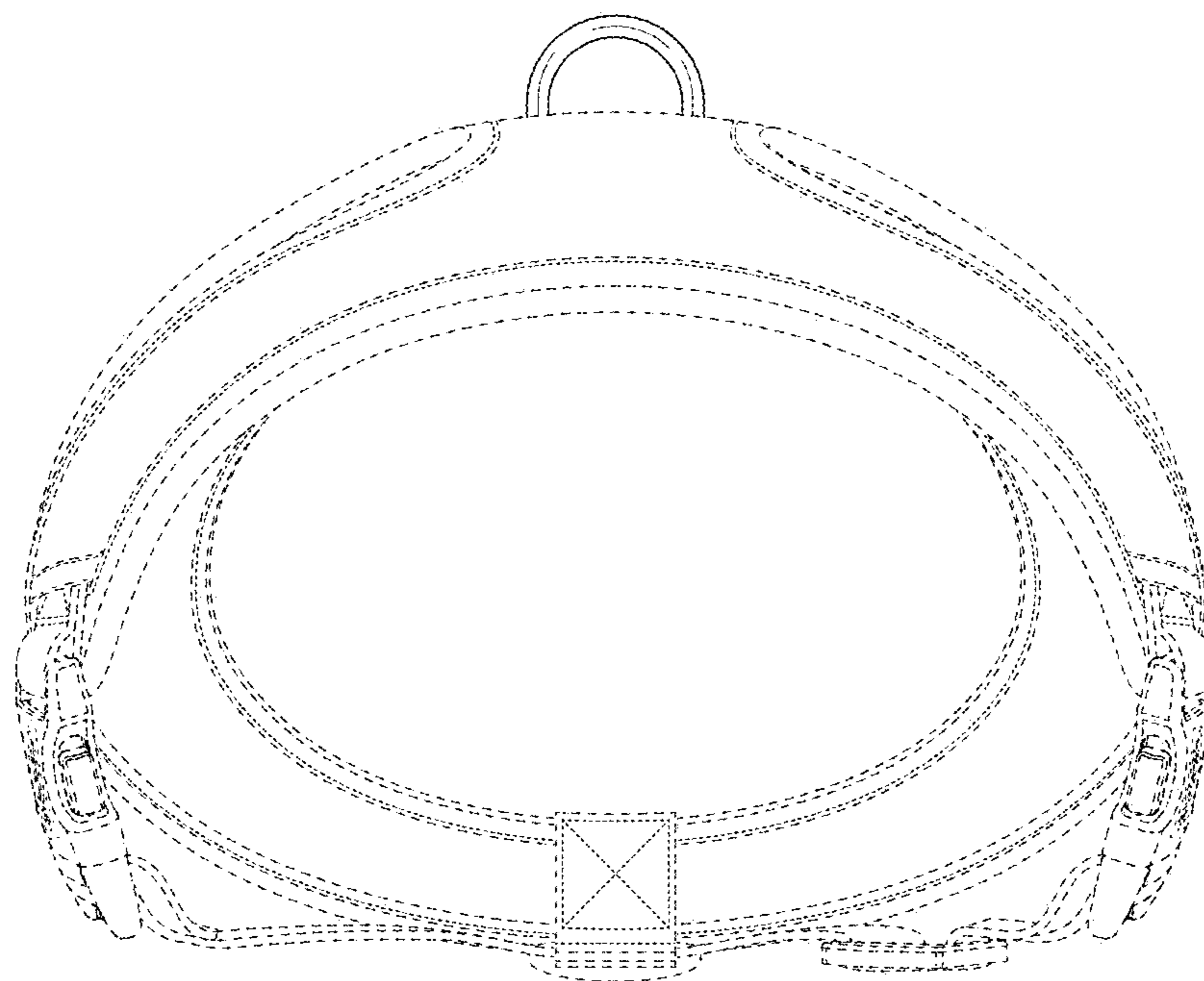

FIG. 9

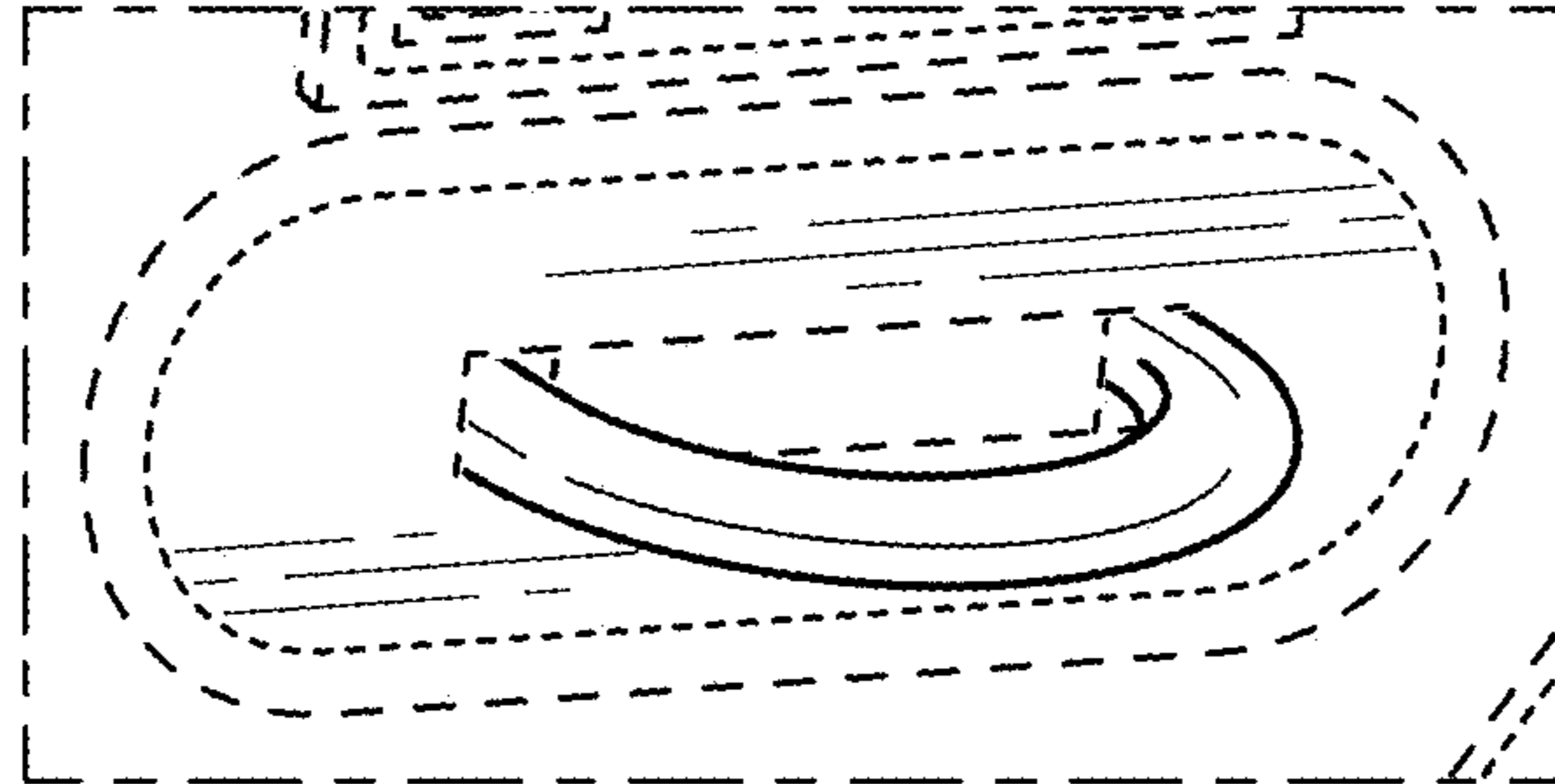

FIG. 10

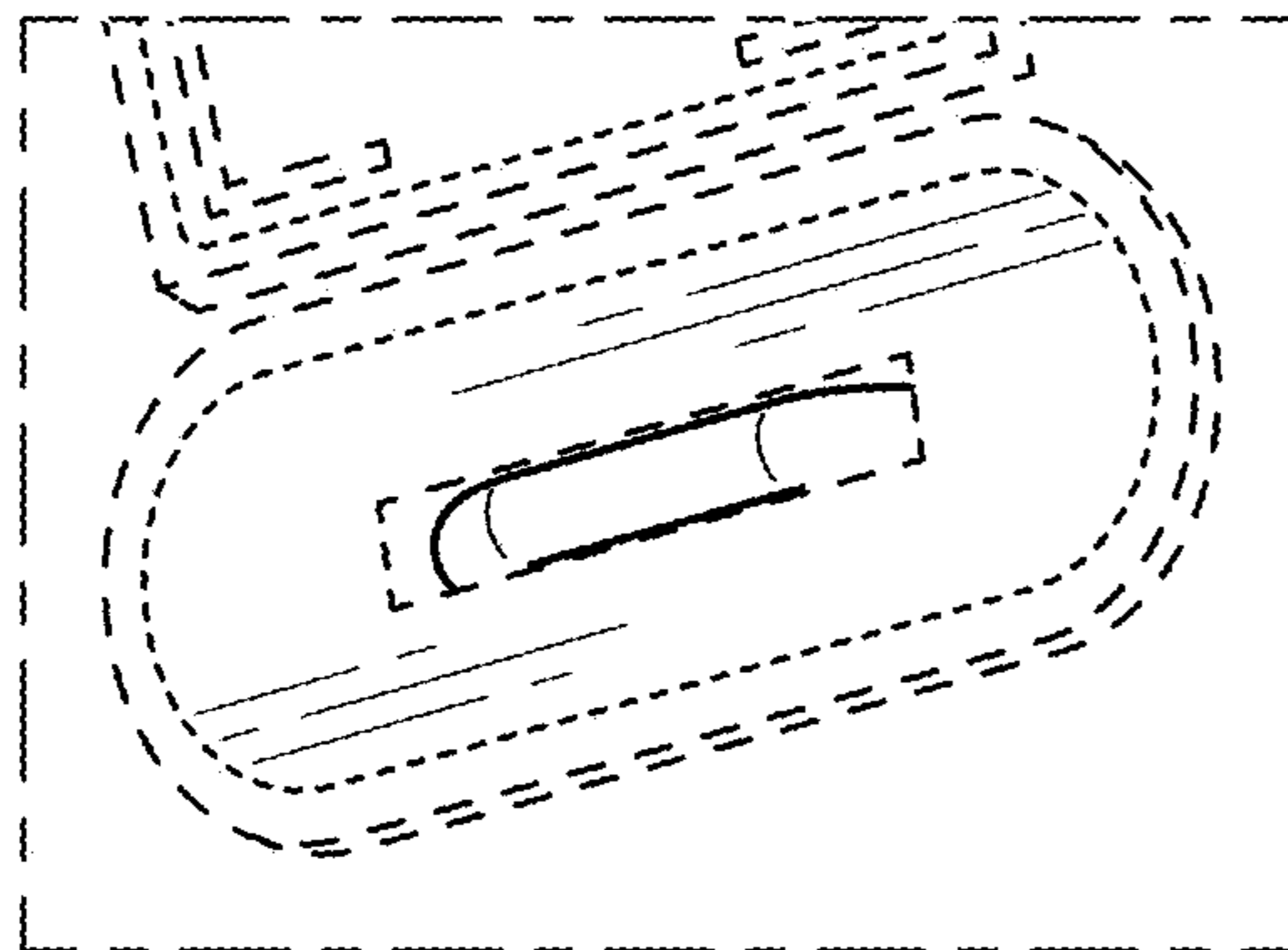

FIG. 11

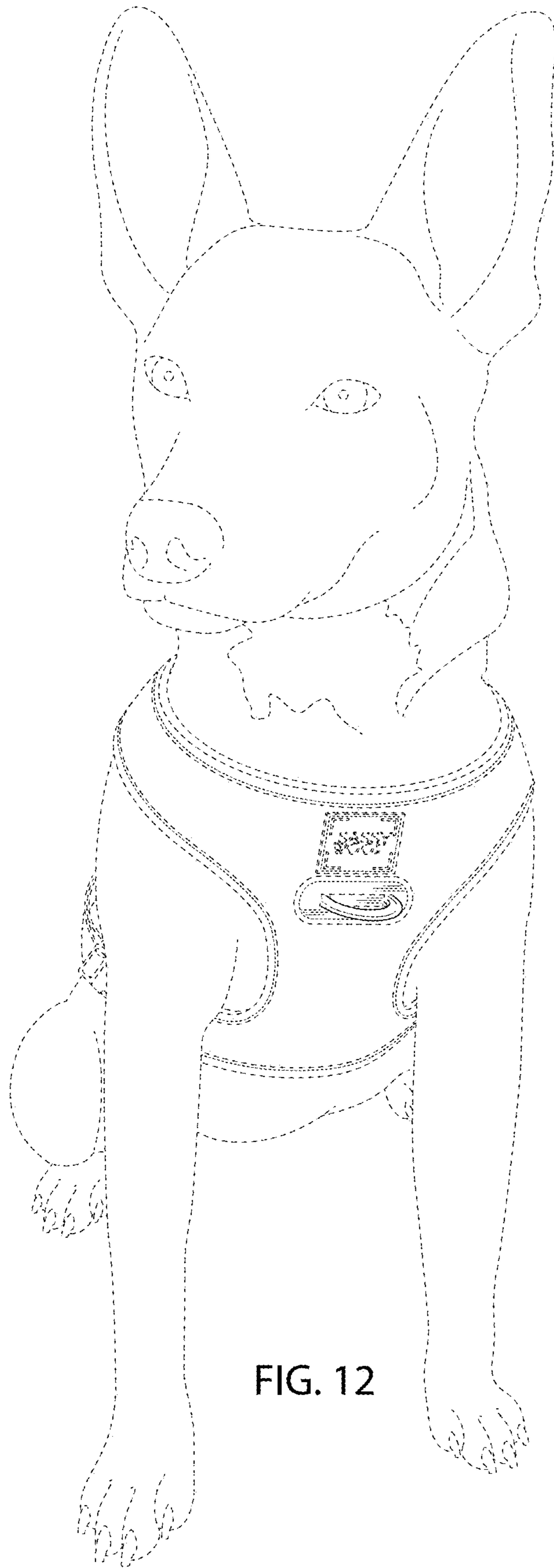

FIG. 12

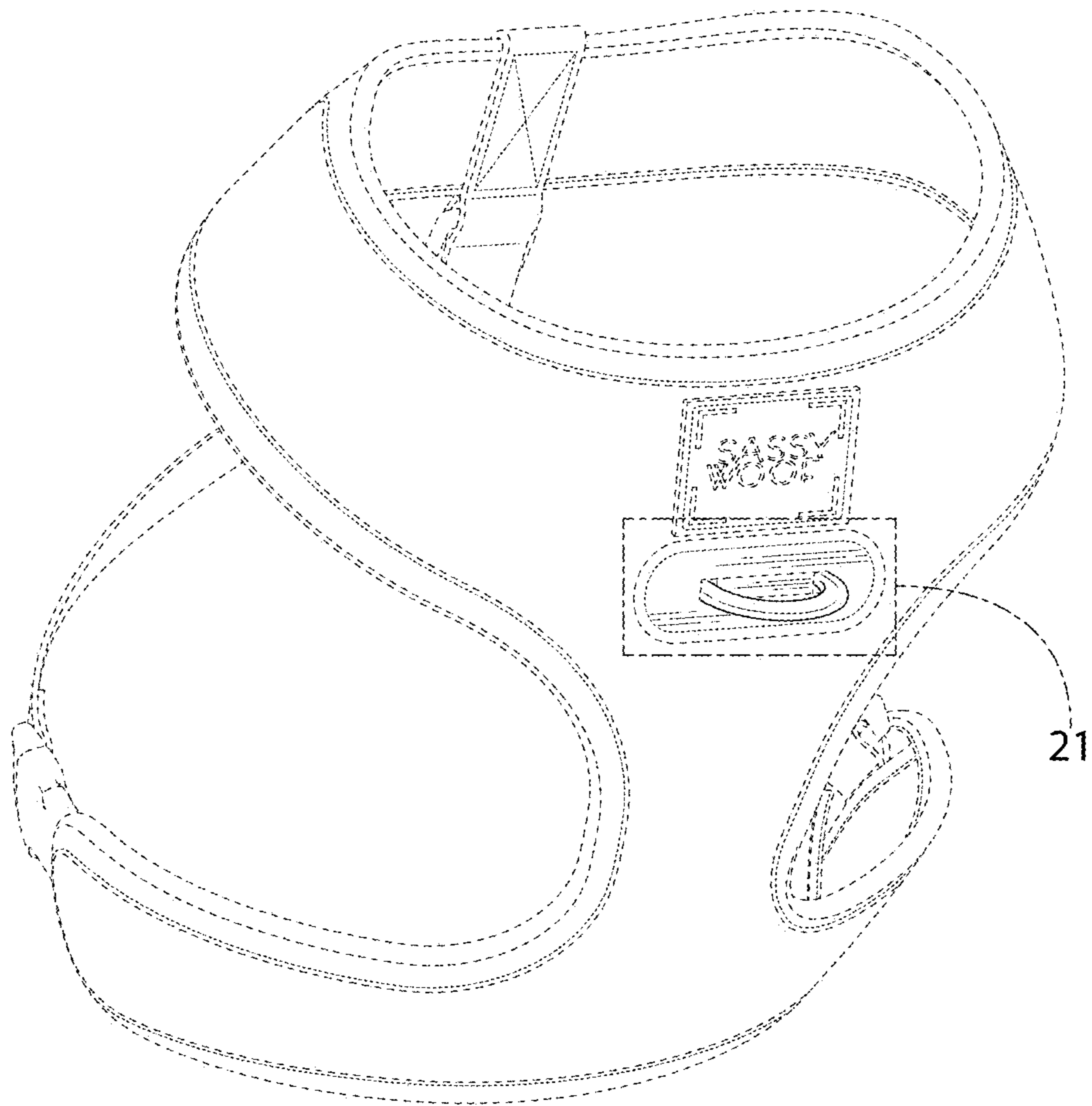

FIG. 13

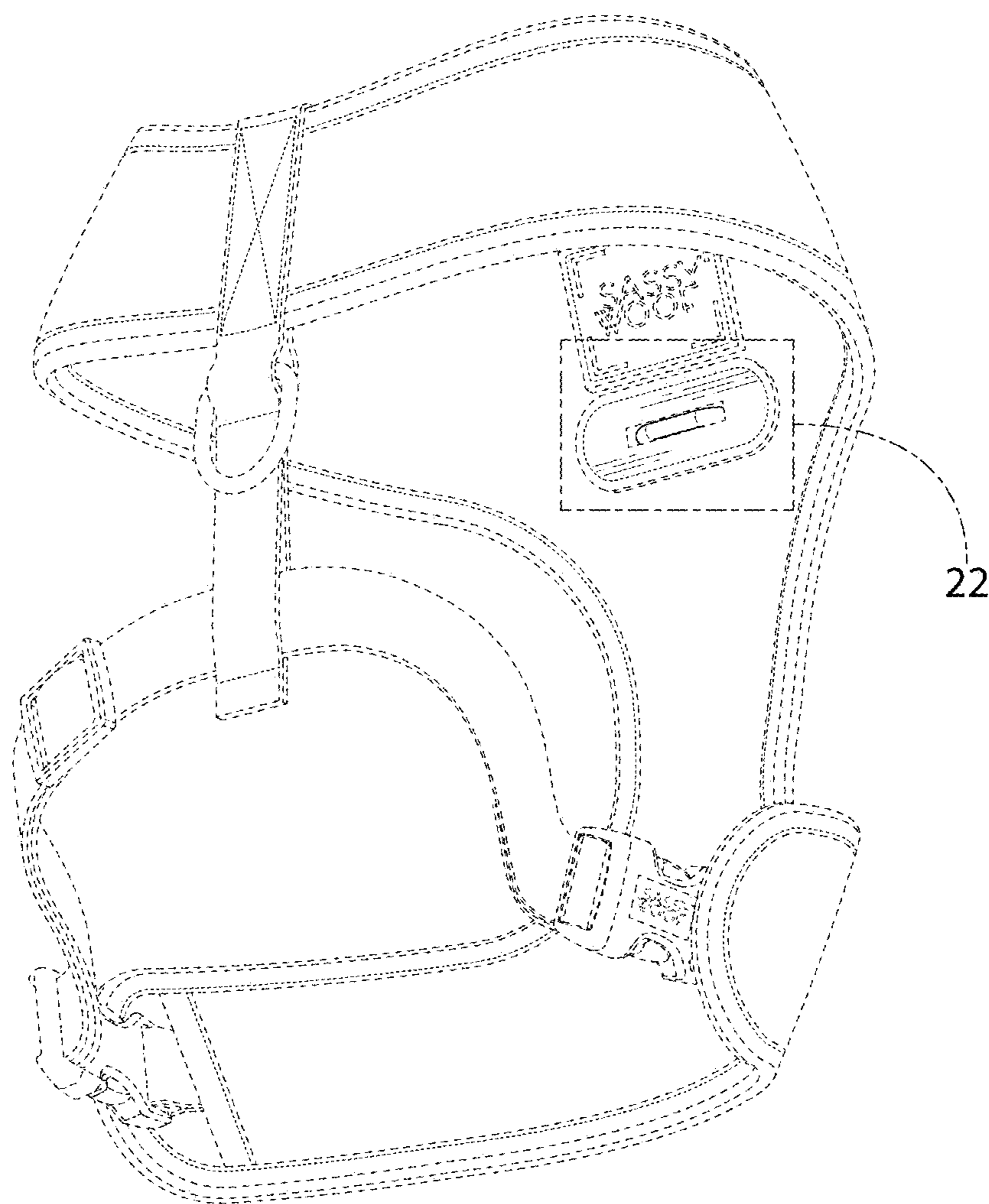

FIG. 14

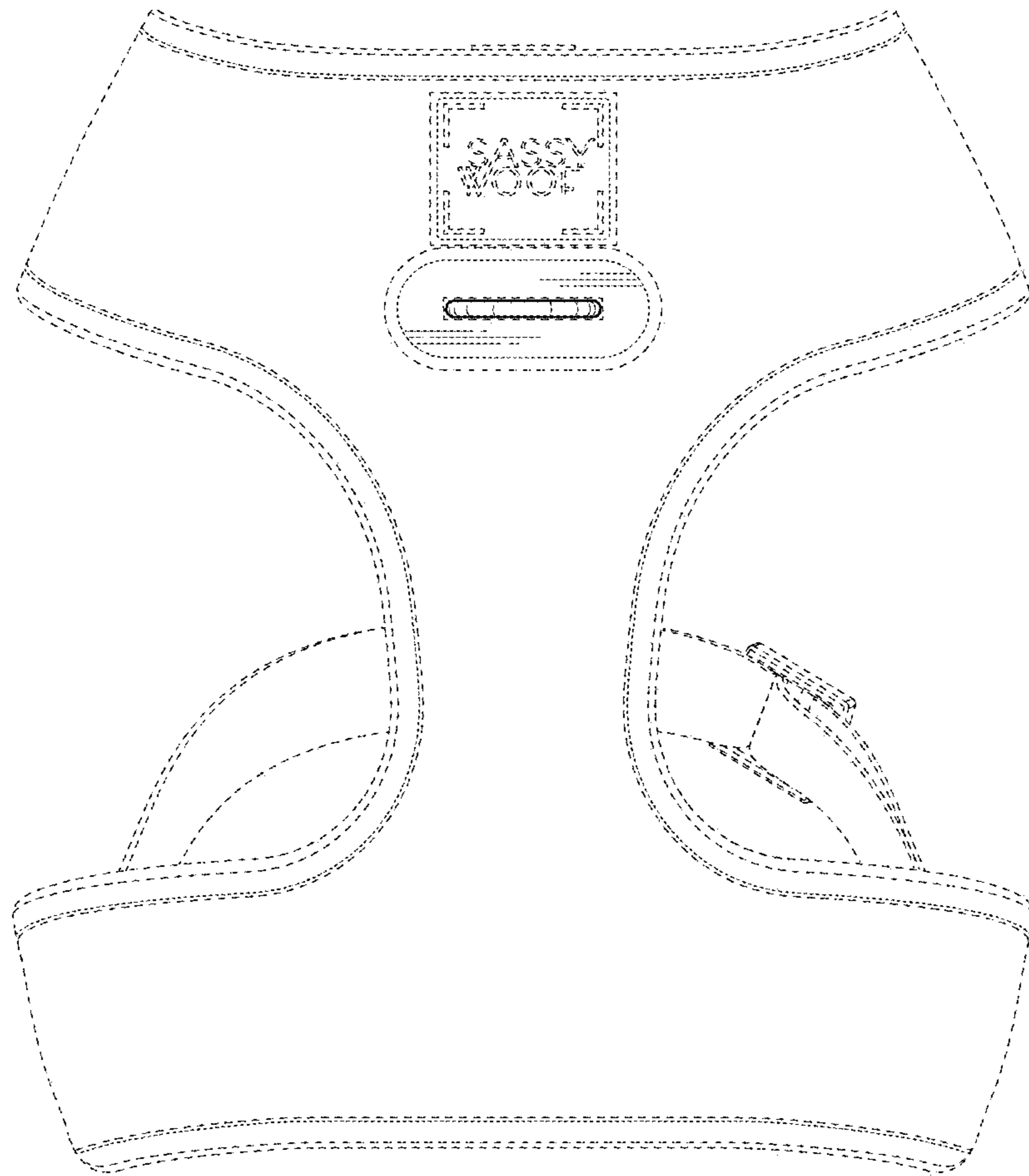

FIG. 15

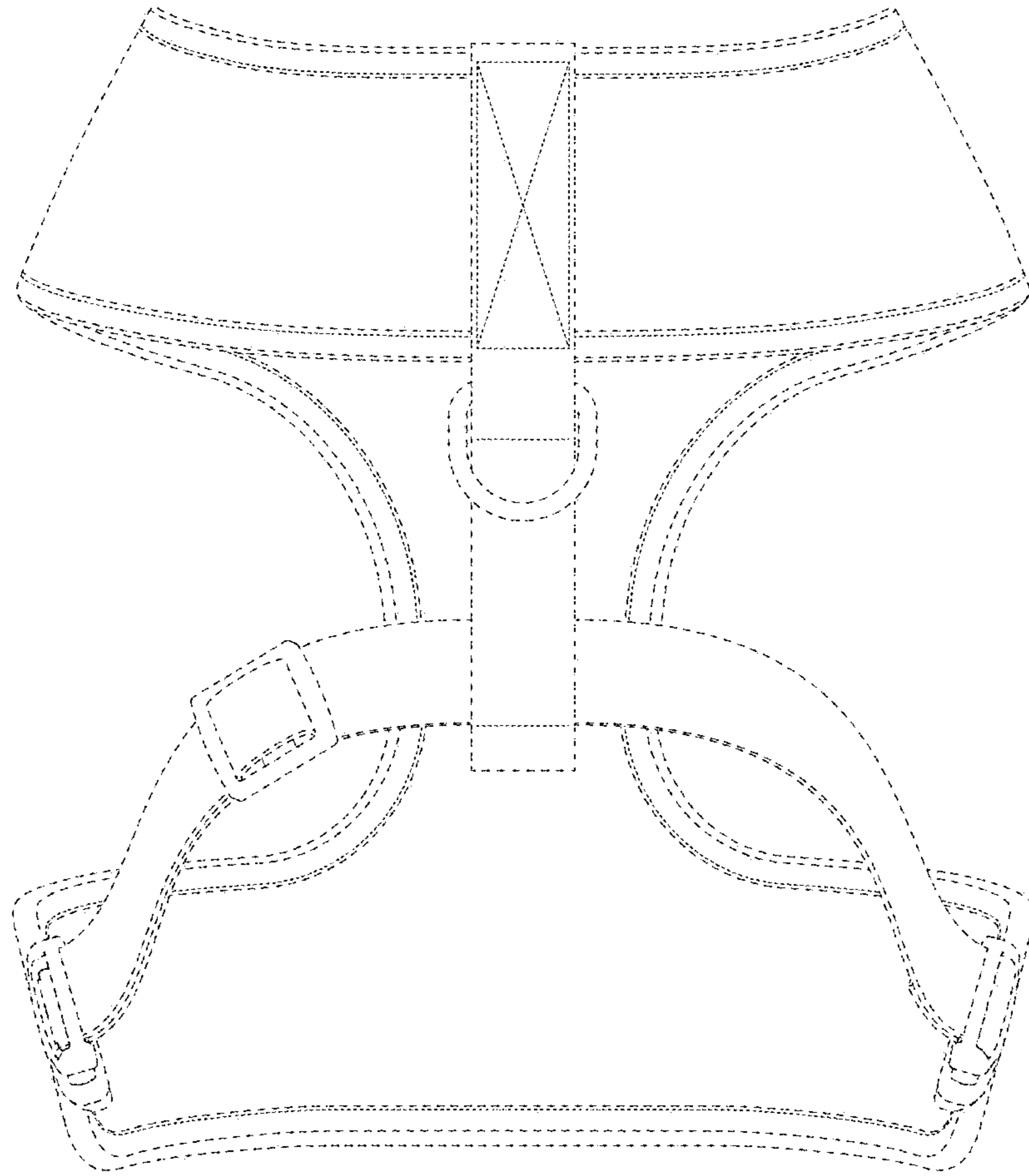

FIG. 16

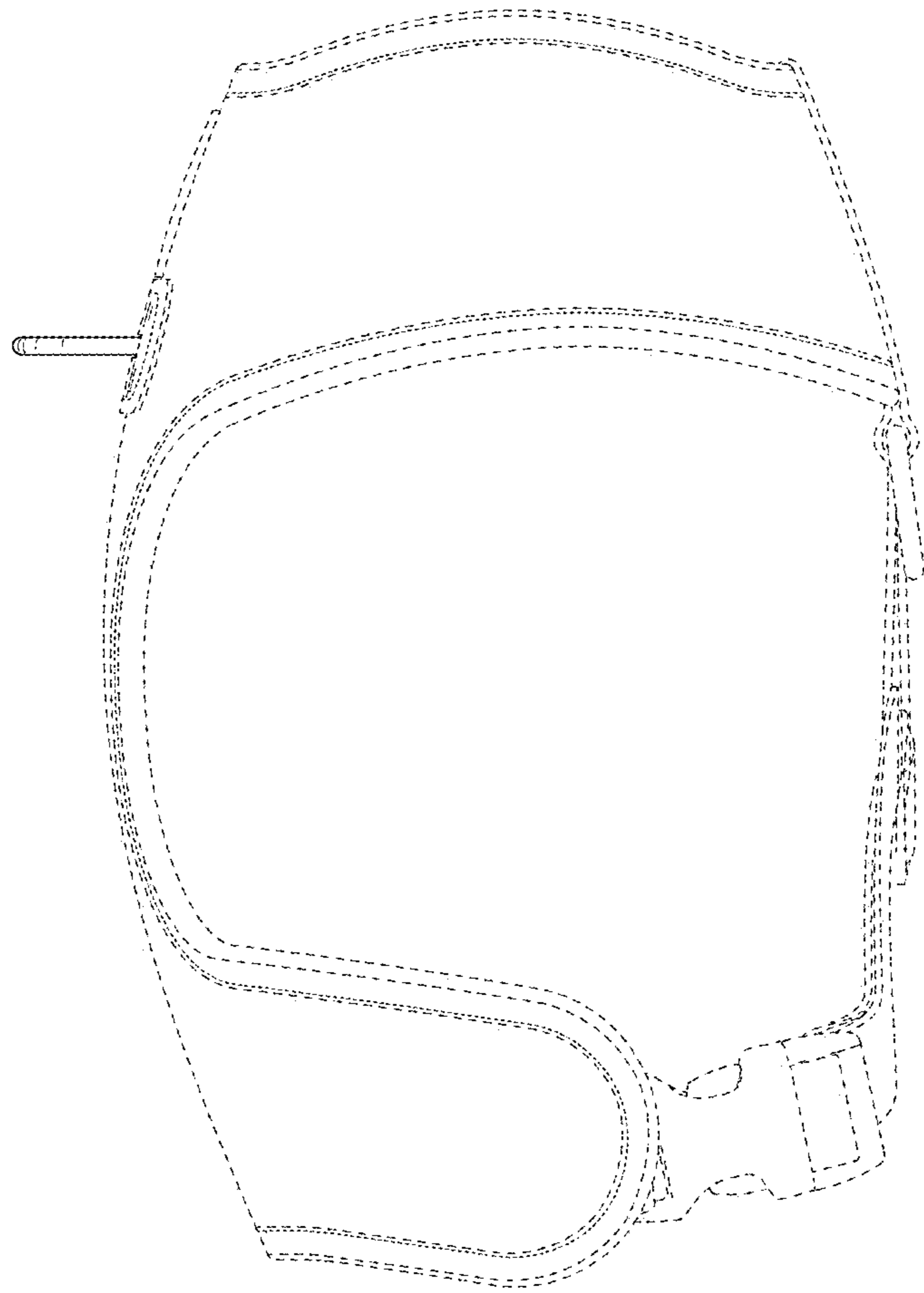

FIG. 17

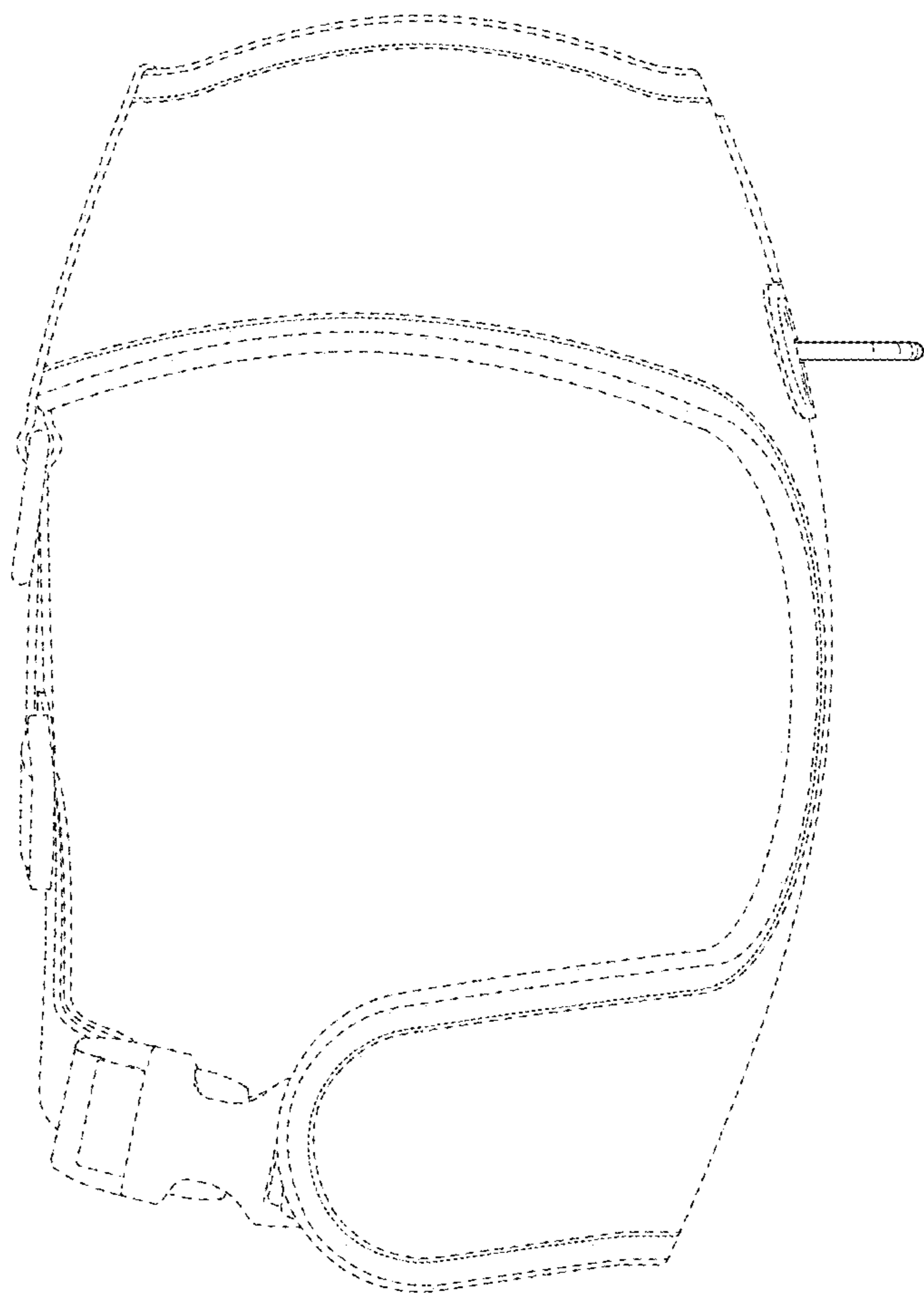

FIG. 18

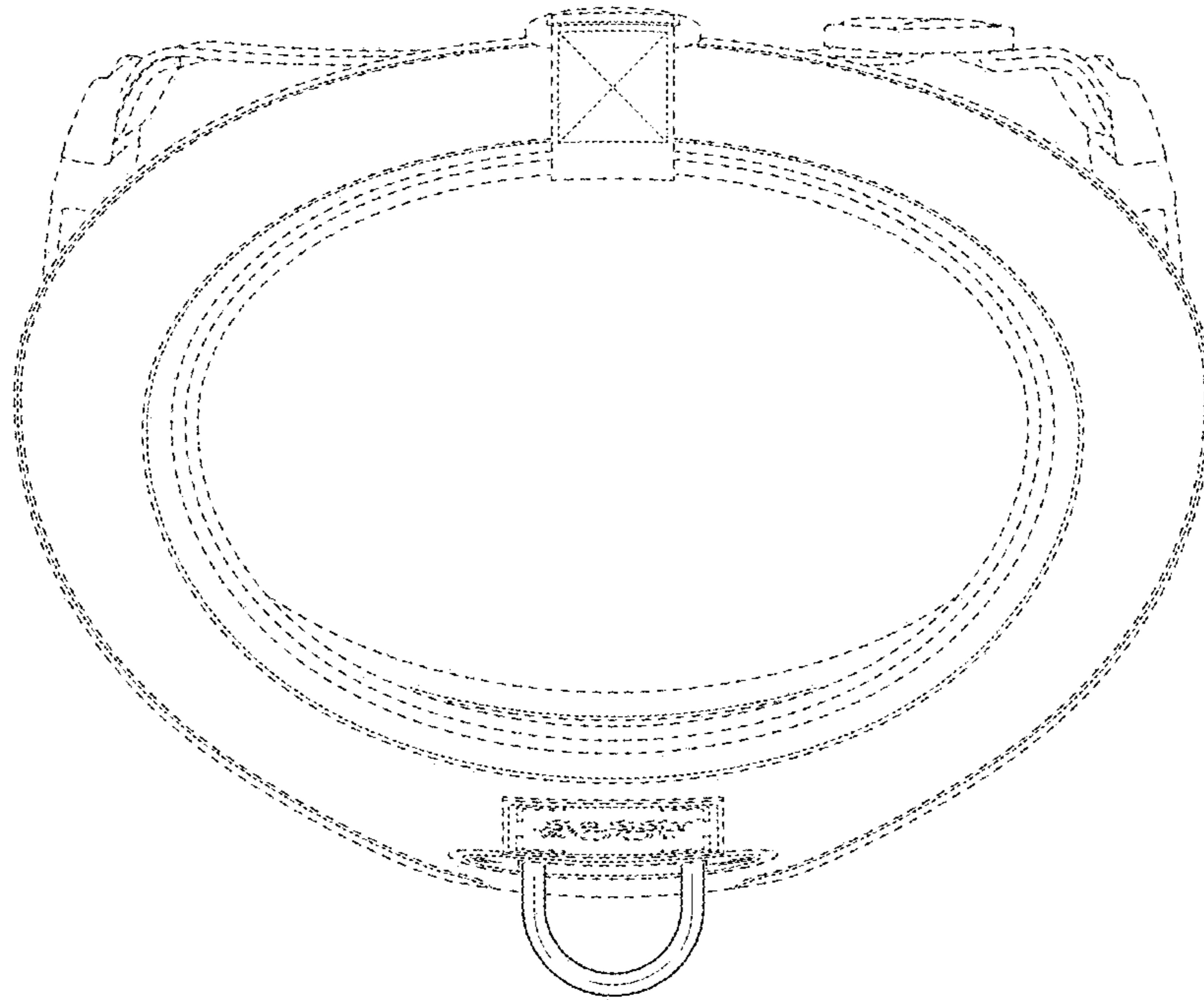

FIG. 19

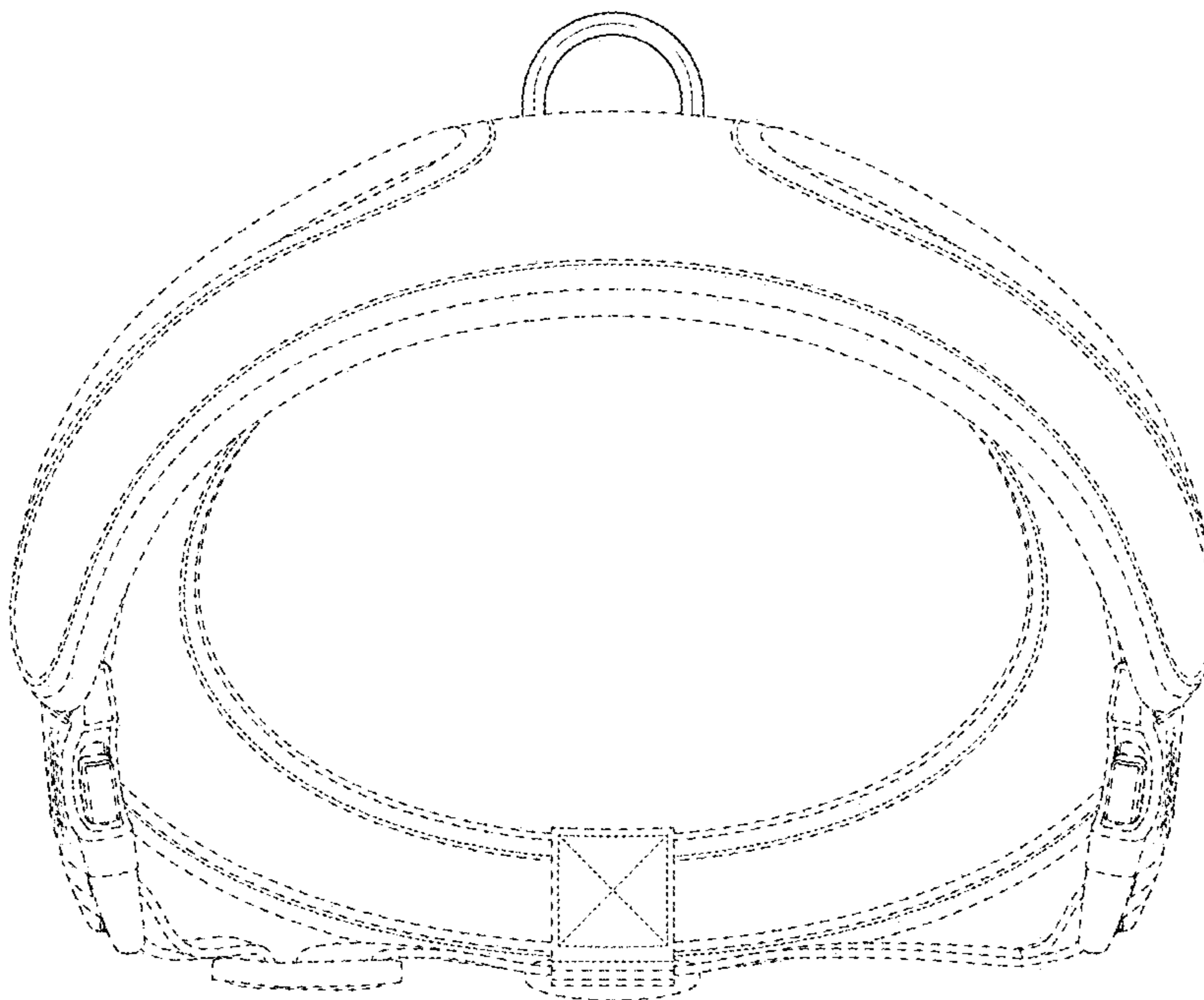

FIG. 20

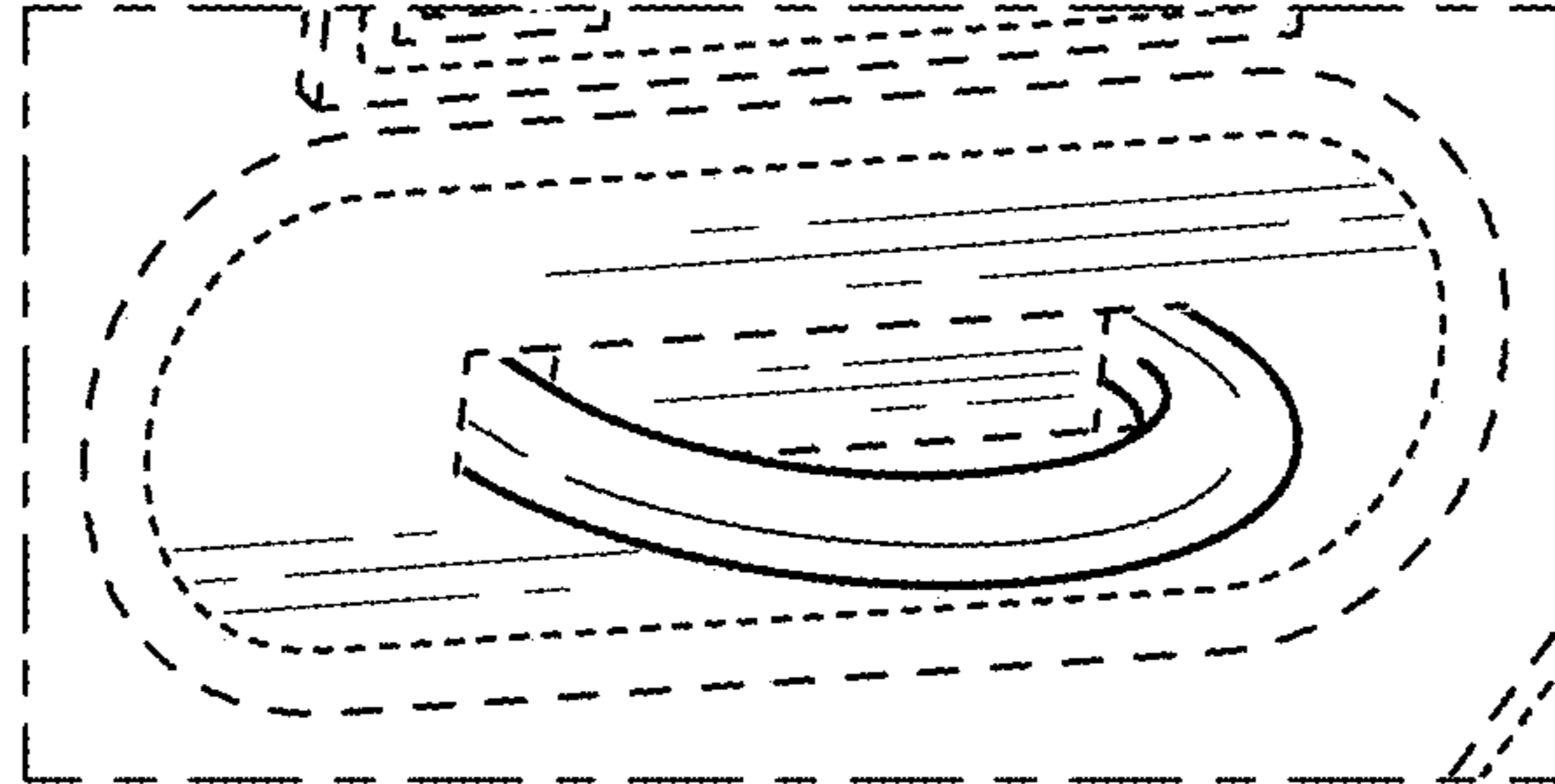

FIG. 21

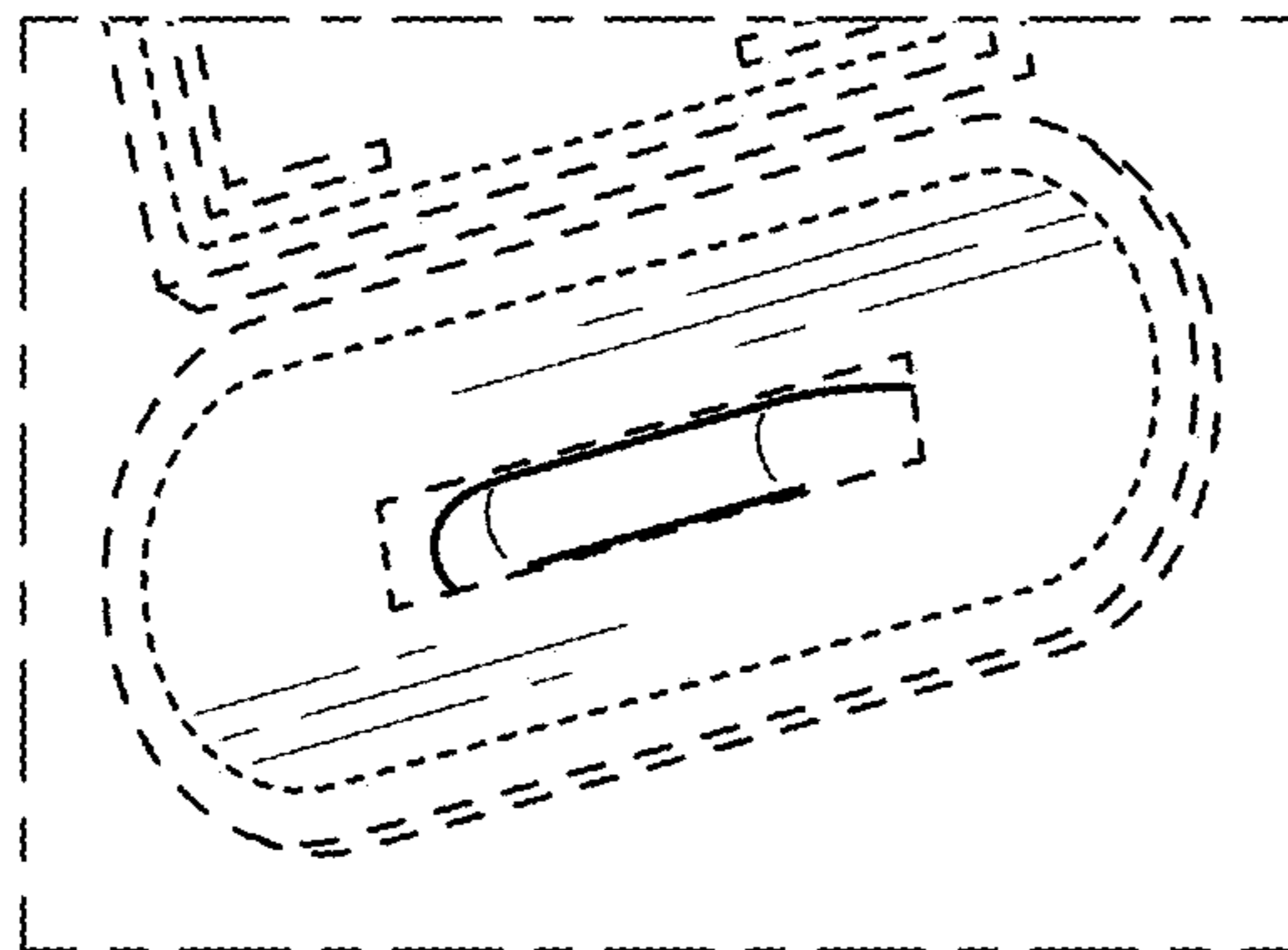

FIG. 22