



US00D947365S

(12) **United States Design Patent**
Eldibany

(10) **Patent No.:** **US D947,365 S**

(45) **Date of Patent:** **** Mar. 29, 2022**

(54) **FACE MASK**

(71) Applicant: **Mohamed Eldibany**, Evanston, IL (US)

(72) Inventor: **Mohamed Eldibany**, Evanston, IL (US)

(**) Term: **15 Years**

(21) Appl. No.: **29/754,116**

(22) Filed: **Oct. 6, 2020**

(51) **LOC (13) Cl.** **29-02**

(52) **U.S. Cl.**
USPC **D24/110.1**; D29/108

(58) **Field of Classification Search**
USPC D24/110, 110.1–110.6; D29/108
CPC . A41D 13/11; A41D 13/1107; A41D 13/1115;
A41D 13/1123; A41D 13/113; A41D
13/1138; A41D 13/1146; A41D 13/1153;
A41D 13/1161; A41D 13/1169; A41D
13/1176; A61M 16/06; A62B 18/00;
A62B 18/02; A62B 18/025; A62B 23/00
See application file for complete search history.

(56) **References Cited**

U.S. PATENT DOCUMENTS

D666,710	S	*	9/2012	Godfrey	D24/110
D767,115	S	*	9/2016	Mingo	D24/110.1
D936,207	S	*	11/2021	Mallady, Jr.	D24/110.1
D936,208	S	*	11/2021	Bindhammer	D29/108
D936,906	S	*	11/2021	Xin	D29/108
2014/0224261	A1	*	8/2014	Tsuei	A62B 23/025
						156/159
2015/0173436	A1	*	6/2015	Tsuei	A41D 13/113
						2/424
2015/0216241	A1	*	8/2015	Lee	A41D 13/1192
						128/863
2016/0029716	A1	*	2/2016	Duncan	A41D 13/11
						128/863
2017/0209720	A1	*	7/2017	Mingo	A62B 23/025

2021/0368874	A1	*	12/2021	Eldibany	A62B 23/025
2022/0016296	A1	*	1/2022	Qian	A62B 18/025
2022/0016452	A1	*	1/2022	Weiss	A62B 18/086

FOREIGN PATENT DOCUMENTS

JP D1690654 * 7/2021

OTHER PUBLICATIONS

SipNParty (available [online] Oct. 17, 2020) Retrieved from the internet Jan. 28, 2022 from URL: <https://www.etsy.com/listing/868283242/mini-bandana-face-mask-in-black-sateen> (Year: 2020).*
Phlap (available [online]) Retrieved from the internet Jan. 28, 2022 from URL: <https://www.etsy.com/listing/804767058/face-mask-with-mouth-openingdrinking> (Year: 2022).*
SipNParty masks (available [online] Oct. 4, 2020) Retrieved from the internet Jan. 28, 2022 from URL: <https://www.instagram.com/p/CF6Gab0jWA1/> (Year: 2020).*

* cited by examiner

Primary Examiner — Richard Kearney

Assistant Examiner — Michael Hoffman

(74) *Attorney, Agent, or Firm* — Justin Lampel

(57) **CLAIM**

The ornamental design for a face mask, as shown and described.

DESCRIPTION

FIG. 1 is a perspective view of a face mask showing the claimed design;
FIG. 2 is a front view thereof;
FIG. 3 is a back view thereof;
FIG. 4 is a side view thereof;
FIG. 5 is a side view thereof;
FIG. 6 is a bottom view thereof;
FIG. 7 is a top view thereof; and,
FIG. 8 is a perspective view with the flap lifted upward.

1 Claim, 6 Drawing Sheets

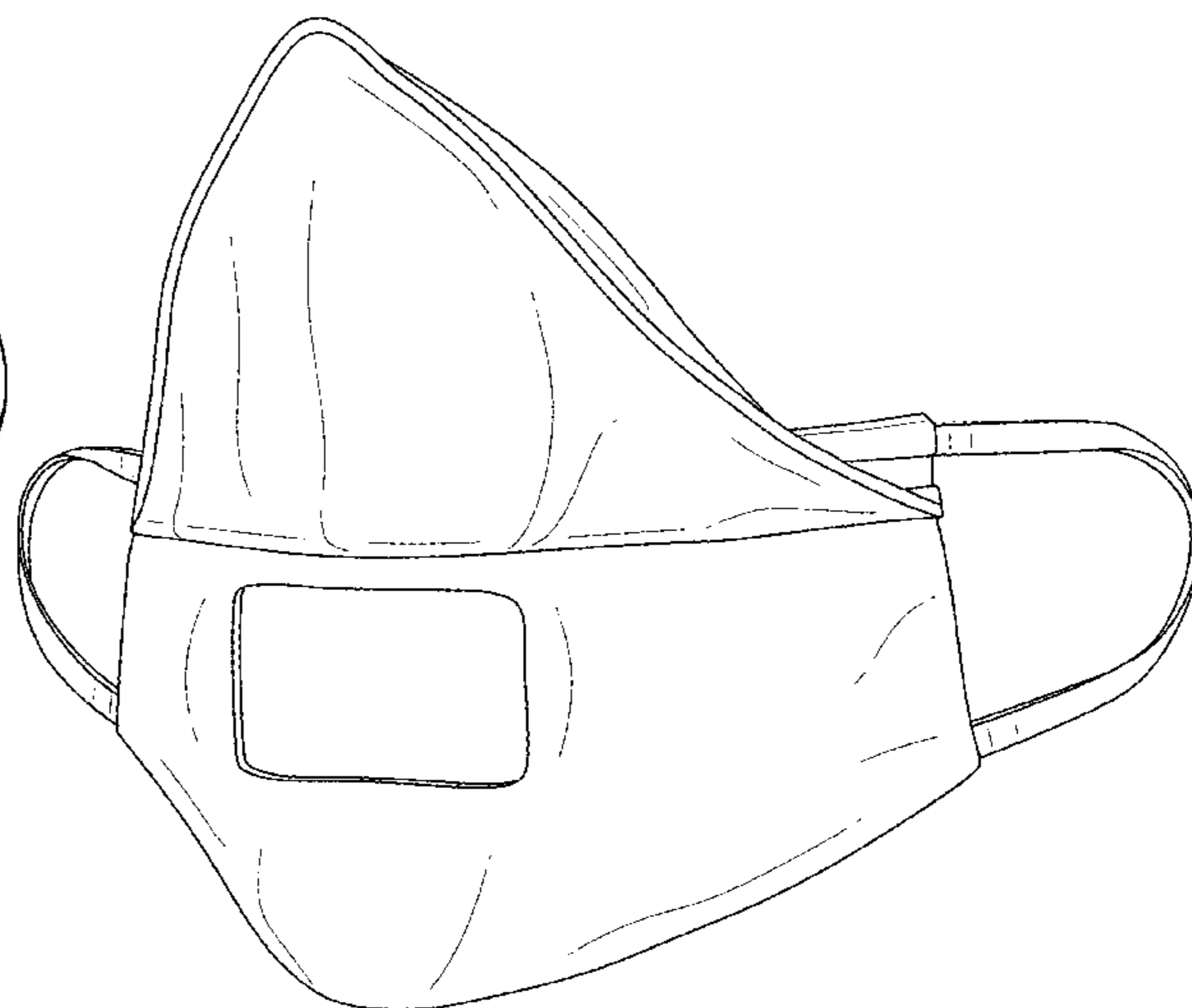
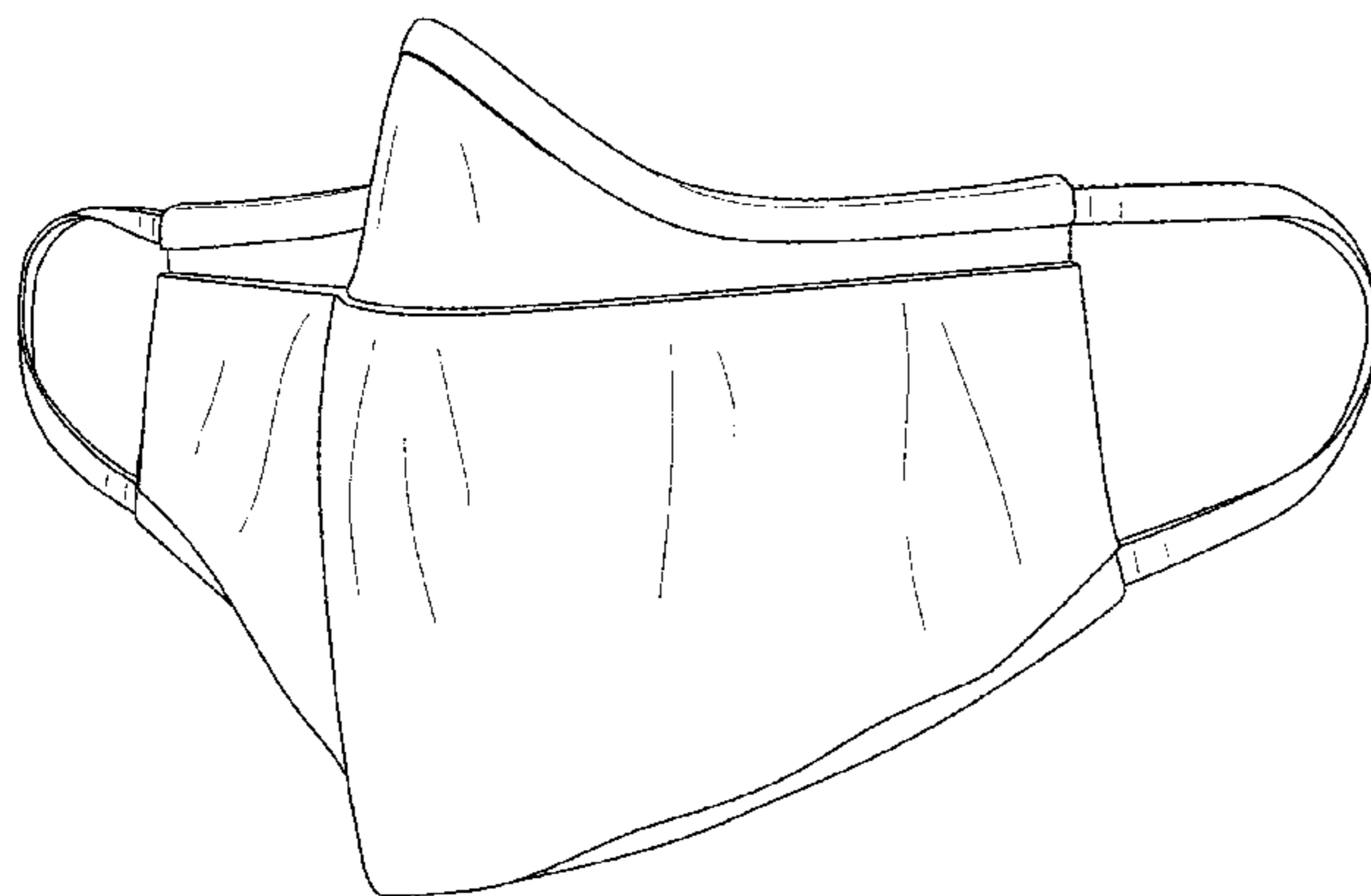



FIG. 1

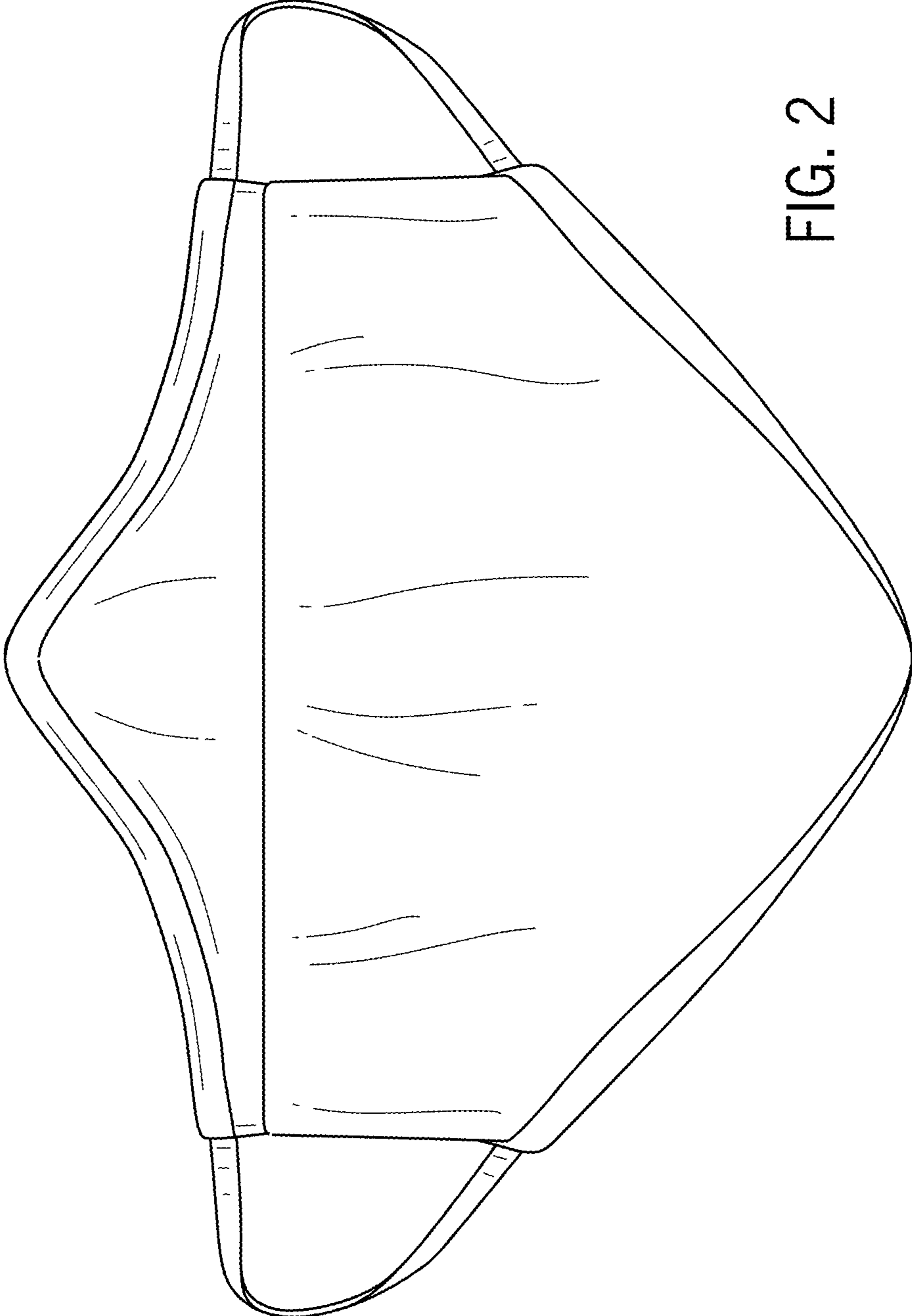

FIG. 2

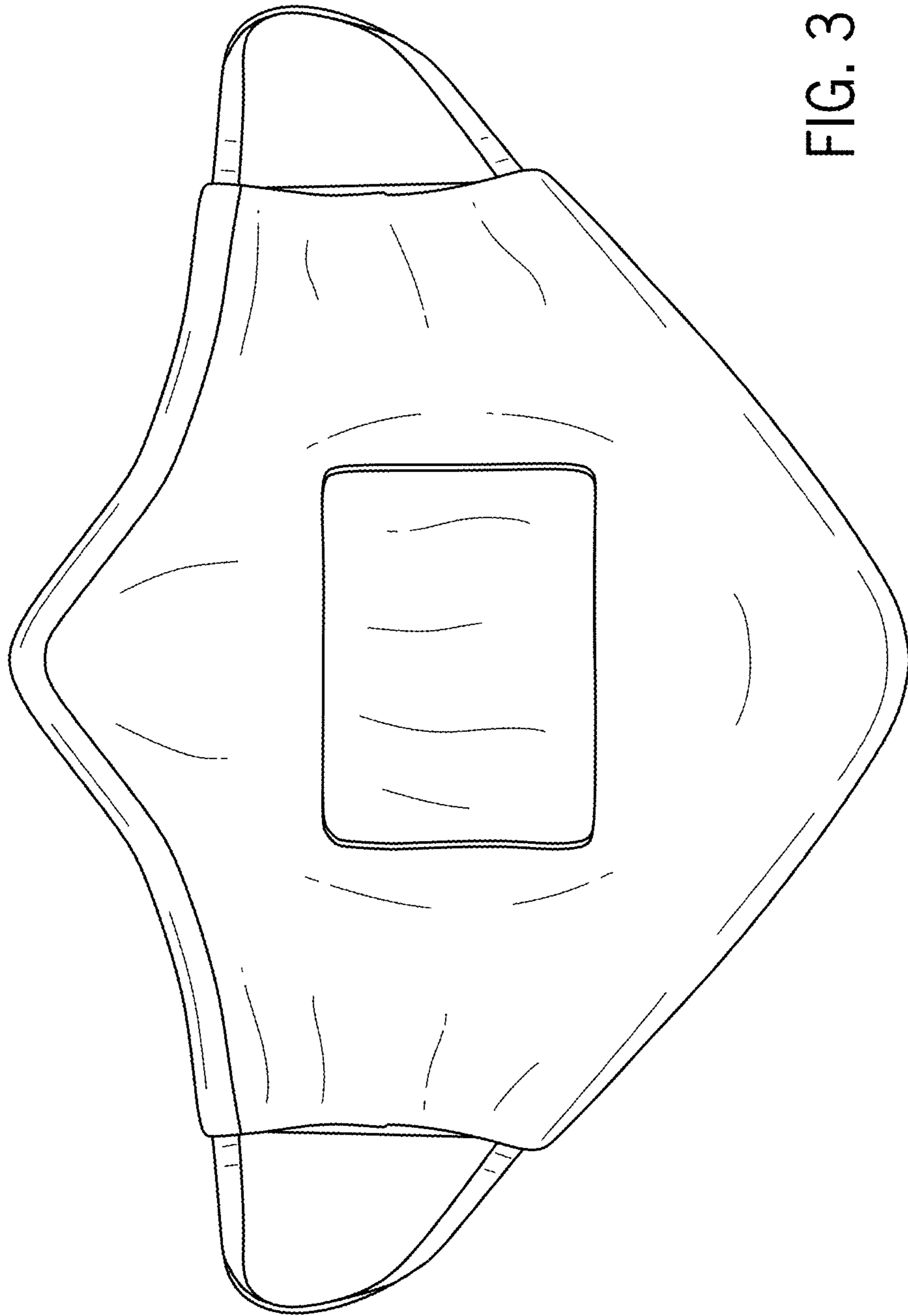

FIG. 3

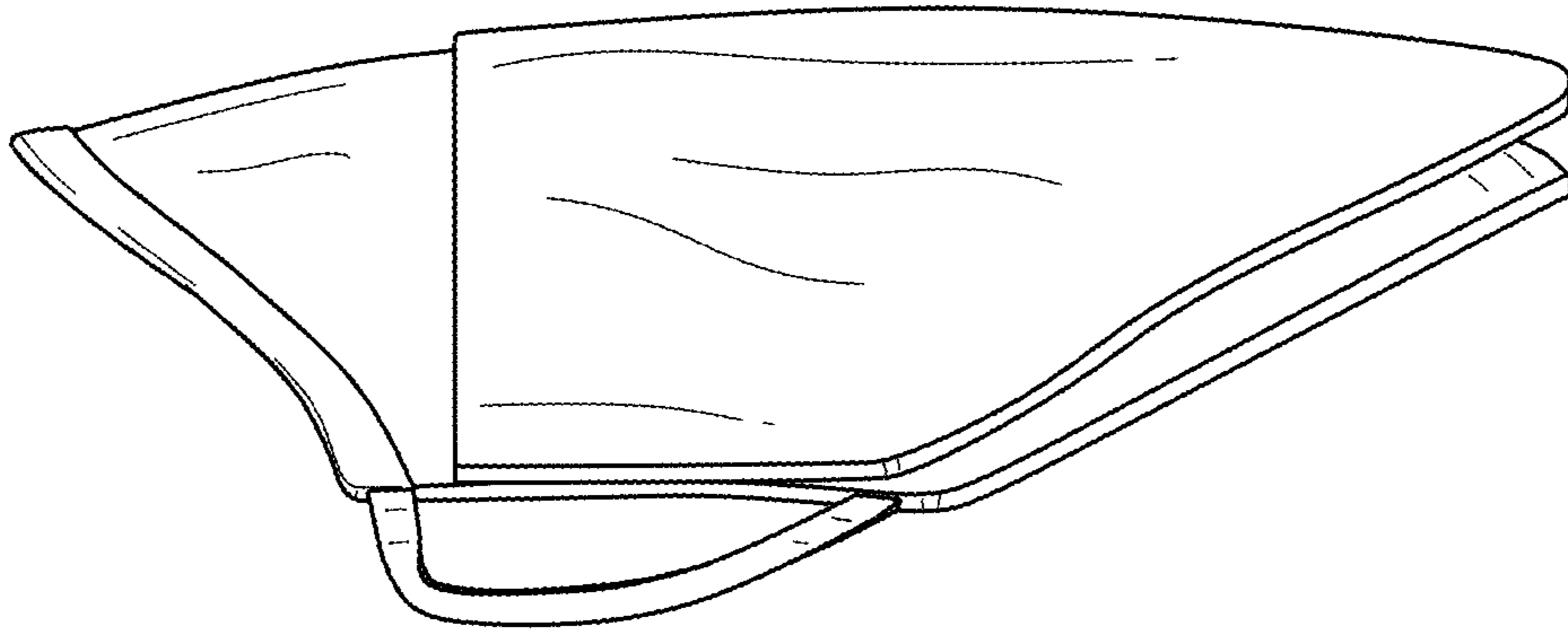

FIG. 5

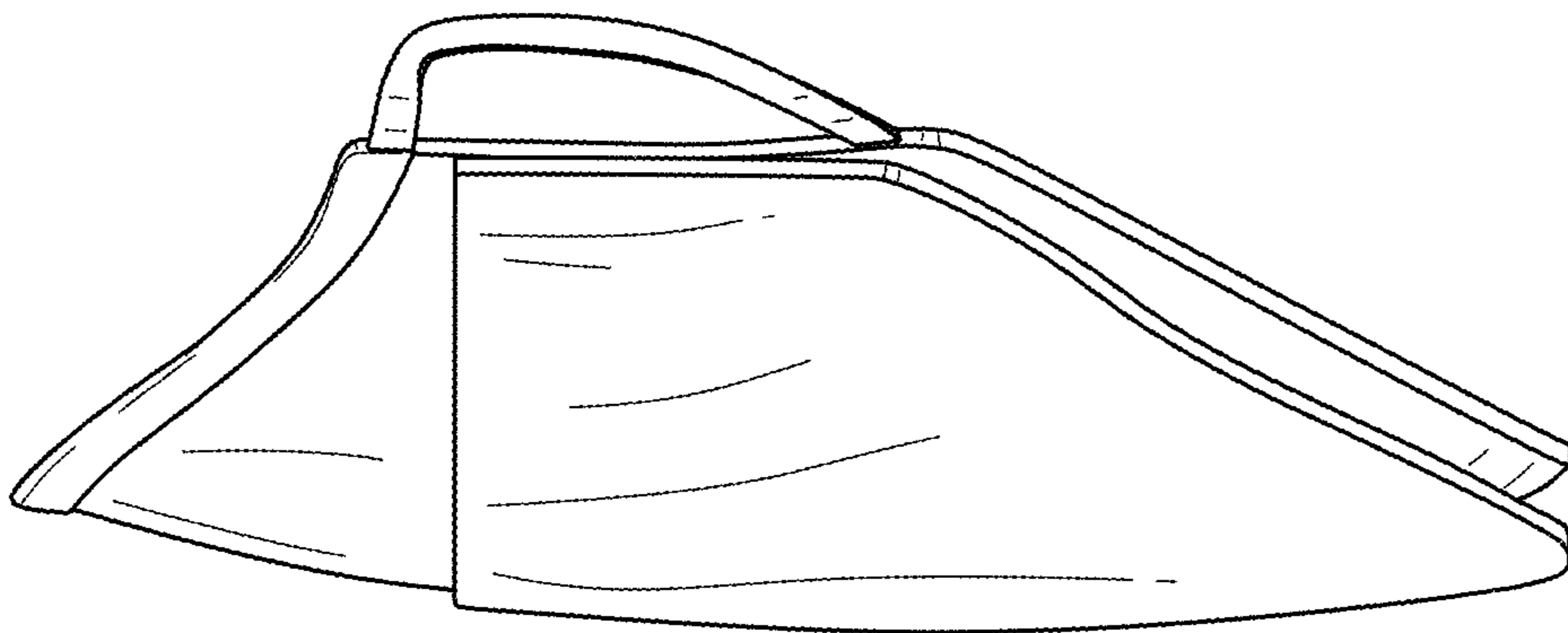

FIG. 4

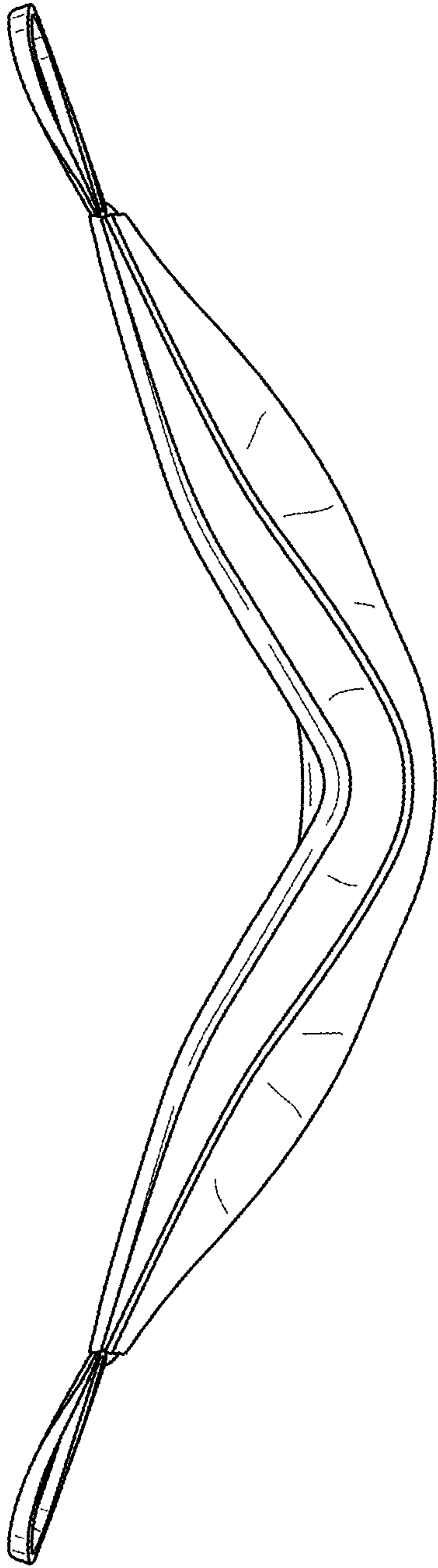

FIG. 6

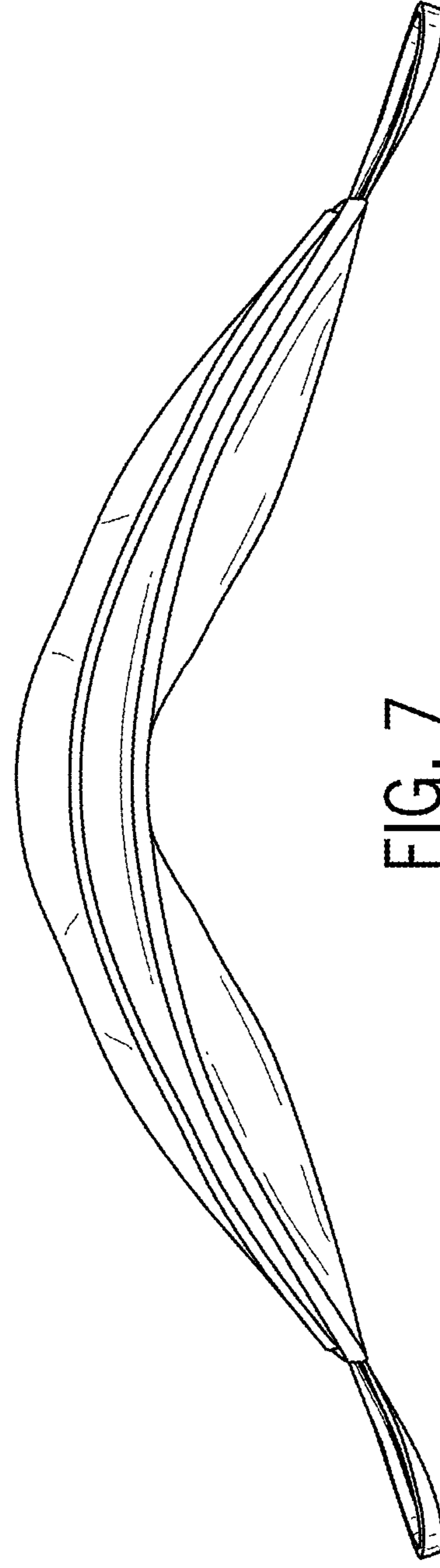

FIG. 7

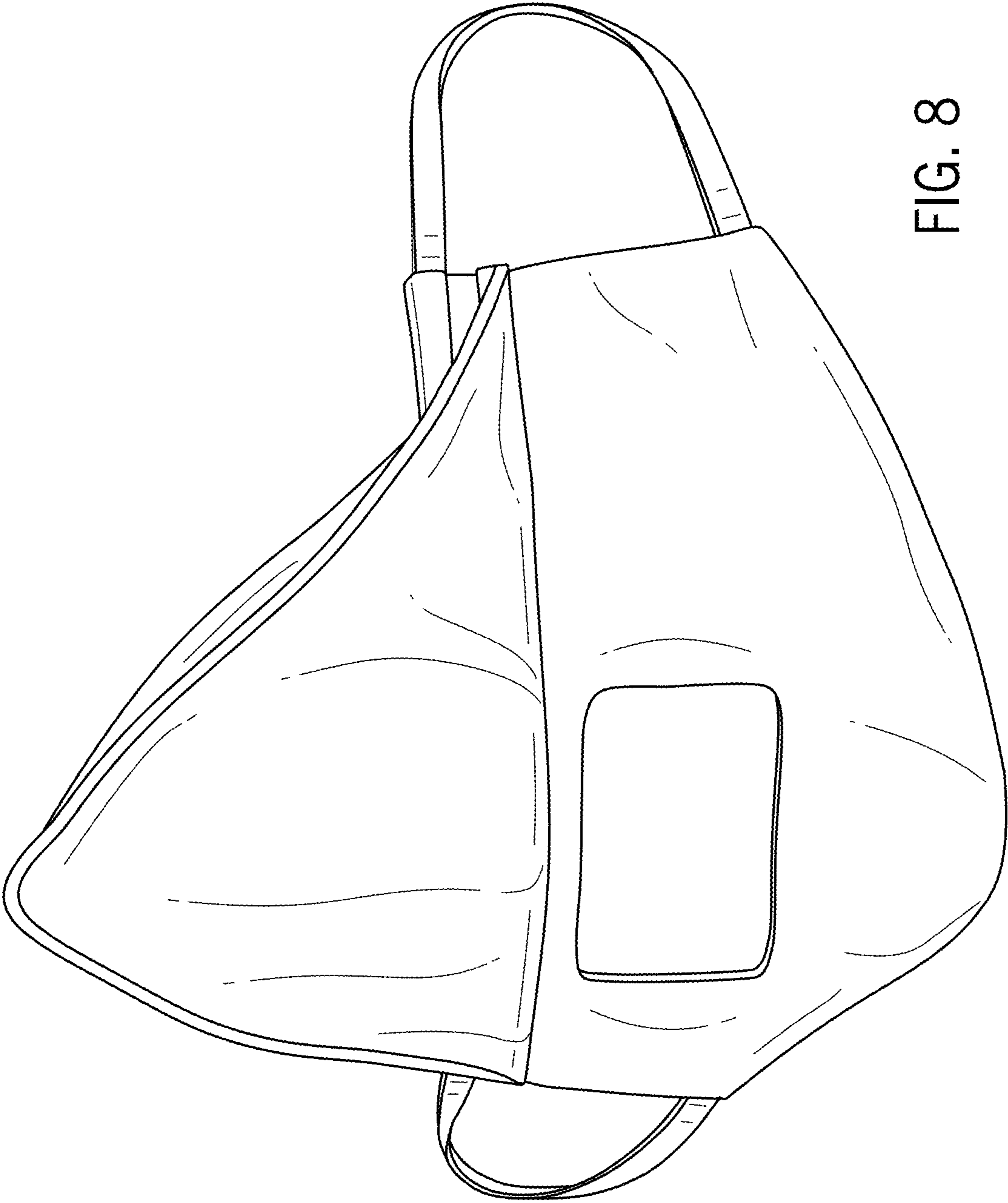

FIG. 8