



US00D947346S

(12) **United States Design Patent**
Mujica

(10) **Patent No.:** **US D947,346 S**

(45) **Date of Patent:** **** Mar. 29, 2022**

(54) **AIR PURIFIER**

(71) Applicant: **Pablo Garcia Mujica**, San Vicente del Raspeig (ES)

(72) Inventor: **Pablo Garcia Mujica**, San Vicente del Raspeig (ES)

(**) Term: **15 Years**

(21) Appl. No.: **35/511,032**

(22) Filed: **Dec. 8, 2020**

(80) **Hague Agreement Data**

Int. Filing Date: **Dec. 8, 2020**

Int. Reg. No.: **DM/211798**

Int. Reg. Date: **Dec. 8, 2020**

Int. Reg. Pub. Date: **Dec. 25, 2020**

(51) **LOC (13) Cl.** **23-04**

(52) **U.S. Cl.**
USPC **D23/364**

(58) **Field of Classification Search**

USPC D23/355, 356, 359, 364, 370, 386

CPC B01D 46/00; B01D 46/0002; A61L 9/00;

F24F 8/10; F24F 3/16; F24F 1/0071;

F24F 13/082; F24F 1/0014; F24F 1/02

See application file for complete search history.

(56) **References Cited**

U.S. PATENT DOCUMENTS

D314,819 S * 2/1991 Thompson D23/364

D544,948 S * 6/2007 Spiegel D23/364

D569,491 S * 5/2008 DeForte D23/386
D603,951 S * 11/2009 Seidler D23/370
D799,018 S * 10/2017 Kim D23/366
D810,259 S * 2/2018 You D23/364
D889,620 S * 7/2020 Victorin D23/364
D930,804 S * 9/2021 Kyung D23/364
11,229,866 B2 * 1/2022 Murayama B01D 46/42

* cited by examiner

Primary Examiner — Michael A. Pratt

(57) **CLAIM**

The ornamental design for an air purifier, as shown and described.

DESCRIPTION

- 1. Air purifier
- 1.1 : Perspective
- 1.2 : Front
- 1.3 : Back
- 1.4 : Left
- 1.5 : Right
- 1.6 : Top
- 1.7 : Bottom

Ceiling-mounted air purifying appliance for destruction of microorganisms, bacteria and viruses, as shown in view 1.1 (perspective view), which contains a characteristic general shape, as shown.

1 Claim, 7 Drawing Sheets

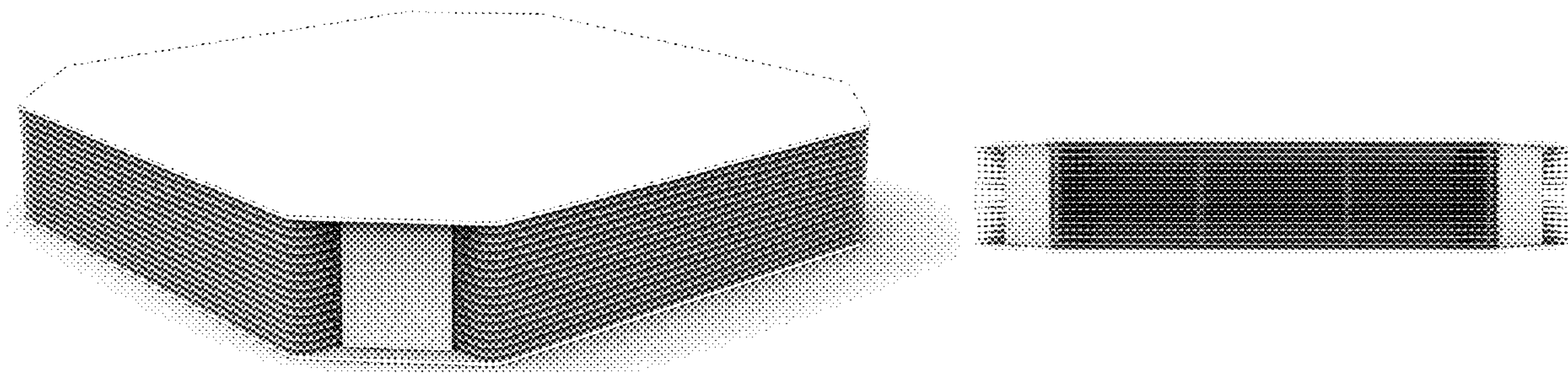

1.1

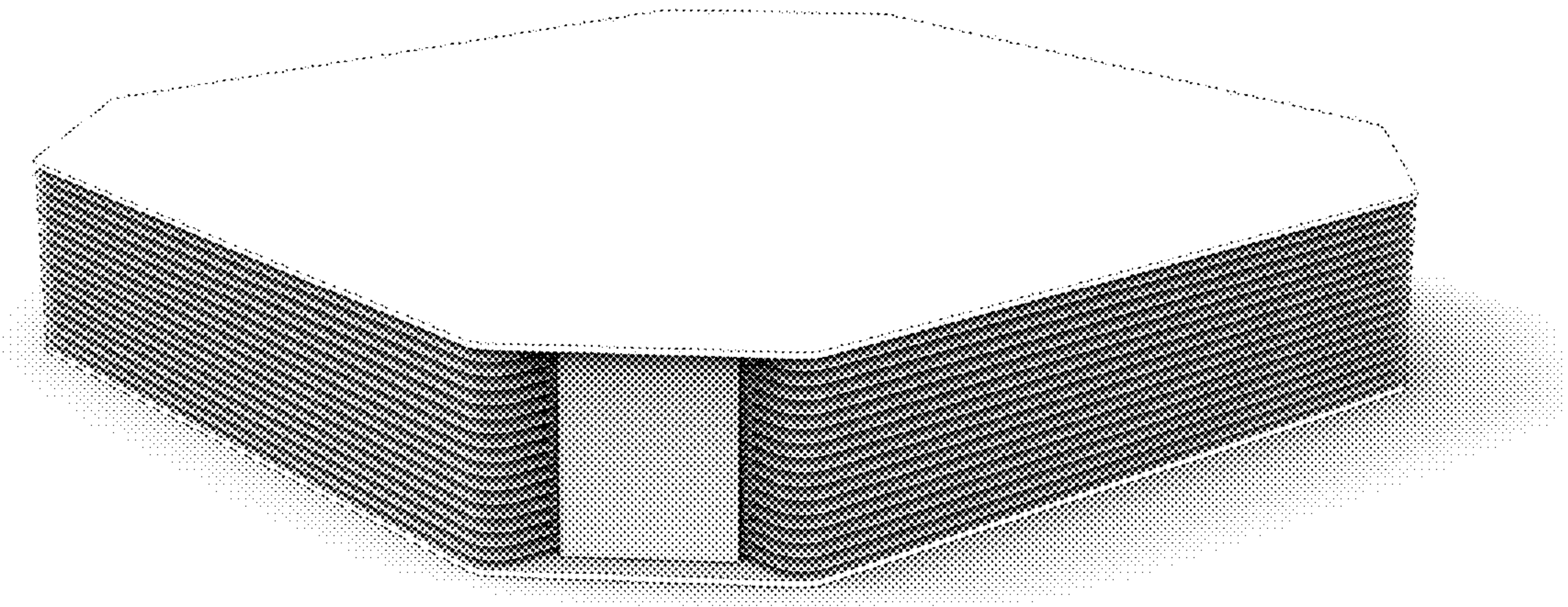

1.2

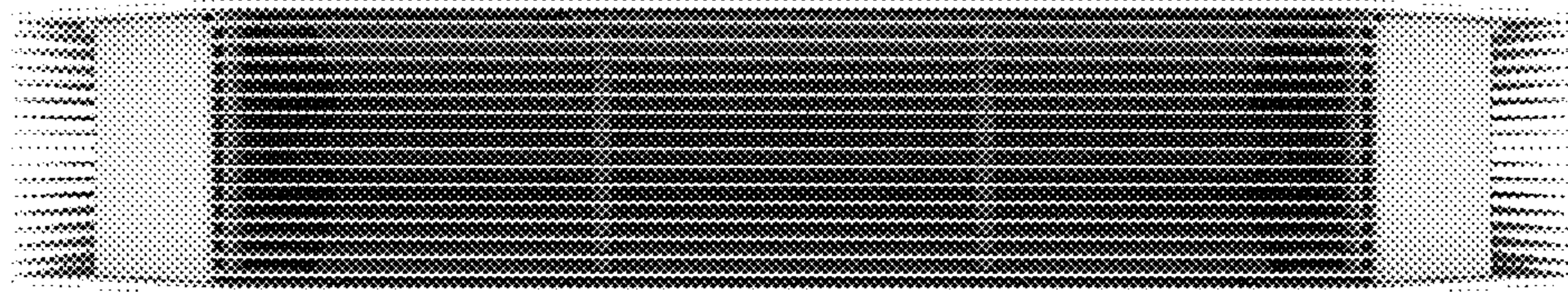

1.3

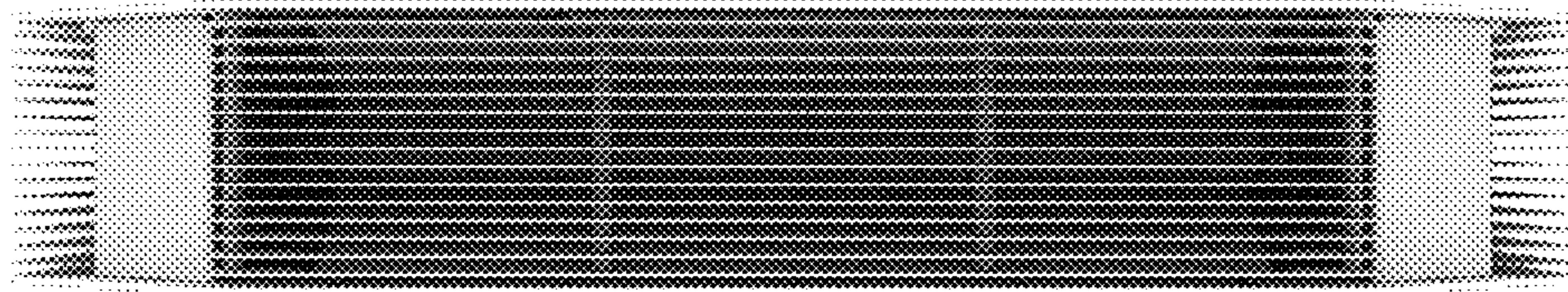

1.4

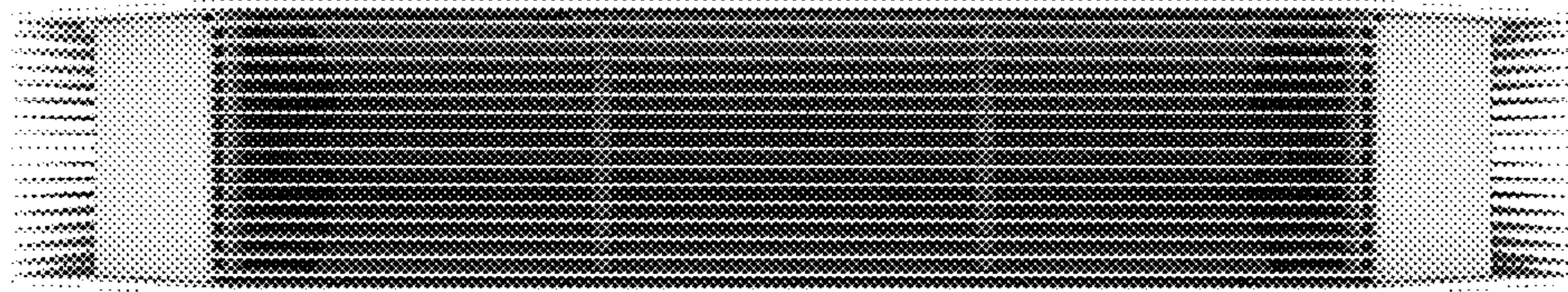

1.5

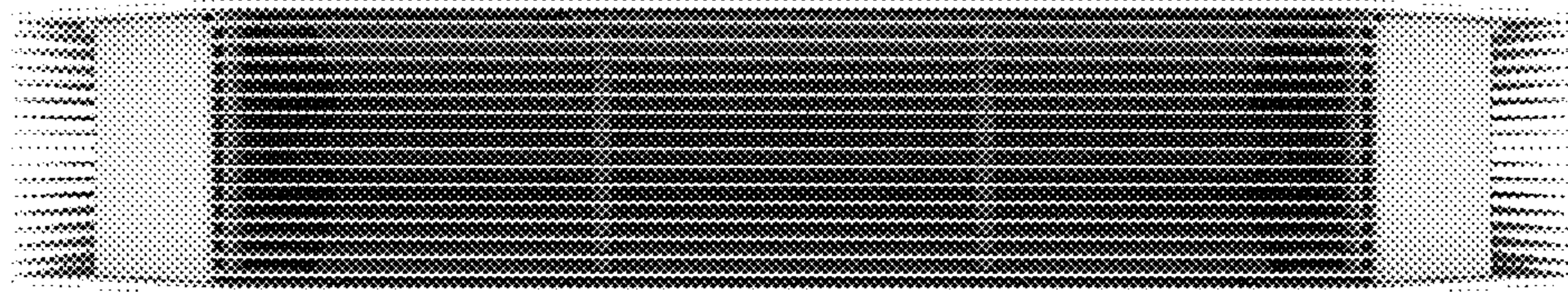

1.6

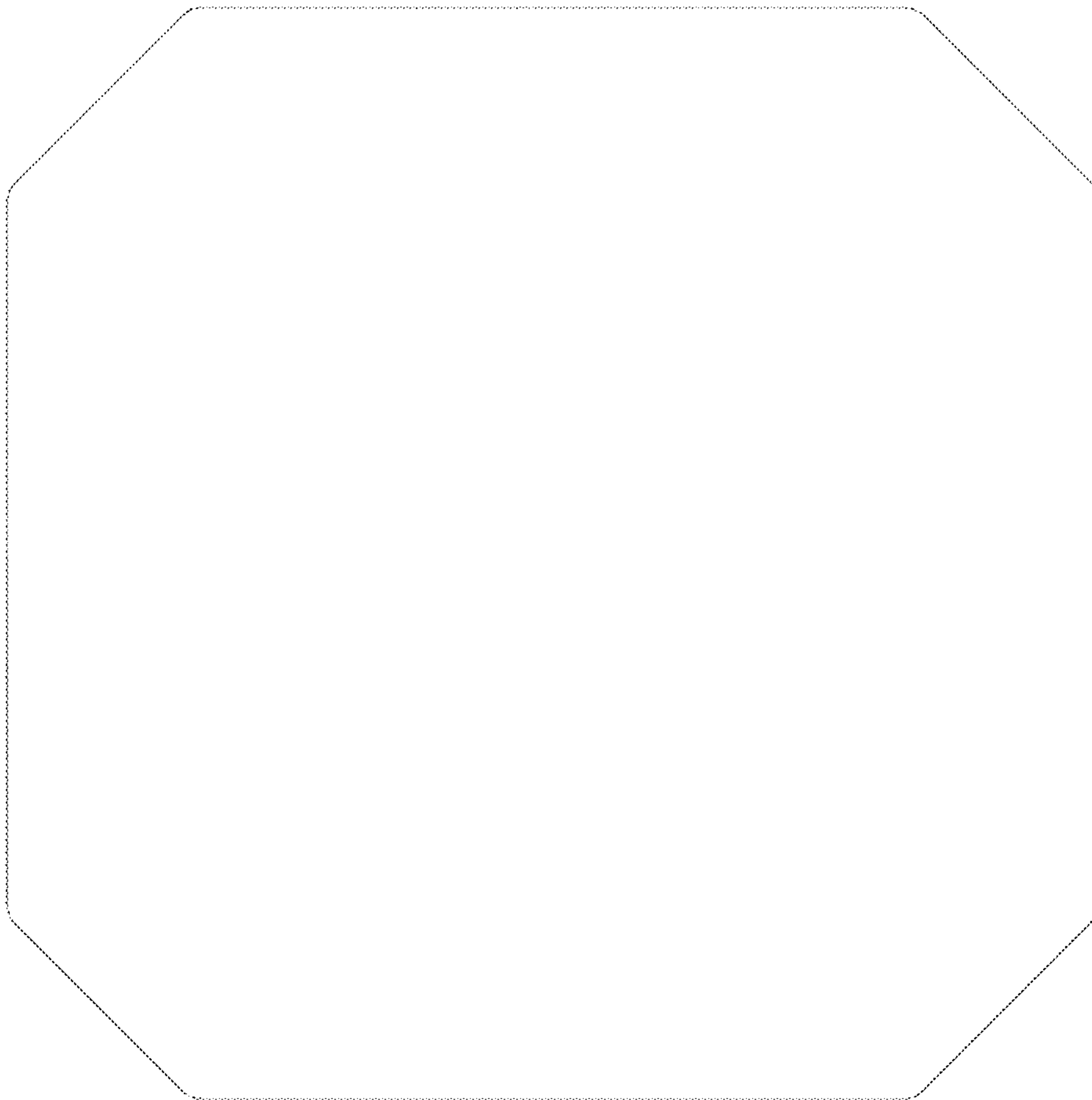

1.7

