



US00D947334S

(12) **United States Design Patent**  
**Wen**

(10) **Patent No.:** **US D947,334 S**  
(45) **Date of Patent:** **\*\* Mar. 29, 2022**

(54) **DEHUMIDIFIER**

(71) Applicant: **Ximei Wen**, Puning (CN)

(72) Inventor: **Ximei Wen**, Puning (CN)

(\*\*) Term: **15 Years**

(21) Appl. No.: **29/761,167**

(22) Filed: **Dec. 7, 2020**

(51) **LOC (13) Cl.** ..... **23-04**

(52) **U.S. Cl.**  
USPC ..... **D23/359**

(58) **Field of Classification Search**  
USPC ..... D23/355-366, 352, 369, 332, 333, 335,  
D23/336, 342, 351; 422/120, 122;  
55/356, 473, 504; 96/97; 261/DIG. 17,  
261/DIG. 65, DIG. 88, DIG. 31  
CPC .. A61L 9/16; A61L 9/22; B01D 47/00; B01D  
47/027; B01D 2221/02; B01D 2259/4508;  
B03C 3/155; B03C 3/368; F24F 3/16;  
F24F 13/20; F24F 13/28  
See application file for complete search history.

(56) **References Cited**

**U.S. PATENT DOCUMENTS**

D844,766 S \* 4/2019 Miao ..... D23/364  
D893,009 S \* 8/2020 Choi ..... D23/364

10,823,434 B2 \* 11/2020 Shin ..... F24F 1/02  
D918,365 S \* 5/2021 Li ..... D23/359  
D918,366 S \* 5/2021 Li ..... D23/359  
D918,367 S \* 5/2021 Li ..... D23/359  
D919,780 S \* 5/2021 Li ..... D23/359  
D921,864 S \* 6/2021 Luo ..... D23/356  
11,054,153 B2 \* 7/2021 Myeong ..... F24F 1/022

\* cited by examiner

*Primary Examiner* — David G Muller

(57) **CLAIM**

The ornamental design for a dehumidifier, as shown and described.

**DESCRIPTION**

FIG. 1 is a front, left and top perspective view of a dehumidifier showing my new design; FIG. 2 is a bottom perspective view thereof; FIG. 3 is a rear and top perspective view thereof; FIG. 4 is a front elevation view thereof; FIG. 5 is a rear elevation view thereof; FIG. 6 is a left side elevation view thereof; FIG. 7 is a right side elevation view thereof; FIG. 8 is a top plan view thereof; and, FIG. 9 is a bottom plan view thereof. The broken lines depict portions of the dehumidifier that form no part of the claimed design.

**1 Claim, 9 Drawing Sheets**

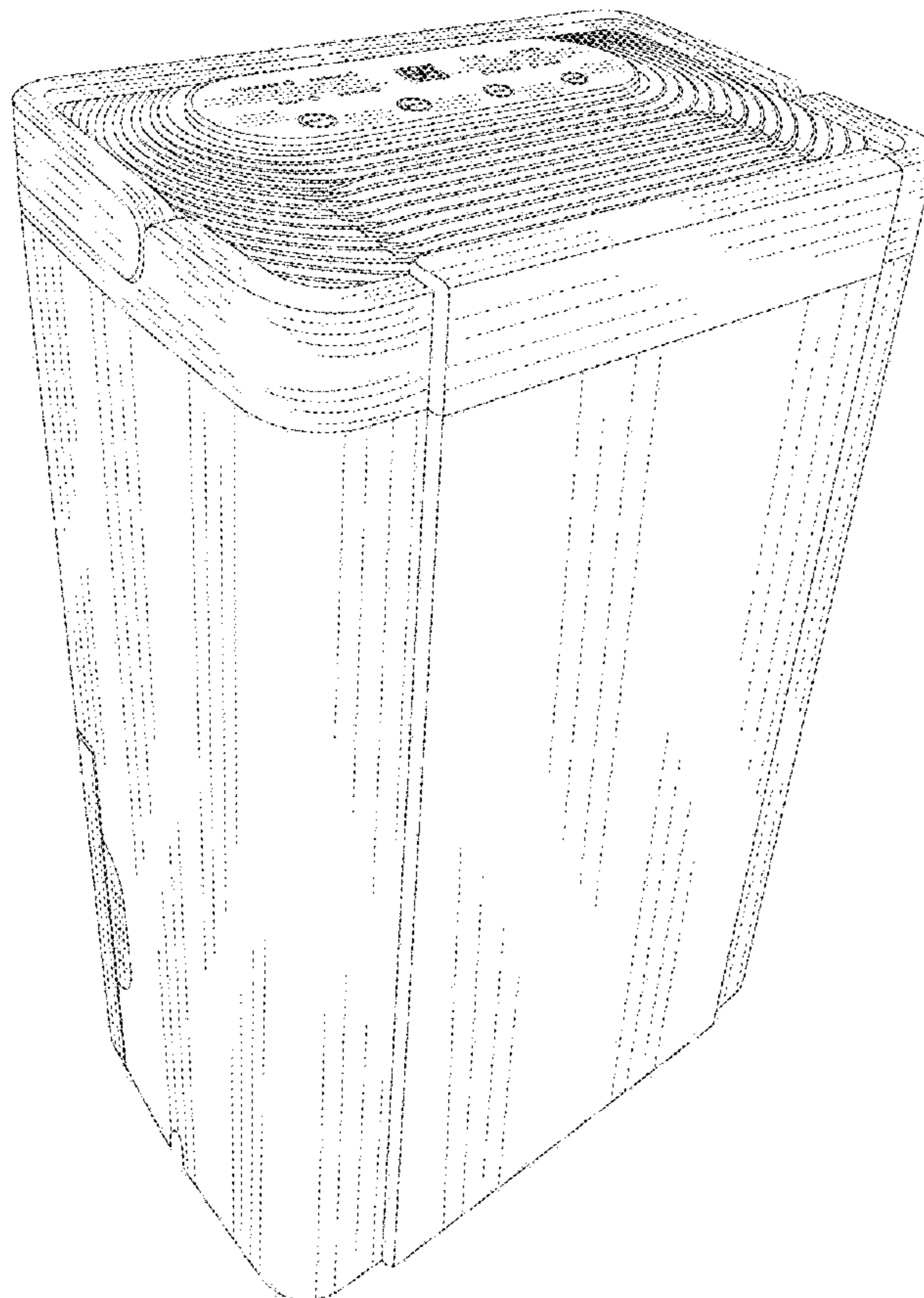

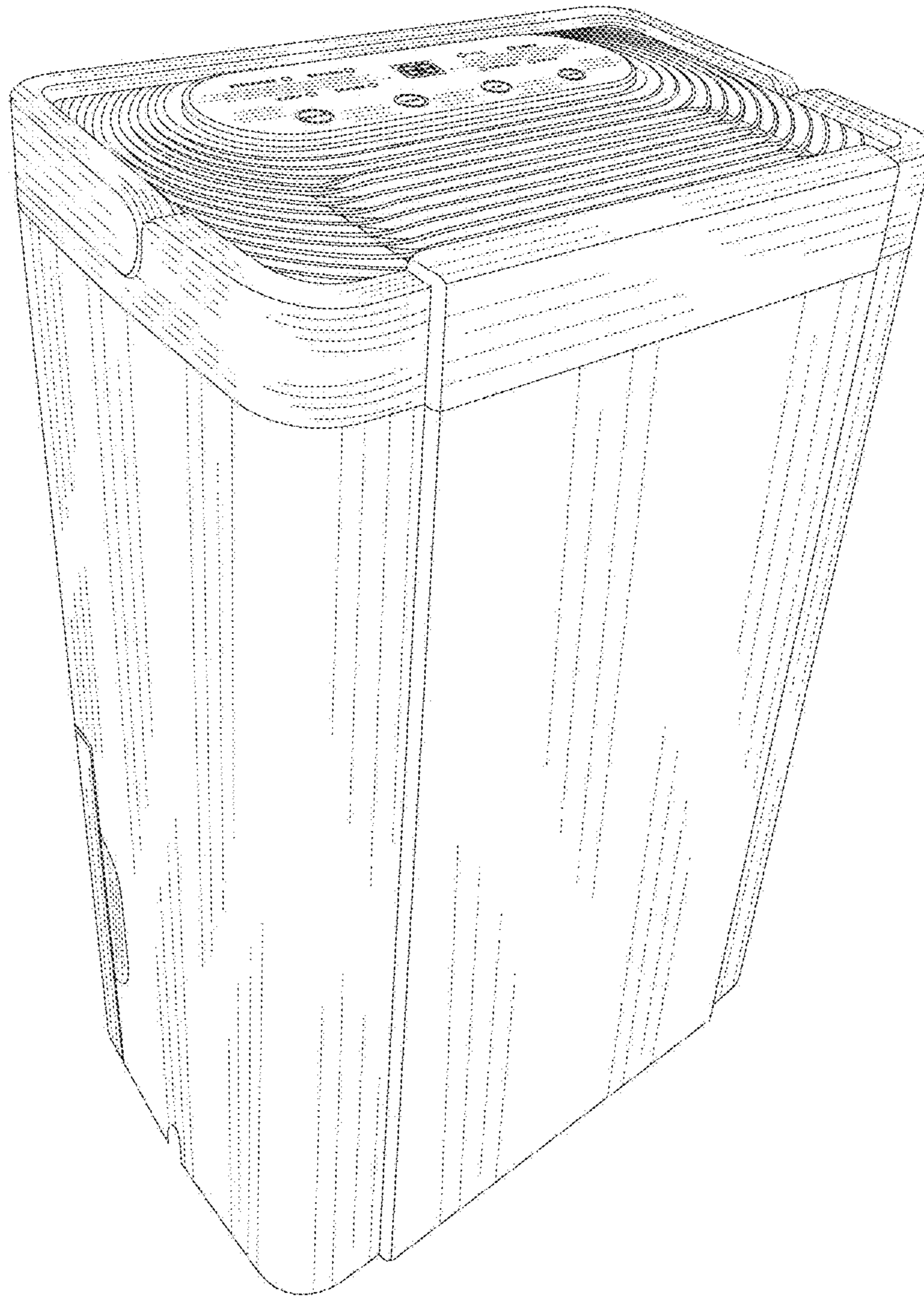

FIG.1

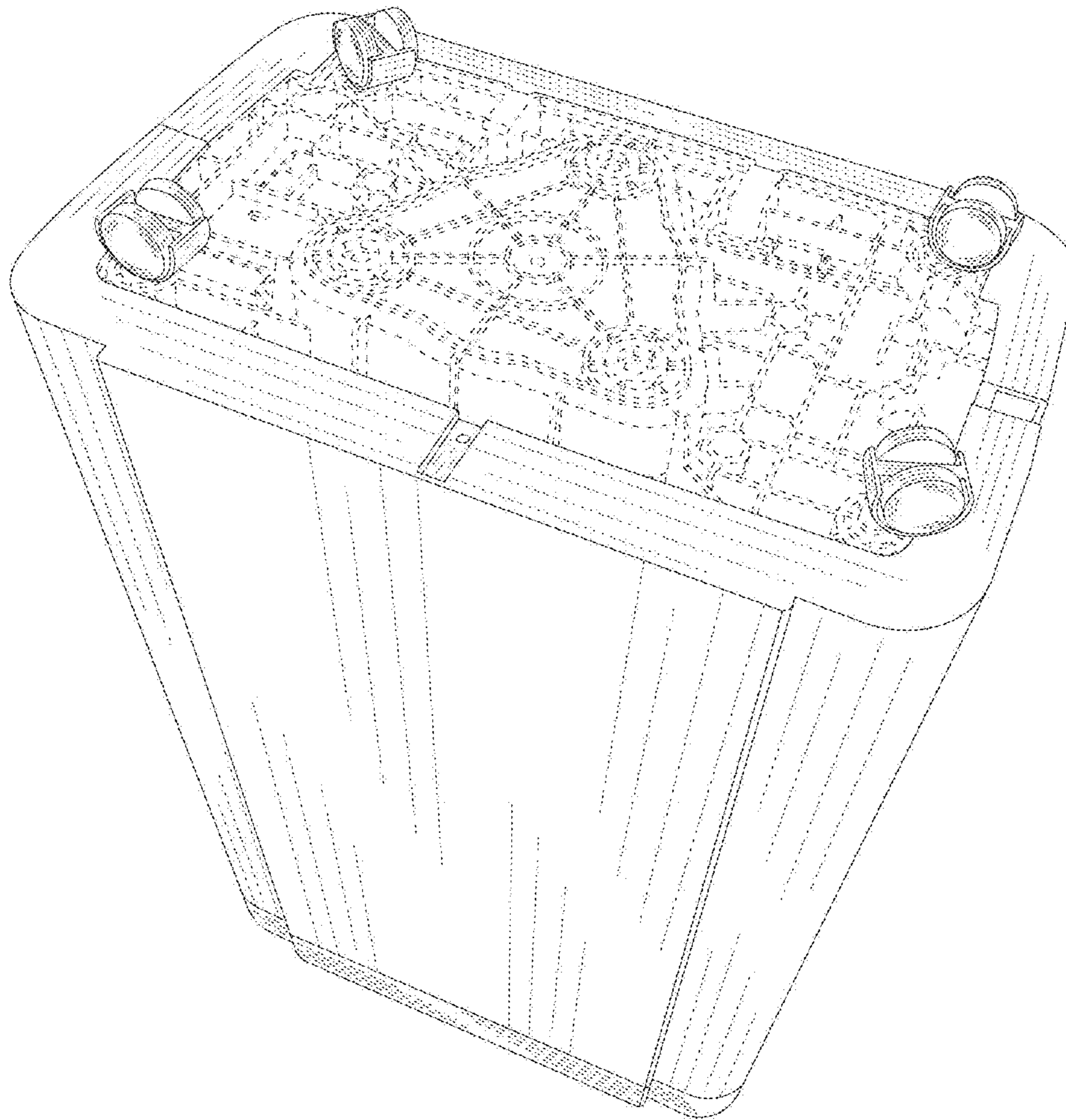

FIG.2

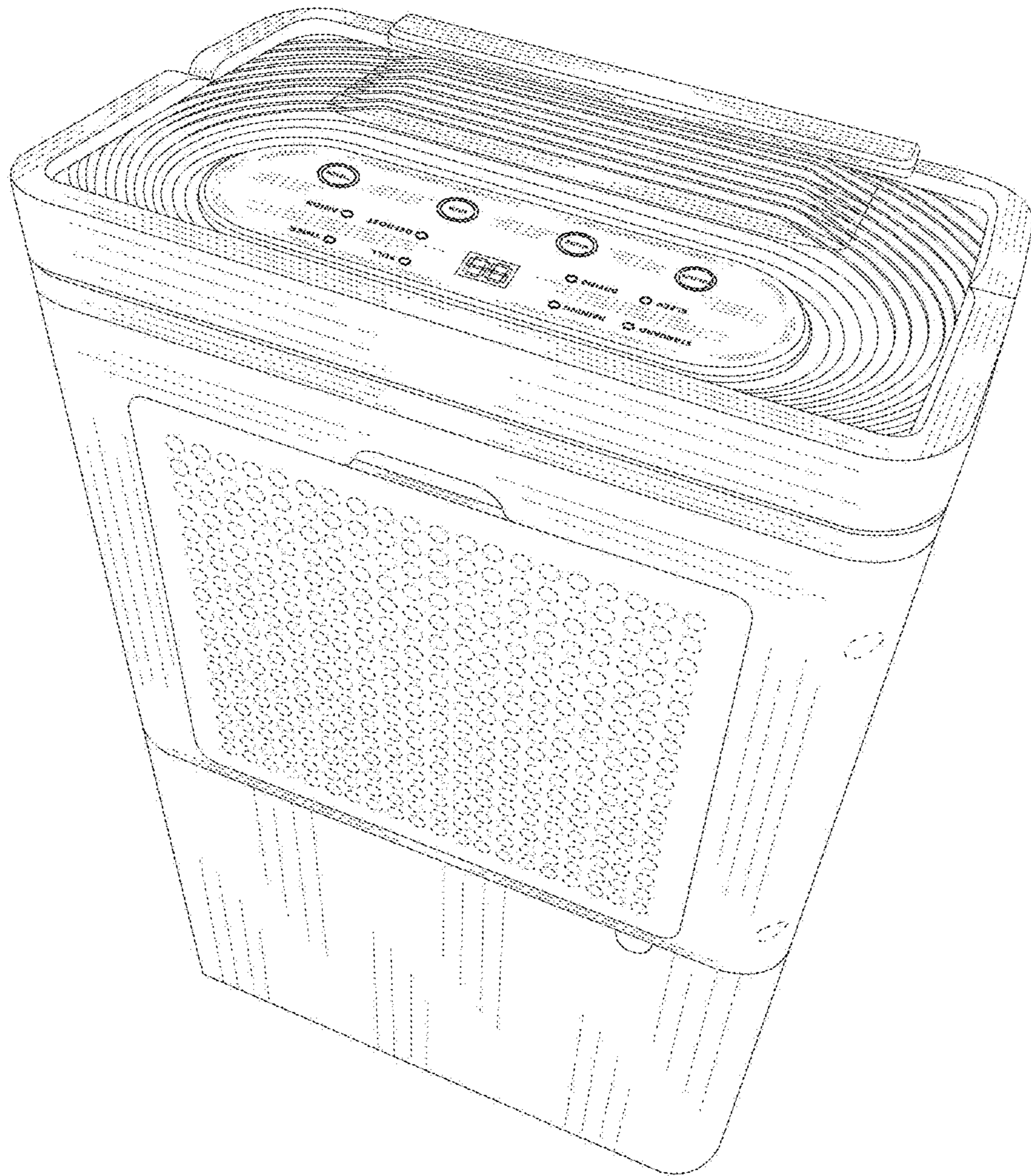

FIG.3

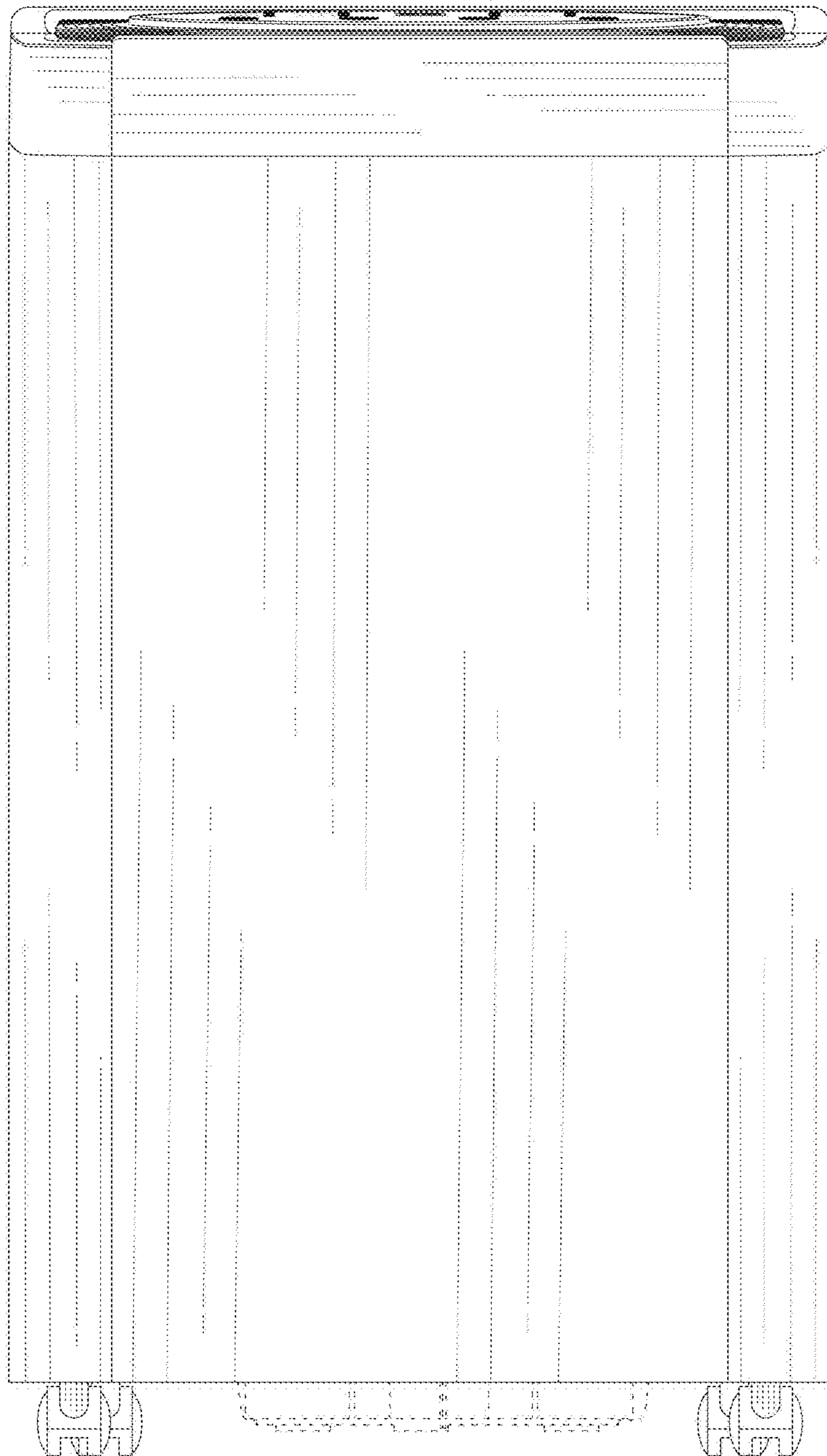

FIG.4

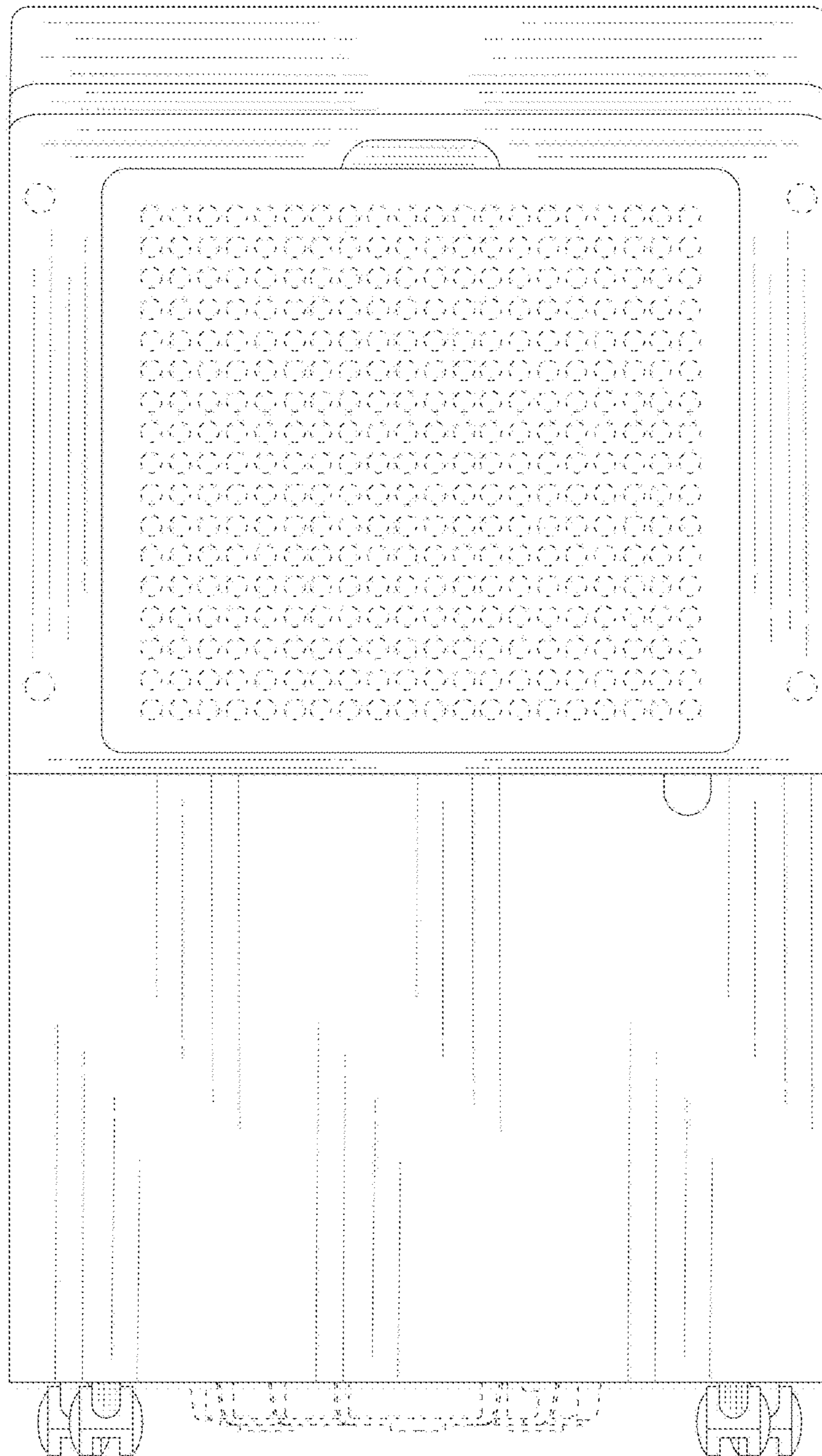

FIG. 5

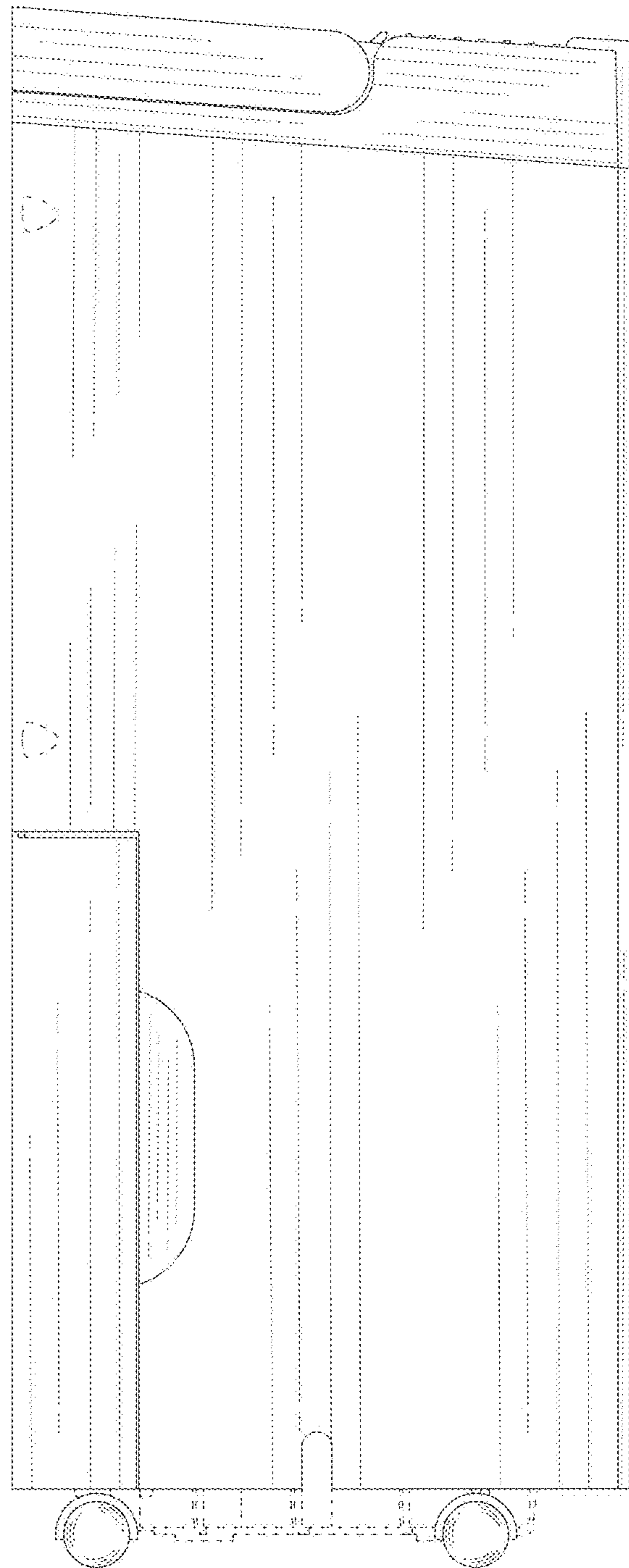

FIG.6

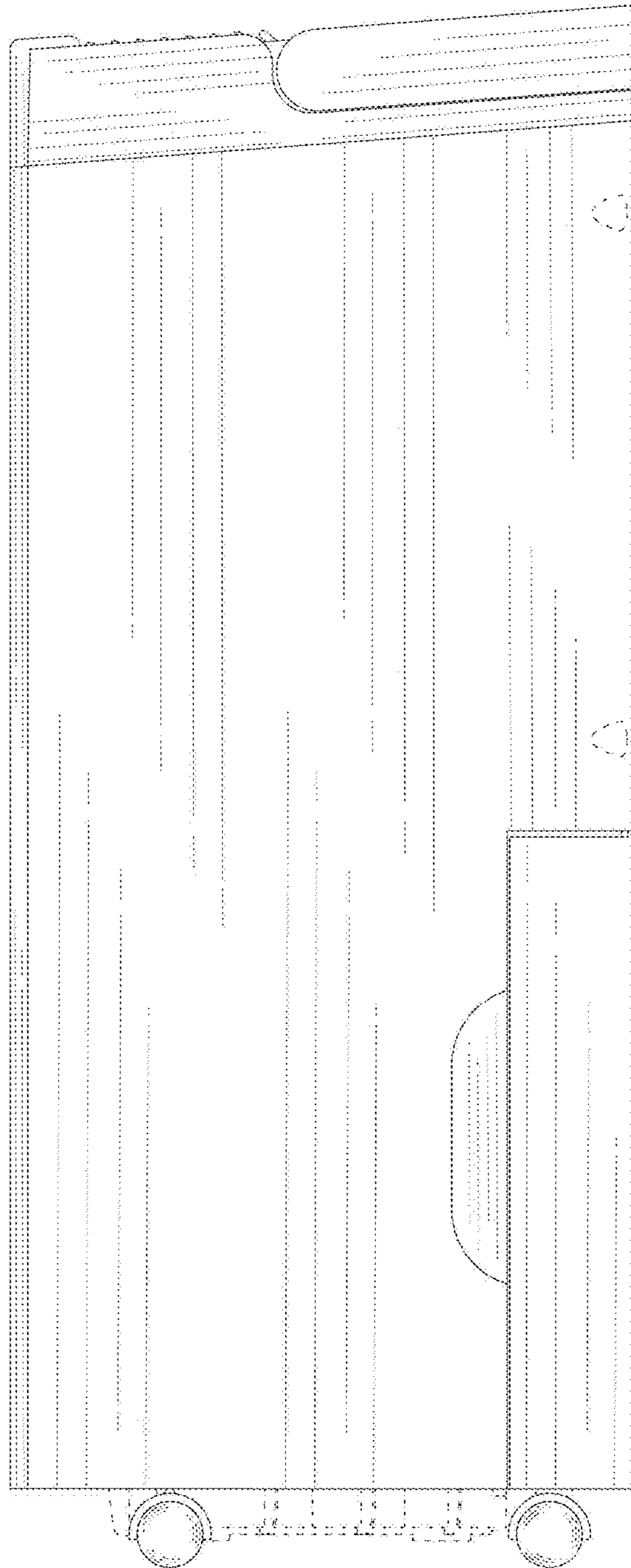

FIG. 7



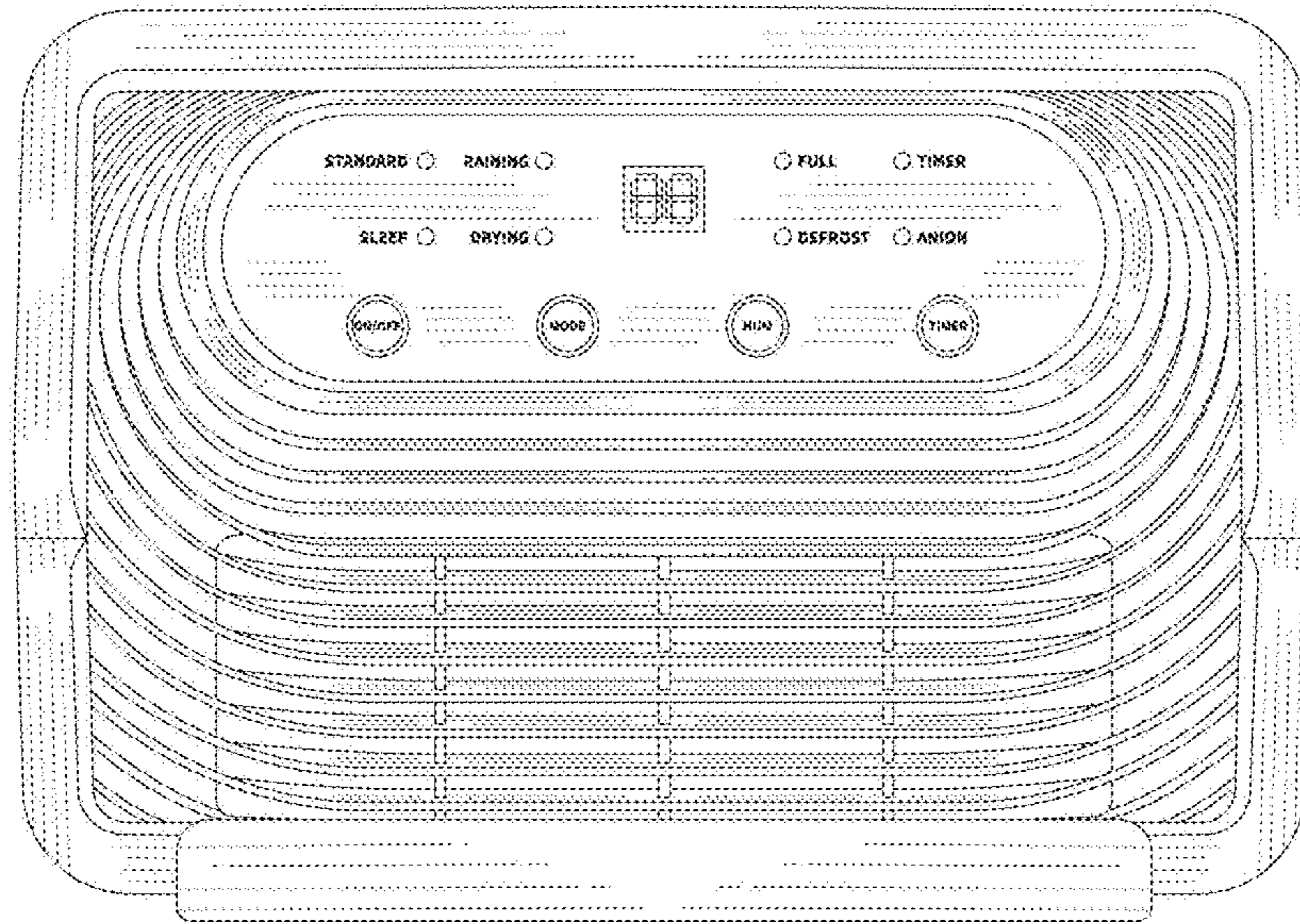

FIG. 8

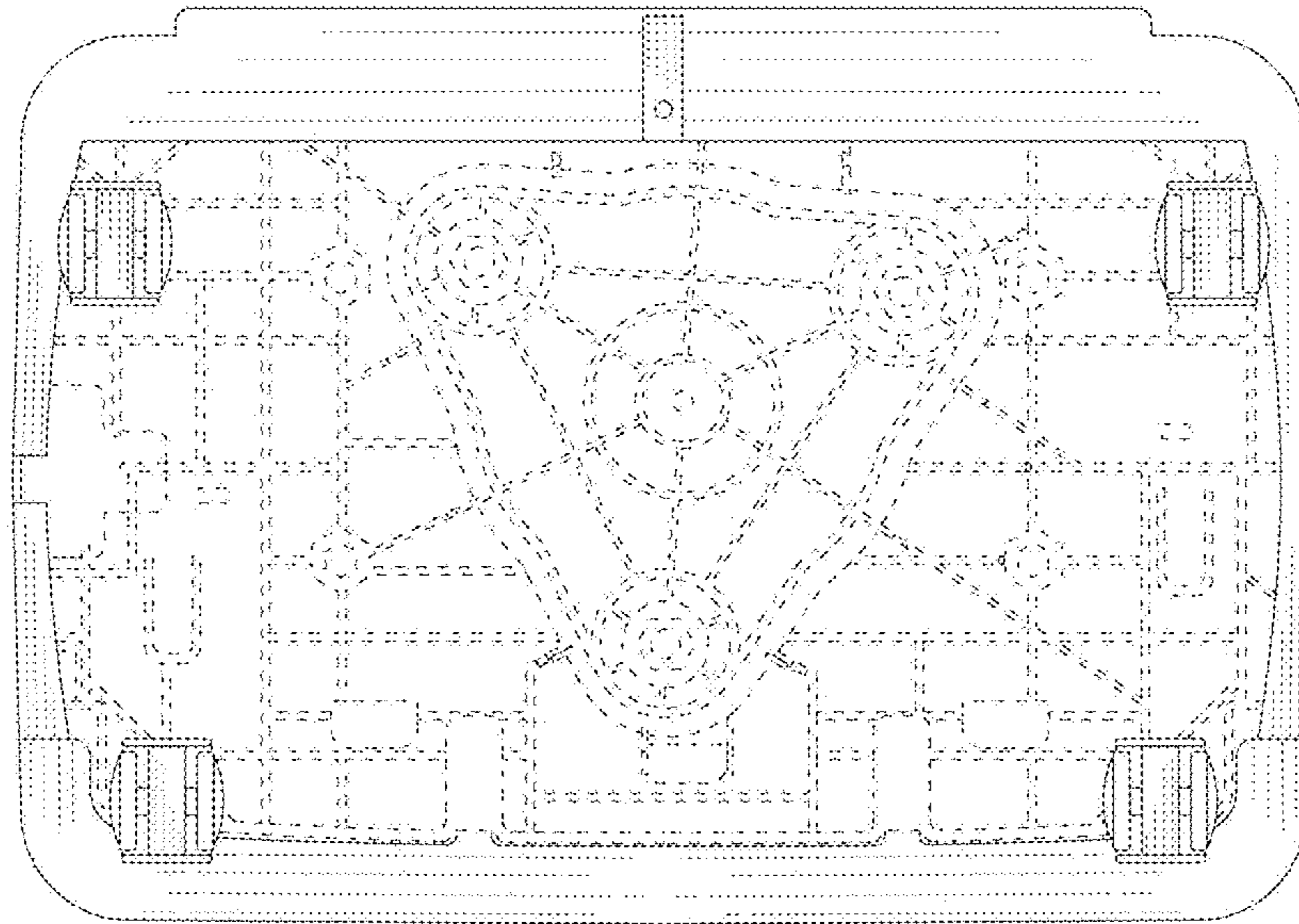

FIG. 9