



US00D947332S

(12) **United States Design Patent**  
**Zhang et al.**

(10) **Patent No.:** **US D947,332 S**  
(45) **Date of Patent:** **\*\* Mar. 29, 2022**

(54) **ELECTRIC HEATER**

(71) Applicant: **BEIJING XIAOMI MOBILE SOFTWARE CO., LTD.**, Beijing (CN)  
(72) Inventors: **Lei Zhang**, Beijing (CN); **Jinming Yu**, Beijing (CN); **Chang Jin**, Beijing (CN)  
(73) Assignee: **BEIJING XIAOMI MOBILE SOFTWARE CO., LTD.**, Beijing (CN)

(\*\*) Term: **15 Years**

(21) Appl. No.: **35/510,067**

(22) Filed: **Feb. 13, 2020**

(80) **Hague Agreement Data**

Int. Filing Date: **Feb. 13, 2020**  
Int. Reg. No.: **DM/207123**  
Int. Reg. Date: **Feb. 13, 2020**  
Int. Reg. Pub. Date: **Aug. 14, 2020**

(30) **Foreign Application Priority Data**

Aug. 15, 2019 (CN) ..... 201930444620.8

(51) **LOC (13) Cl.** ..... **23-03**

(52) **U.S. Cl.**  
USPC ..... **D23/330; D23/332; D23/335**

(58) **Field of Classification Search**  
USPC ..... D23/209, 233, 234, 235, 236, 237, 314, D23/318, 330, 332, 335, 341, 342, 355, D23/365, 370, 371, 375, 377, 379, 386, D23/393, 395, 411, 412, 413; D10/49, D10/50

(Continued)

(56) **References Cited**

**U.S. PATENT DOCUMENTS**

D53,525 S \* 7/1919 Potter ..... D23/330  
D68,002 S \* 8/1925 Kellogg ..... D23/330  
(Continued)

**OTHER PUBLICATIONS**

“Ahhh, that’s hot . . . A Smart Electrical Heater back by Xiaomi!” [online]. Martijn Wester. [Published on Nov. 6, 2019]. Retrieved from the Internet: <<https://www.youtube.com/watch?v=VsreYZ0Vwi8>>.\*

*Primary Examiner* — Mojtaba Tehrani  
(74) *Attorney, Agent, or Firm* — Amster, Rothstein & Ebenstein LLP

(57) **CLAIM**

The ornamental design for an electric heater, as shown and described.

**DESCRIPTION**

The patent or application file contains at least one drawing executed in color. Copies of this patent or patent application publication with color drawing(s) will be provided by the Office upon request and payment of the necessary fee.

1. and 3. Electric heater

- 1.1: Front
- 1.2 : Back
- 1.3 : Left
- 1.4 : Right
- 1.5: Top
- 1.6 : Bottom
- 1.7 : Perspective
- 3.1: Front
- 3.2 : Back
- 3.3 : Left
- 3.4 : Right
- 3.5: Top
- 3.6 : Bottom
- 3.7 : Perspective

The cyan background coloring in the reproduction views discloses the unclaimed environment only and forms no part of the claimed design.

**1 Claim, 14 Drawing Sheets**  
**(14 of 14 Drawing Sheet(s) Filed in Color)**

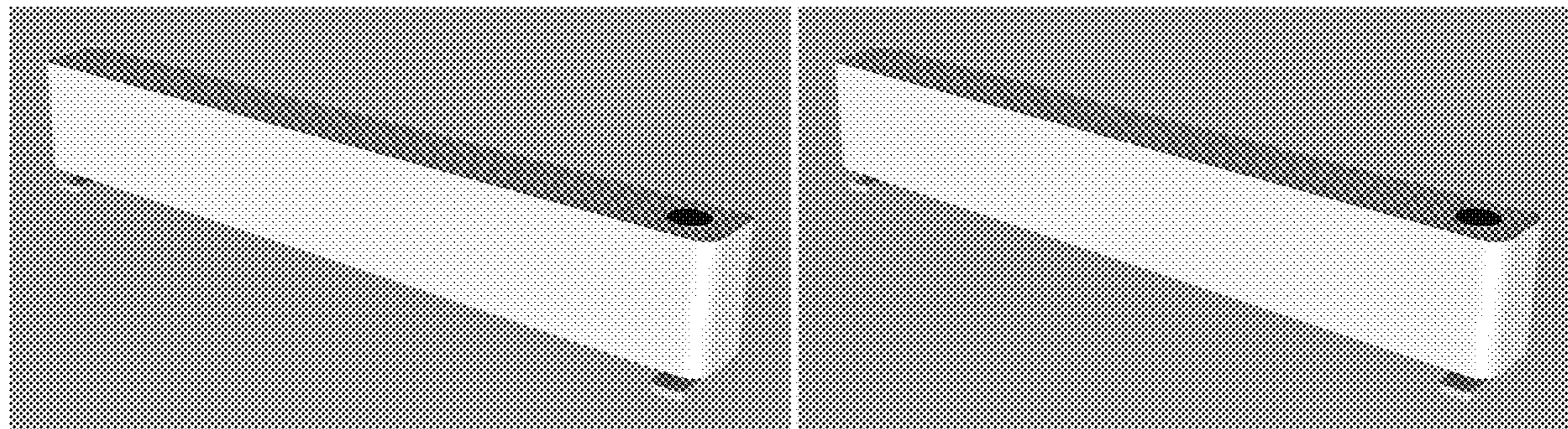

(58) **Field of Classification Search**

CPC .. G05D 23/13; G05D 23/136; G05D 23/1353;  
G05D 23/138; G05D 23/1386; F16K  
31/0693

See application file for complete search history.

(56) **References Cited**

U.S. PATENT DOCUMENTS

D96,488 S *	8/1935	Loewy .....	D23/330
D99,510 S *	5/1936	Kahn .....	D23/342
D281,526 S *	11/1985	Cenefels .....	D23/335
D348,725 S *	7/1994	Wortham .....	D23/332
D401,315 S *	11/1998	Boyle .....	D23/335
D464,718 S *	10/2002	Wilson .....	D23/341
D532,881 S *	11/2006	Ching .....	D23/335
D546,429 S *	7/2007	Ching .....	D23/342
D609,795 S *	2/2010	Yeung .....	D23/332
D678,491 S *	3/2013	Dong .....	D23/342
D678,492 S *	3/2013	Dong .....	D23/342
D802,107 S *	11/2017	Schumann .....	D23/330
D870,869 S *	12/2019	Bryn-Haugland .....	D23/332
D874,624 S *	2/2020	Liu .....	D23/335
D912,789 S *	3/2021	Chen .....	F24H 3/002 D23/342
D918,361 S *	5/2021	Bryn-Haugland .....	D23/342
D923,161 S *	6/2021	Lei .....	D23/330
D925,711 S *	7/2021	Deng .....	D23/334
D926,300 S *	7/2021	He .....	D23/335

\* cited by examiner

1.1

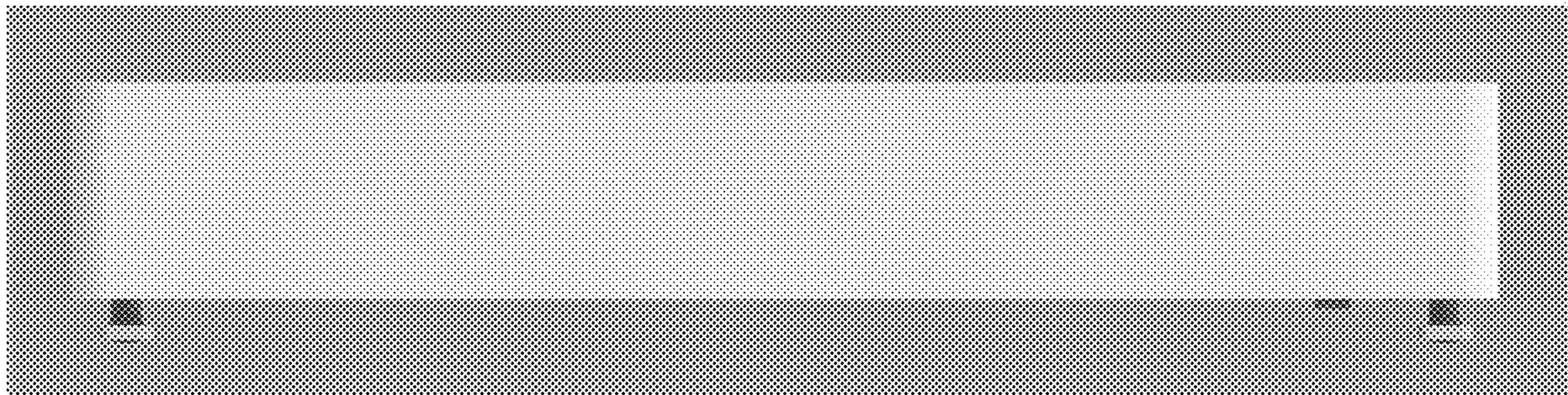

1.2

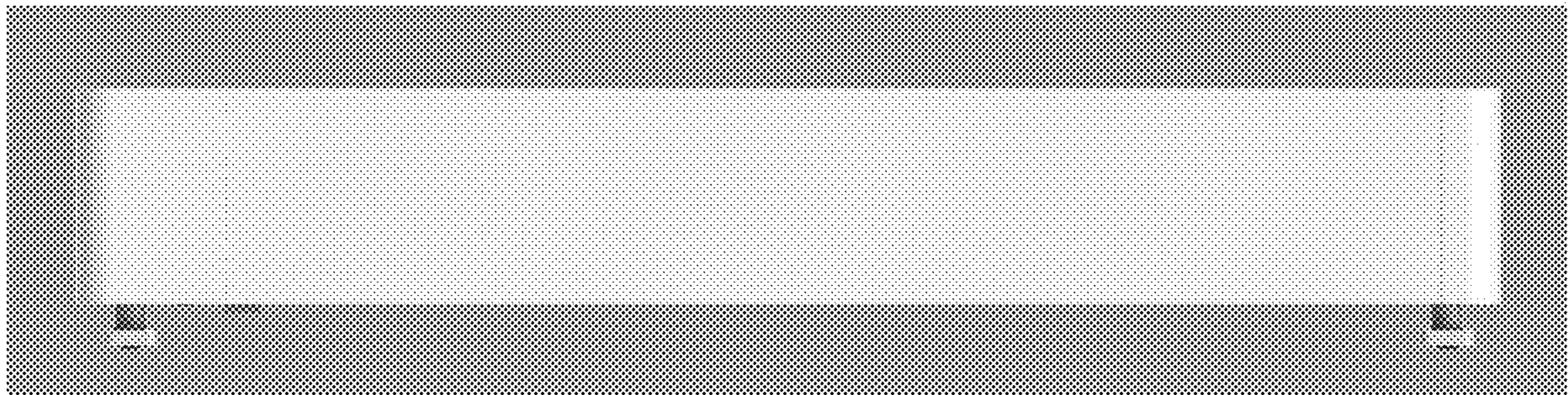

1.3

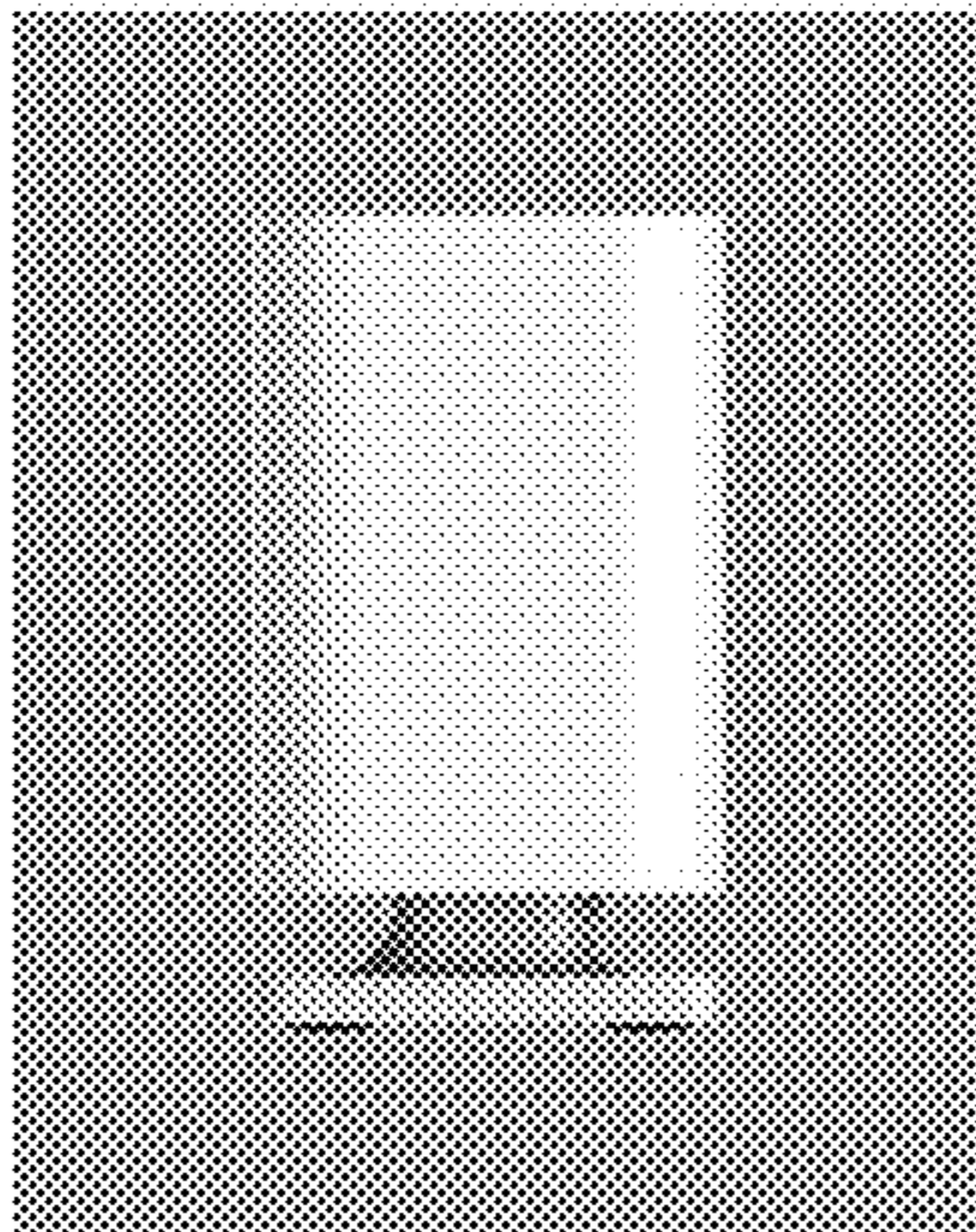

1.4

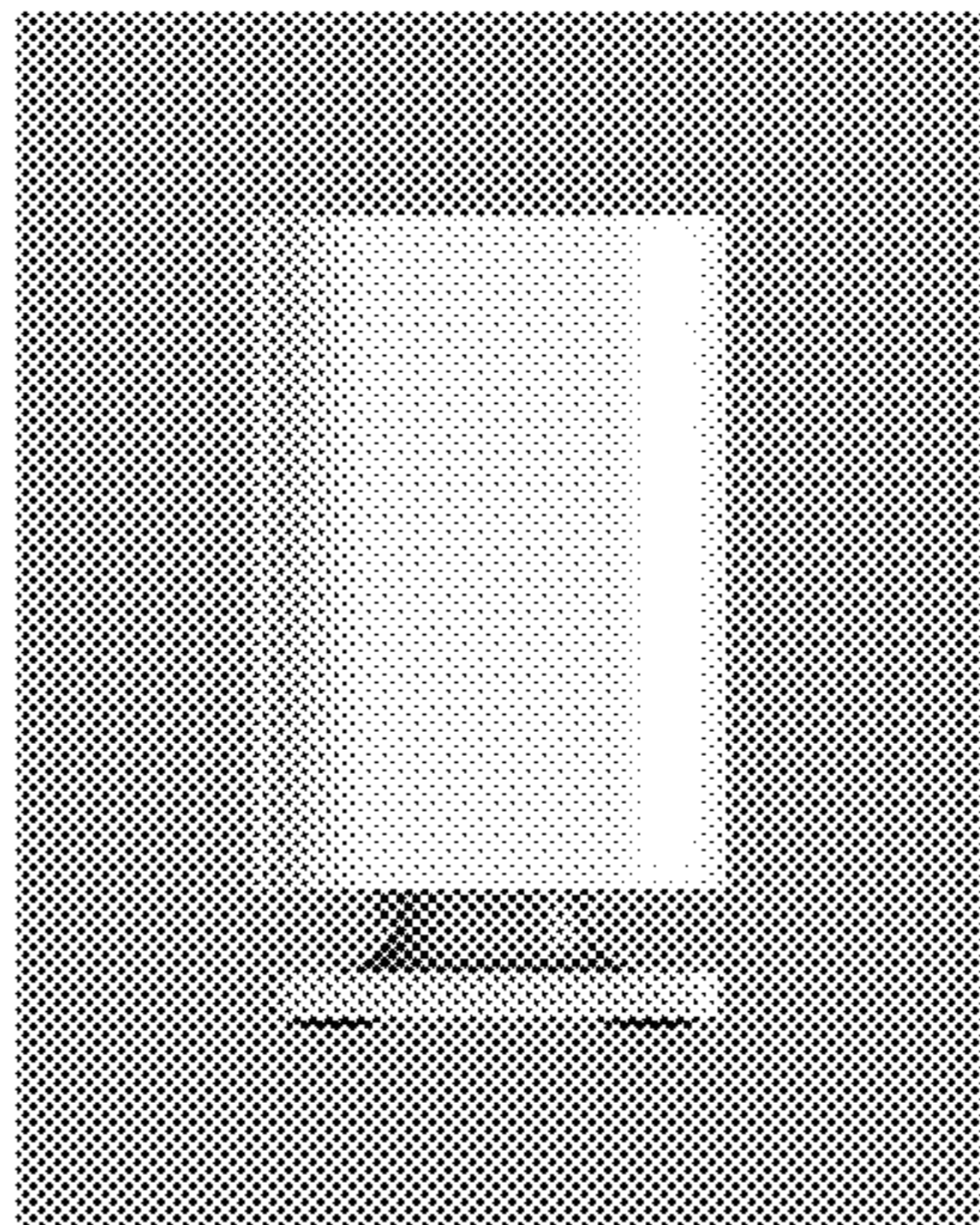

1.5

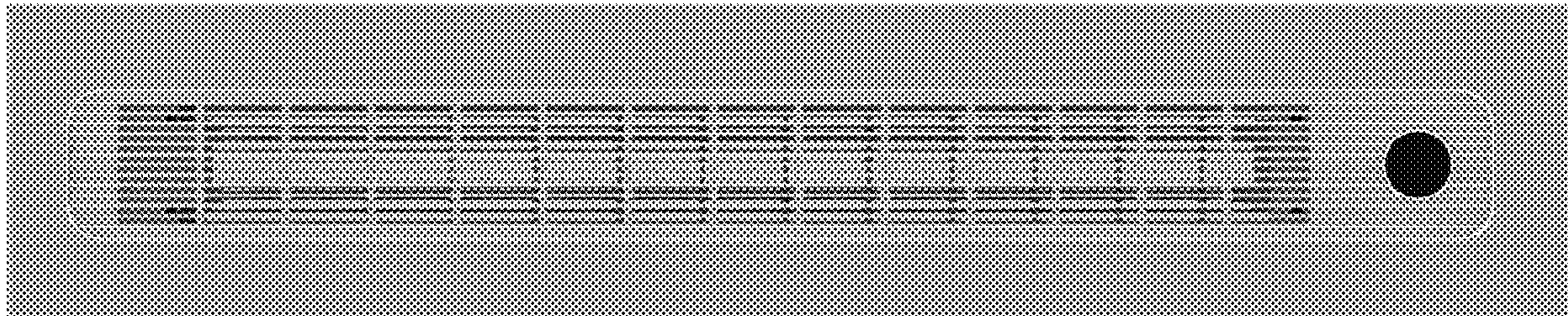

1.6

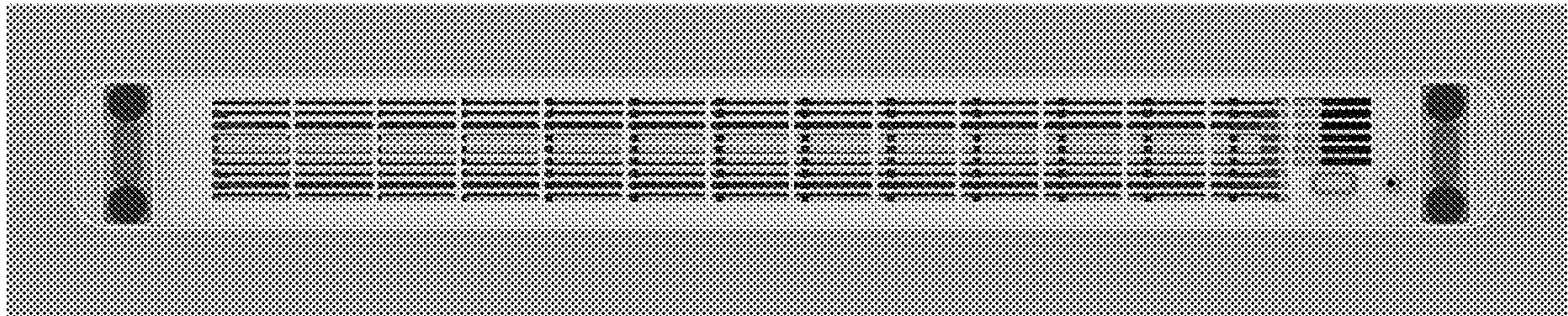



1.7

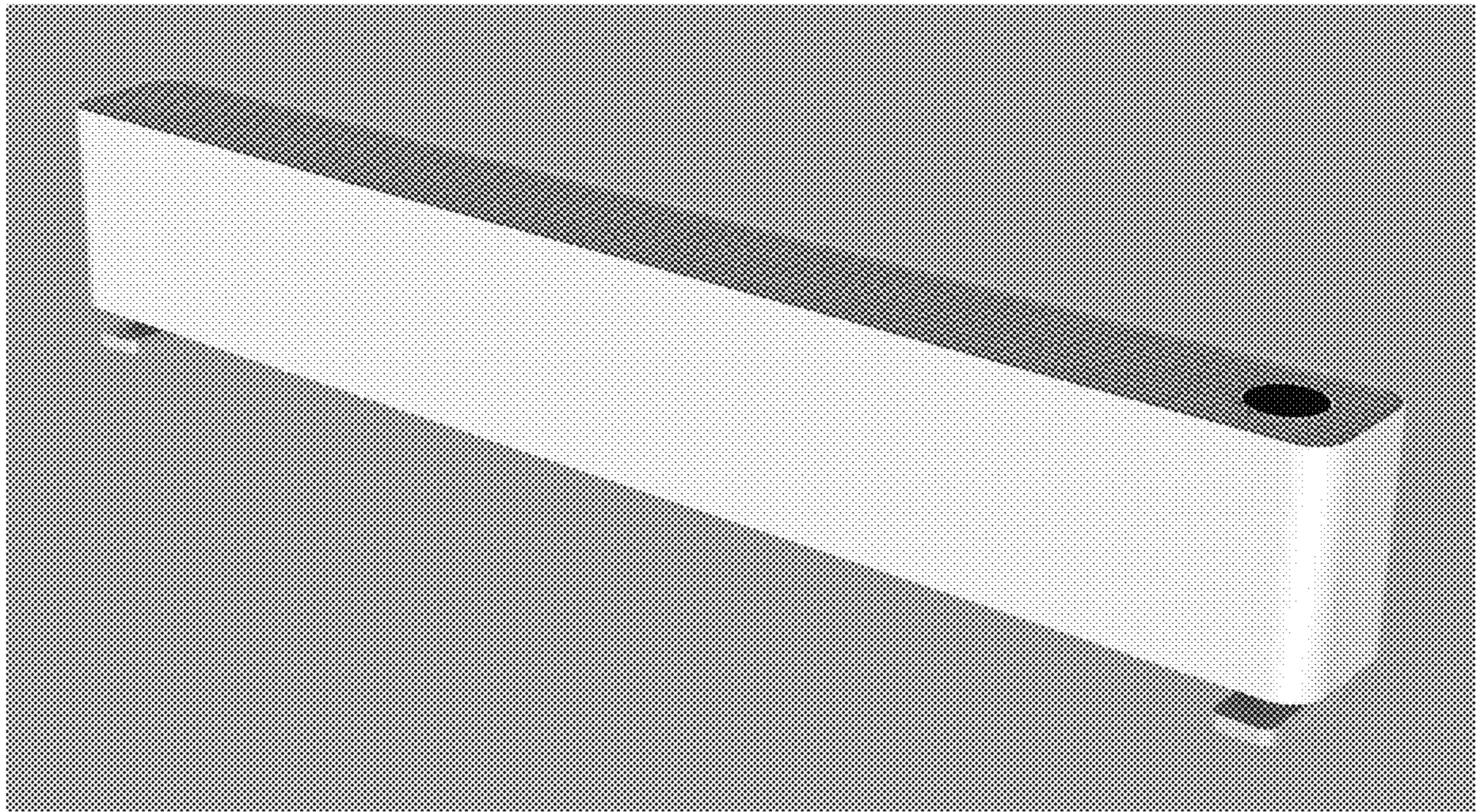

3.1

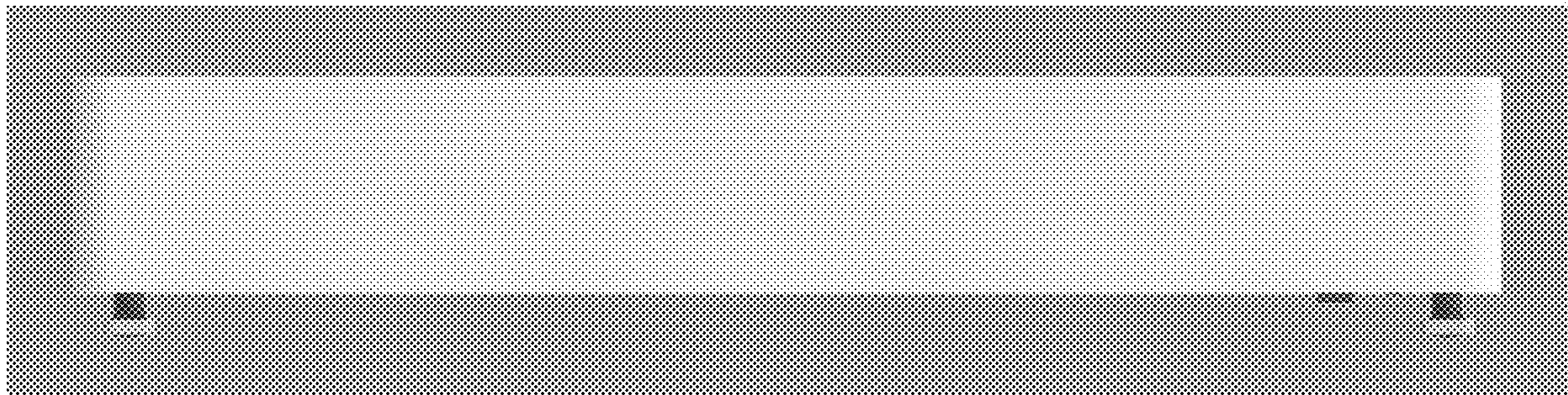

3.2

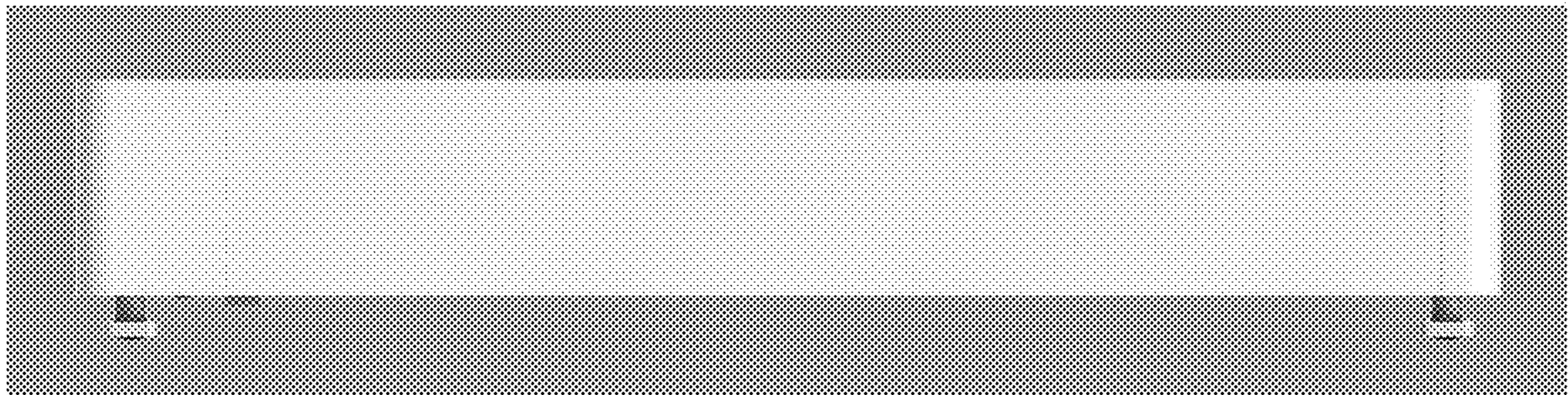

3.3

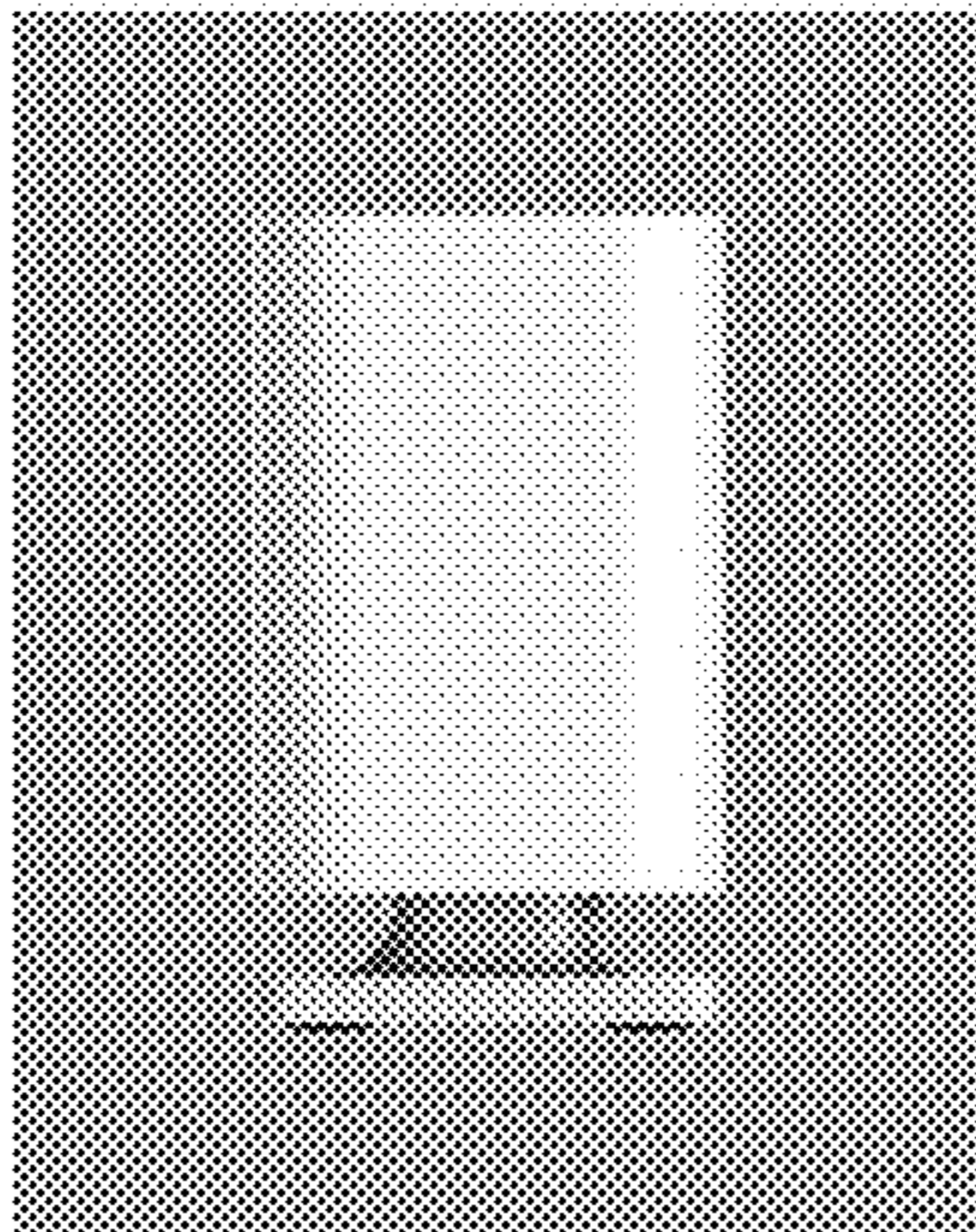

3.4

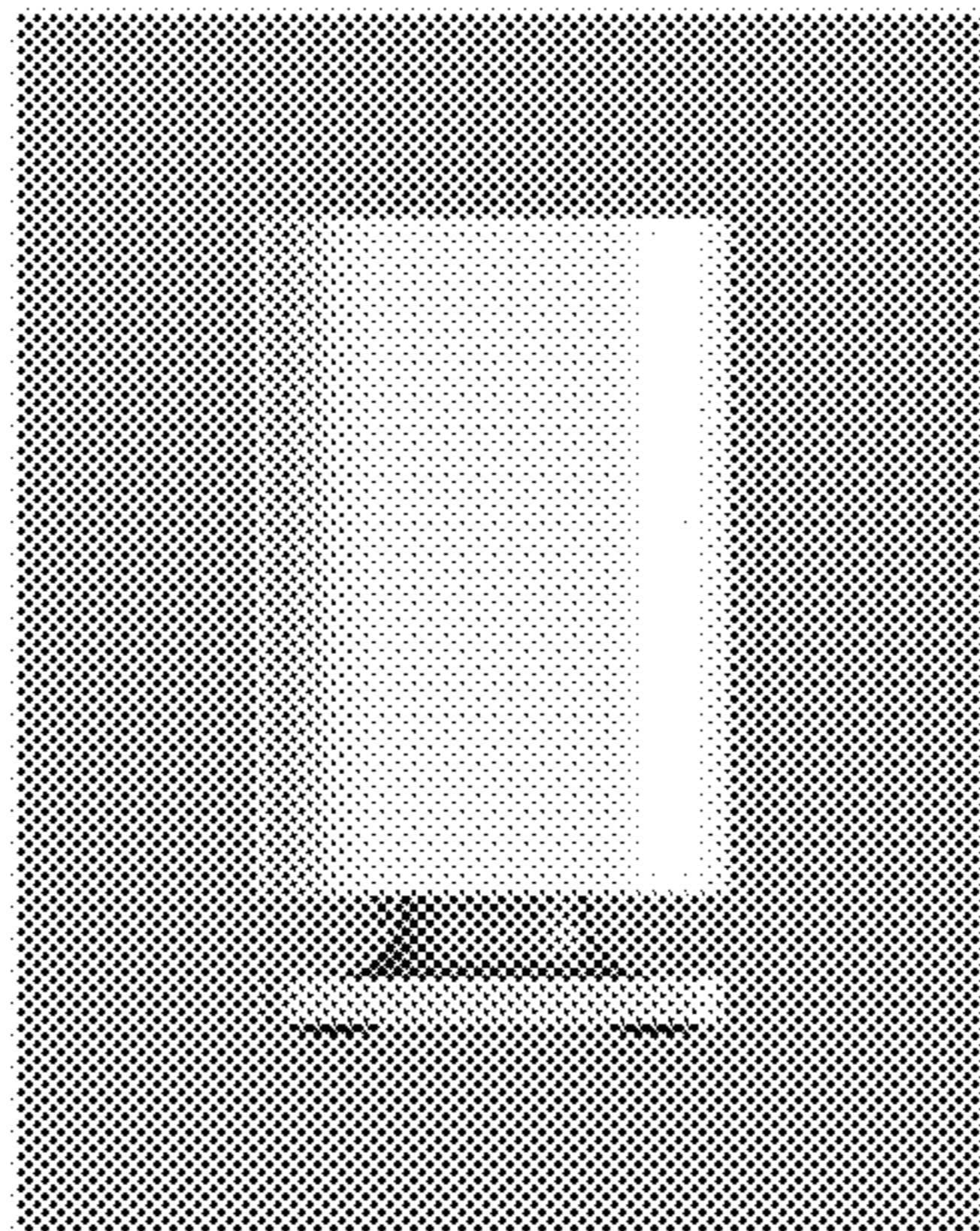

3.5

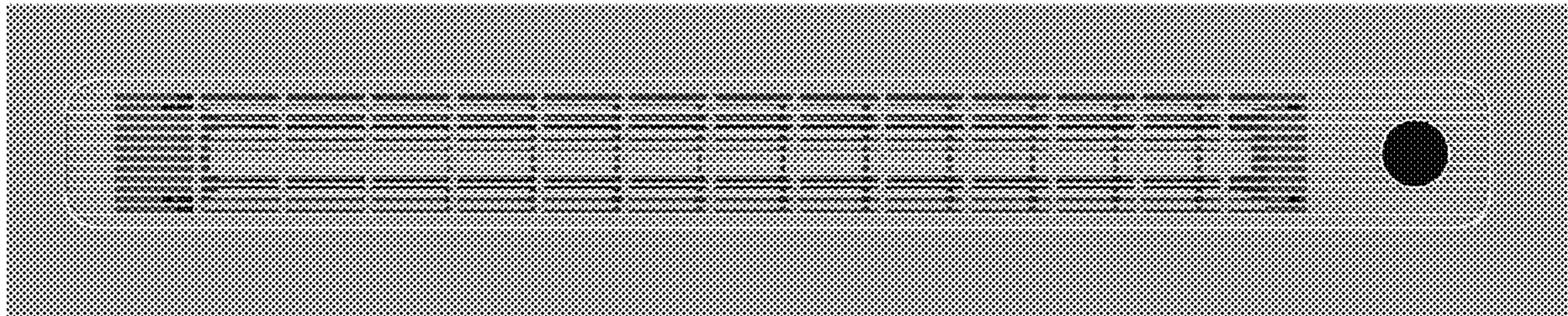

3.6

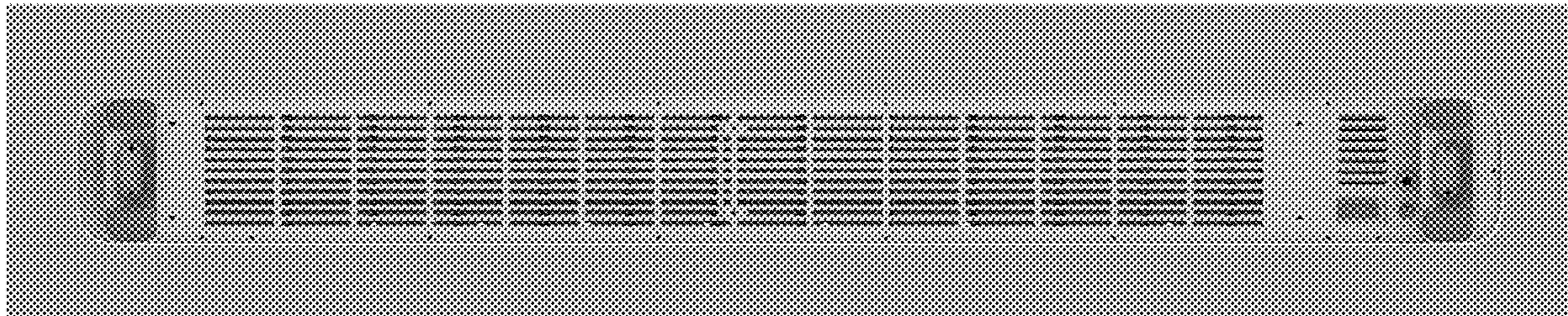

3.7

