



US00D947314S

(12) **United States Design Patent** (10) **Patent No.:** **US D947,314 S**
Yamao (45) **Date of Patent:** **** Mar. 29, 2022**

(54) **FISH LURE**

(71) Applicant: **Kalbas & Co. Limited**, Hong Kong (HK)
(72) Inventor: **Yuichi Yamao**, Hong Kong (HK)
(**) Term: **15 Years**

(21) Appl. No.: **29/745,747**

(22) Filed: **Aug. 7, 2020**

(51) **LOC (13) Cl.** **22-05**

(52) **U.S. Cl.**
USPC **D22/132**

(58) **Field of Classification Search**
USPC D22/126-133; D21/597, 607-608
CPC A01K 85/00; A01K 85/02; A01K 85/14;
A01K 85/16; A01K 85/18; A01K 85/005;
A01K 83/02

See application file for complete search history.

(56) **References Cited**

U.S. PATENT DOCUMENTS

D270,177 S *	8/1983	Storm	D22/126
4,891,900 A *	1/1990	Snyder	A01K 85/14 43/42.5
D321,739 S *	11/1991	Thompson	D22/128
D334,612 S *	4/1993	Snyder	D22/126
D435,627 S *	12/2000	Snyder	D22/126
D511,367 S *	11/2005	Bowling	D22/126
D593,636 S *	6/2009	Hymas	D22/126
D796,625 S *	9/2017	Butler	D22/126
D800,866 S *	10/2017	Lestander	D22/126

OTHER PUBLICATIONS

Bill Lewis Stutter Step 5.0—1oz . . . https://www.flyshack.com/DisplayItem.aspx?ItemID=117746&src=froogle&clid=EAlalQobChMI6JL_x9iW9QIVEIzICh1IIQIREAQYBCABEgJO7_D_BwE (Date unknown).
Duck-Bill Drop . . . <https://shop.clamoutdoors.com/duck-bill-drop.html> (Year: 2019).*

* cited by examiner

Primary Examiner — Catherine R Oliver-Garcia
(74) *Attorney, Agent, or Firm* — Novoclaims Patent Services LLC; Mei Lin Wong

(57) **CLAIM**

The ornamental design for a fish lure, as shown and described.

DESCRIPTION

FIG. 1 is a front perspective view of a fish lure, showing my new design;
FIG. 2 is a front view thereof;
FIG. 3 is a rear view thereof;
FIG. 4 is a right side view thereof;
FIG. 5 is a left side view thereof;
FIG. 6 is a top view thereof;
FIG. 7 is a bottom view thereof;
FIG. 8 is a rear perspective view thereof; and,
FIG. 9 is a bottom perspective view thereof.

1 Claim, 9 Drawing Sheets

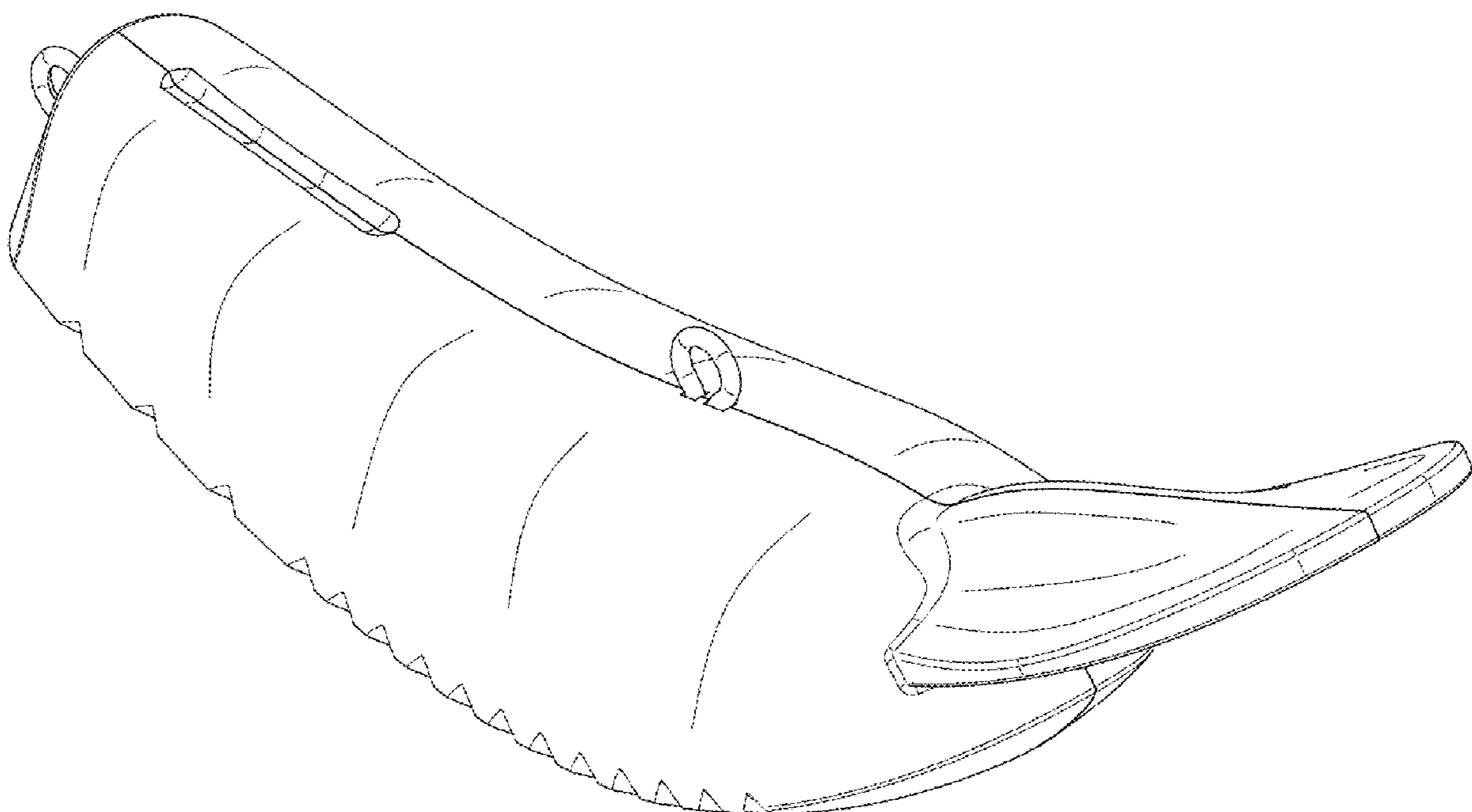

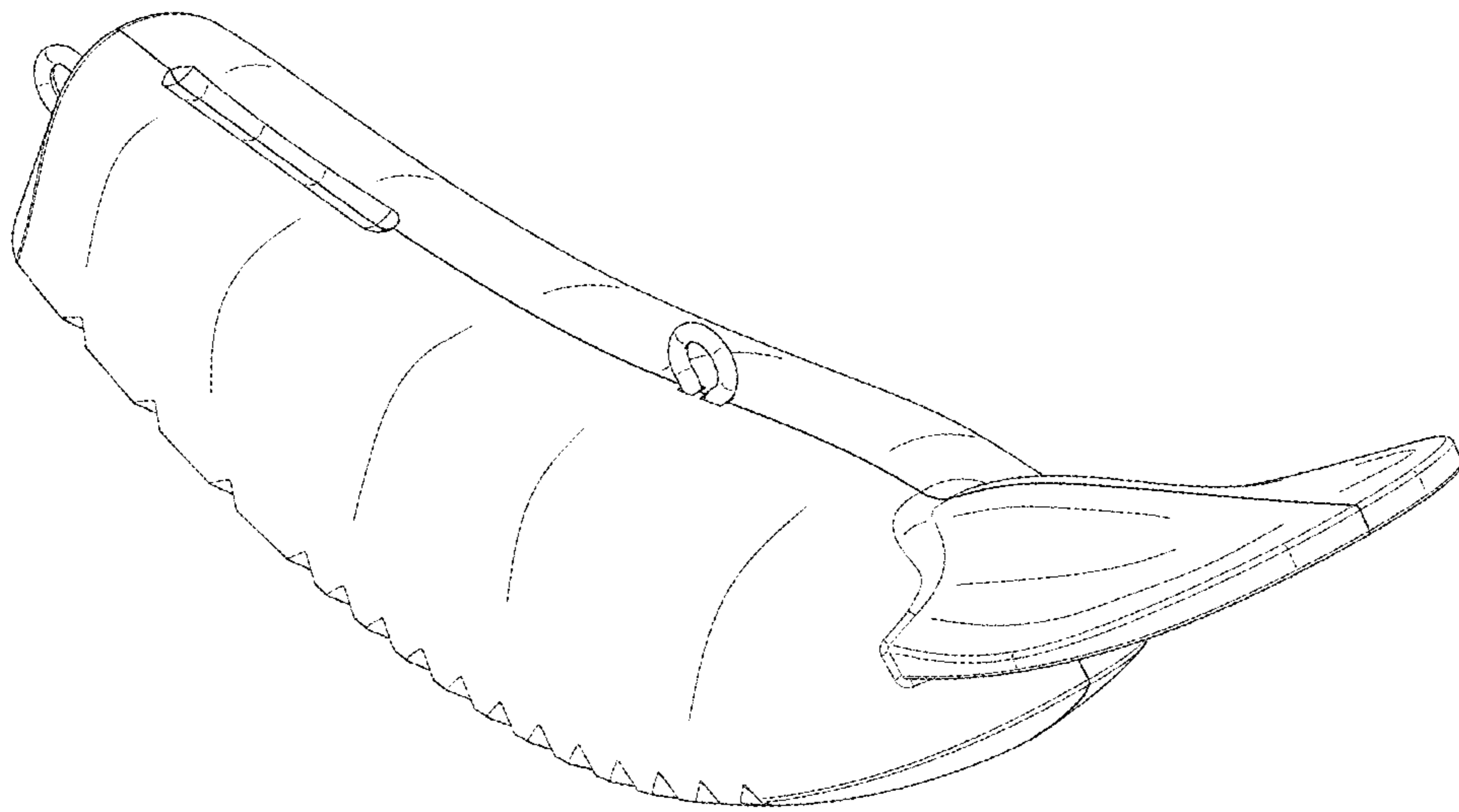

FIG. 1

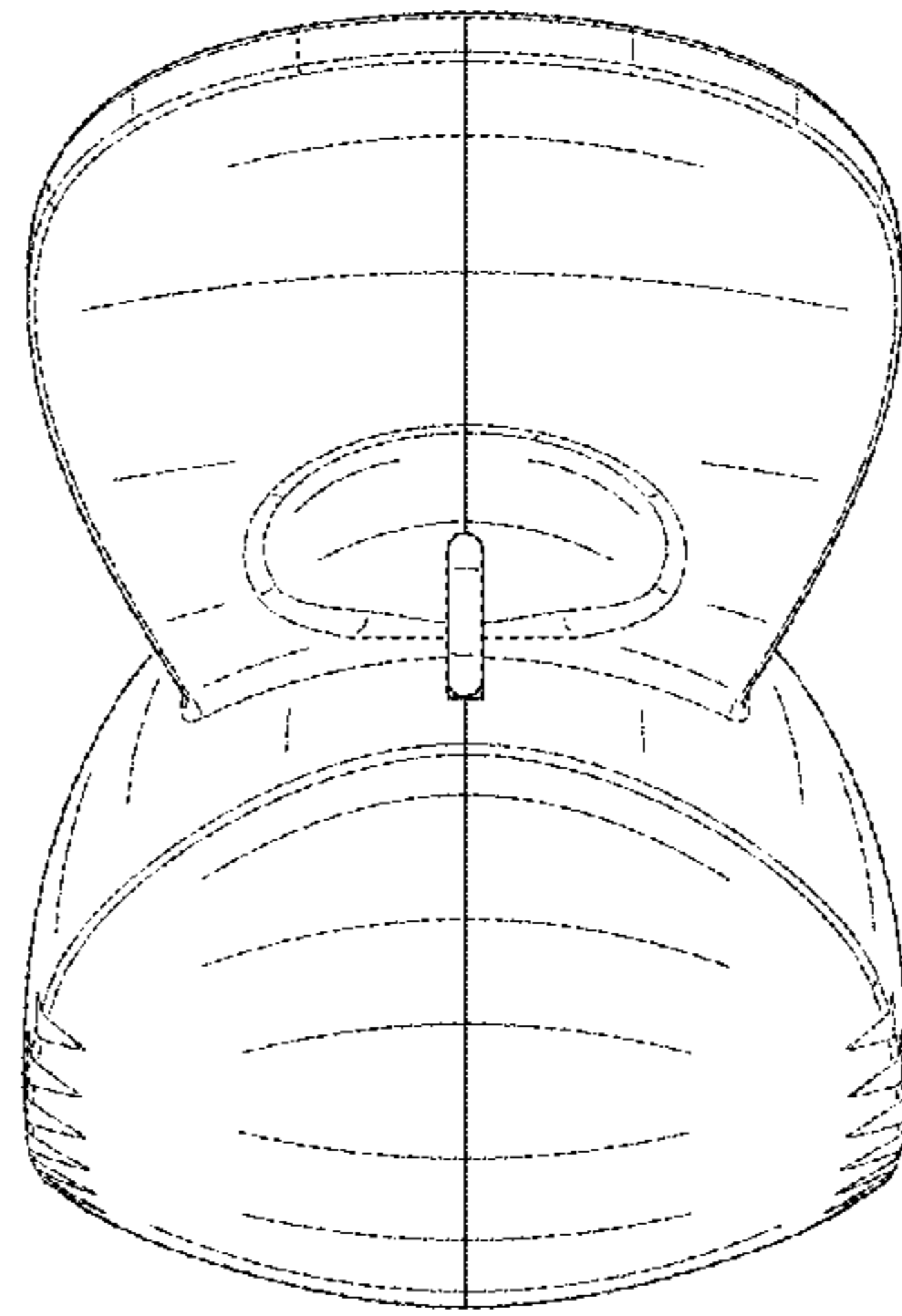

FIG. 2

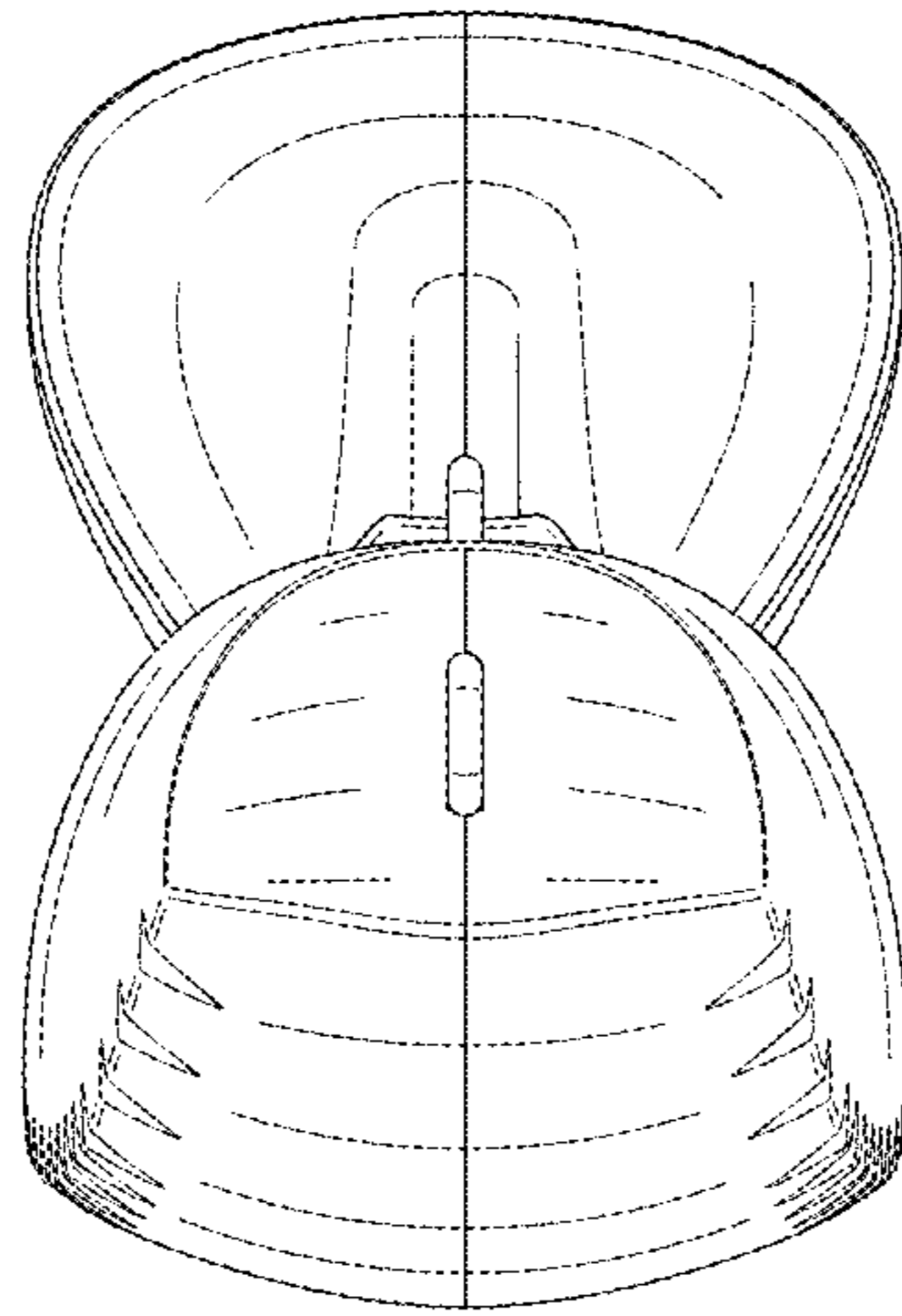

FIG. 3

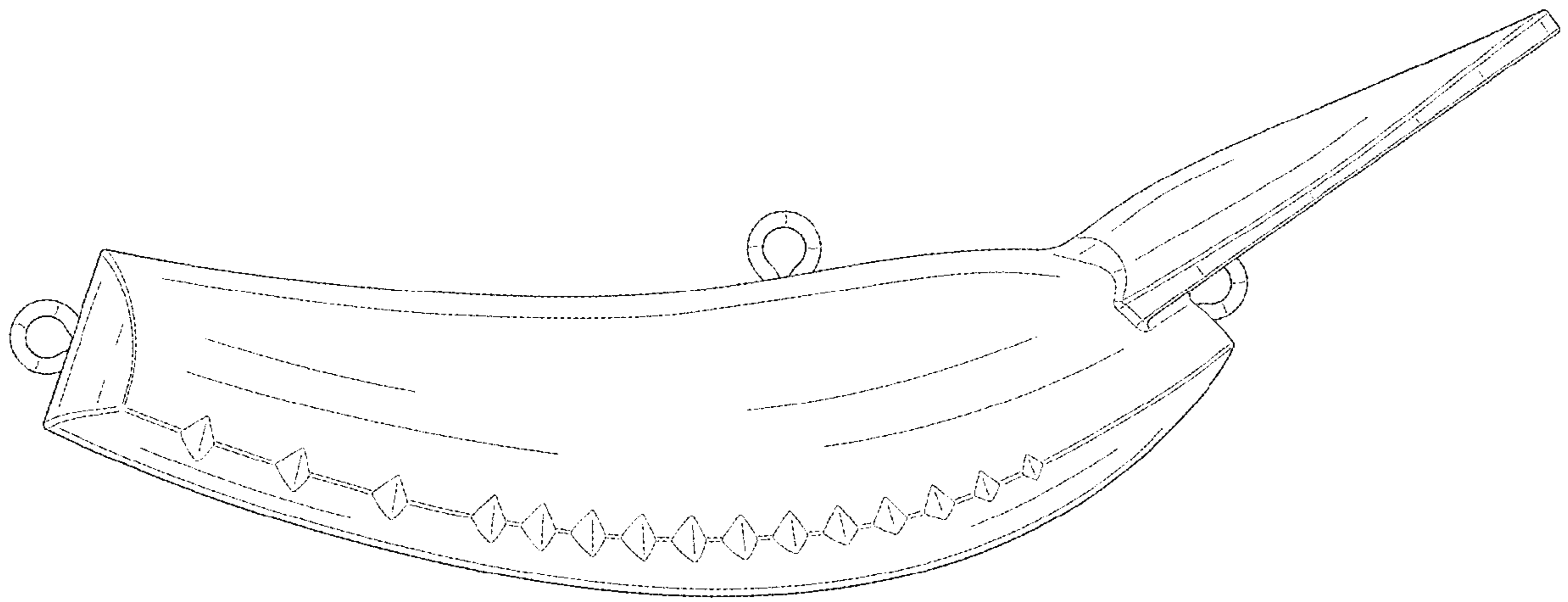

FIG. 4

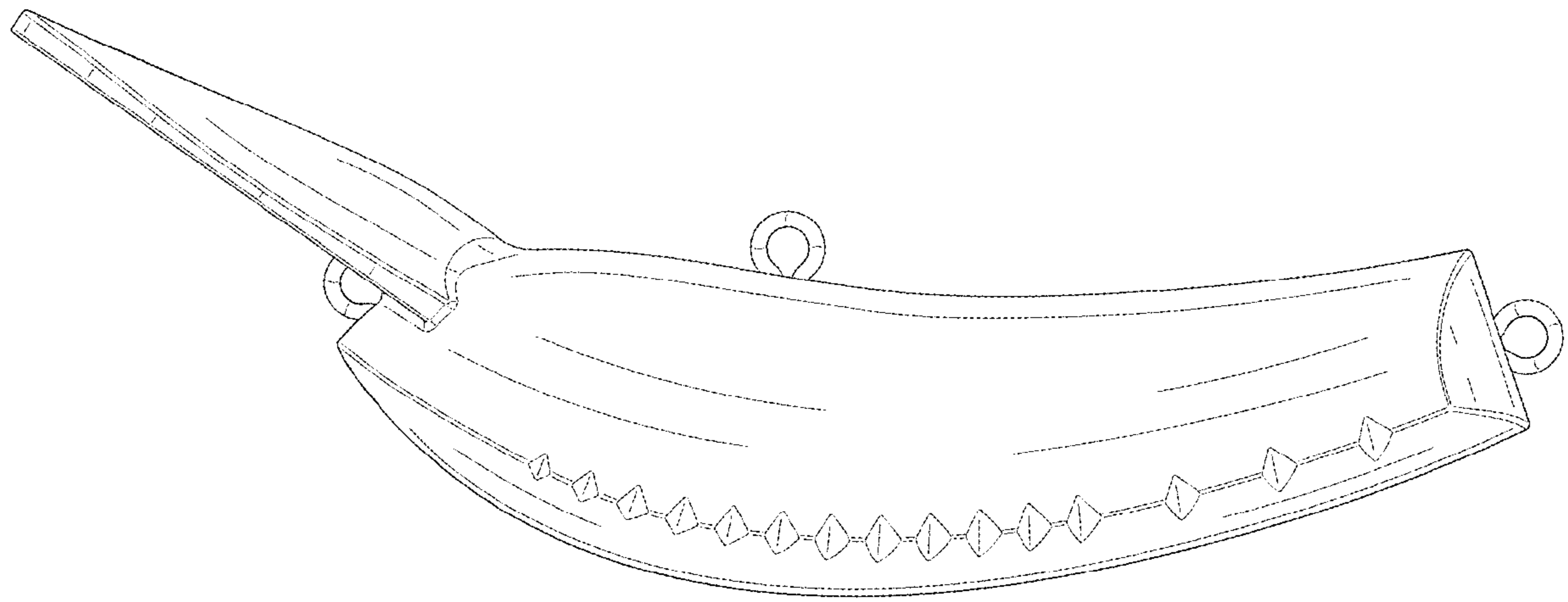

FIG. 5

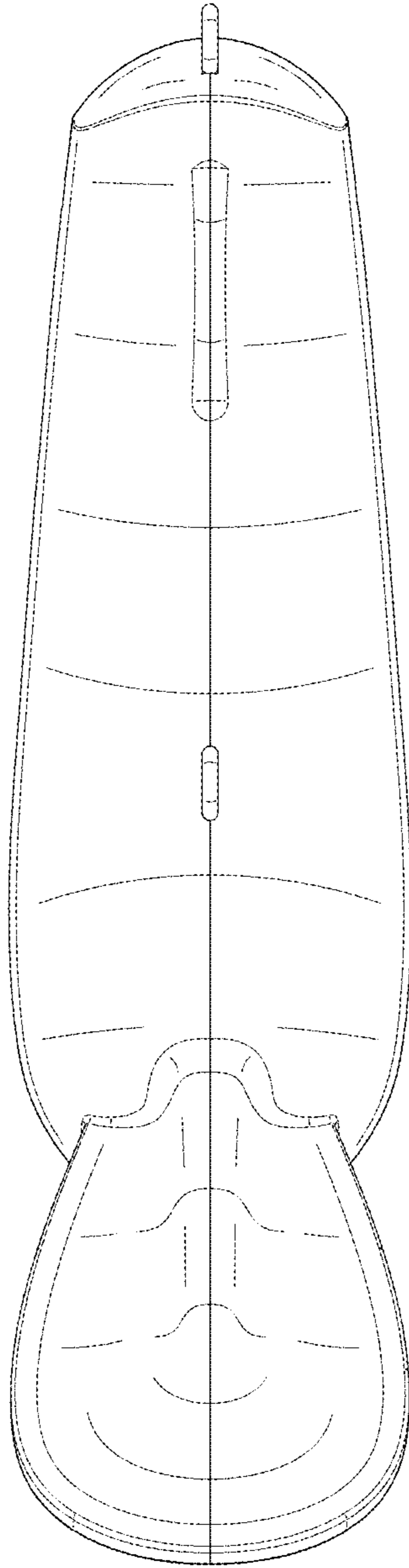

FIG. 6

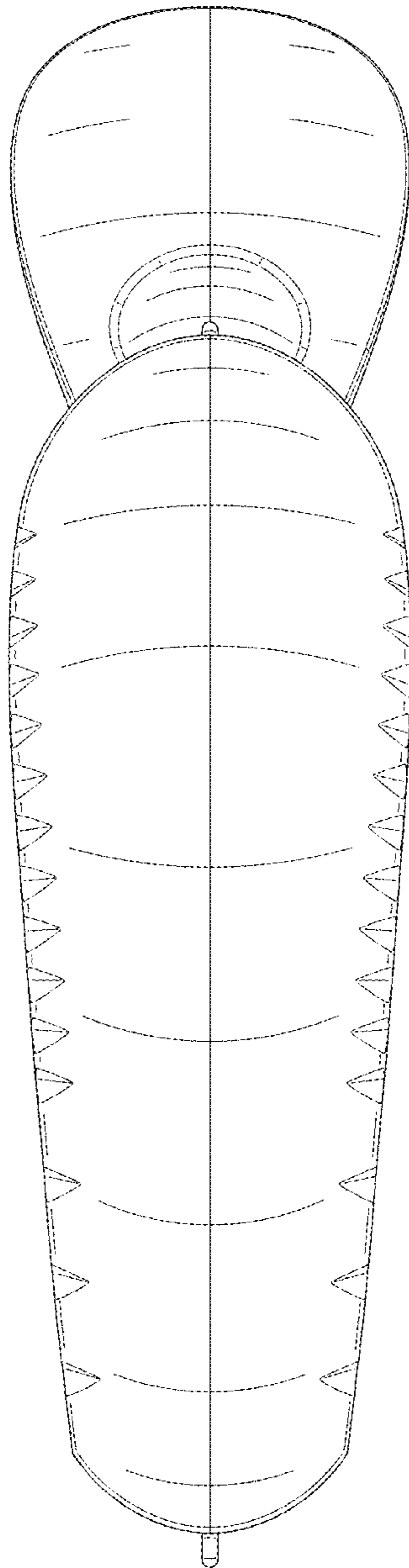

FIG. 7

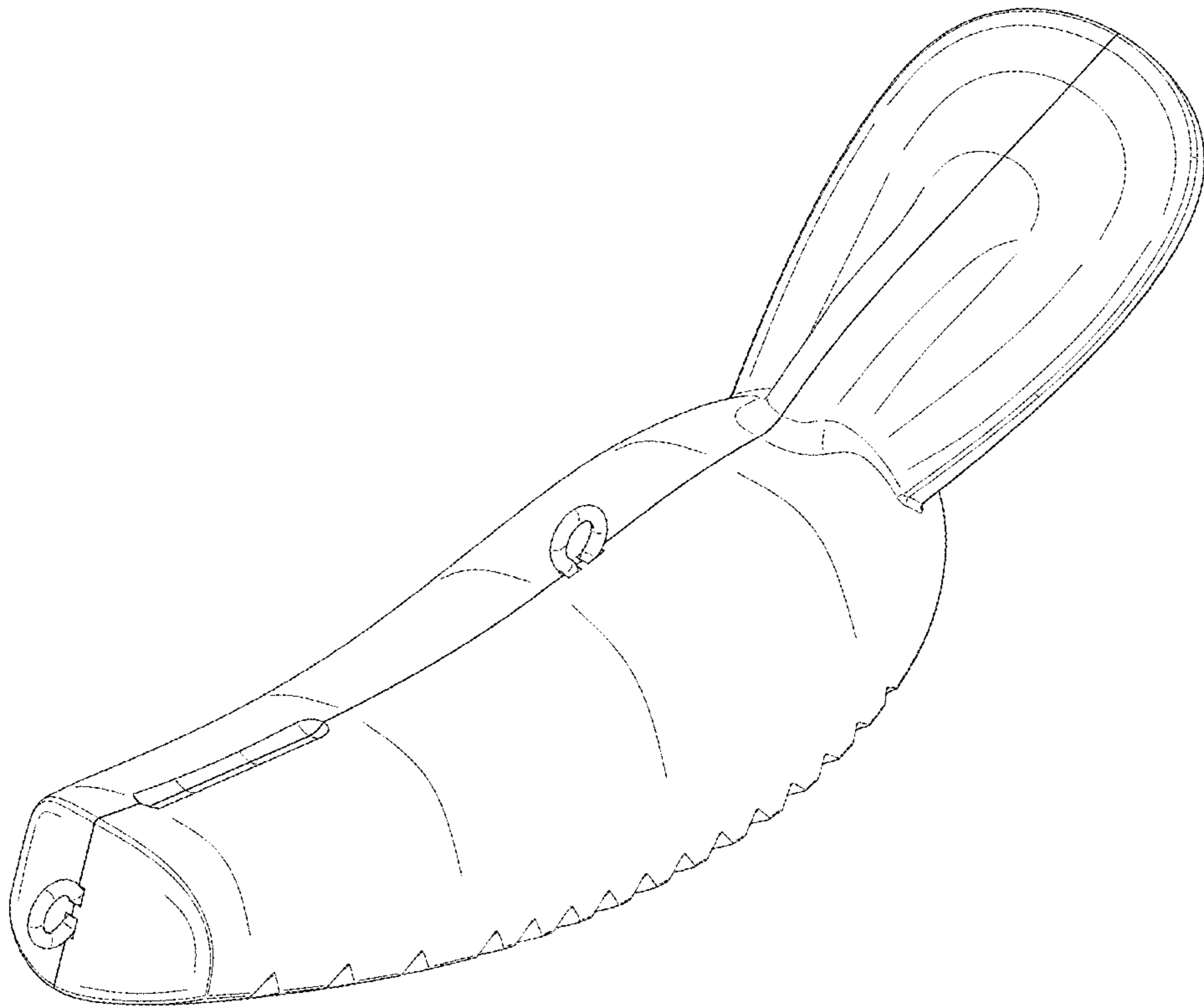

FIG. 8

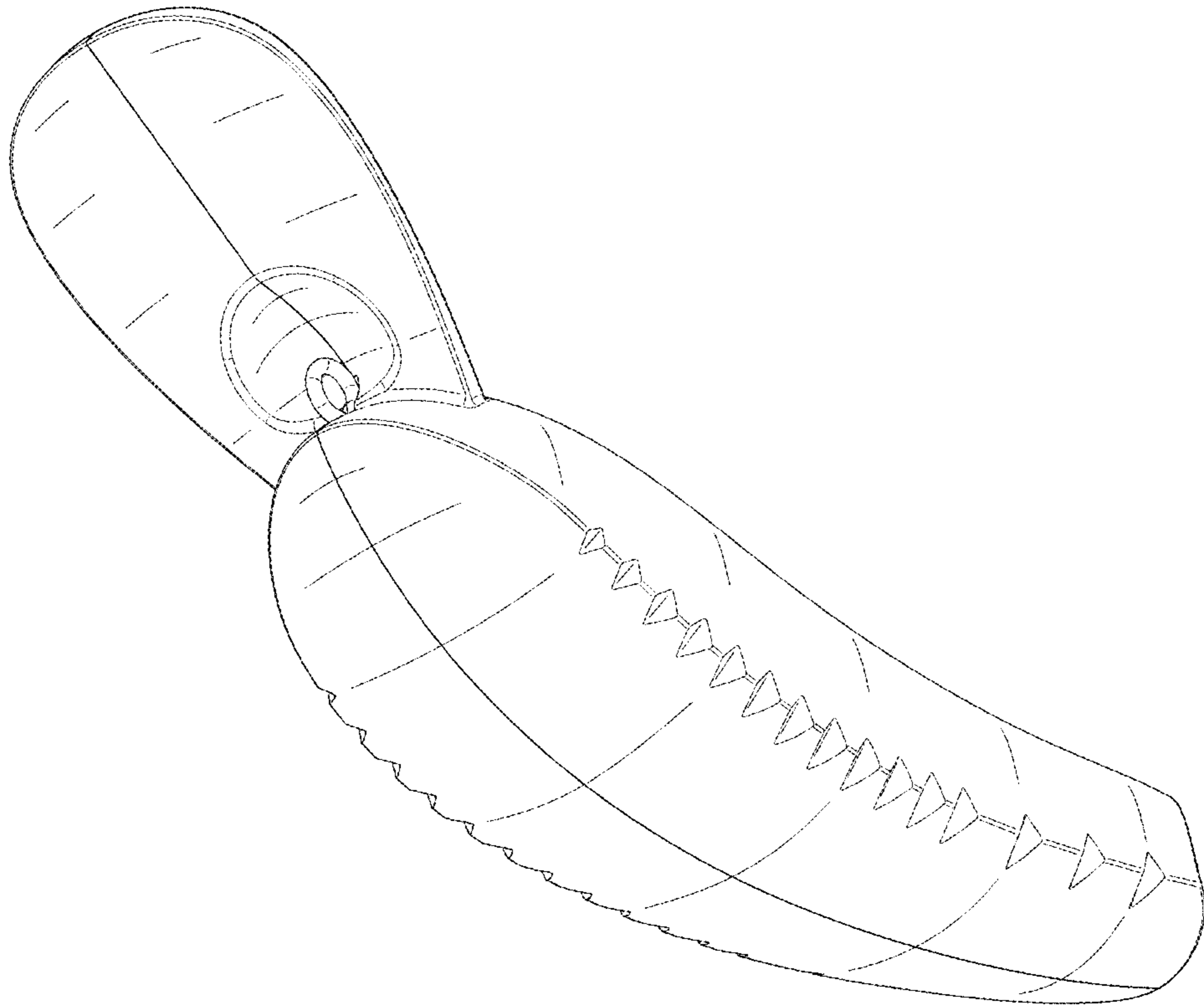

FIG. 9