



US00D947302S

(12) **United States Design Patent**
Harrington

(10) **Patent No.:** **US D947,302 S**

(45) **Date of Patent:** **** Mar. 29, 2022**

(54) **GOLF CLUB HEAD**

(71) Applicant: **James Patrick Harrington**, Solana Beach, CA (US)

(72) Inventor: **James Patrick Harrington**, Solana Beach, CA (US)

(73) Assignee: **JP GOLF ASIA**, Gwangju-si (KR)

(**) Term: **15 Years**

(21) Appl. No.: **29/746,868**

(22) Filed: **Aug. 18, 2020**

(30) **Foreign Application Priority Data**

May 11, 2020 (KR) 30-2020-0020295

(51) **LOC (13) Cl.** **21-02**

(52) **U.S. Cl.**
USPC **D21/747**

(58) **Field of Classification Search**

USPC D21/747-751, 759

CPC A63B 53/00; A63B 53/02; A63B 53/04;
A63B 53/047; A63B 53/0475; A63B
2053/0479; A63B 2053/0483; A63B
2053/0445; A63B 60/00; A63B 60/46

See application file for complete search history.

(56) **References Cited**

U.S. PATENT DOCUMENTS

D404,783 S * 1/1999 Best D21/753
D574,914 S * 8/2008 Oldknow D21/759
D577,399 S * 9/2008 Oldknow D21/759
D583,433 S * 12/2008 Oldknow D21/759
D703,282 S * 4/2014 Breier D21/747

D704,288 S * 5/2014 Cardani D21/747
D760,333 S * 6/2016 Harrington D21/747
D767,057 S * 9/2016 Mickelson D21/747
D783,747 S * 4/2017 Harrington D21/747
D807,456 S * 1/2018 Harrington D21/759
D833,548 S * 11/2018 Harrington D21/747
D833,552 S * 11/2018 Dolezel D21/759
D835,739 S * 12/2018 Long D21/759
D860,364 S * 9/2019 Seagram D21/759
D864,326 S * 10/2019 Mickelson D21/747
D911,470 S * 2/2021 Harrington D21/748
D911,471 S * 2/2021 Harrington D21/748
D911,472 S * 2/2021 Harrington D21/759
2018/0272198 A1 * 9/2018 Harrington A63B 53/047

* cited by examiner

Primary Examiner — Mitchell I. Siegel

(74) *Attorney, Agent, or Firm* — John K. Park; Park Law Firm

(57) **CLAIM**

The ornamental design for a golf club head, as shown and described.

DESCRIPTION

FIG. 1 is a perspective view of the golf club head showing my new design;

FIG. 2 is a front elevation view thereof;

FIG. 3 is a left-side elevation view thereof;

FIG. 4 is a right-side elevation view thereof;

FIG. 5 is a top-side plan view thereof;

FIG. 6 is a bottom plan view thereof;

FIG. 7 is a rear elevation view thereof; and,

FIG. 8 is an enlarged view of the part golf club head as a reference.

The broken lines in the drawings depict portions of golf club head that form no part of the claimed design.

1 Claim, 8 Drawing Sheets

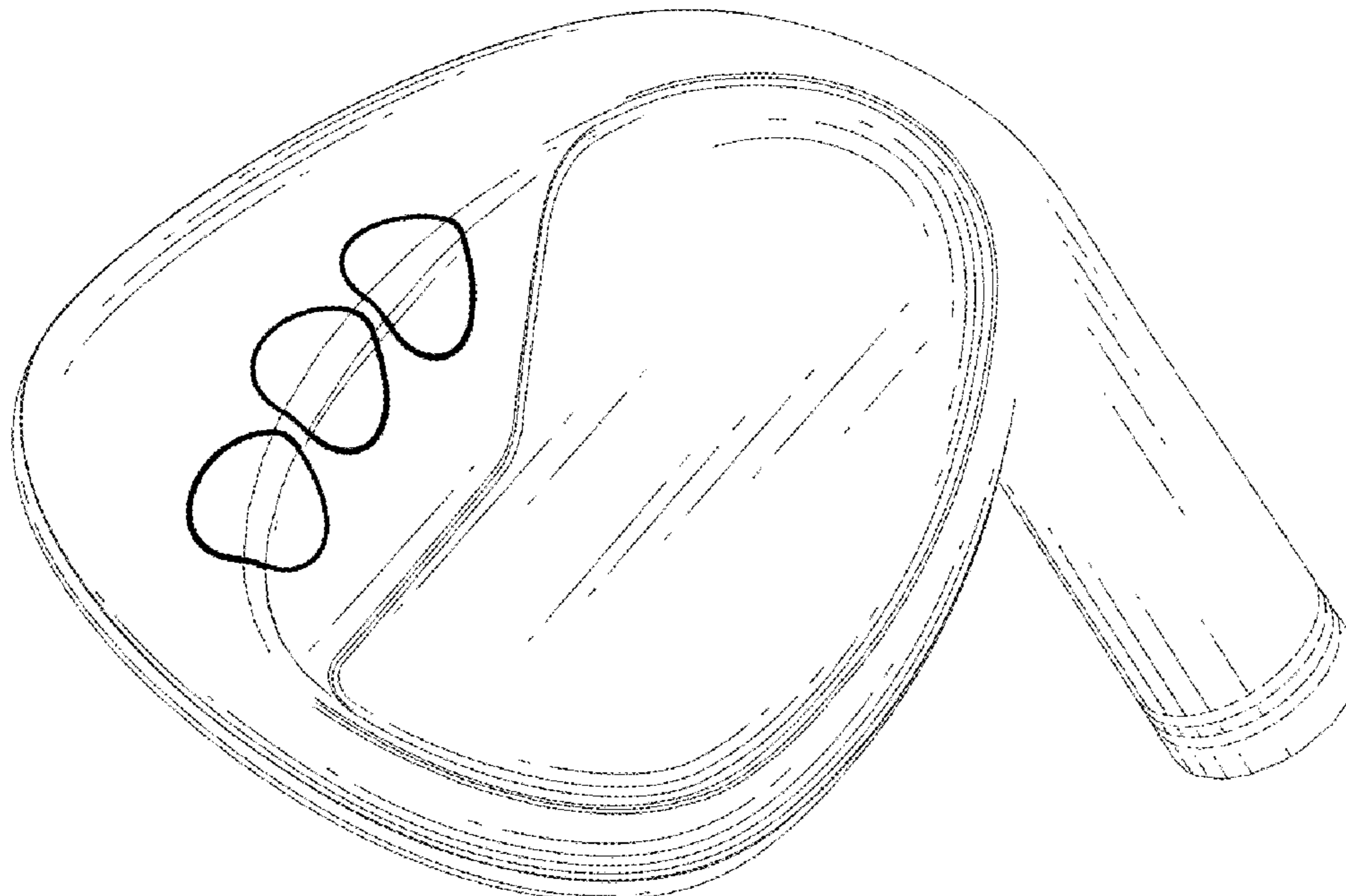

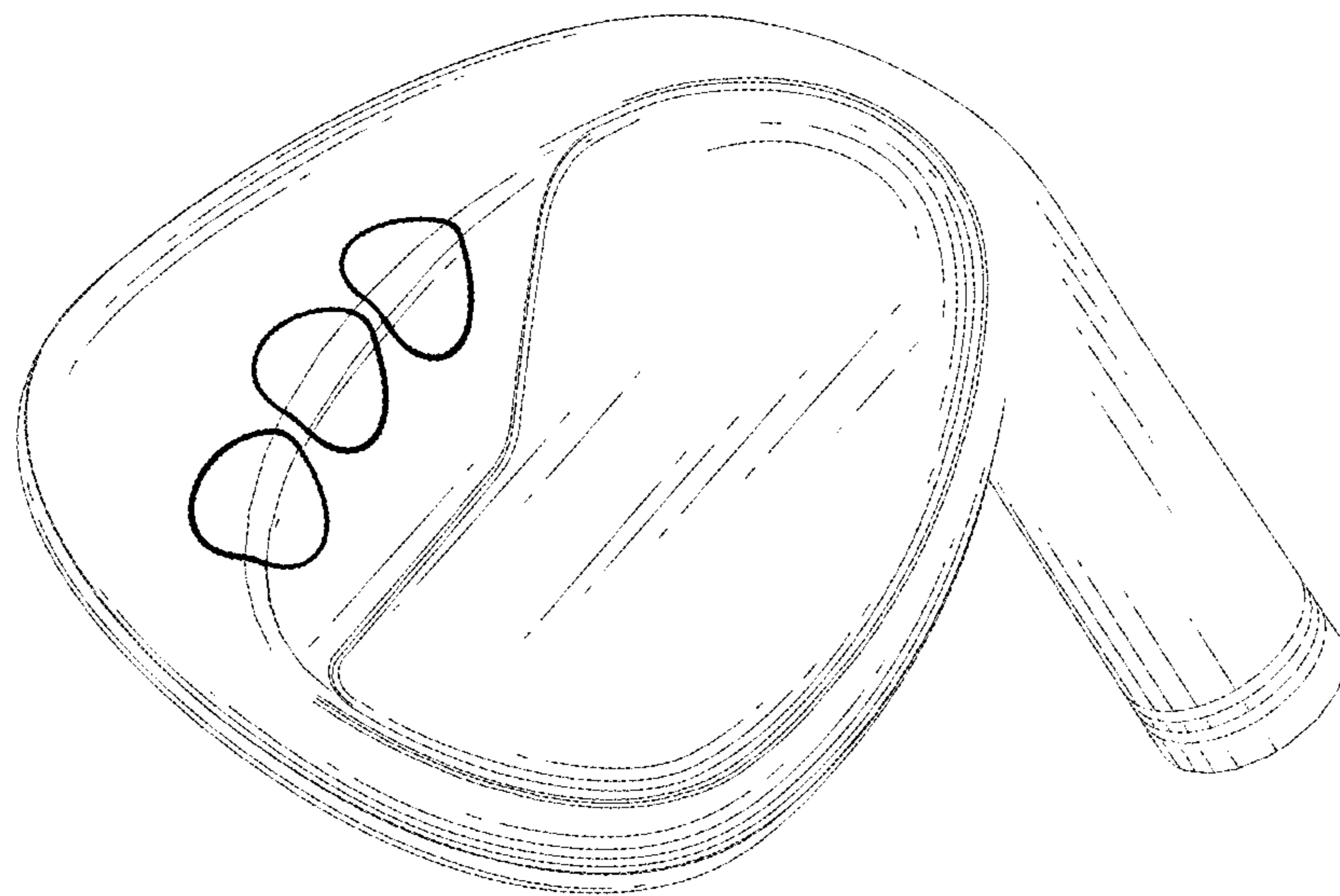

FIG. 1

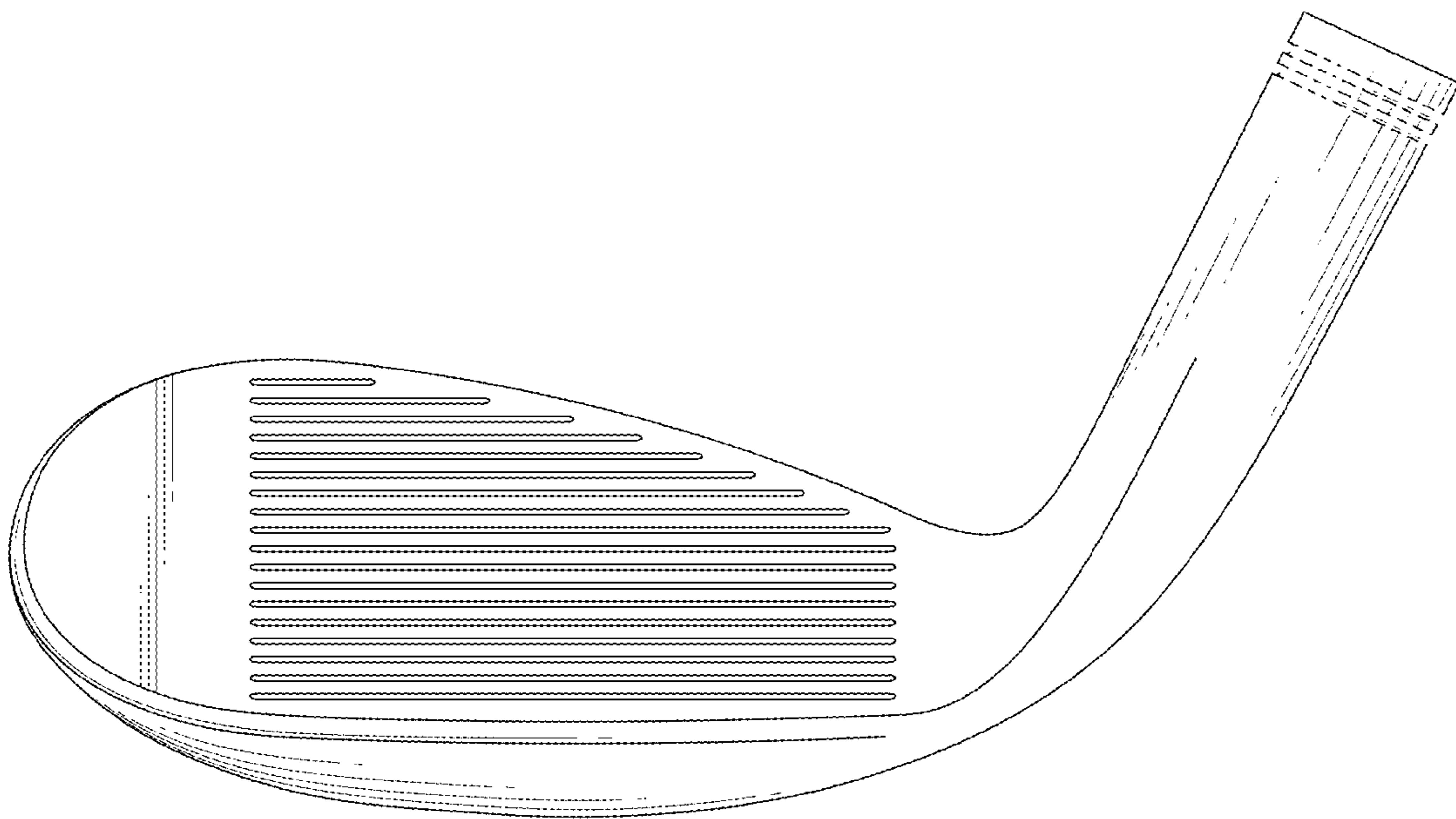

FIG. 2

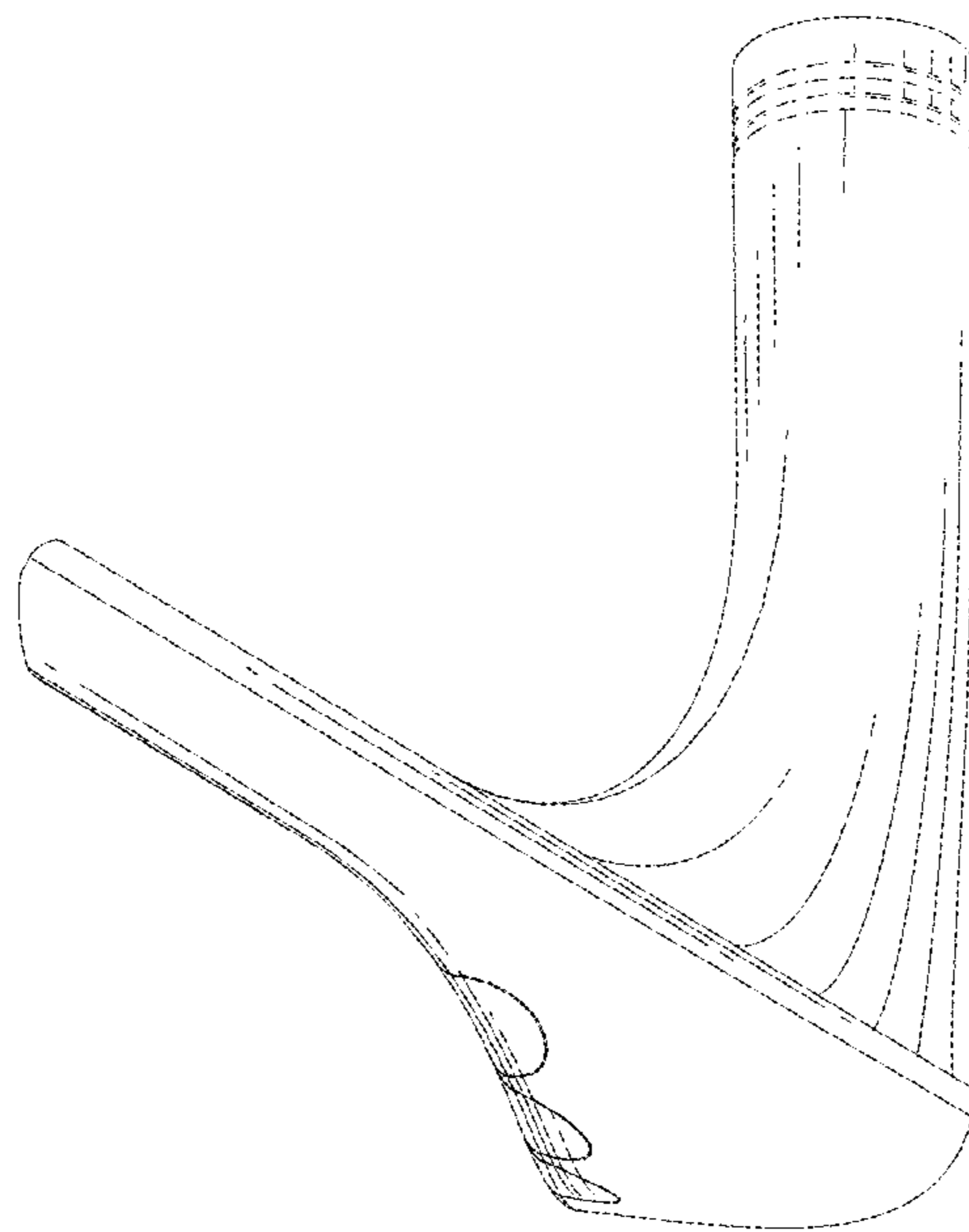

FIG. 3

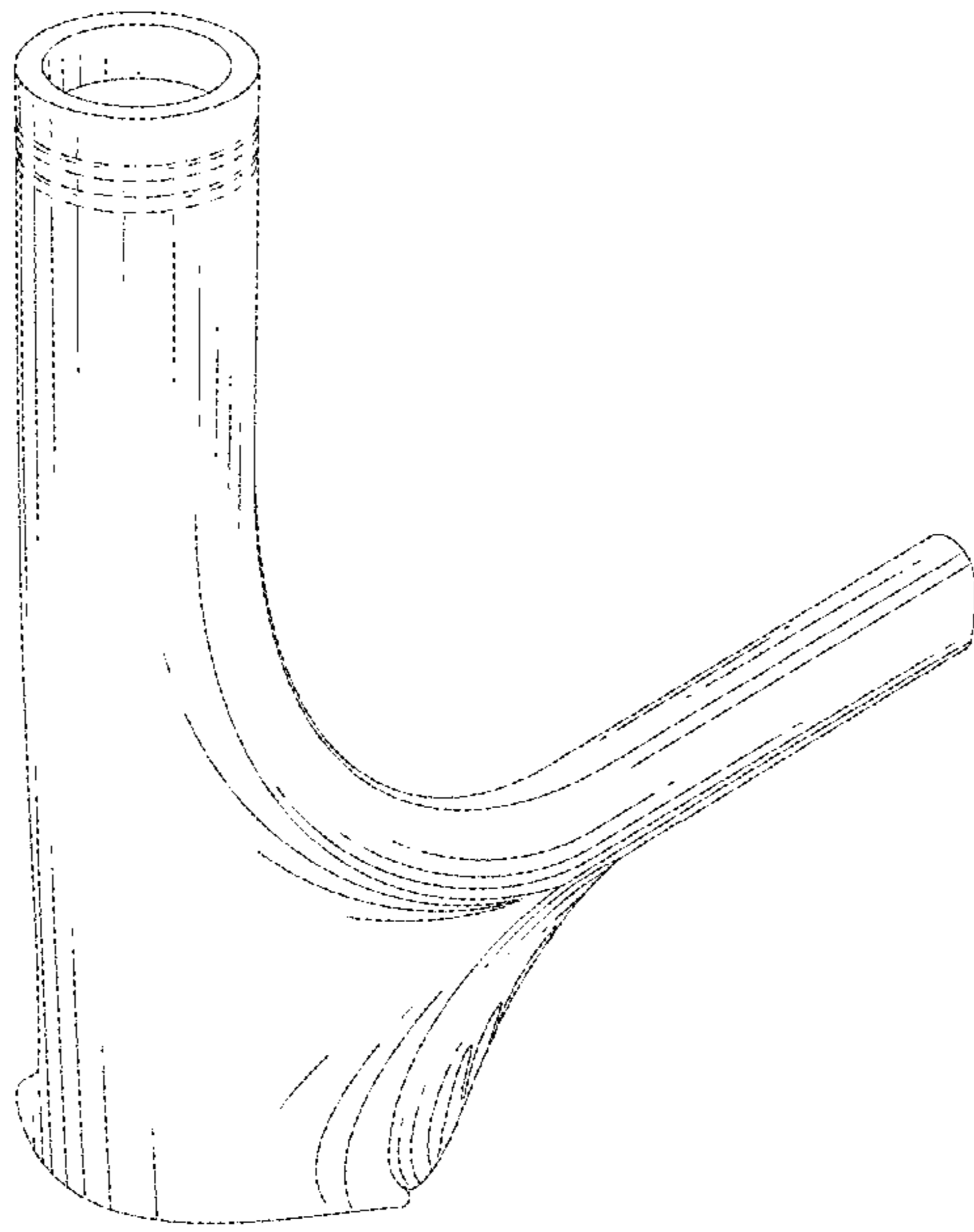

FIG. 4

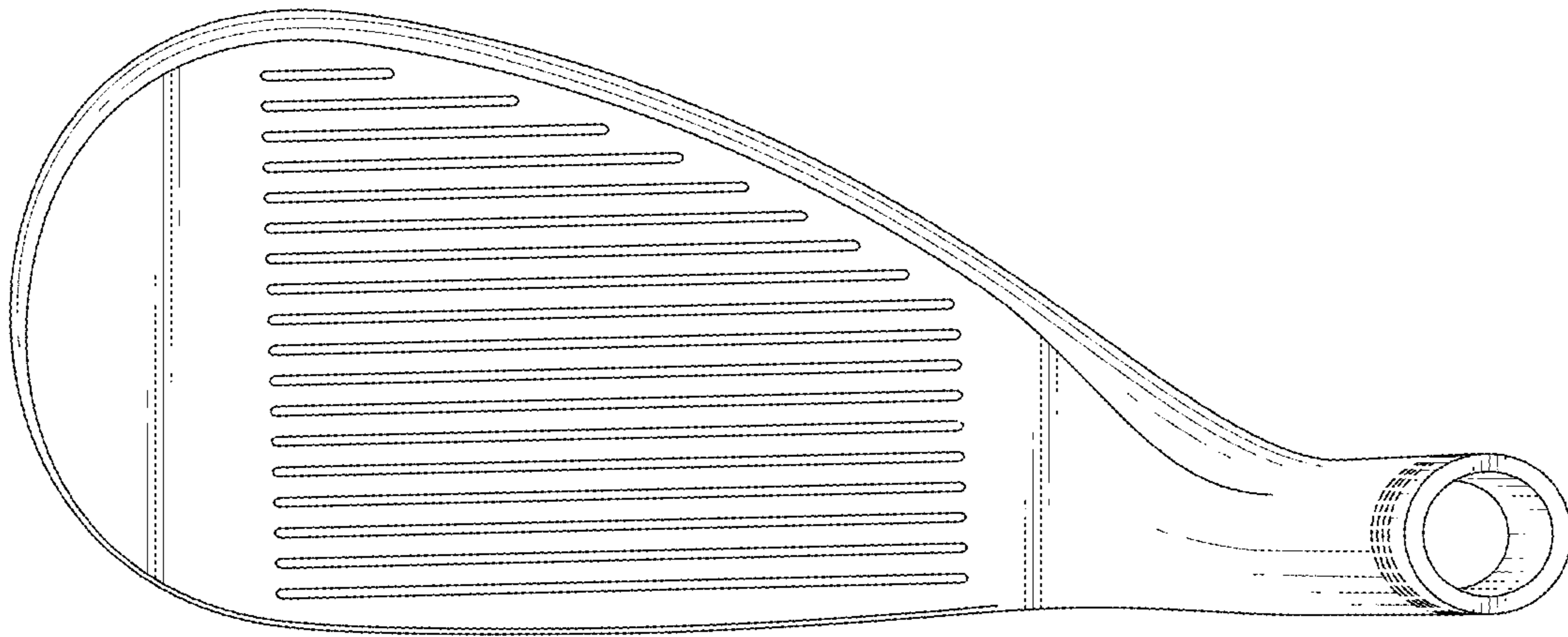

FIG. 5

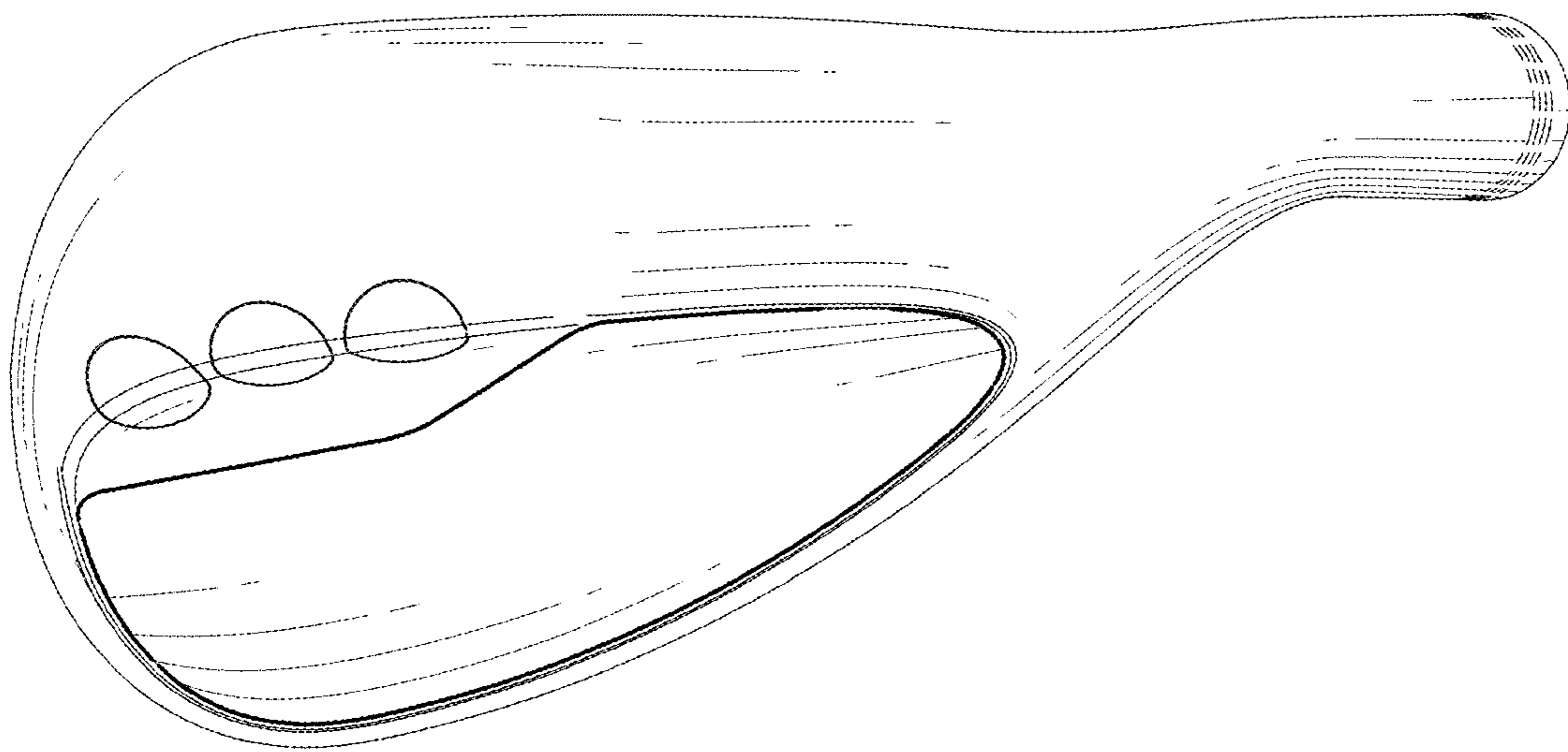

FIG. 6

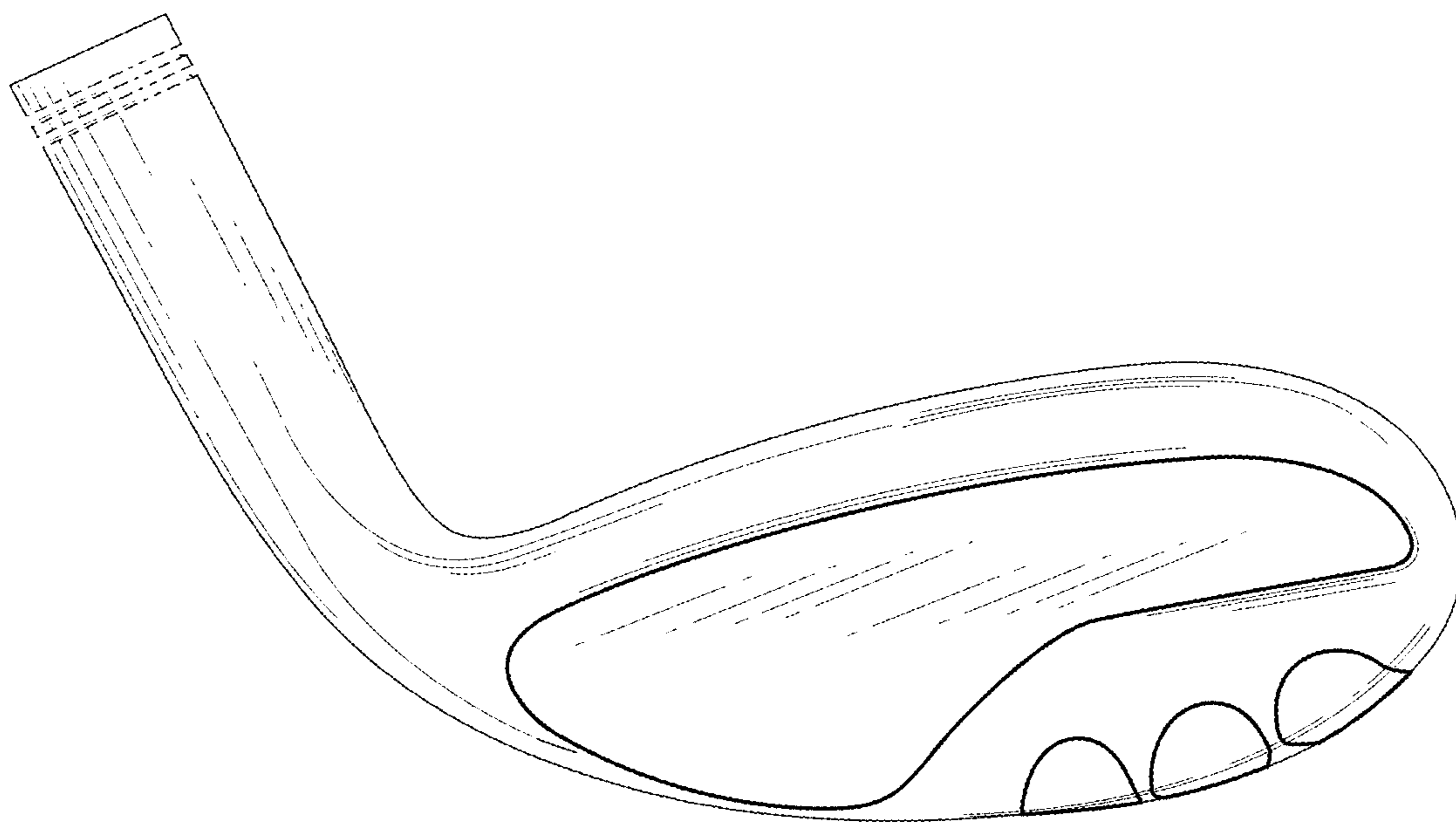

FIG. 7

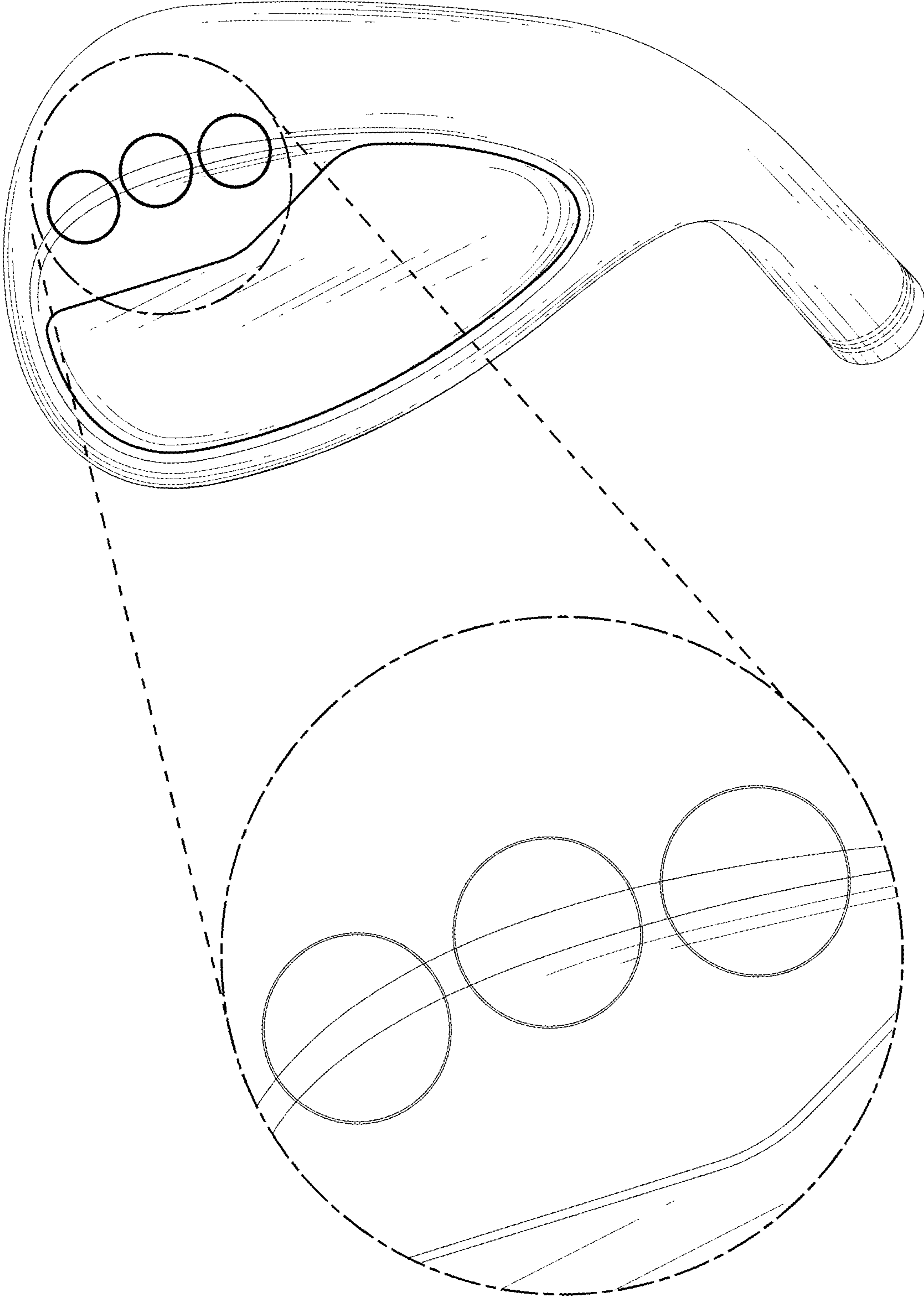

FIG. 8