



US00D947256S

(12) **United States Design Patent**
Myung et al.

(10) **Patent No.:** **US D947,256 S**
(45) **Date of Patent:** **** Mar. 29, 2022**

(54) **DOOR FOR ENTRYWAY WITH REFRIGERATOR AND DELIVERY STORAGE BOX**

F25D 23/025; F25D 23/04; F25D 27/00; F25D 23/062; F25D 23/067; F25D 2400/18; F25D 23/08; F25D 23/085; F25D 2500/02; F25D 25/00; F25D 25/005; F25D 25/022; F25D 25/024; F25D 17/047; F25D 2317/041; F25D 2317/04131; F25D 2317/043; F25D 2317/0664; F25D 2321/147; F25D 2323/02; F25D 2323/023

(71) Applicant: **LG ELECTRONICS INC.**, Seoul (KR)

(72) Inventors: **Eugene Myung**, Seoul (KR); **Junghoon Lee**, Seoul (KR); **Hyunchul Kim**, Seoul (KR); **Insun Yeo**, Seoul (KR); **Wook Shin**, Seoul (KR); **Kiyeal Seo**, Seoul (KR)

See application file for complete search history.

(73) Assignee: **LG ELECTRONICS INC.**, Seoul (KR)

(**) Term: **15 Years**

(21) Appl. No.: **35/510,337**

(22) Filed: **Mar. 16, 2020**

(80) **Hague Agreement Data**

Int. Filing Date: **Mar. 16, 2020**
Int. Reg. No.: **DM/207485**
Int. Reg. Date: **Mar. 16, 2020**
Int. Reg. Pub. Date: **Sep. 18, 2020**

(30) **Foreign Application Priority Data**

Oct. 2, 2019 (KR) 30-2019-0047431

(51) **LOC (13) Cl.** **15-07**

(52) **U.S. Cl.**
USPC **D15/79**
CPC **F25D 25/025** (2013.01)

(58) **Field of Classification Search**

USPC D15/79-91; 312/112-119, 236, 352, 312/400-408; 62/3.1, 3.6, 3.63, 3.64, 62/293, 31, 371, 400, 467, 529, 531
CPC F25D 25/025; F25D 23/028; F25D 2323/024; F25D 23/00; F25D 23/02; F25D 2323/021; F25D 23/065; F25D 11/00; F25D 2201/14; F25D 23/021;

(56) **References Cited**

U.S. PATENT DOCUMENTS

2,404,851 A * 7/1946 Knowles F25D 25/025
312/286
2,421,439 A * 6/1947 Smith F25D 13/02
62/382
3,089,313 A * 5/1963 Fix F25D 13/02
62/239
5,474,213 A * 12/1995 Unger F25C 5/22
222/108

(Continued)

Primary Examiner — Richard E Chilcot

(74) *Attorney, Agent, or Firm* — Birch, Stewart, Kolasch & Birch, LLP

(57) **CLAIM**

The ornamental design for a door for entryway with refrigerator and delivery storage box, as shown and described.

DESCRIPTION

1. Door for Entryway with Refrigerator and Delivery Storage Box

- 1.1 : Perspective
- 1.2 : Back
- 1.3 : Front
- 1.4 : Left
- 1.5 : Right
- 1.6 : Top
- 1.7 : Bottom
- 1.8 : Perspective view

The broken lines illustrate environmental condition only and form no part thereof.

1 Claim, 8 Drawing Sheets

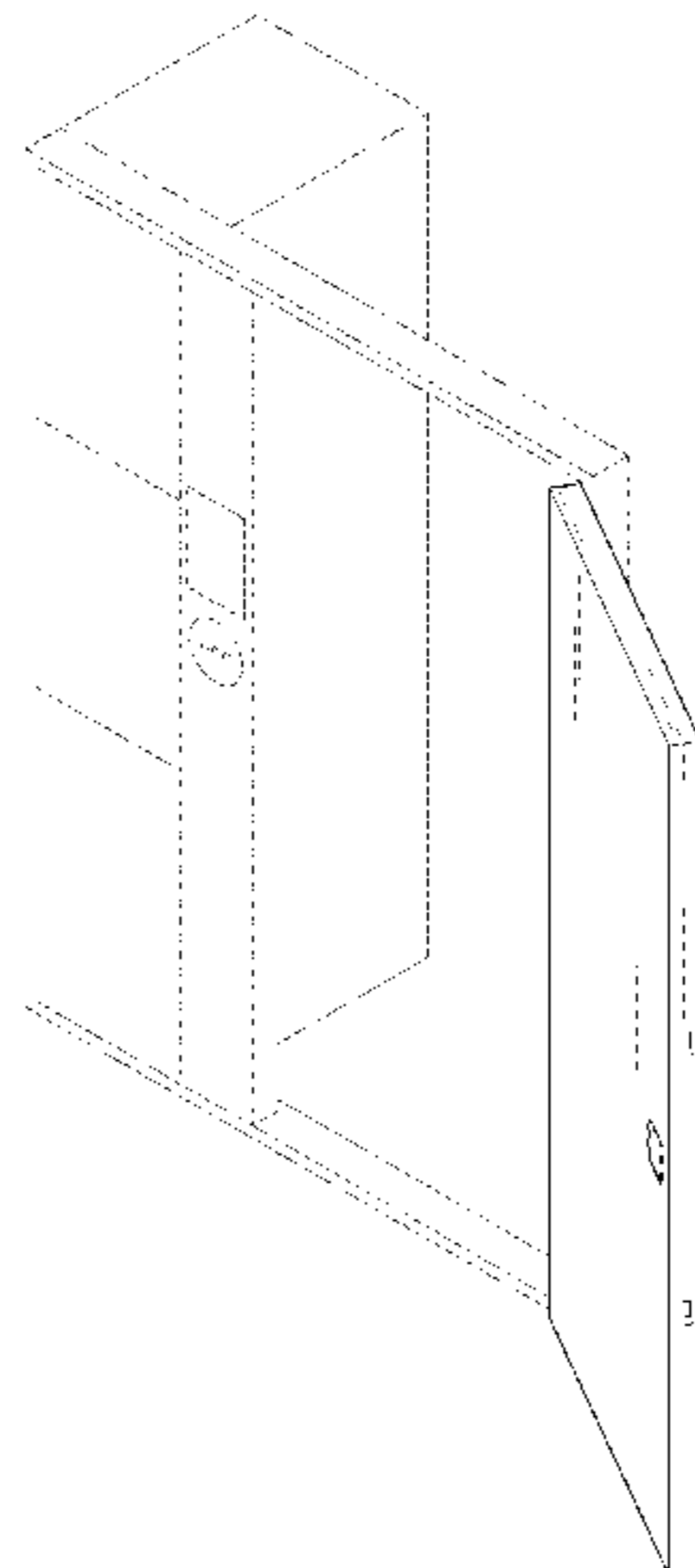

(56)

References Cited

U.S. PATENT DOCUMENTS

D443,625 S *	6/2001	Vazquez	D15/86	2008/0036238 A1 *	2/2008	Weeda	B60P 3/20
D471,568 S *	3/2003	Smith	D15/85					296/146.1
D544,000 S *	6/2007	Ohtake	D15/81	2008/0278335 A1 *	11/2008	Welte	G07C 9/28
D669,103 S *	10/2012	Behr	D15/91					340/573.3
D671,573 S *	11/2012	Behr	D15/91	2009/0236954 A1 *	9/2009	Kobayashi	A47F 3/0404
8,496,308 B2 *	7/2013	Zablatino	G06Q 30/0645					312/36
				312/407	2010/0256800 A1 *	10/2010	Heffron	G07F 11/62
8,814,286 B2 *	8/2014	Ward	F25D 25/024					700/214
				312/404	2012/0206029 A1 *	8/2012	Zablatino	F25D 23/025
D880,543 S *	4/2020	Luchetta	D15/91					312/404
D905,766 S *	12/2020	Vernon	D15/79	2012/0209763 A1 *	8/2012	Zablatino	G06Q 30/0645
D918,055 S *	5/2021	Smith, Jr.	D9/636					705/39
D924,278 S *	7/2021	Choi	F25D 25/025	2017/0061373 A1 *	3/2017	Hara	A47G 29/141
				D15/79	2017/0188542 A1 *	7/2017	Dix	A01K 1/035
2003/0005716 A1 *	1/2003	Doran	F25D 23/10	2017/0286905 A1 *	10/2017	Richardson	G06Q 10/0832
				62/263	2018/0172337 A1 *	6/2018	Choi	F25D 23/02
2006/0179724 A1 *	8/2006	Lee	G07C 9/27	2019/0257556 A1 *	8/2019	Pinet	A47F 3/0434
				52/79.1	2019/0271500 A1 *	9/2019	Lee	G02B 6/0091
					2021/0217261 A1 *	7/2021	Green	G08C 17/02

* cited by examiner

1.1

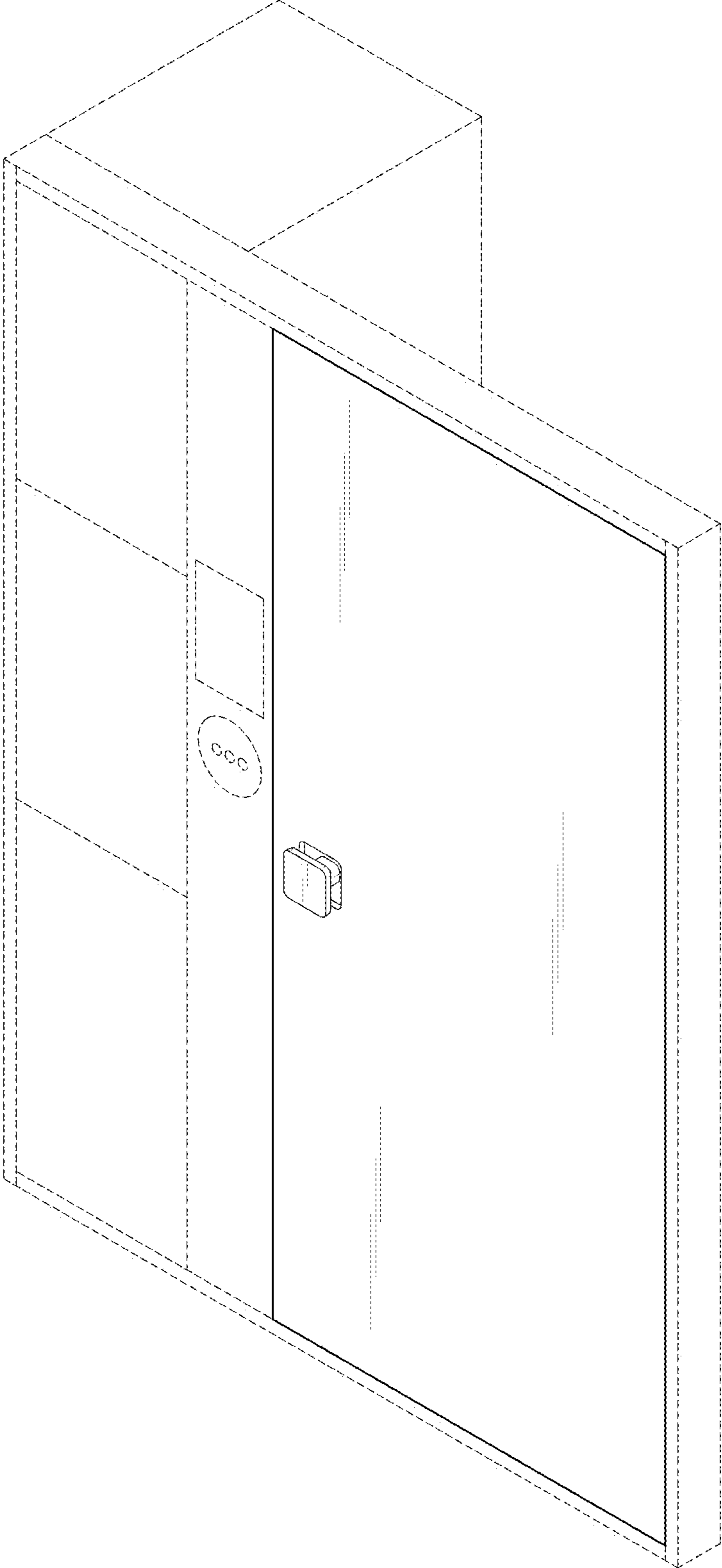

1.2

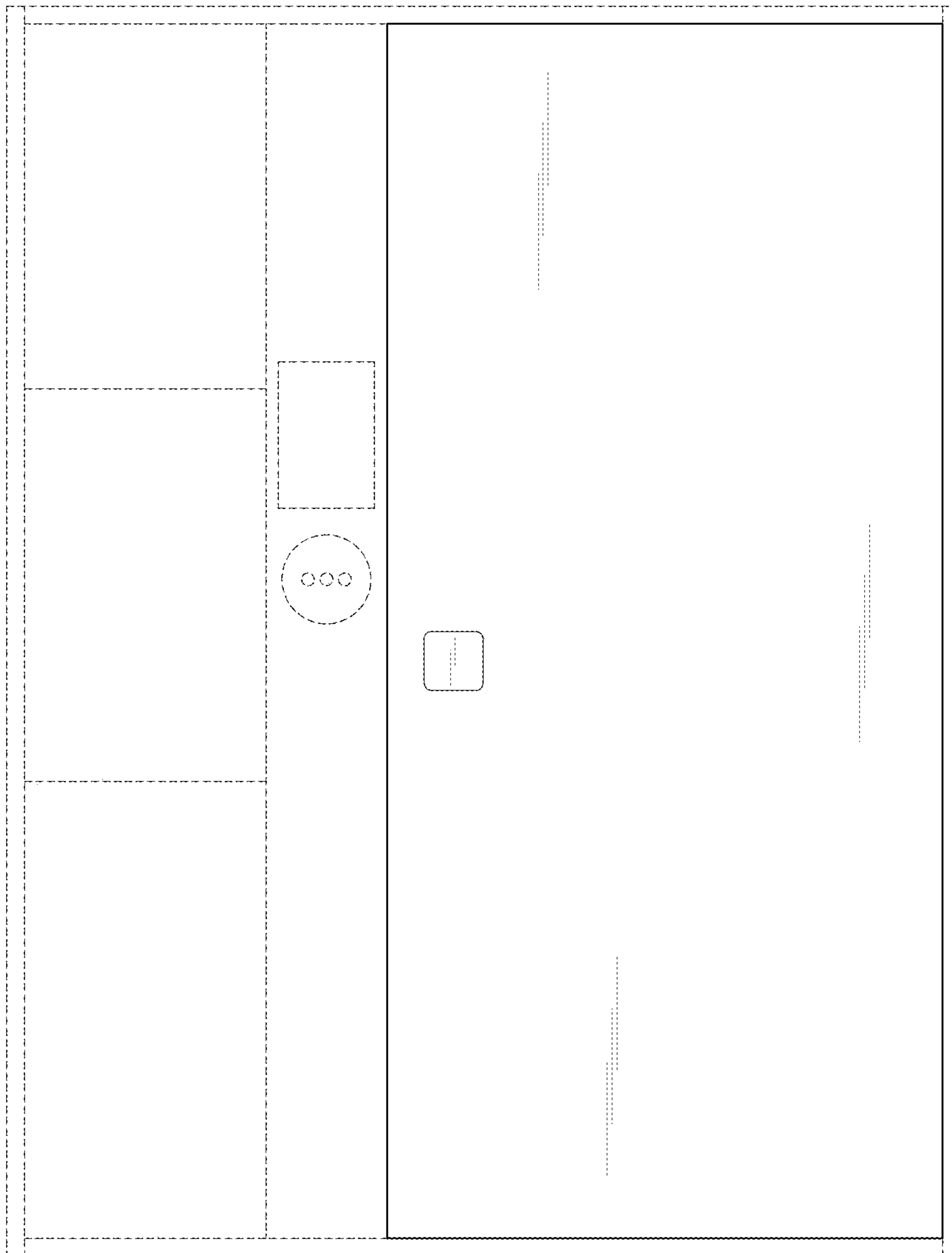

1.3

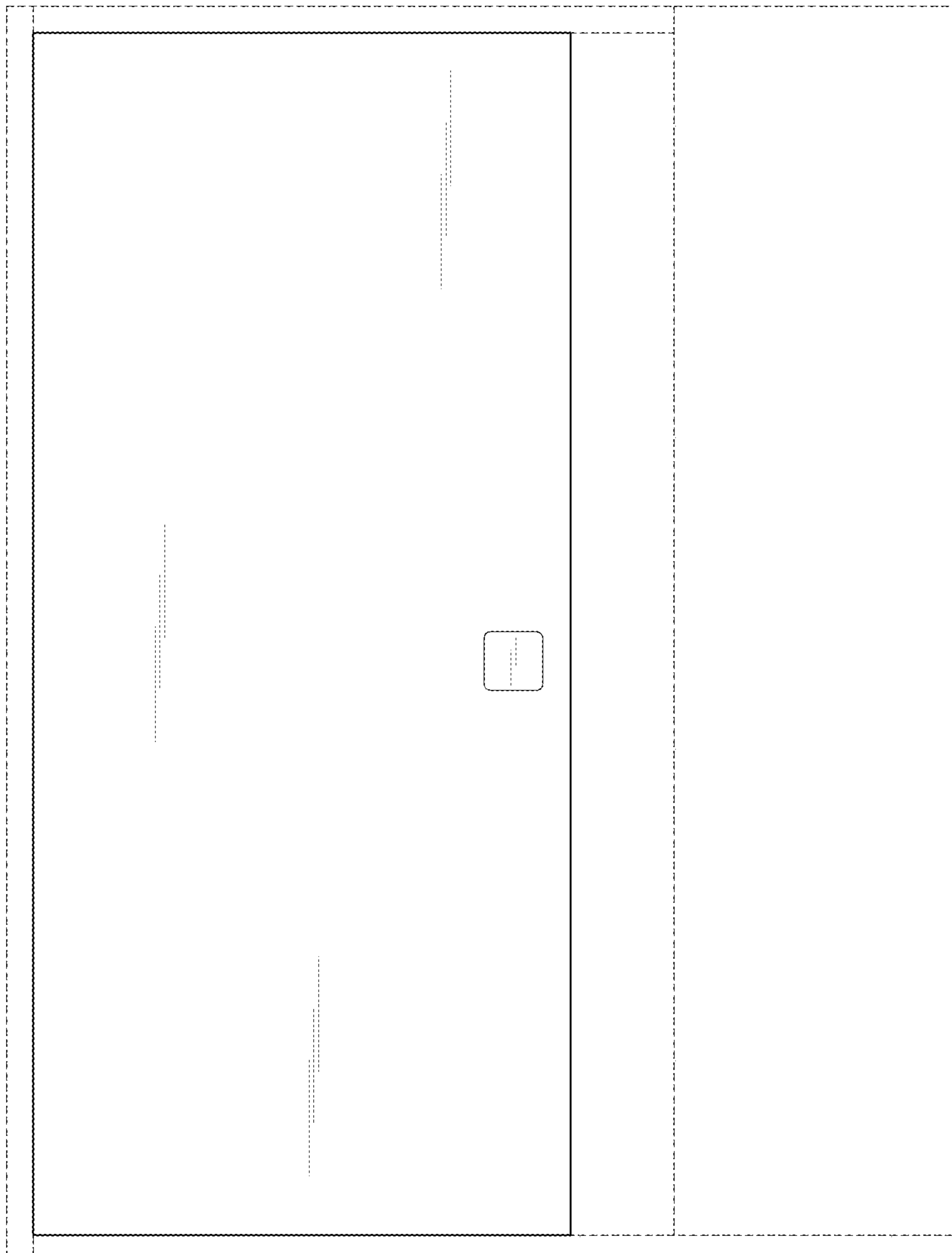

1.4

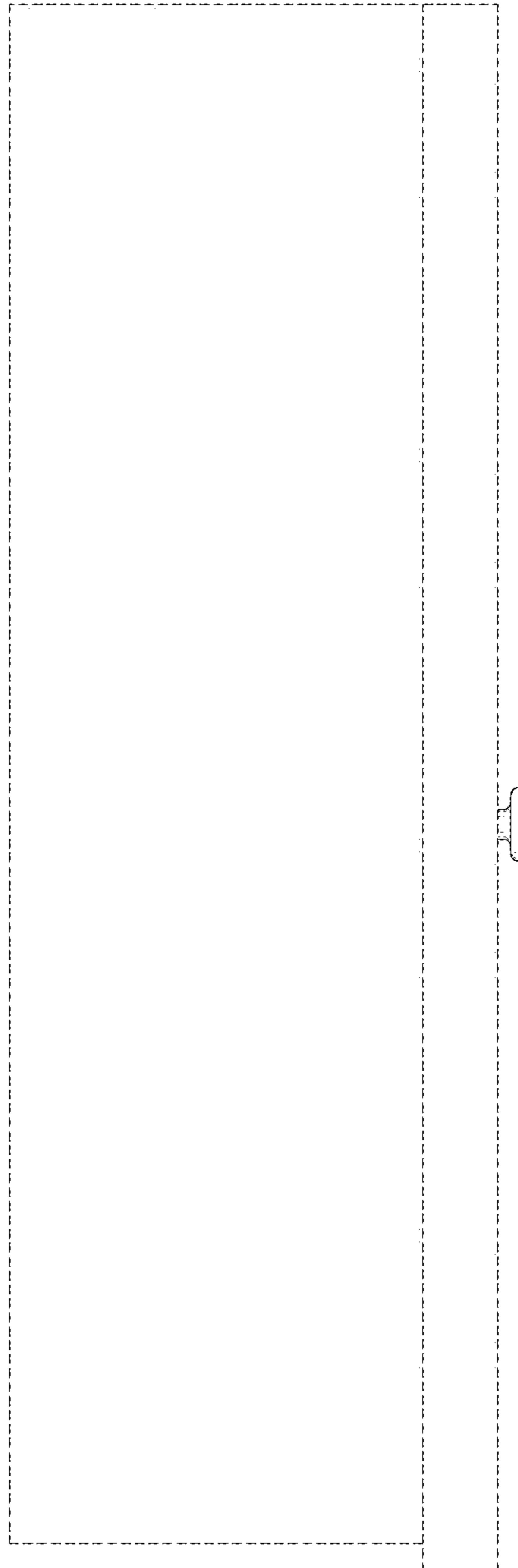

1.5

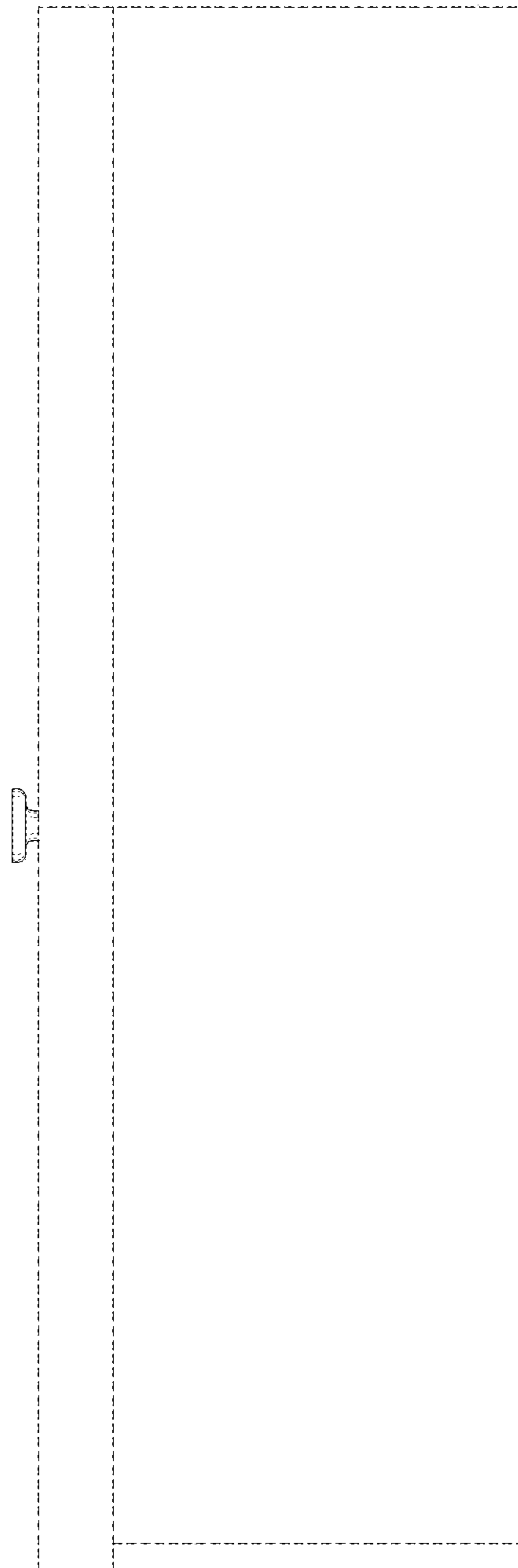

1.6

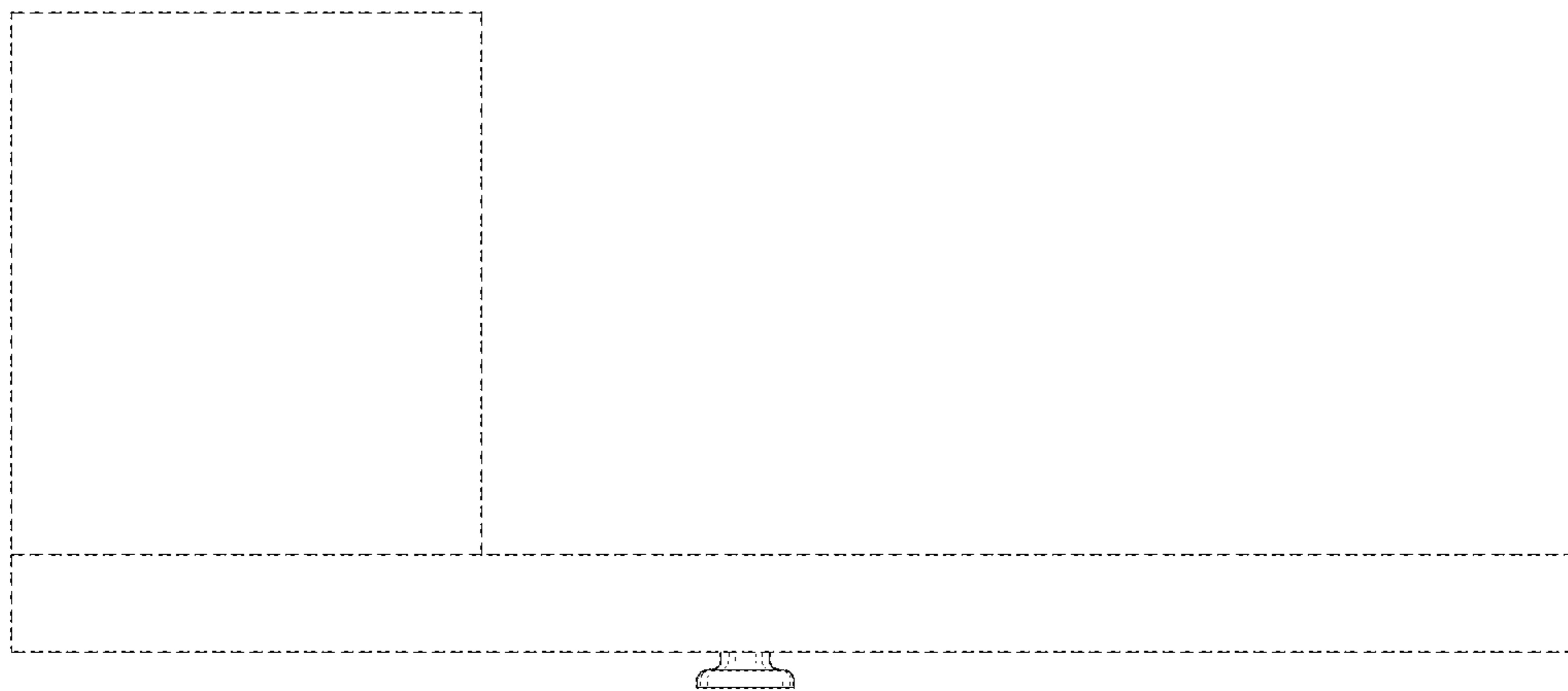

1.7

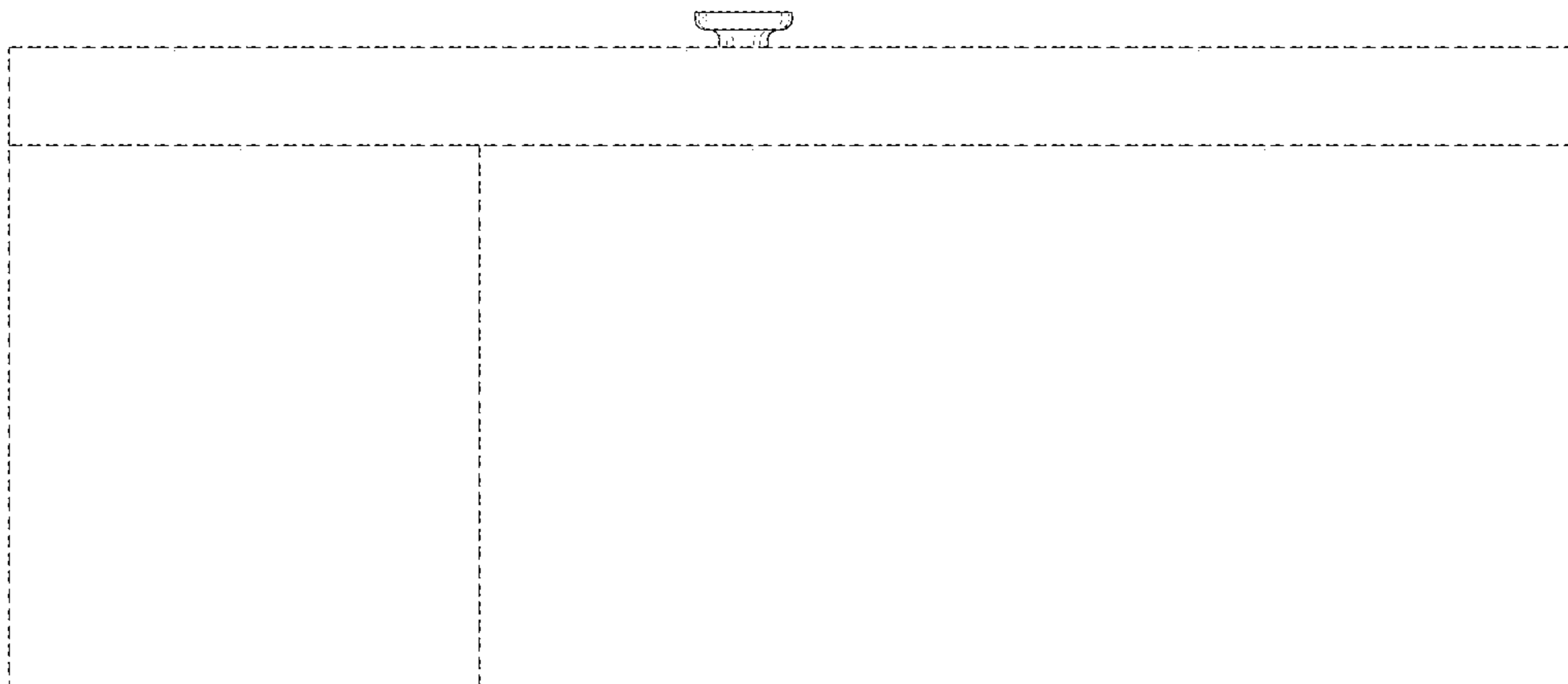

1.8

