



US00D947074S

(12) **United States Design Patent**
Hu et al.

(10) **Patent No.:** **US D947,074 S**
(45) **Date of Patent:** **** Mar. 29, 2022**

(54) **ELECTRIC BICYCLE**
(71) Applicant: **BEIJING NIU INFORMATION TECHNOLOGY CO., LTD.**, Beijing (CN)
(72) Inventors: **Yilin Hu**, Beijing (CN); **Chuankai Liu**, Beijing (CN); **Kai Yang**, Beijing (CN); **Yalan Liu**, Beijing (CN); **Yuancheng Liu**, Beijing (CN); **Yunqi Li**, Beijing (CN)

D406,253 S * 3/1999 Yamashita D12/110
D441,323 S * 5/2001 Cheng D12/111
D470,438 S * 2/2003 Tateishi D12/110
D538,714 S * 3/2007 Okuyama D12/110
D543,903 S * 6/2007 Kashima D12/110
D578,042 S * 10/2008 Yang D12/111
D644,961 S * 9/2011 Watanabe D12/110
D662,860 S * 7/2012 Devernay D12/110
D678,128 S * 3/2013 Lambri D12/110
D679,223 S * 4/2013 Loasby D12/110
D730,778 S * 6/2015 Harness D12/111
D730,779 S * 6/2015 Arbour D12/111

(Continued)

(73) Assignee: **BEIJING NIU INFORMATION TECHNOLOGY CO., LTD.**, Beijing (CN)

(**) Term: **15 Years**

(21) Appl. No.: **29/717,271**

(22) Filed: **Dec. 16, 2019**

(30) **Foreign Application Priority Data**

Jun. 21, 2019 (CN) 201930324066.X

(51) **LOC (13) Cl.** **12-11**

(52) **U.S. Cl.**
USPC **D12/111**

(58) **Field of Classification Search**
USPC D12/107, 110, 111, 117; D21/412, 414, D21/419, 423-428
CPC . B62K 3/00; B62K 3/005; B62K 9/00; B62K 19/00; B62K 19/02; B62K 19/04; B62K 19/06; B62K 19/16
See application file for complete search history.

(56) **References Cited**

U.S. PATENT DOCUMENTS

D253,102 S * 10/1979 Hahn D12/110
D273,100 S * 3/1984 Ziegler D12/111
D302,801 S * 8/1989 Lacroix D12/110

OTHER PUBLICATIONS

“Segway eMoped C80” Segway., posted date Sep. 10, 2019 [online], [retrieved on Mar. 10, 2021]. Retrieved from the Internet <URL: <https://store.segway.com/segway-emoped-c80>> (Year: 2019).*

(Continued)

Primary Examiner — Darlington Ly

Assistant Examiner — Nasim Abdulaziz Ali

(74) *Attorney, Agent, or Firm* — Lando & Anastasi, LLP

(57) **CLAIM**

The ornamental design for an electric bicycle, as shown and described.

DESCRIPTION

FIG. 1 is a front elevation view of an electric bicycle embodying our new design;
FIG. 2 is a rear elevation view thereof;
FIG. 3 is a left side elevation view thereof;
FIG. 4 is a right side elevation view thereof;
FIG. 5 is a top plan view thereof;
FIG. 6 is a bottom plan view thereof; and,
FIG. 7 is a front and left side perspective view thereof.
The broken lines shown in the figures depict portions of the electric bicycle that form no part of the claimed design.

1 Claim, 5 Drawing Sheets

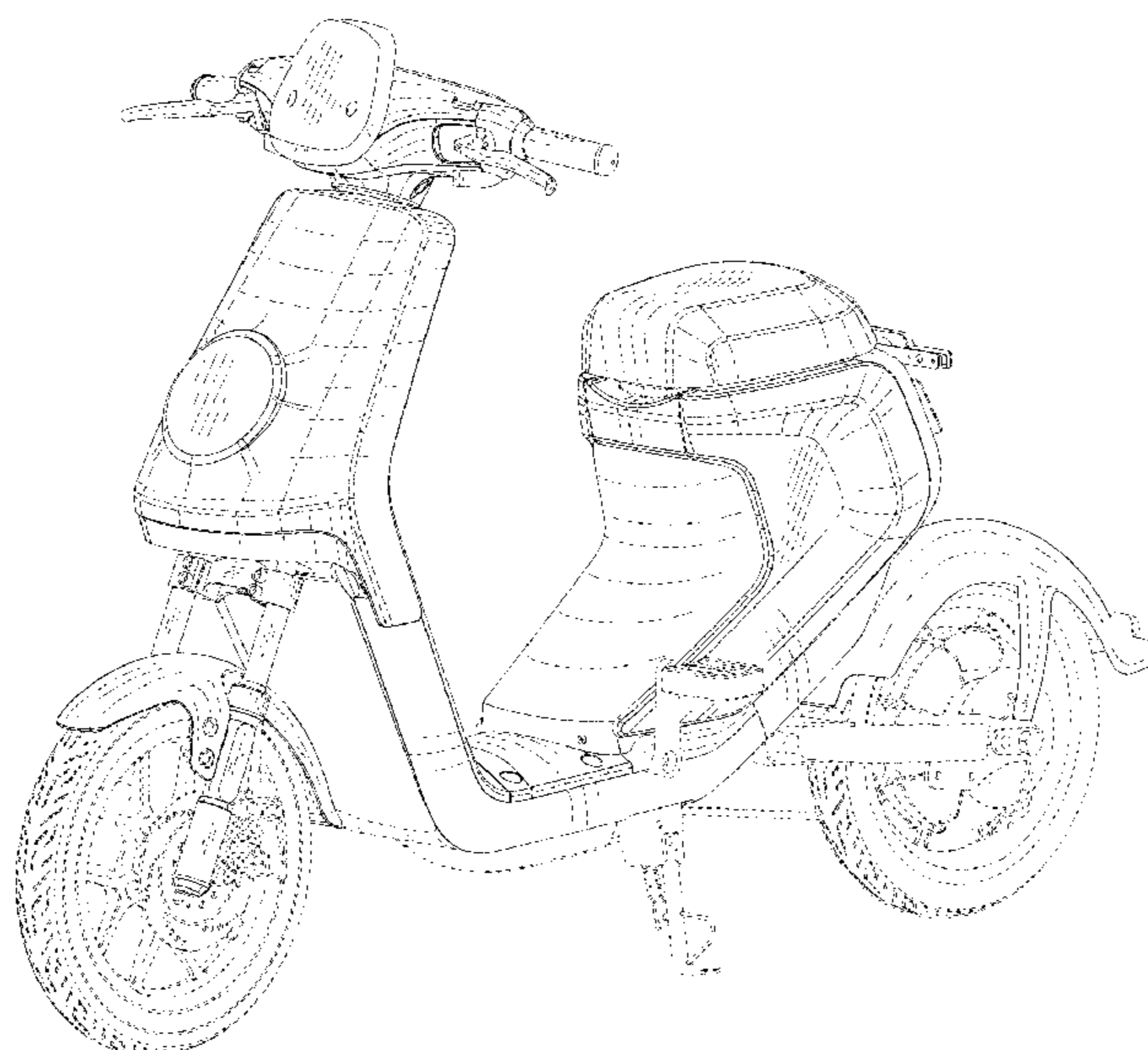

(56)

References Cited

U.S. PATENT DOCUMENTS

D742,791 S	*	11/2015	Sanderson	D12/110
D761,699 S	*	7/2016	Watanabe	D12/110
D806,610 S	*	1/2018	Su	D12/110
D838,212 S	*	1/2019	David	D12/110
D856,853 S	*	8/2019	Luke	D12/110
D874,984 S	*	2/2020	Luke	D12/110
D910,497 S	*	2/2021	Sun	D12/111

OTHER PUBLICATIONS

“NIU debuts new electric scooters” NIU., posted date Nov. 7, 2018 [online], [retrieved on Mar. 10, 2021]. Retrieved from the Internet <URL: <https://electrek.co/2018/11/07/niu-electric-scooters-umini/>> (Year: 2018).*

“Xiaomi’s Cute Electric Moped” Xiamoi., posted date Mar. 30, 2020 [online], [retrieved on Mar. 10, 2021]. Retrieved from the Internet <URL: <https://www.zigwheels.com/news-features/news/xiaomi-a1-e-bike-unveiled-in-china-cheaper-than-oneplus-7/38034/>> (Year: 2020).*

* cited by examiner

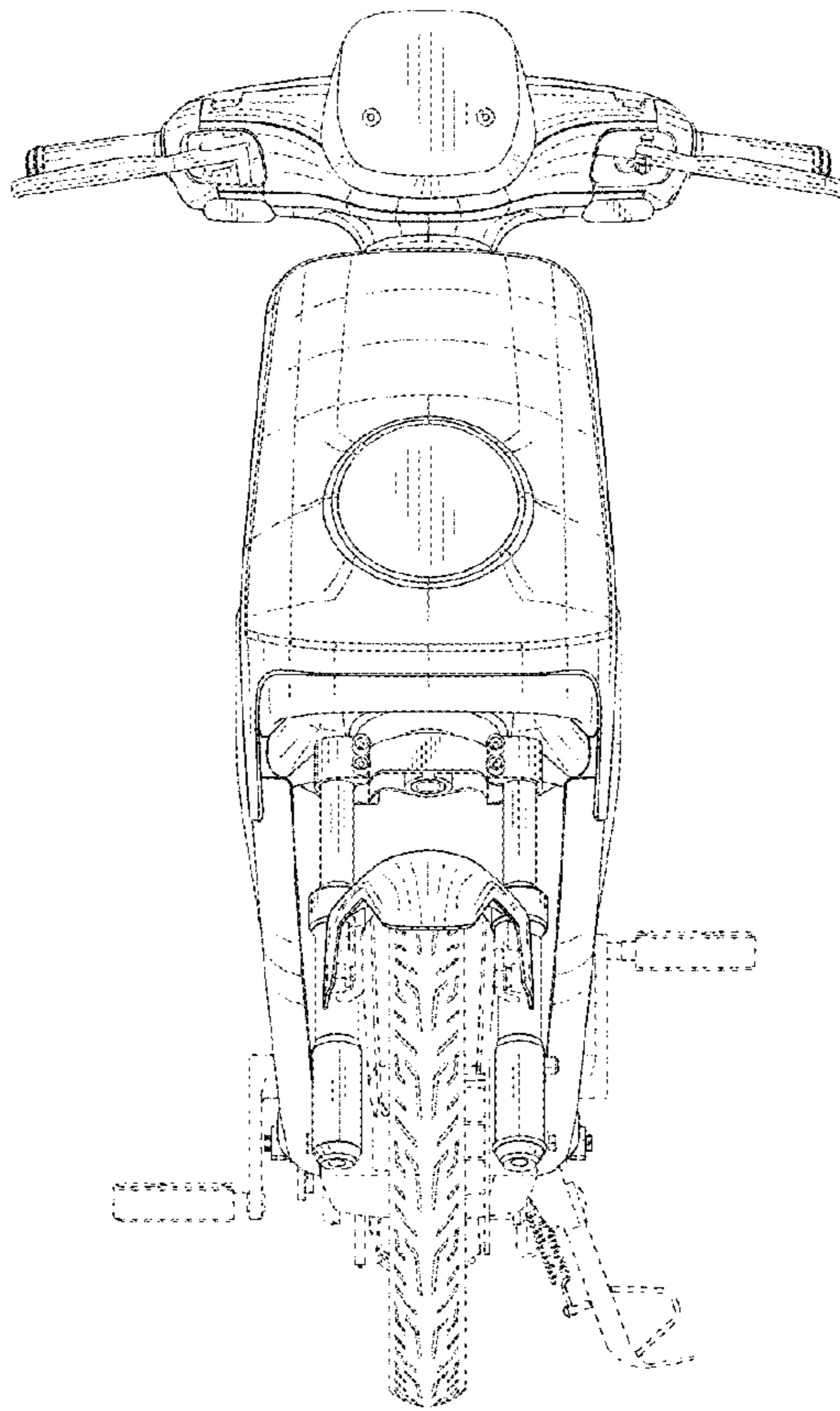

FIG.1

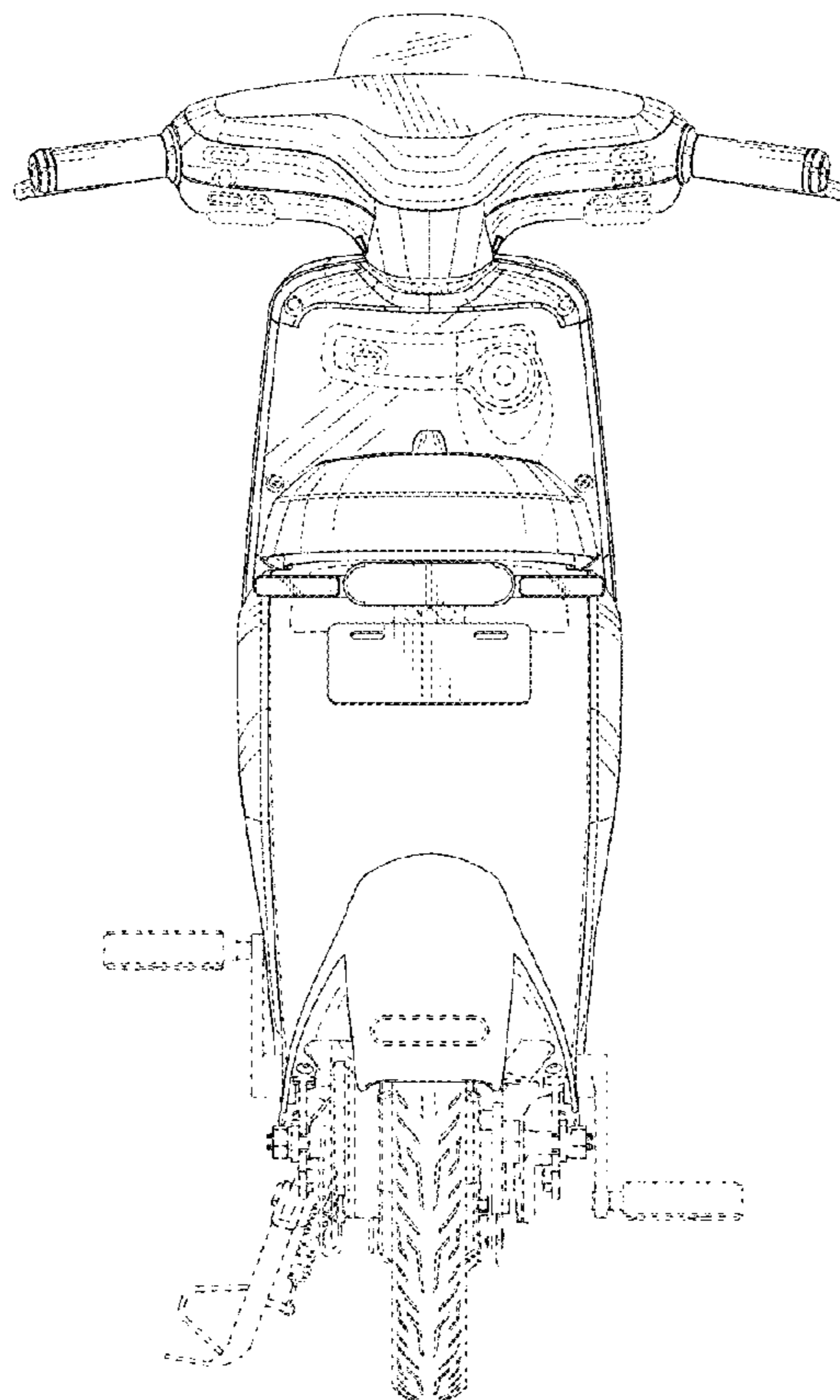

FIG.2

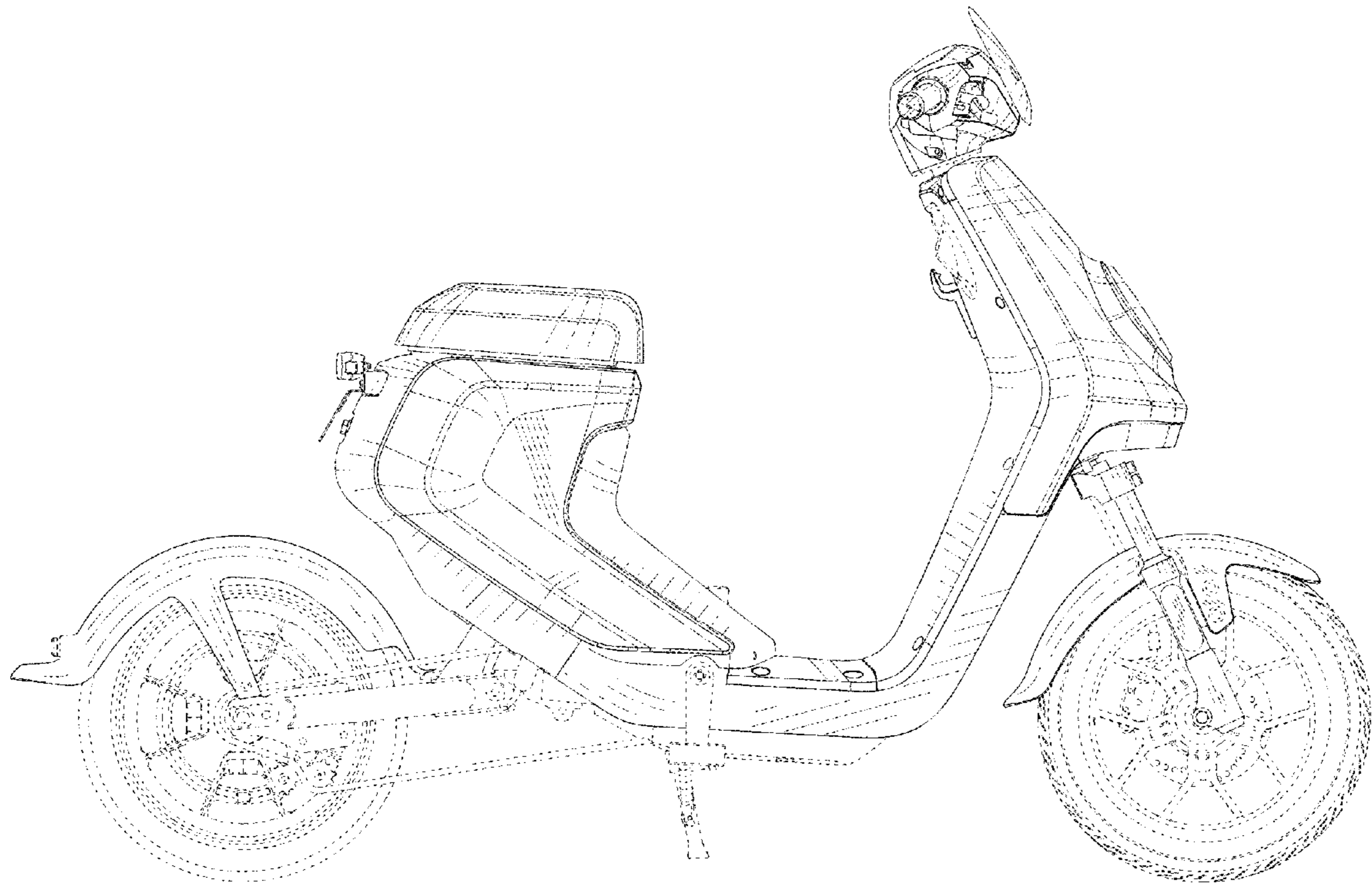

FIG.3

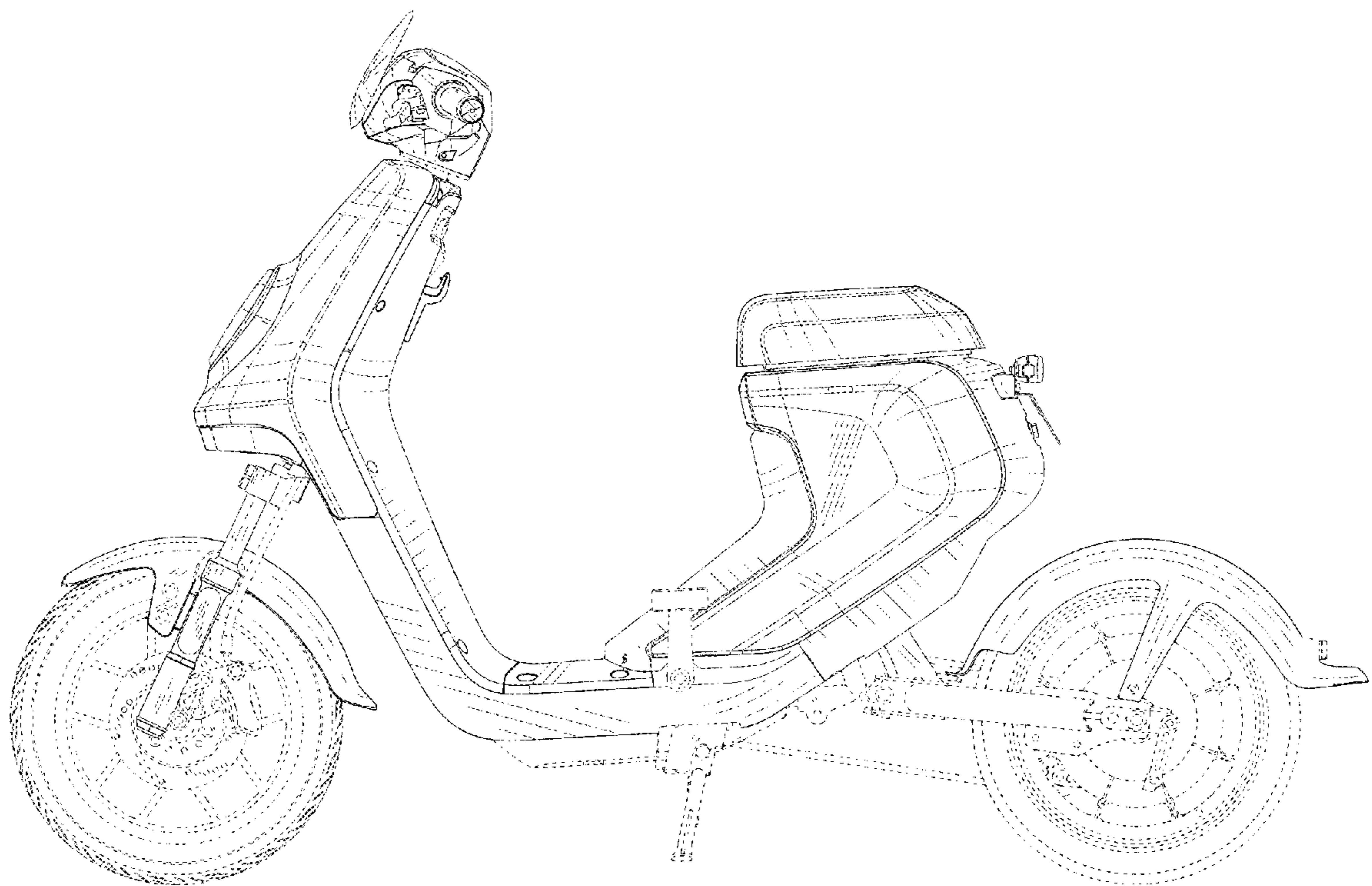

FIG.4

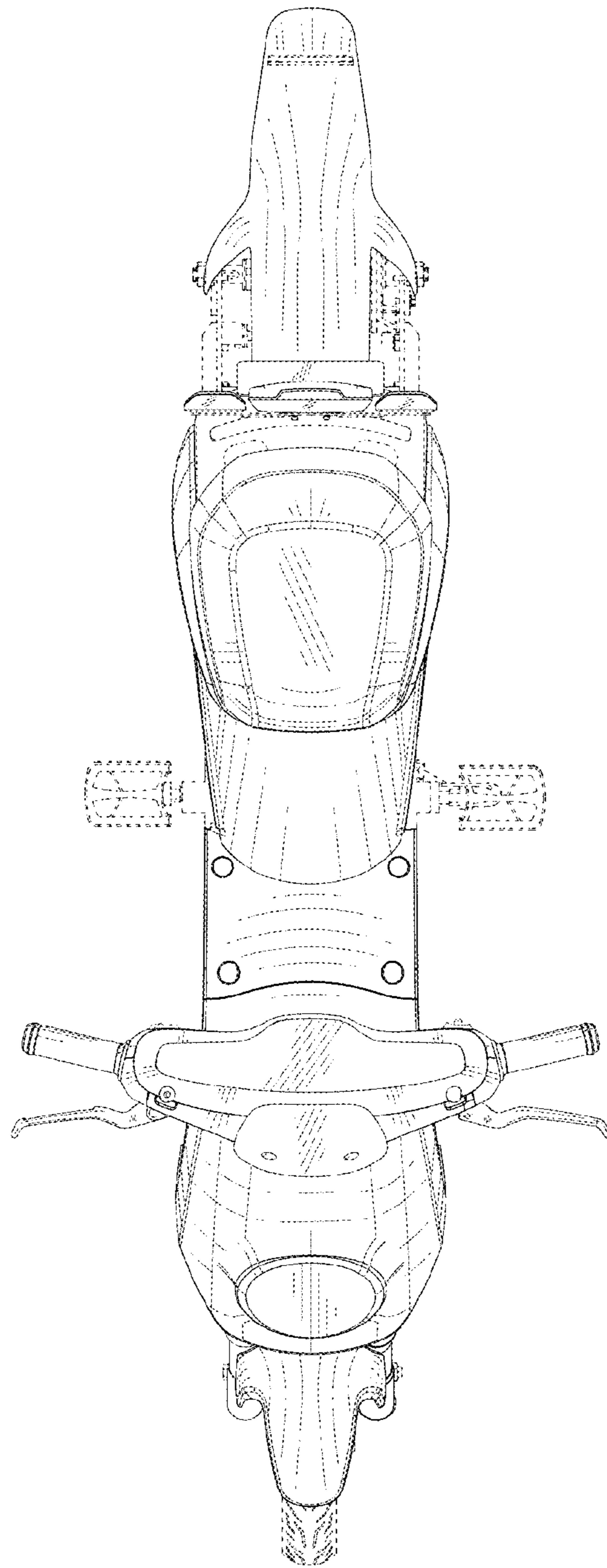

FIG.5

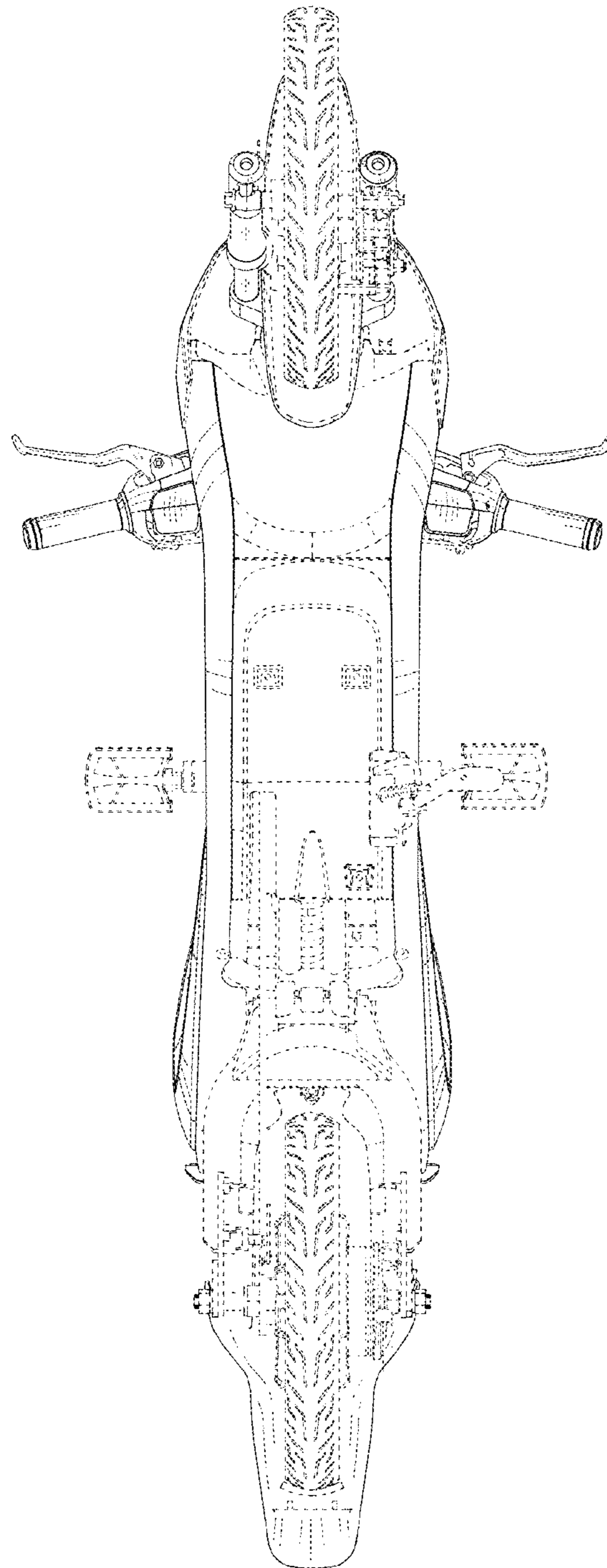

FIG.6

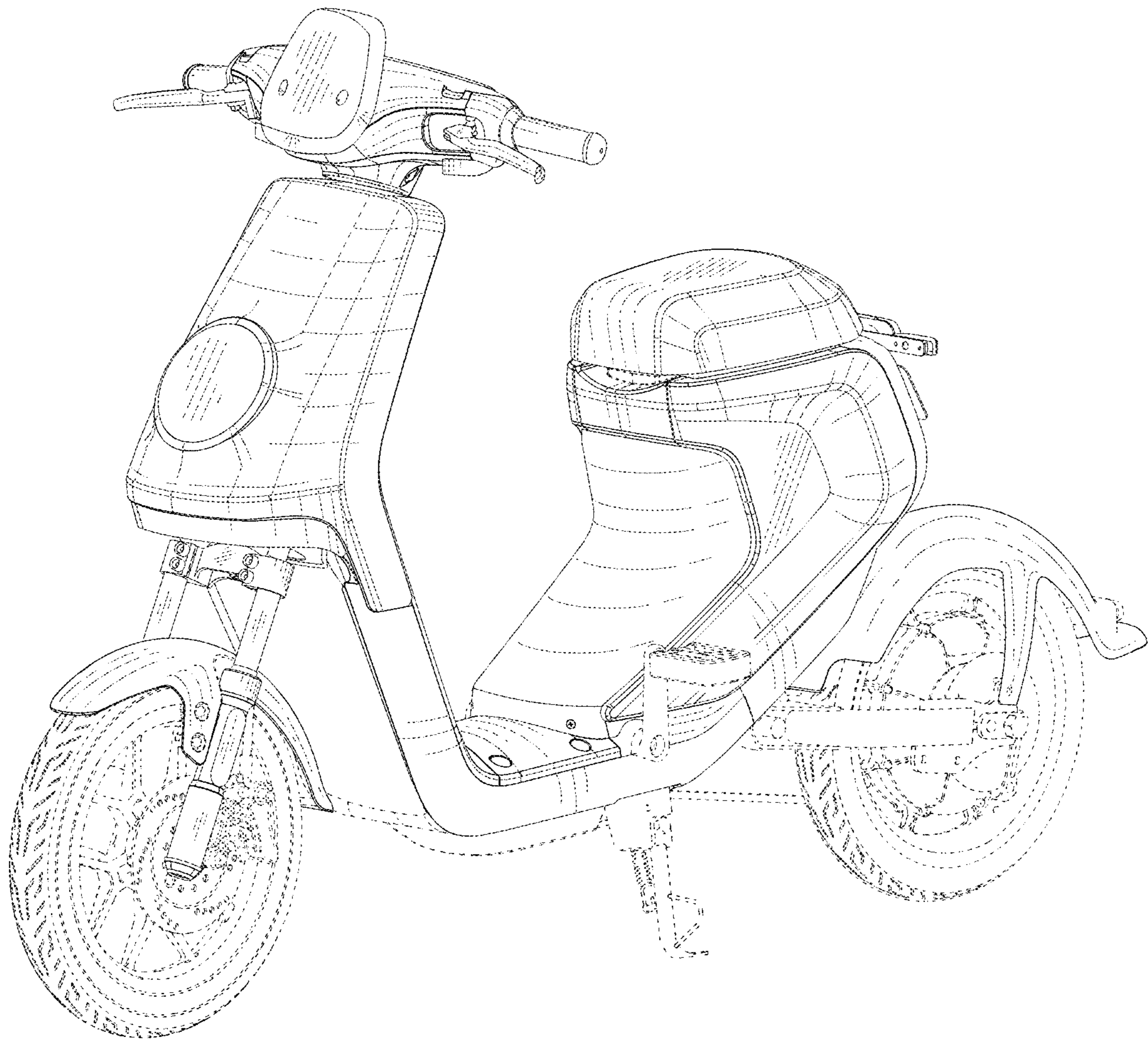

FIG. 7