



US00D947006S

(12) **United States Design Patent** (10) **Patent No.:** **US D947,006 S**  
**Cohen et al.** (45) **Date of Patent:** **\*\* Mar. 29, 2022**

(54) **ACCESSORY ATTACHMENT RACK**

OTHER PUBLICATIONS

(71) Applicant: **Santiva Outdoors, L.L.C.—Series IP**,  
Dallas, TX (US)

(72) Inventors: **William Jason Cohen**, Dallas, TX  
(US); **Tomas L. Ortiz Ferrer**, Sai  
Kung (CN); **R Barrett Kotnik**,  
Oswego, IL (US)

(\*\*) Term: **15 Years**

(21) Appl. No.: **29/772,047**

(22) Filed: **Feb. 26, 2021**

**Related U.S. Application Data**

(63) Continuation-in-part of application No. 17/072,633,  
filed on Oct. 16, 2020, which is a continuation-in-part  
of application No. 16/898,531, filed on Jun. 11, 2020,  
application No. 29/772,047, which is a  
continuation-in-part of application No. 16/798,213,  
filed on Feb. 21, 2020, now Pat. No. 11,008,030,  
application No. 29/772,047, which is a  
continuation-in-part of application No. 29/681,056,  
filed on Feb. 22, 2019, now Pat. No. Des. 916,582.

(51) **LOC (13) Cl.** ..... **08-05**

(52) **U.S. Cl.**

USPC ..... **D8/354**

(58) **Field of Classification Search**

USPC ..... D8/354

CPC ..... B60P 7/0815

See application file for complete search history.

(56) **References Cited**

**U.S. PATENT DOCUMENTS**

6,401,939 B1 \* 6/2002 Durin ..... H02G 3/0443  
211/26  
D472,058 S \* 3/2003 Weichert ..... D6/315  
D915,868 S \* 4/2021 Hien ..... D8/354

GOFR Cooler Cart, posted at gofroudoors.com, posting date not  
given, [online], [site visited Nov. 4, 2021]. Available from Internet,  
URL: <https://www.gofroudoors.com/products/gofr-cooler-cart> (Year:  
2021).\*

VonHaus Wall Mounted Pegboard and Panel Set, posted at amazon.  
com, posting date Oct. 7, 2016, [online], [site visited Nov. 4, 2021].  
Available from Internet, URL: [https://www.amazon.com/VonHaus-  
Piece-Mounted-Pegboard-Storage/dp/B01M6YZTP7](https://www.amazon.com/VonHaus-Piece-Mounted-Pegboard-Storage/dp/B01M6YZTP7) (Year: 2021).\*

\* cited by examiner

*Primary Examiner* — Michael C Stout

*Assistant Examiner* — Maria J. Edwards

(74) *Attorney, Agent, or Firm* — Jason H. Rosenblum;  
Law Office of Jason H. Rosenblum, PLLC

(57) **CLAIM**

The ornamental design for an accessory attachment rack, as  
shown and described.

**DESCRIPTION**

FIG. 1 is a front perspective view of an accessory attachment  
rack showing our new design;  
FIG. 2 is a front view thereof;  
FIG. 3 is a rear view thereof;  
FIG. 4 is a side view thereof;  
FIG. 5 is a side view thereof;  
FIG. 6 is a top perspective view thereof;  
FIG. 7 is a bottom view thereof; and,  
FIG. 8 is a top view thereof.

The broken lines illustrate environmental subject matter  
only and form no part of the claimed design.

**1 Claim, 8 Drawing Sheets**

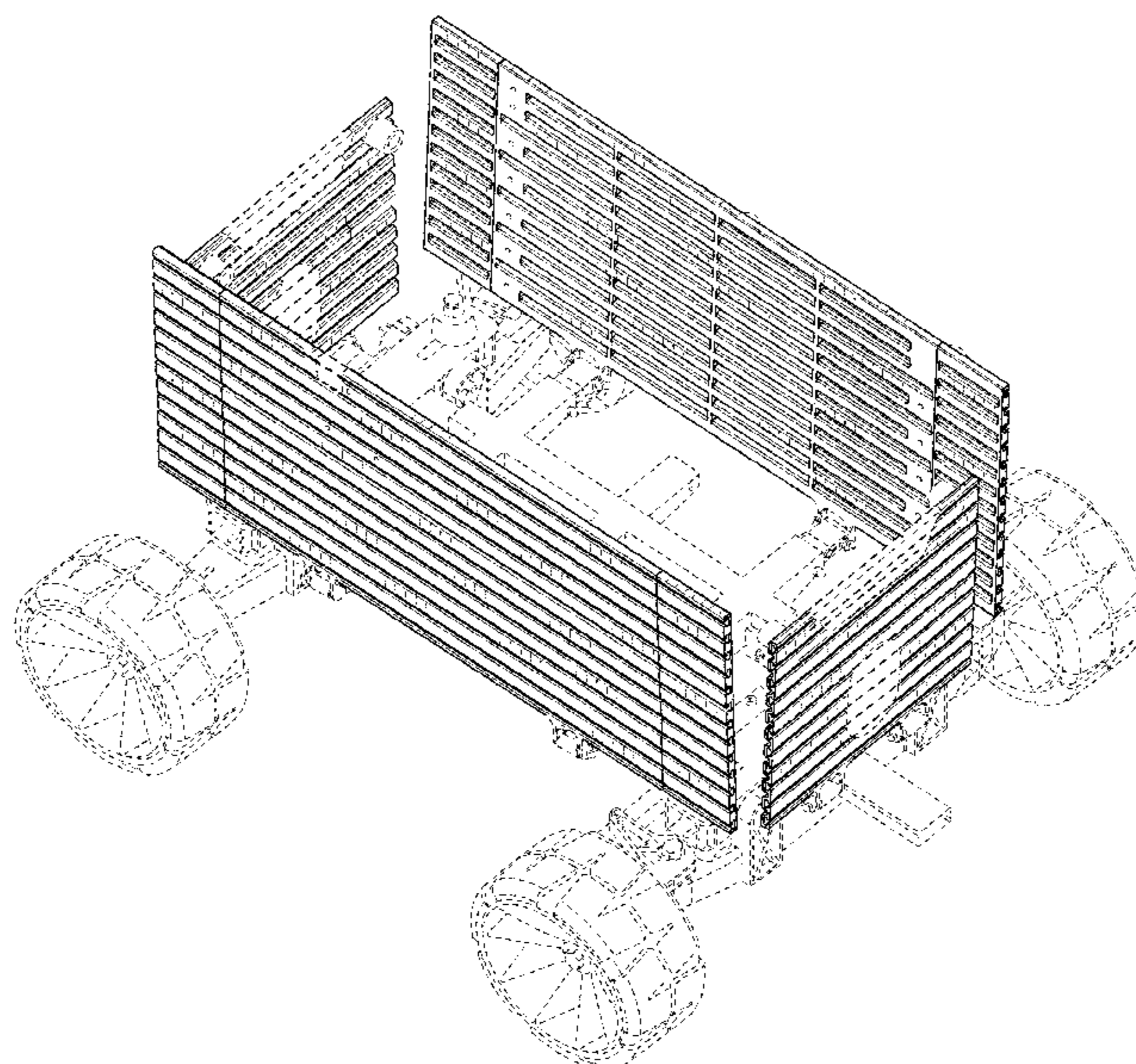

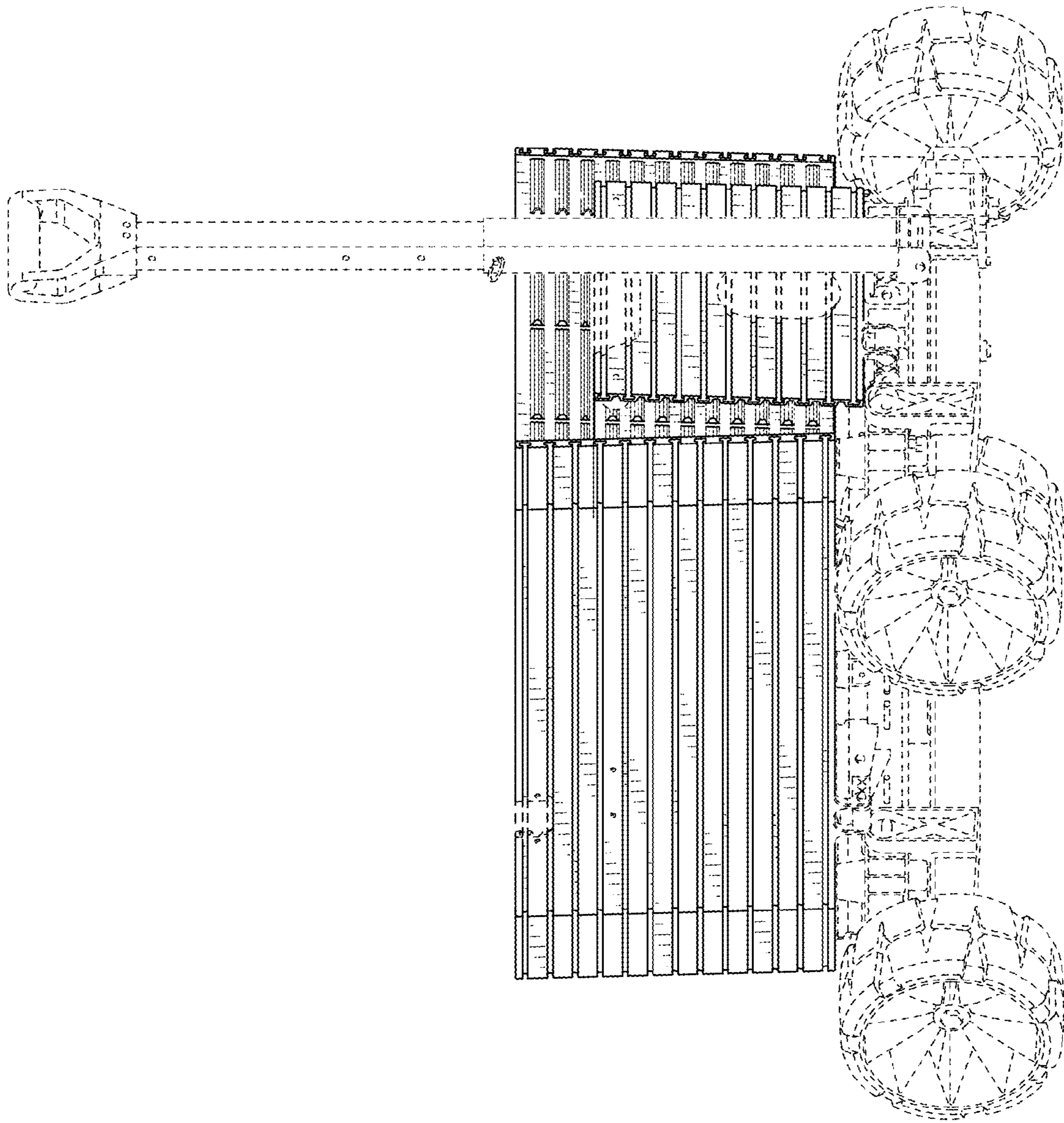

FIG. 1

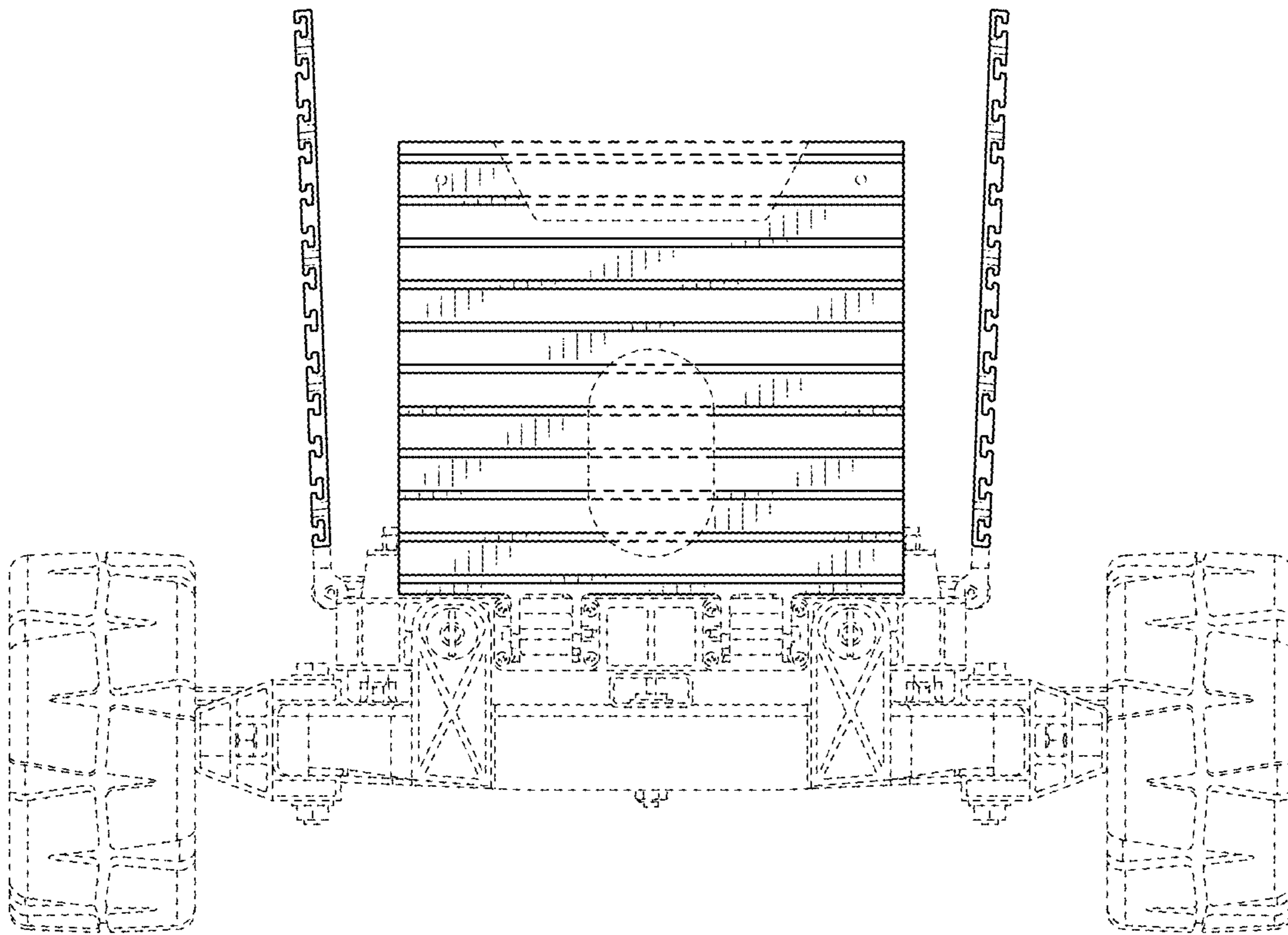

FIG. 2



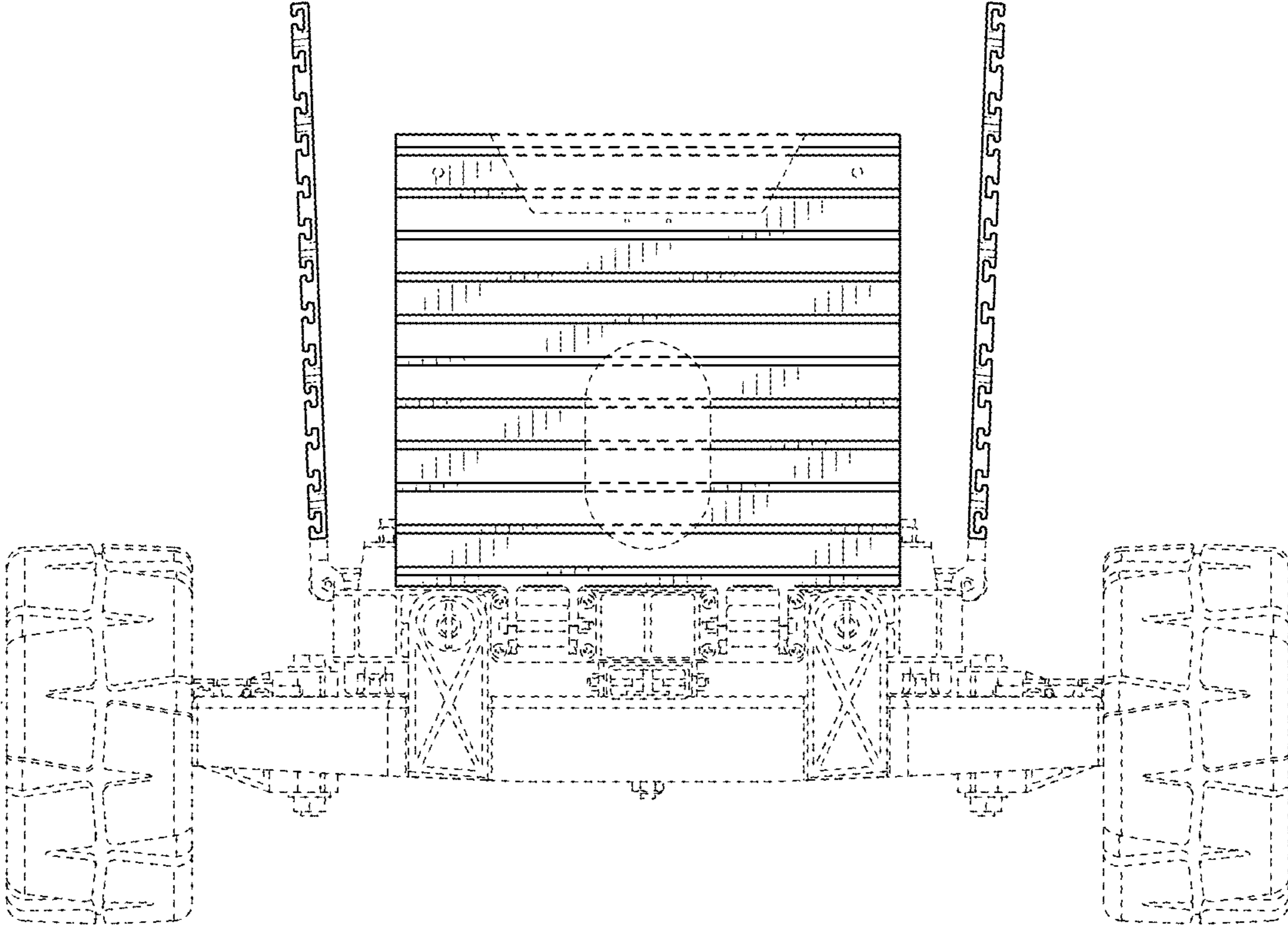

FIG. 3

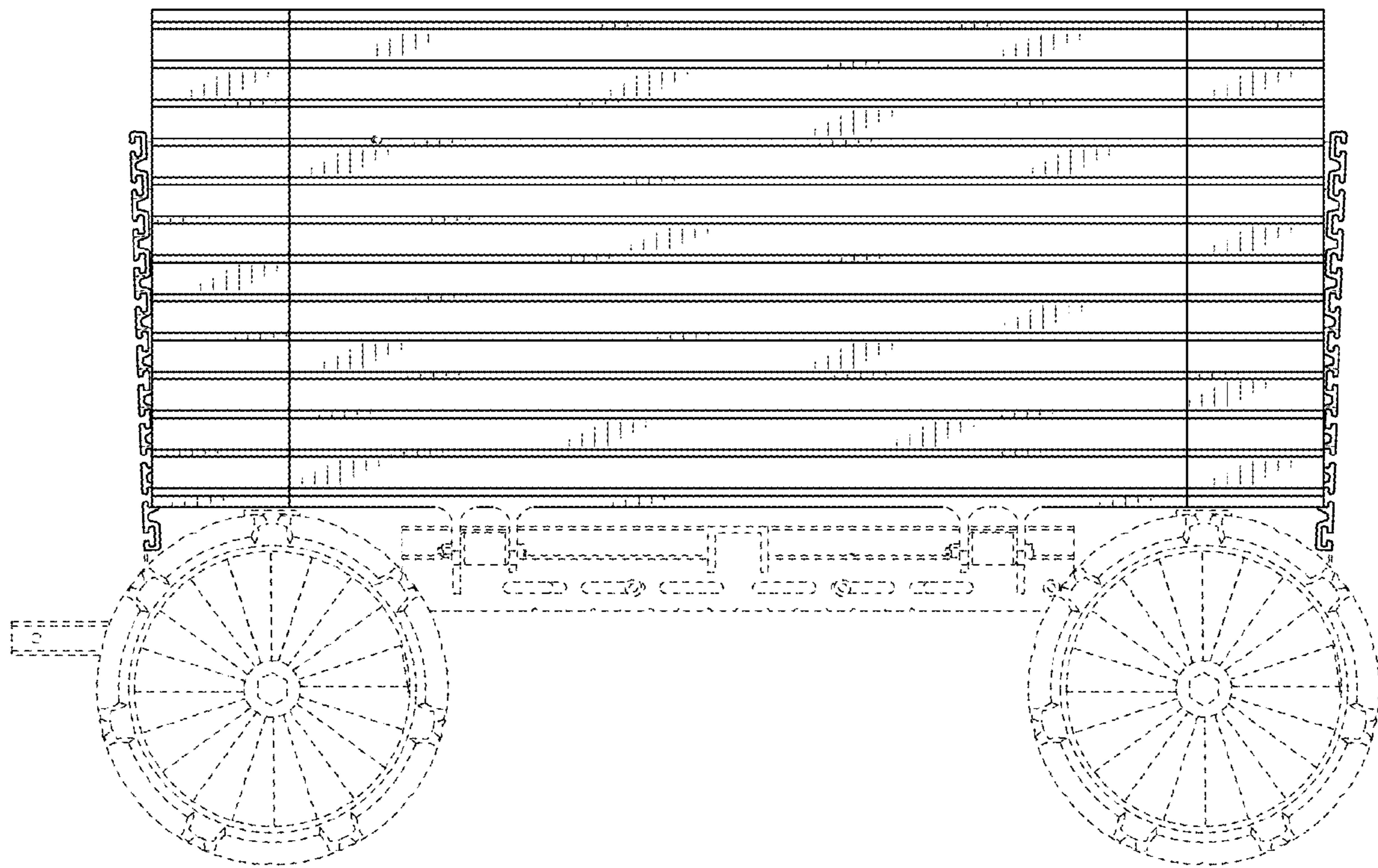

FIG. 4

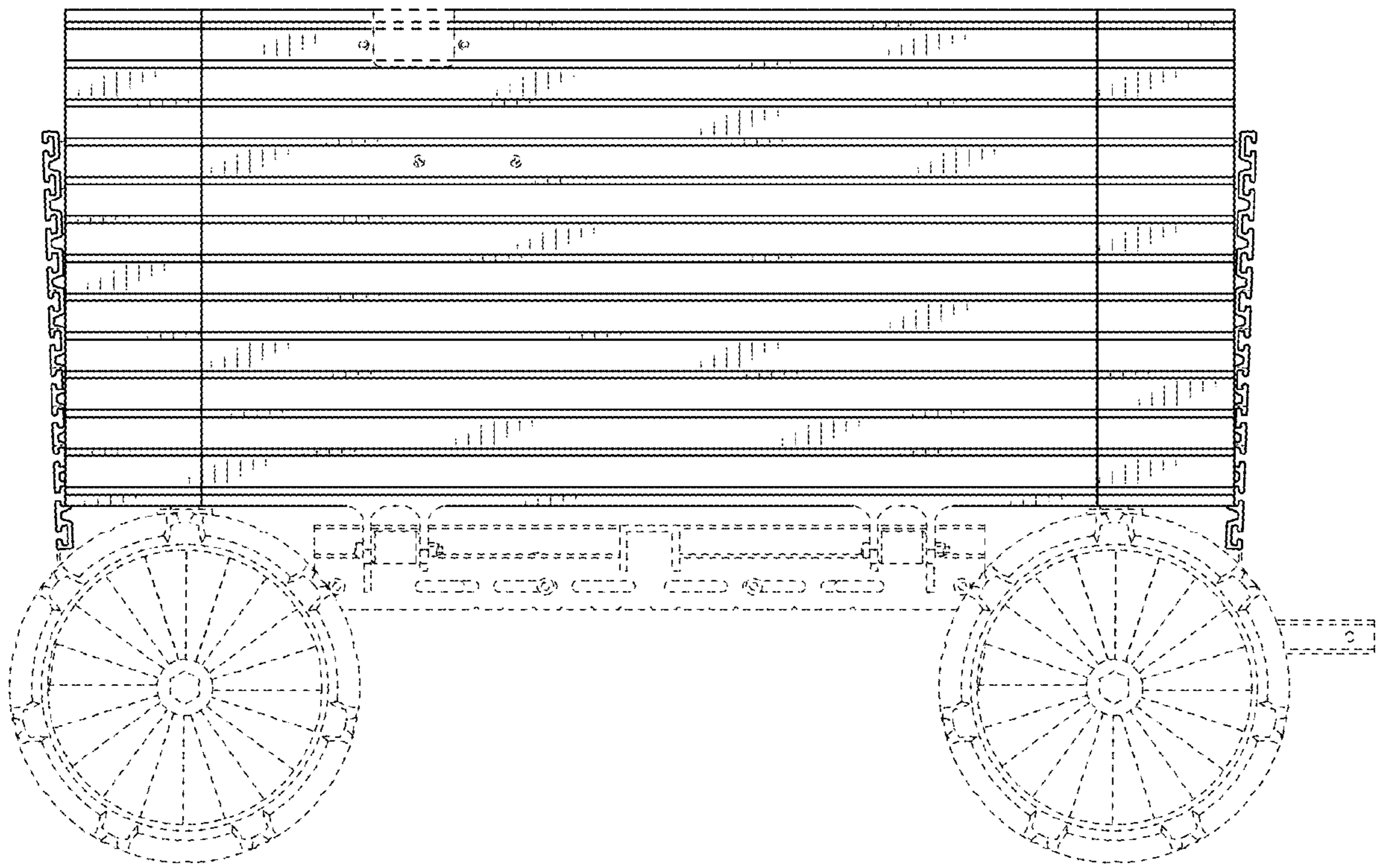

FIG. 5



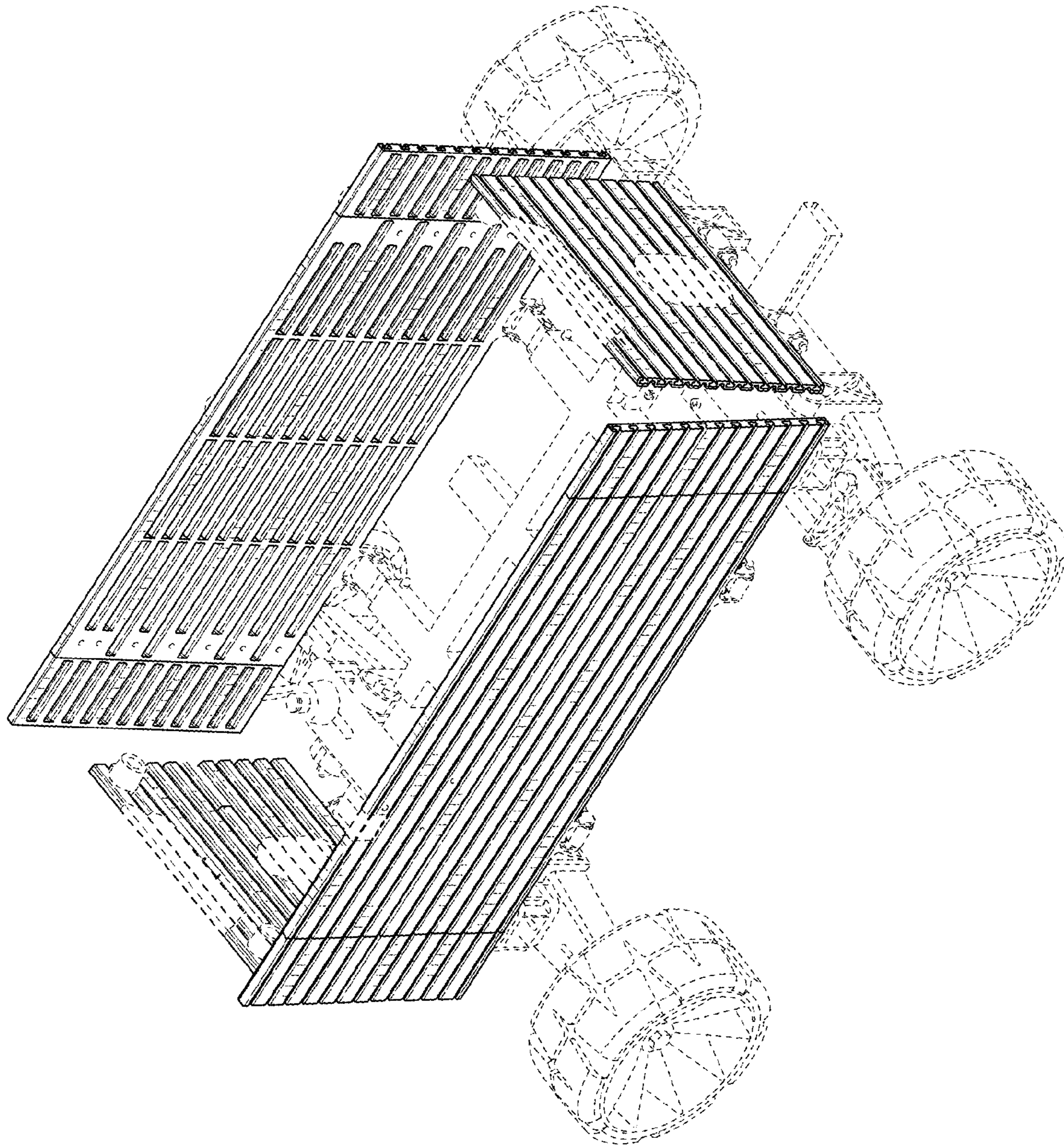

FIG. 6

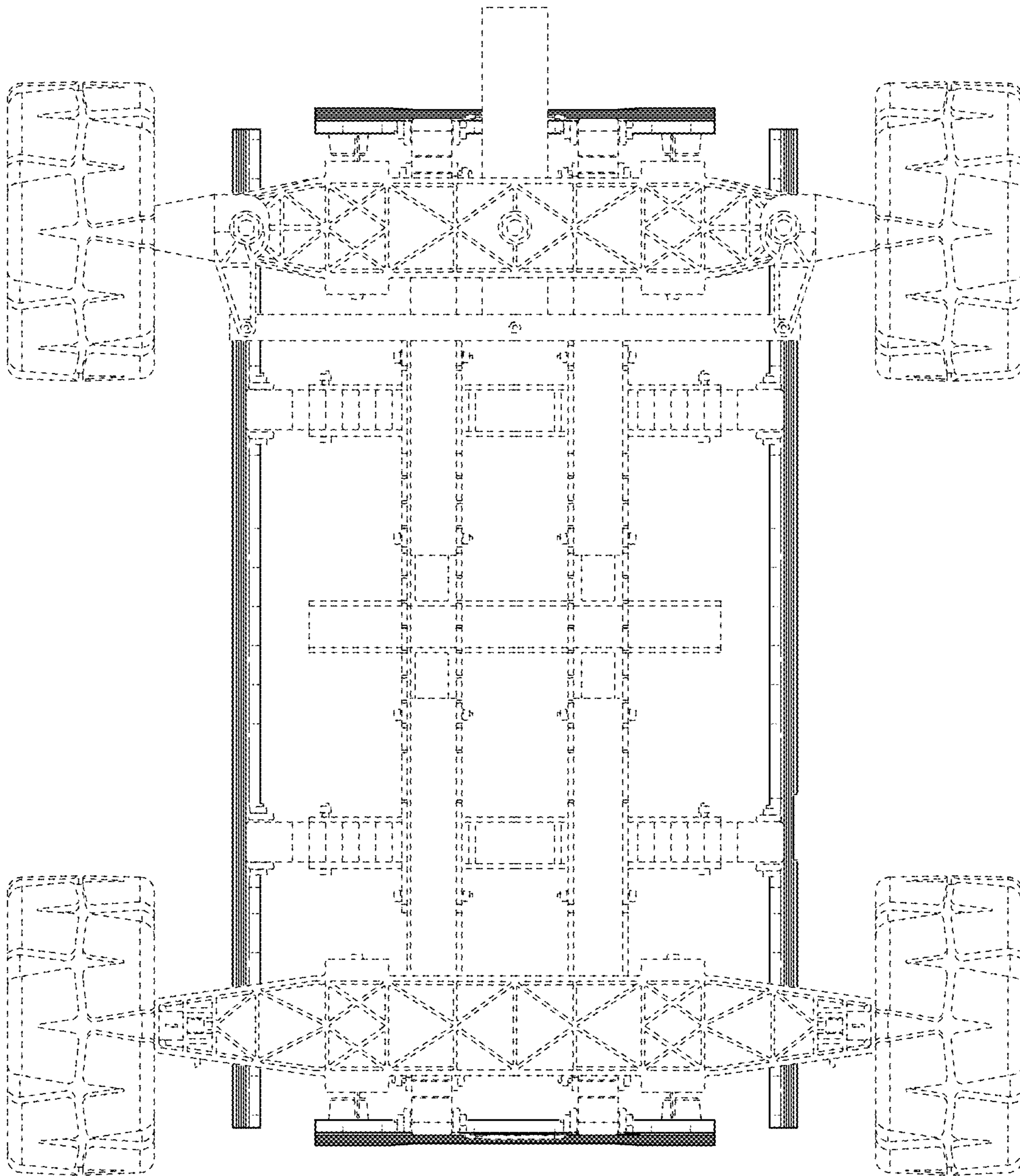

FIG. 7



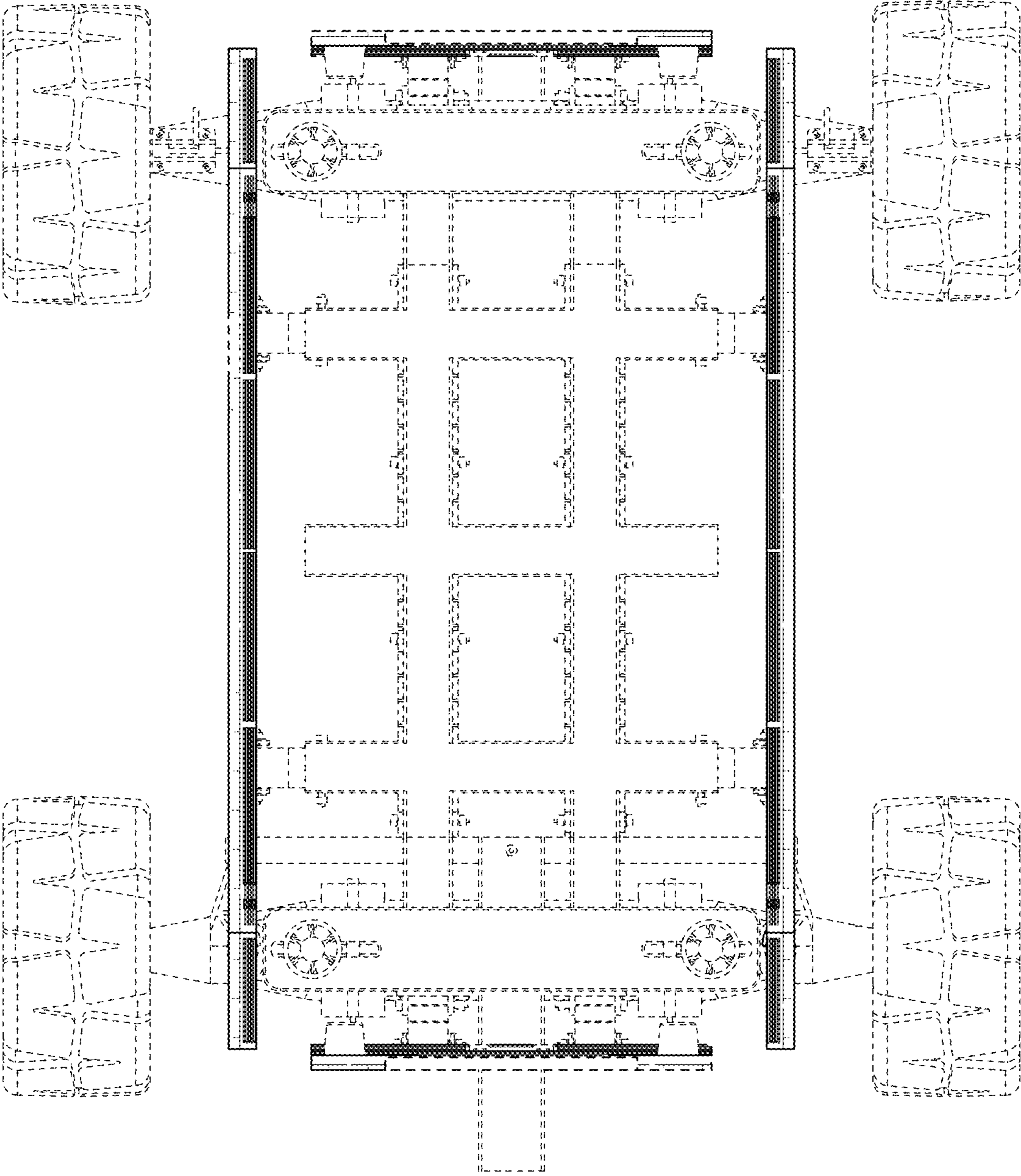

FIG. 8