



US00D946814S

(12) **United States Design Patent**  
**Liu**

(10) **Patent No.:** **US D946,814 S**  
(45) **Date of Patent:** **\*\* Mar. 22, 2022**

(54) **LIGHT**

(71) Applicant: **Feng Liu**, Changsha (CN)

(72) Inventor: **Feng Liu**, Changsha (CN)

(\*\*) Term: **15 Years**

(21) Appl. No.: **29/775,295**

(22) Filed: **Mar. 23, 2021**

(51) **LOC (13) Cl.** ..... **26-05**

(52) **U.S. Cl.**

USPC ..... **D26/110**

(58) **Field of Classification Search**

USPC ..... D9/516, 519, 537, 538, 539, 541, 542,  
D9/549, 558; D26/26, 37, 46, 48, 50, 61,  
D26/62, 63, 64, 93, 94, 104, 106, 110  
CPC .... F21S 6/00; F21S 6/002; F21S 6/004; F21S  
8/035; F21S 9/00; F21S 9/02; F21W  
2121/008

See application file for complete search history.

(56) **References Cited**

**U.S. PATENT DOCUMENTS**

3,393,310	A *	7/1968	Ream	.....	F21S 8/035 40/441
4,029,954	A *	6/1977	Moyer	.....	F21L 4/085 362/183
D254,155	S *	2/1980	Allen	.....	D26/104
D298,573	S *	11/1988	Komamura	.....	D26/37
D411,322	S *	6/1999	Suzuki	.....	D26/37
D462,475	S *	9/2002	Wu	.....	D26/104
D478,681	S *	8/2003	Newcomb	.....	D26/94
D525,740	S *	7/2006	Parker	.....	D26/104
D563,593	S *	3/2008	Audrito	.....	D26/104
D788,586	S *	6/2017	Molinari	.....	H05B 47/10 D9/504
D806,933	S	1/2018	Hui		

D815,335 S \* 4/2018 Lin ..... F21S 8/035  
D26/110

D865,231 S 10/2019 Tang  
2008/0224637 A1\* 9/2008 Parker ..... H05B 47/10  
315/309

(Continued)

**FOREIGN PATENT DOCUMENTS**

CN 201130482498 \* 6/2012  
CN 201830343552 \* 11/2018

**OTHER PUBLICATIONS**

Amazon, "Mr.Go 11" Egg Shaped Magic Color LED Mood Lamp Night Light", first available Apr. 26, 2016. (<https://www.amazon.com/Mr-Go-Dimmable-Decorative-Waterproof-Rechargeable/dp/B01ESILSYG>) (Year: 2016).\*

(Continued)

*Primary Examiner* — Lauren D McVey  
*Assistant Examiner* — Justin A Johnson

(57) **CLAIM**

The ornamental design for a light, as shown and described.

**DESCRIPTION**

FIG. 1 is a perspective view of a light showing my new design;

FIG. 2 is another perspective view thereof;

FIG. 3 is a front elevational view thereof;

FIG. 4 is a rear elevational view thereof;

FIG. 5 is a left side elevational view thereof;

FIG. 6 is a right side elevational view thereof;

FIG. 7 is a top plan view thereof;

FIG. 8 is a bottom plan view thereof; and,

FIG. 9 is an exploded perspective view of the light.

The broken lines in FIGS. 2 and 8 of the drawings depict portions of the light that form no part of the claimed design.

The broken lines in FIG. 9 of the drawings depict environment of the light that form no part of the claimed design.

**1 Claim, 9 Drawing Sheets**

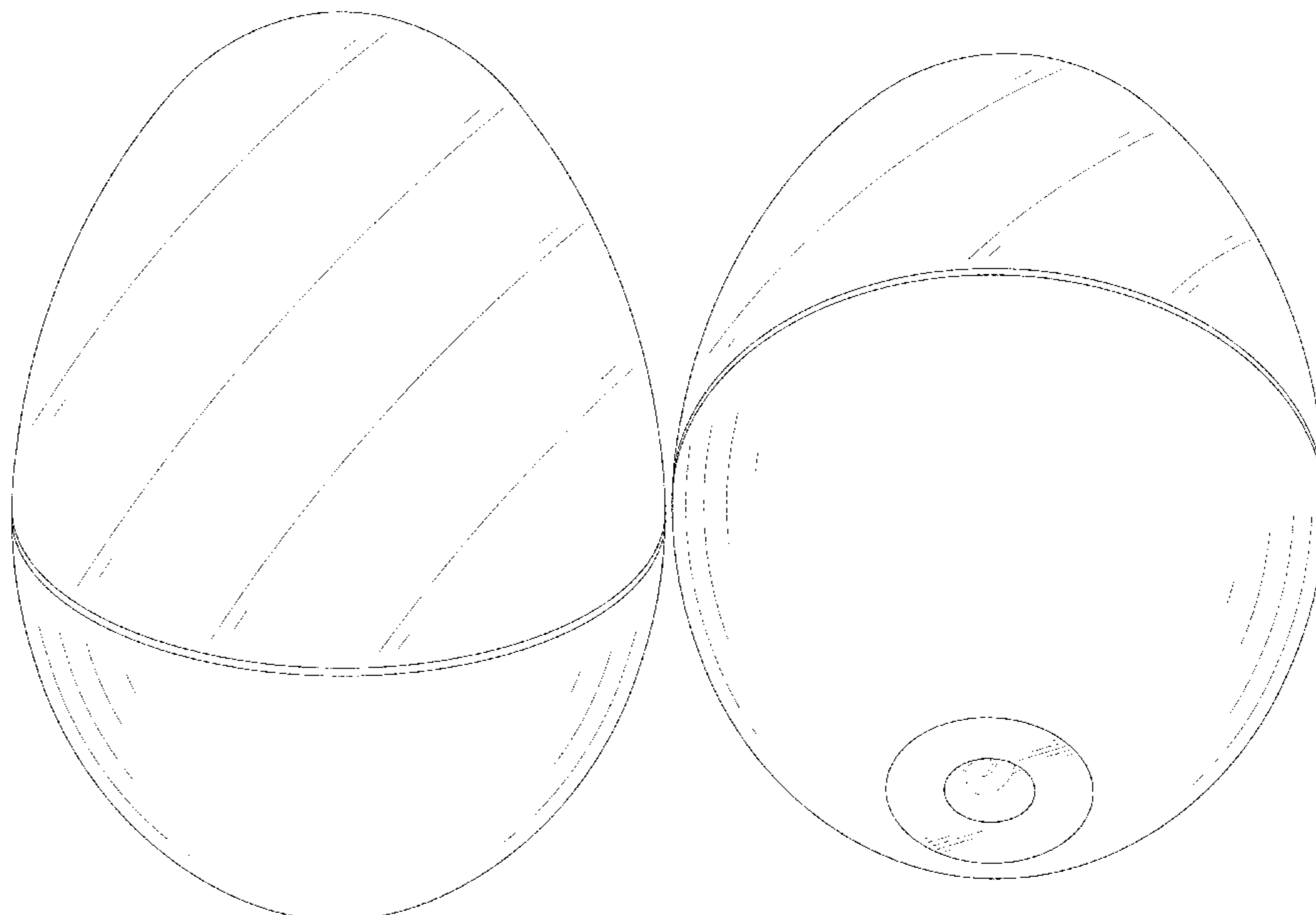

(56)

**References Cited**

U.S. PATENT DOCUMENTS

2020/0370716 A1\* 11/2020 Bihong ..... F21V 3/02

OTHER PUBLICATIONS

Amazon, "Upcycle Egg Drop Faux-Wood Levitating Bluetooth Speaker", first available Nov. 2, 2018. (<https://www.amazon.com/Upcycle-Wooden-Levitating-Bluetooth-Speaker/dp/B07K53P7W5>) (Year: 2018).\*

Amazon, "JolyWell Night Lights for Kids", first available Jun. 25, 2021. (<https://www.amazon.com/dp/B097YK4VT5/>) (Year: 2021).\*

Amazon, "Tea Light Candles, 12 Pcs Image LED Egg Shaped Lights", first available Jun. 17, 2021. (<https://www.amazon.com/dp/B097D5FTY2/>) (Year: 2021).\*

\* cited by examiner

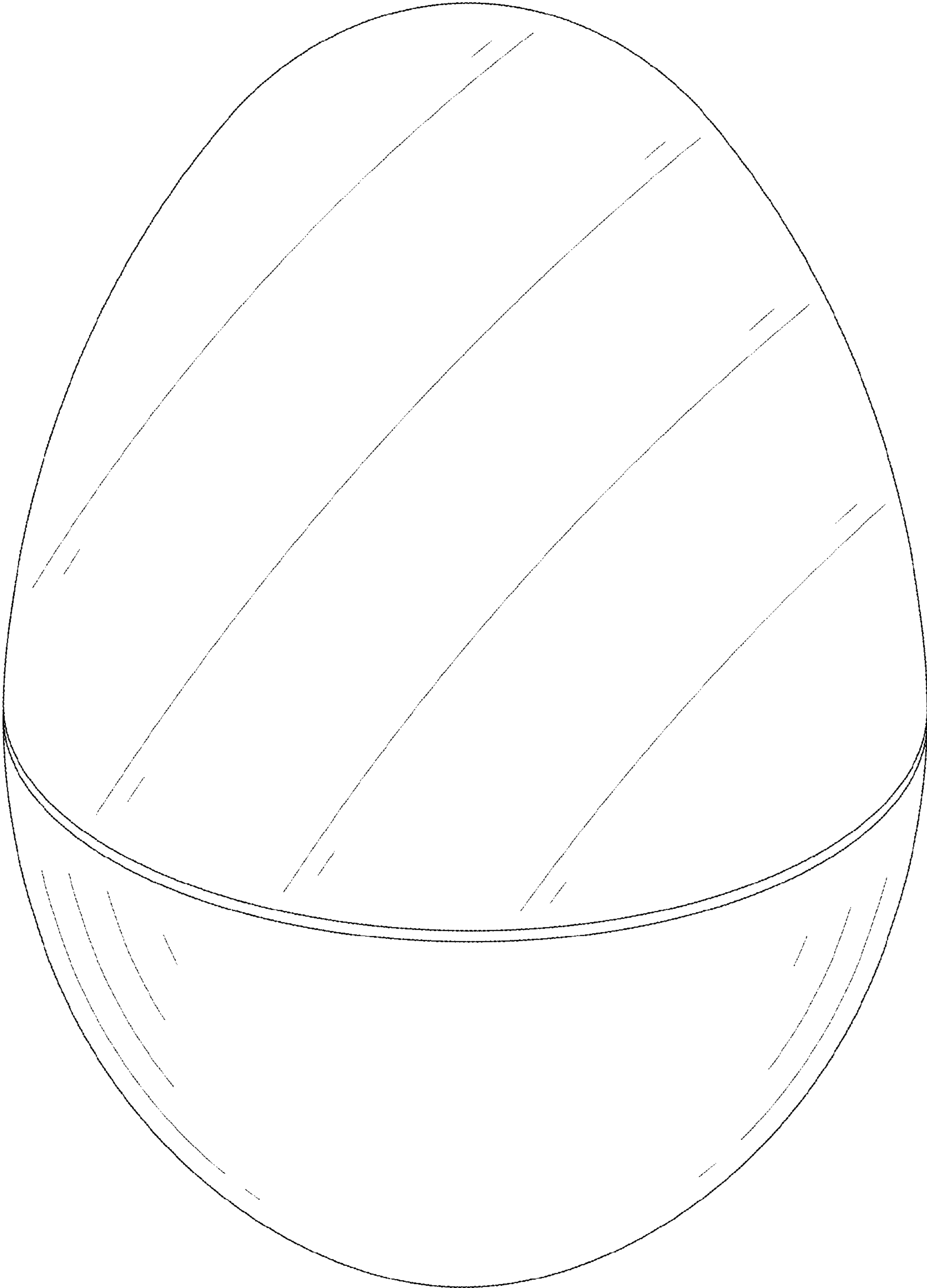

FIG. 1

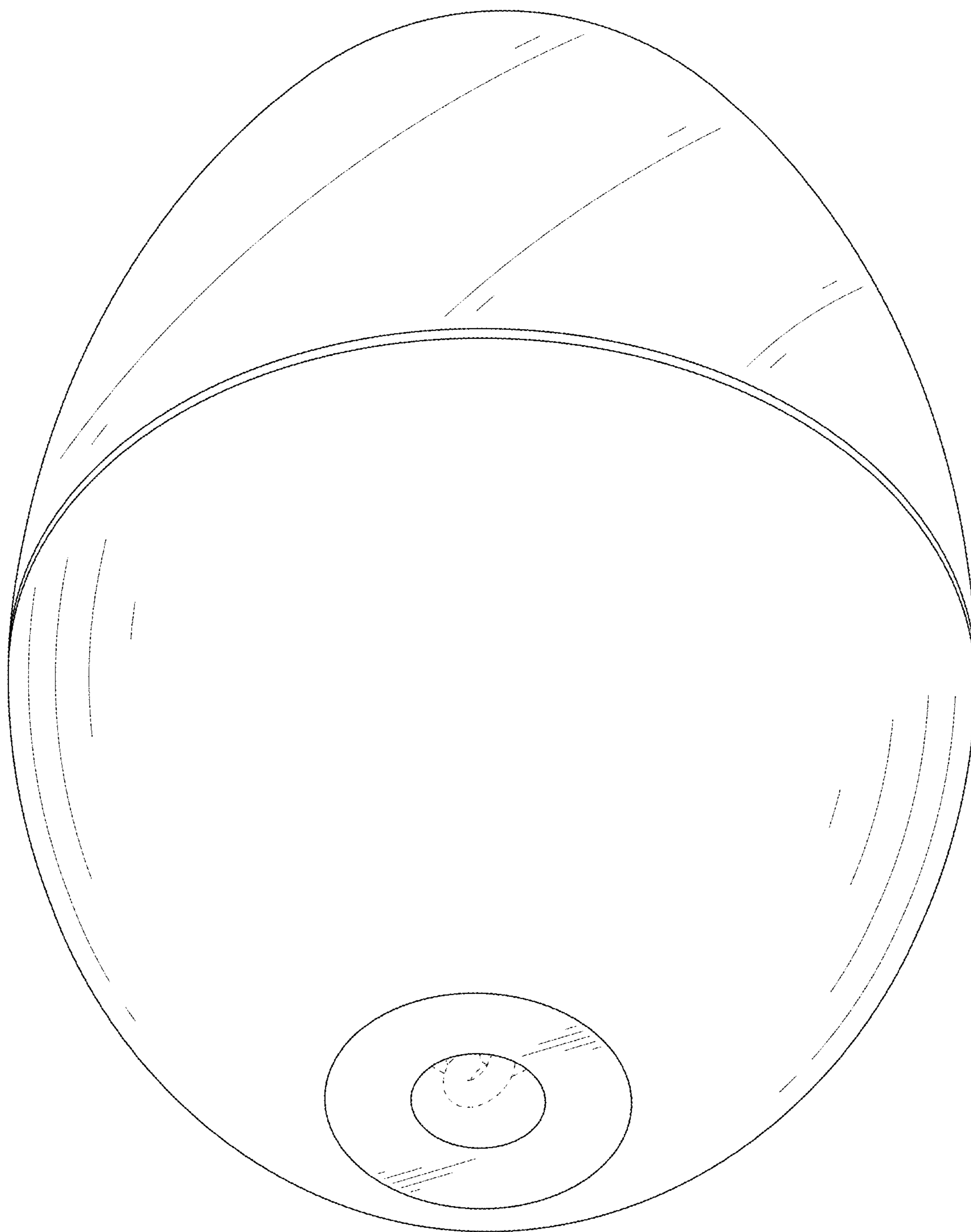

FIG. 2

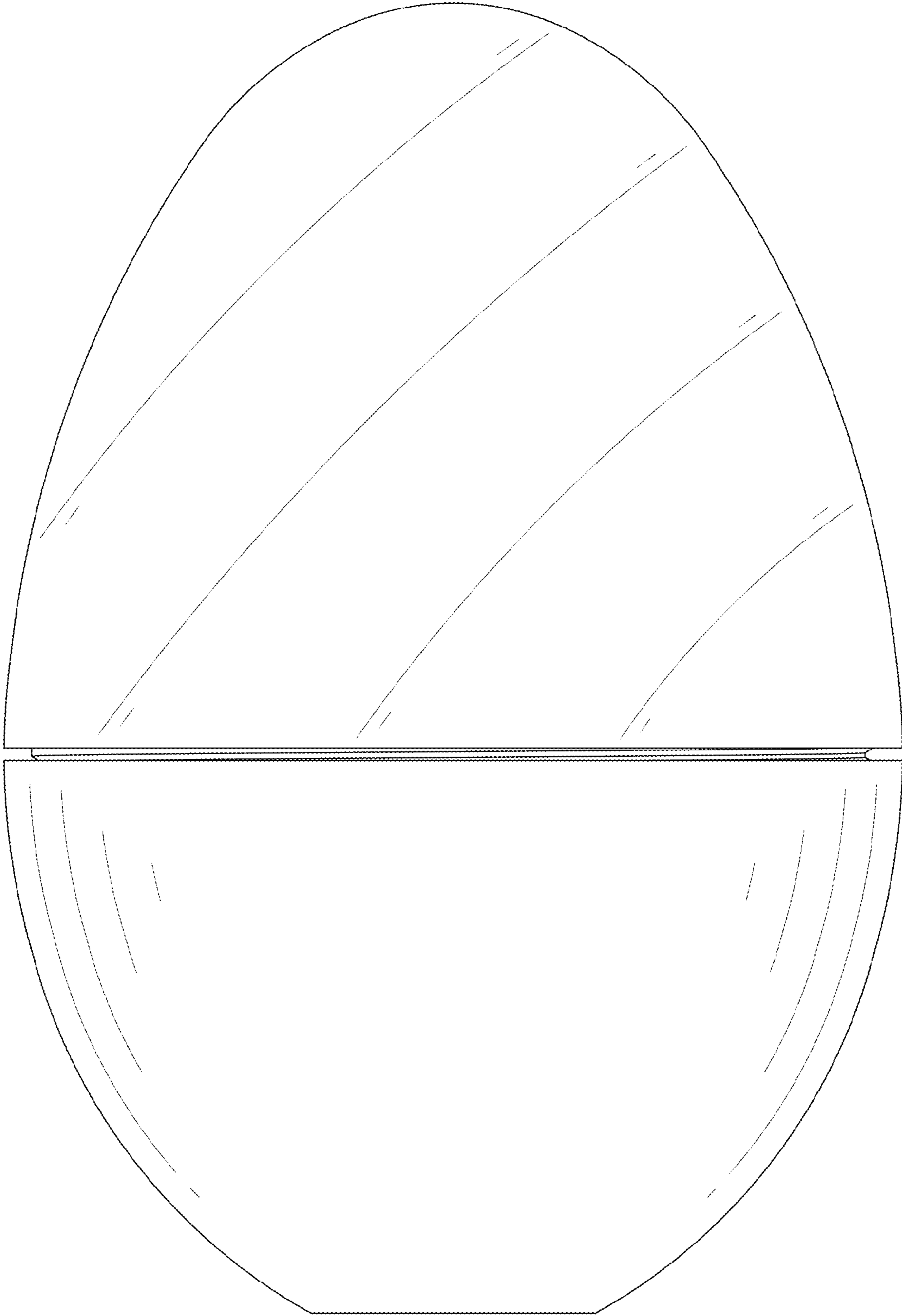

FIG. 3

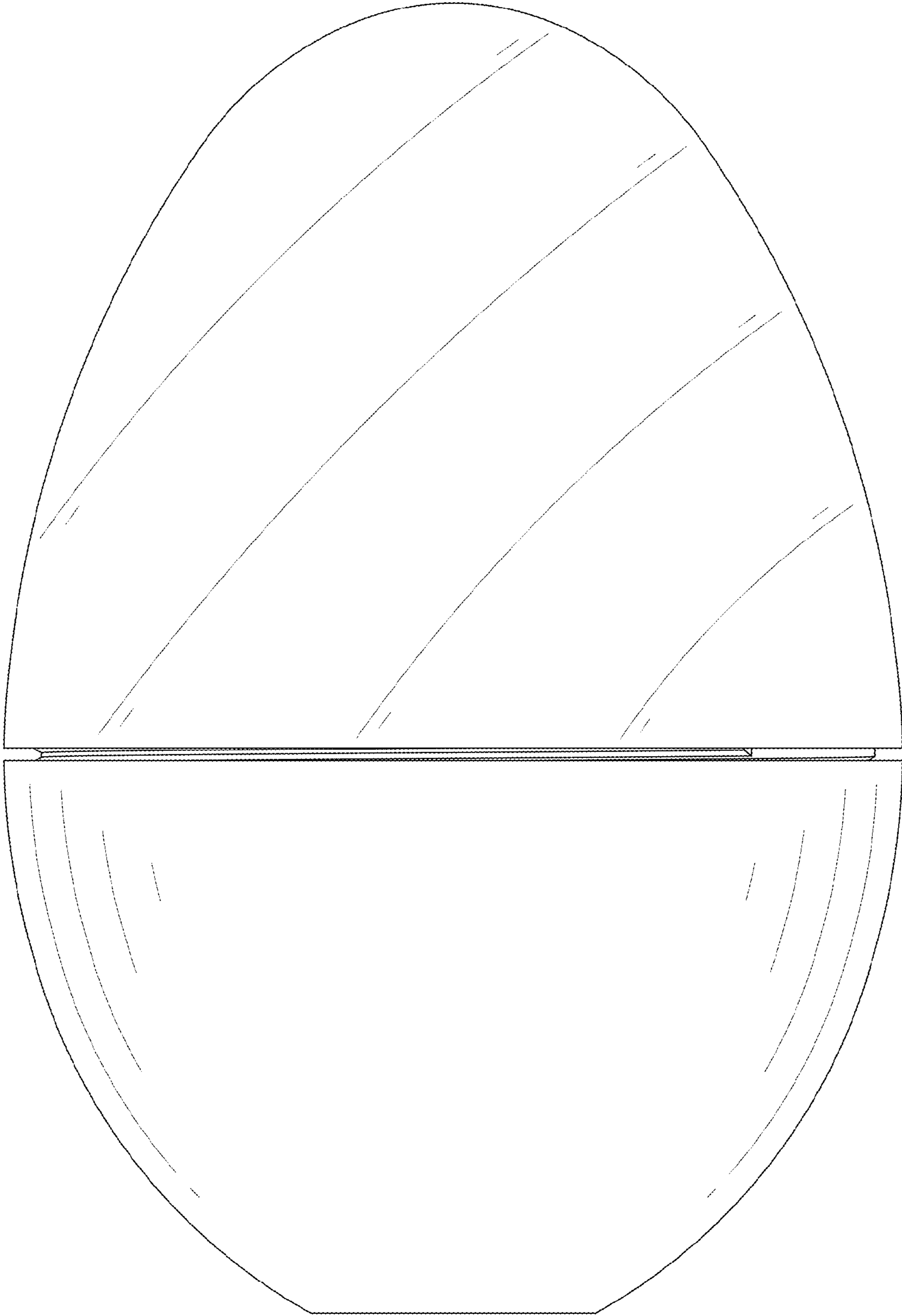

FIG. 4

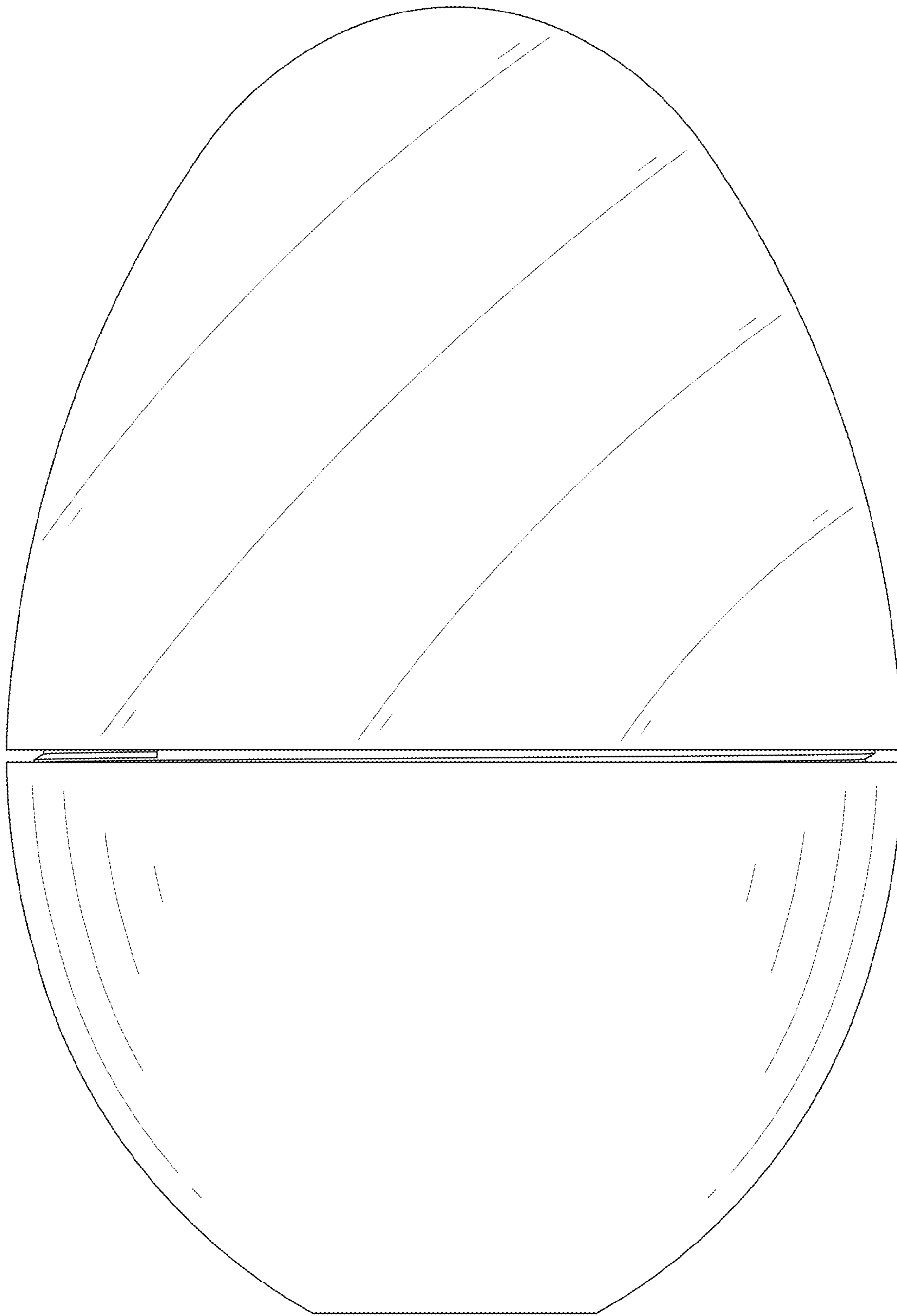

FIG. 5

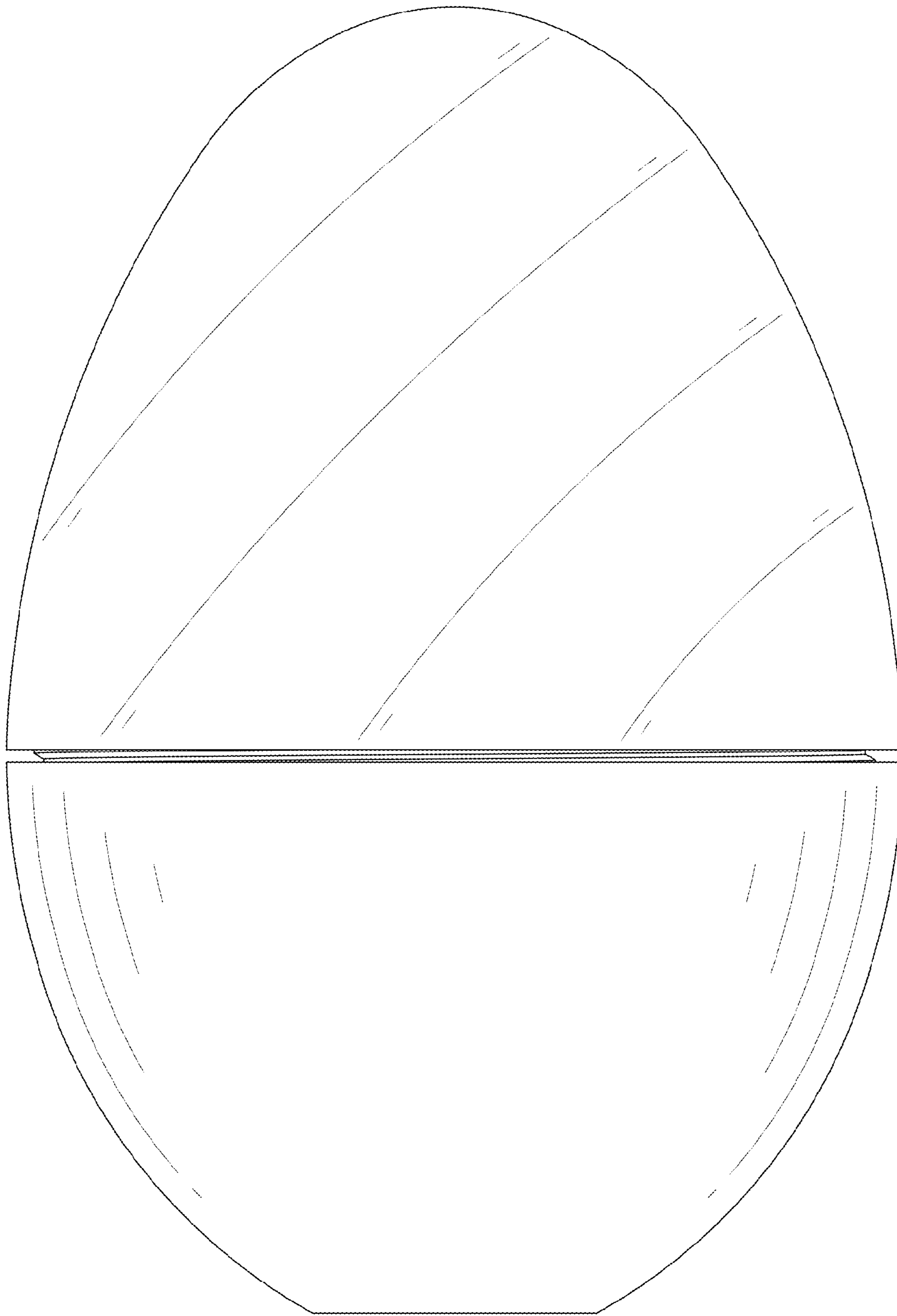

FIG. 6



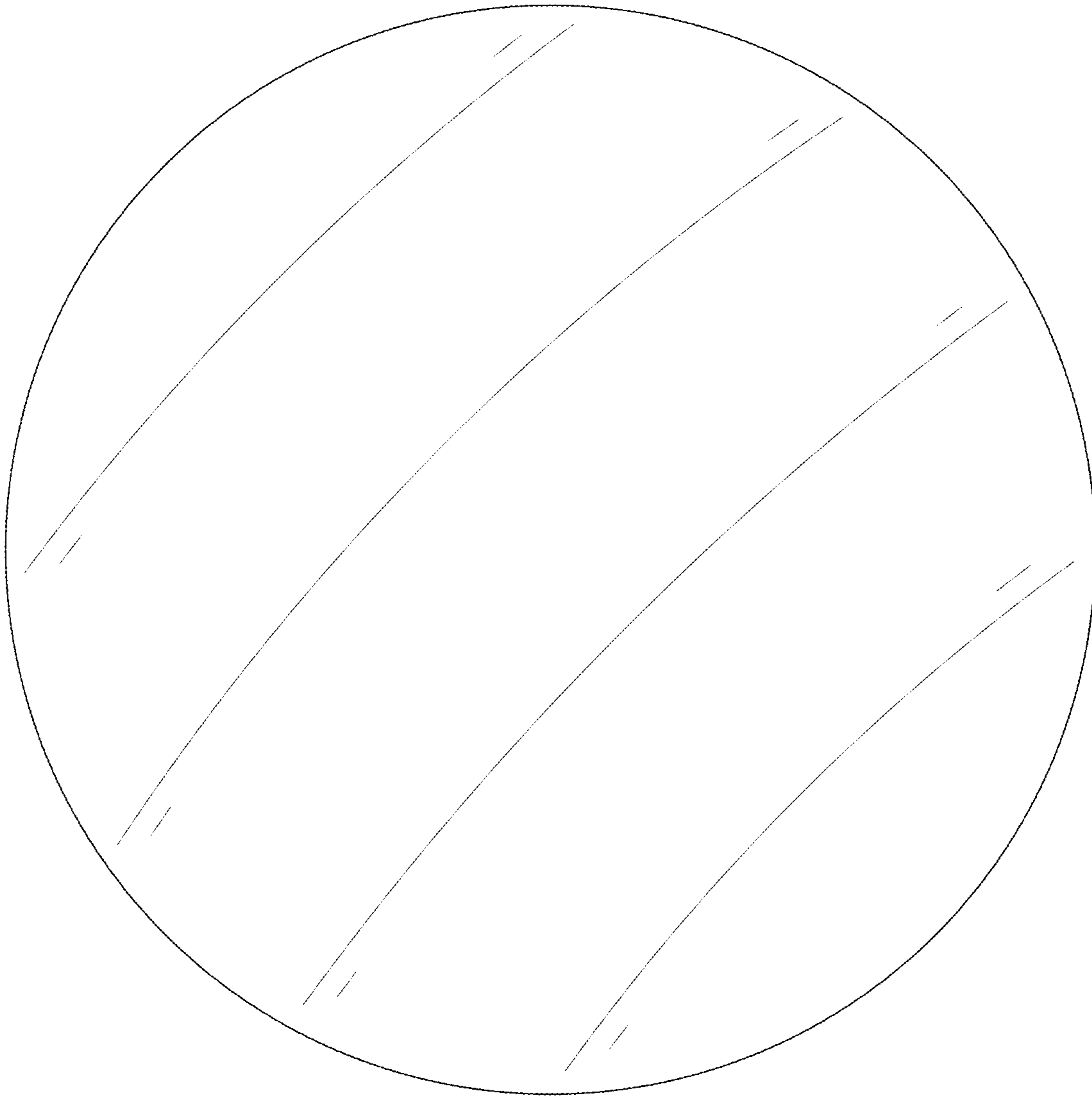

FIG. 7



FIG. 8

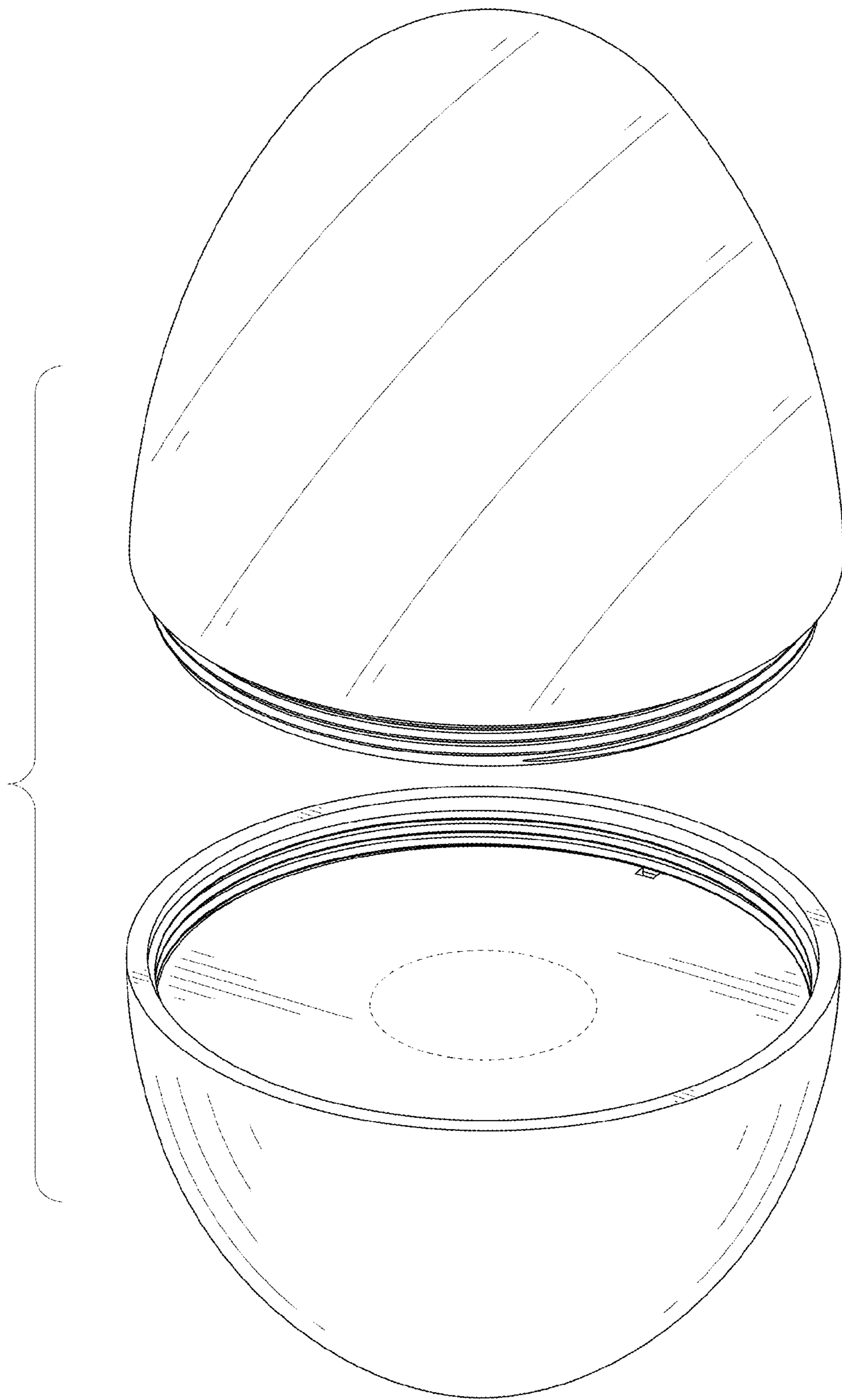

FIG. 9