



US00D946754S

(12) **United States Design Patent** (10) **Patent No.:** **US D946,754 S**  
**Paramadilok** (45) **Date of Patent:** **\*\* Mar. 22, 2022**

- (54) **ELECTRONIC DEVICE**
- (71) Applicant: **Sidney Paramadilok**, Chicago, IL (US)
- (72) Inventor: **Sidney Paramadilok**, Chicago, IL (US)
- (73) Assignee: **Triton Holdings, LLC**, Elmhurst, IL (US)
- (\*\*) Term: **15 Years**
- (21) Appl. No.: **29/650,410**
- (22) Filed: **Jun. 6, 2018**

**Related U.S. Application Data**

- (63) Continuation-in-part of application No. 29/597,748, filed on Mar. 20, 2017, now Pat. No. Des. 863,554.
- (51) **LOC (13) Cl.** ..... **24-02**
- (52) **U.S. Cl.**  
USPC ..... **D24/146**
- (58) **Field of Classification Search**  
USPC ..... D24/110, 112, 115, 133, 146, 147, 148;  
D8/300, 310, 311; D28/52, 53, 54, 55,  
D28/56, 57, 58, 59, 60, 61, 62, 63  
CPC ..... A61B 2018/00607; A61B 2018/00601;  
A61B 17/34; A61B 17/32; A61B 17/16;  
A61B 17/14  
See application file for complete search history.

(56) **References Cited**

**U.S. PATENT DOCUMENTS**

D490,894 S *	6/2004	Bogazzi	.....	D24/133
D490,895 S *	6/2004	Bogazzi	.....	D24/133
D490,896 S *	6/2004	Bogazzi	.....	D24/133
D560,806 S *	1/2008	Eckman	.....	D24/147
D596,353 S *	7/2009	Yang	.....	D24/147
D638,935 S *	5/2011	Gilmore, III	.....	D24/133
D716,446 S *	10/2014	Bitaraf	.....	D24/146
D723,160 S *	2/2015	Rodan	.....	D24/146
D728,098 S *	4/2015	Schad	.....	D24/146
D743,549 S *	11/2015	Sarig	.....	D24/146
D803,398 S *	11/2017	Israni	.....	D24/146

D863,554 S *	10/2019	Paramadilok	.....	D24/146
2009/0071491 A1 *	3/2009	Yang	.....	A61B 17/54 132/200
2011/0270274 A1 *	11/2011	Hull, Jr.	.....	A45D 34/04 606/131

**OTHER PUBLICATIONS**

[https://www.amazon.com/dp/B078Z8LKB9/ref=sspa\\_dk\\_detail\\_5?psc=1&pd\\_rd\\_i=B078Z8LKB9&pd\\_rd\\_w=RWwDS&pf\\_rd\\_p=91afecf5-8b2e-41e2-9f11-dc6992c6eaa1&pd\\_rd\\_wg=PI6Gt&pf\\_rd\\_r=51R2K7KT0S4ECNR3SEYE&pd\\_rd\\_r=be034104-6c9e-498c-b4cf-652b8990c9fd&spLa=ZW5jcnlwdGVkUXVhbGlmaWVyPUEyT1JEVzJHsvRlMIg2JmVuY3J5cHRIZEikPUEwMjYzZW5jcnlwdGVkUXVhbGlmaWVyPUEyT1JEVzJHsvRlMIg2JmVuY3J5cHRIZEikPUEwMjY2ODU0MVYwQlg1NEgwSIJBOSZlbnNyeXB0ZW50ZW50ZW50MDEwOTIxMURUNjBERjRPMjZEUyZ3aWRnZXROYW1IPXNwX2RldGFpbCZlY3Rpb249Y2xpY2tSZWRpc mVjdCZkb05vdExvZ0NsaWNrPXRydWU=](https://www.amazon.com/dp/B078Z8LKB9/ref=sspa_dk_detail_5?psc=1&pd_rd_i=B078Z8LKB9&pd_rd_w=RWwDS&pf_rd_p=91afecf5-8b2e-41e2-9f11-dc6992c6eaa1&pd_rd_wg=PI6Gt&pf_rd_r=51R2K7KT0S4ECNR3SEYE&pd_rd_r=be034104-6c9e-498c-b4cf-652b8990c9fd&spLa=ZW5jcnlwdGVkUXVhbGlmaWVyPUEyT1JEVzJHsvRlMIg2JmVuY3J5cHRIZEikPUEwMjYzZW5jcnlwdGVkUXVhbGlmaWVyPUEyT1JEVzJHsvRlMIg2JmVuY3J5cHRIZEikPUEwMjY2ODU0MVYwQlg1NEgwSIJBOSZlbnNyeXB0ZW50ZW50ZW50MDEwOTIxMURUNjBERjRPMjZEUyZ3aWRnZXROYW1IPXNwX2RldGFpbCZlY3Rpb249Y2xpY2tSZWRpc mVjdCZkb05vdExvZ0NsaWNrPXRydWU=) Jan. 13, 2018 (Year: 2018).\*

\* cited by examiner

*Primary Examiner* — Samantha Q Lawrence  
(74) *Attorney, Agent, or Firm* — Dunlap Bennett & Ludwig, PLLC

(57) **CLAIM**

The ornamental design for an electronic device, as shown and described.

**DESCRIPTION**

FIG. 1 is a perspective view of an electronic device in accordance with the present invention; FIG. 2 is a front elevation view thereof; FIG. 3 is a rear elevation view thereof; FIG. 4 is a top plan view thereof; FIG. 5 is a bottom plan view thereof; FIG. 6 is a left side elevation view thereof; and, FIG. 7 is a right side elevation view thereof. The broken lines shown in the drawings depict portions of the electronic device that form no part of the claimed design.

**1 Claim, 3 Drawing Sheets**

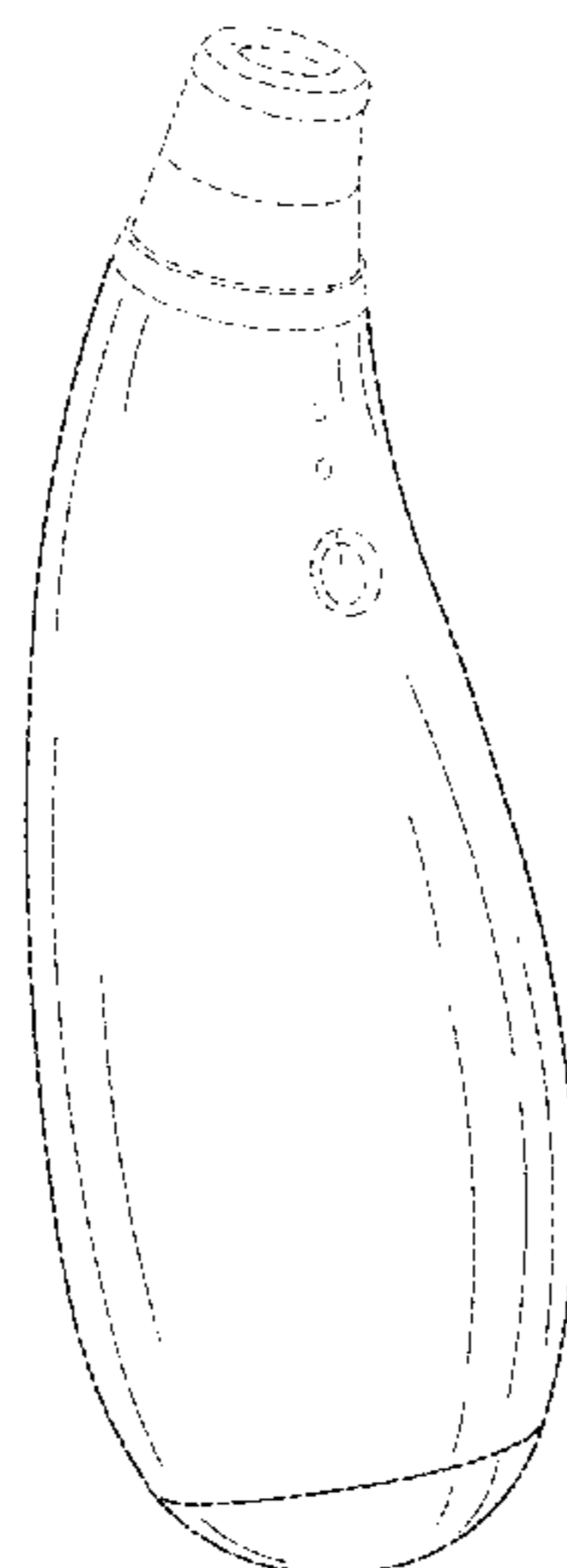

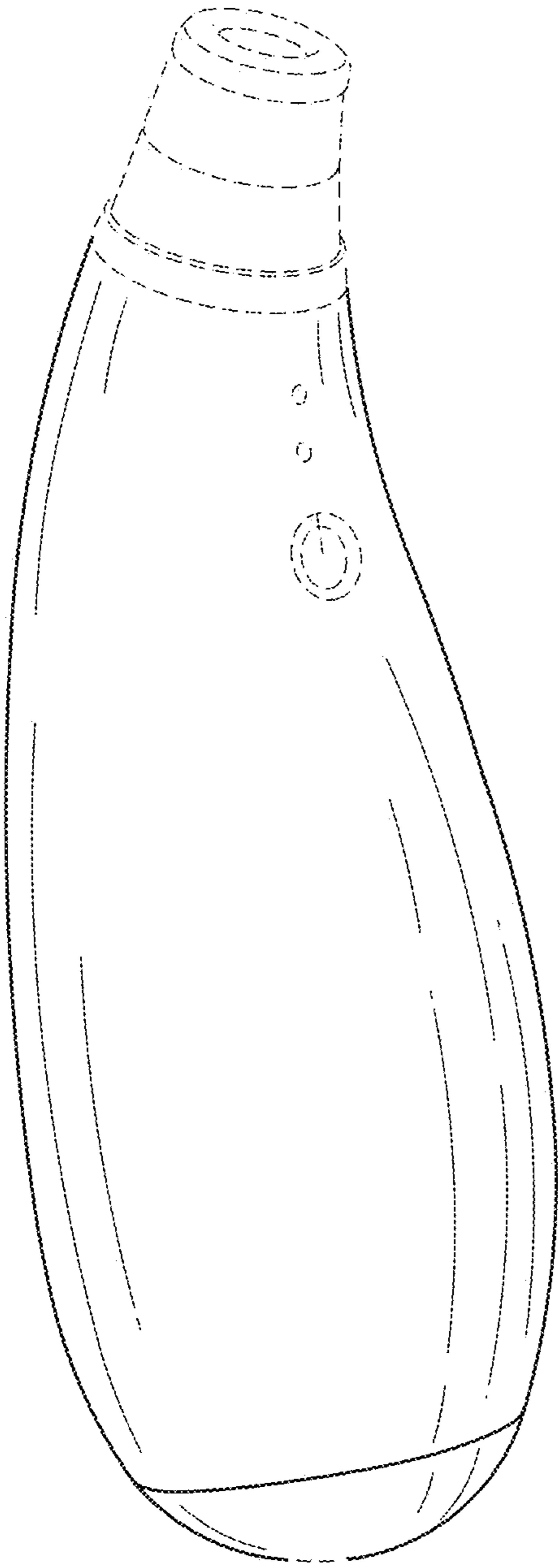

FIG. 1

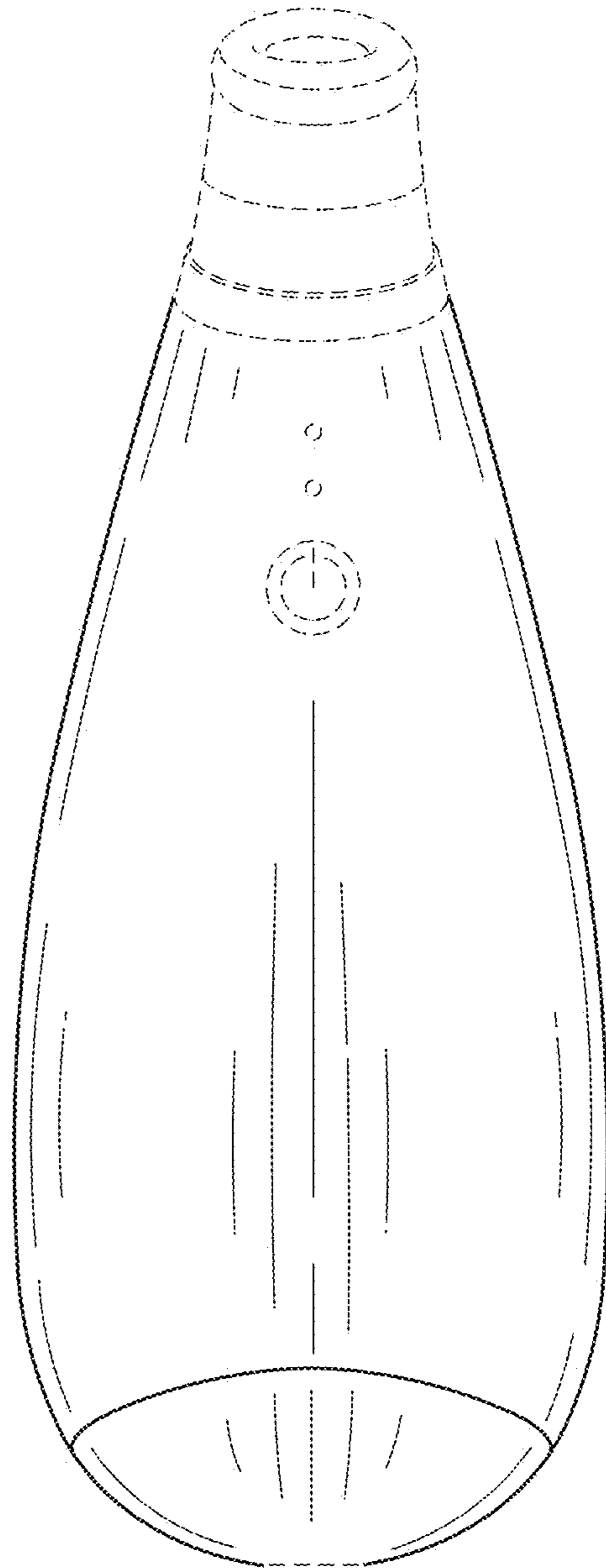

FIG. 2

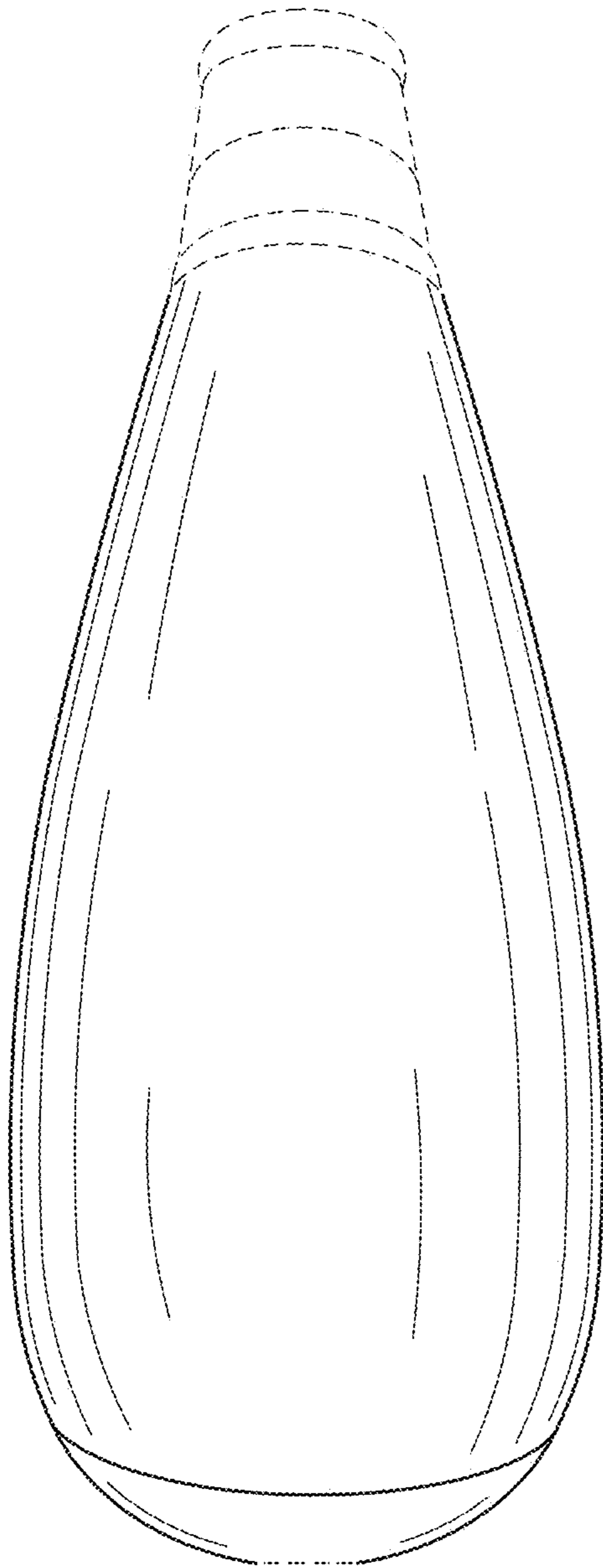

FIG. 3

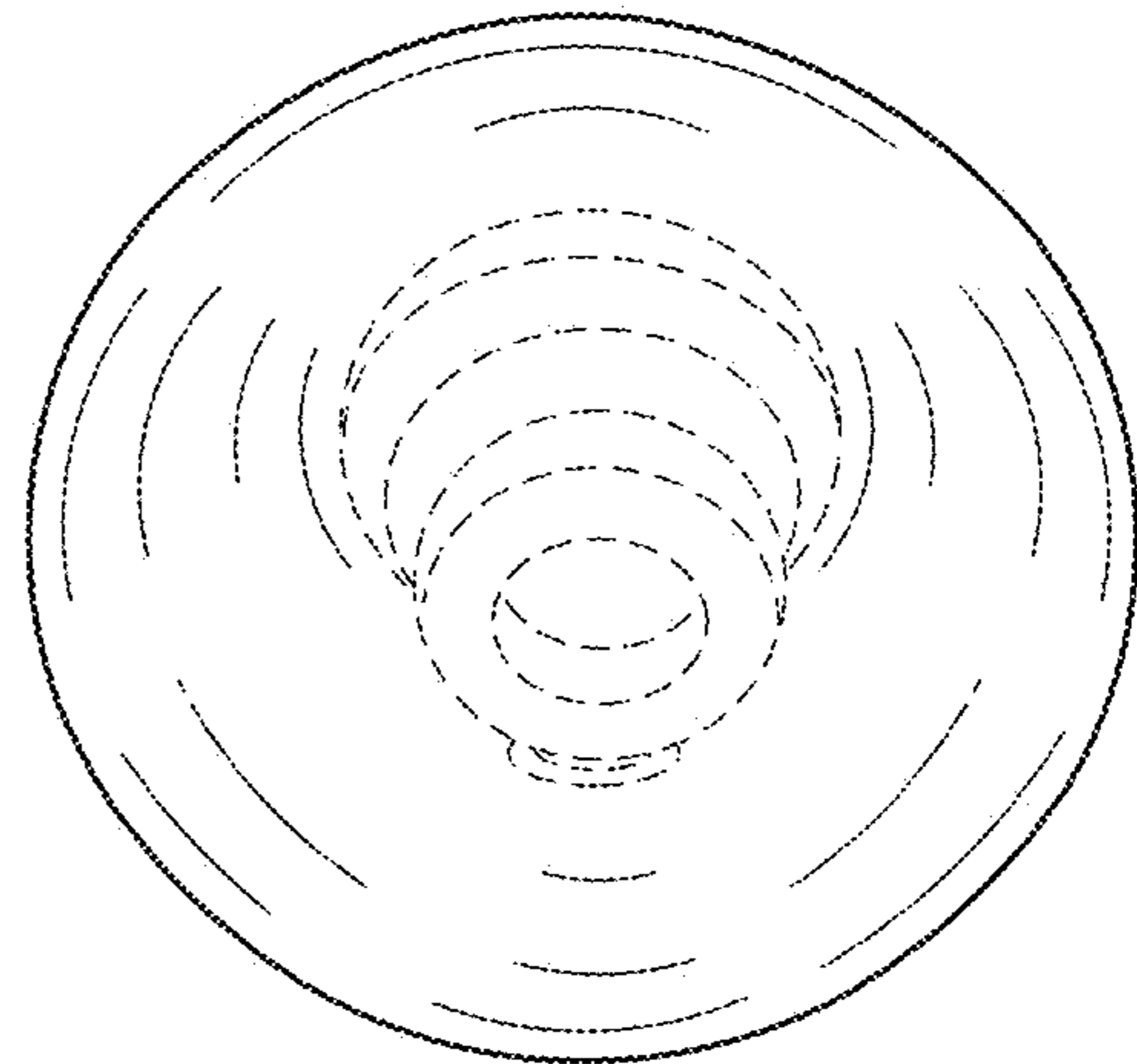

FIG. 4

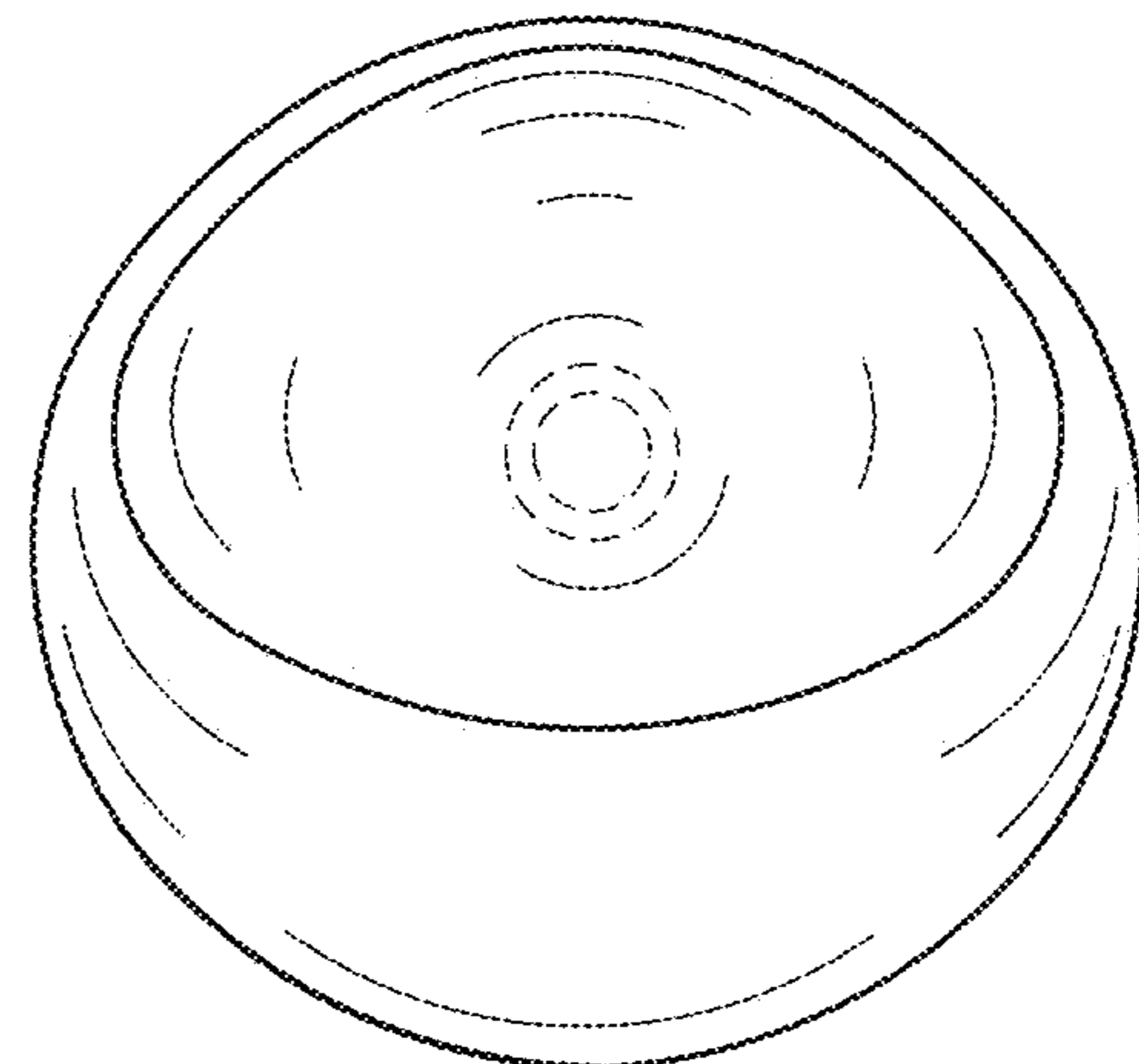

FIG. 5



FIG. 6

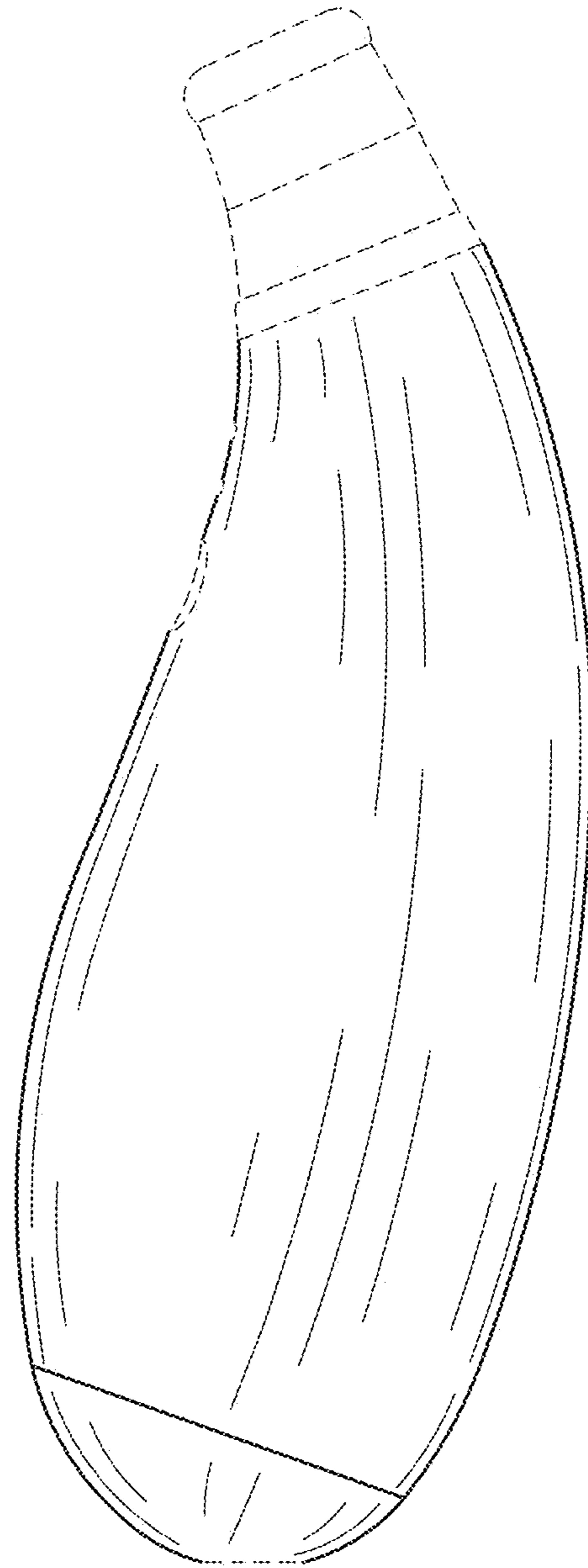

FIG. 7