



US00D946683S

(12) **United States Design Patent**
Vu

(10) **Patent No.:** **US D946,683 S**
(45) **Date of Patent:** **** Mar. 22, 2022**

- (54) **GOLF CLUB HEAD**
- (71) Applicant: **Callaway Golf Company**, Carlsbad, CA (US)
- (72) Inventor: **Thomas Vu**, Westminster, CA (US)
- (73) Assignee: **Callaway Golf Company**, Carlsbad, CA (US)
- (**) Term: **15 Years**
- (21) Appl. No.: **29/747,319**
- (22) Filed: **Aug. 21, 2020**
- (51) **LOC (13) Cl.** **21-02**
- (52) **U.S. Cl.**
USPC **D21/759**
- (58) **Field of Classification Search**
USPC D21/747-751, 759
CPC A63B 53/00; A63B 53/02; A63B 53/04;
A63B 53/047; A63B 53/0475; A63B 2053/0479; A63B 2053/0483; A63B 2053/0445; A63B 60/00; A63B 60/46
See application file for complete search history.

D467,292 S *	12/2002	Saraie	D21/749
D508,722 S *	8/2005	Iwata	D21/759
D518,538 S *	4/2006	Ines	D21/747
D526,036 S *	8/2006	Nishitani	D21/747
D647,987 S *	11/2011	Atwell	D21/747
D648,409 S *	11/2011	Atwell	D21/747
D909,509 S *	2/2021	Cyrulik	D21/747
D922,506 S *	6/2021	Parsons	D21/747
D934,364 S *	10/2021	Dempsey	D21/747
D935,542 S *	11/2021	Parsons	D21/747
D938,533 S *	12/2021	Nicolette	D21/747

* cited by examiner

Primary Examiner — Mitchell I. Siegel
(74) *Attorney, Agent, or Firm* — Rebecca Hanovice; Michael Catania; Sonia Lari

(57) **CLAIM**

The ornamental design for a golf club head, as shown and described.

DESCRIPTION

FIG. 1 is a rear perspective view of the golf club head claimed herein;
FIG. 2 is a rear elevational view thereof;
FIG. 3 is a front elevational view thereof;
FIG. 4 is a right side elevational view thereof;
FIG. 5 is a left side elevational view thereof;
FIG. 6 is a top plan view thereof; and,
FIG. 7 is a bottom plan view thereof.
The broken lines in the figures show portions of the golf club head that form no part of the claimed design.

1 Claim, 4 Drawing Sheets

- (56) **References Cited**
U.S. PATENT DOCUMENTS
D383,820 S * 9/1997 Watanabe D21/749
D454,606 S * 3/2002 Helmstetter D21/747
D466,576 S * 12/2002 Nagai D21/759
D466,961 S * 12/2002 Nagai D21/759

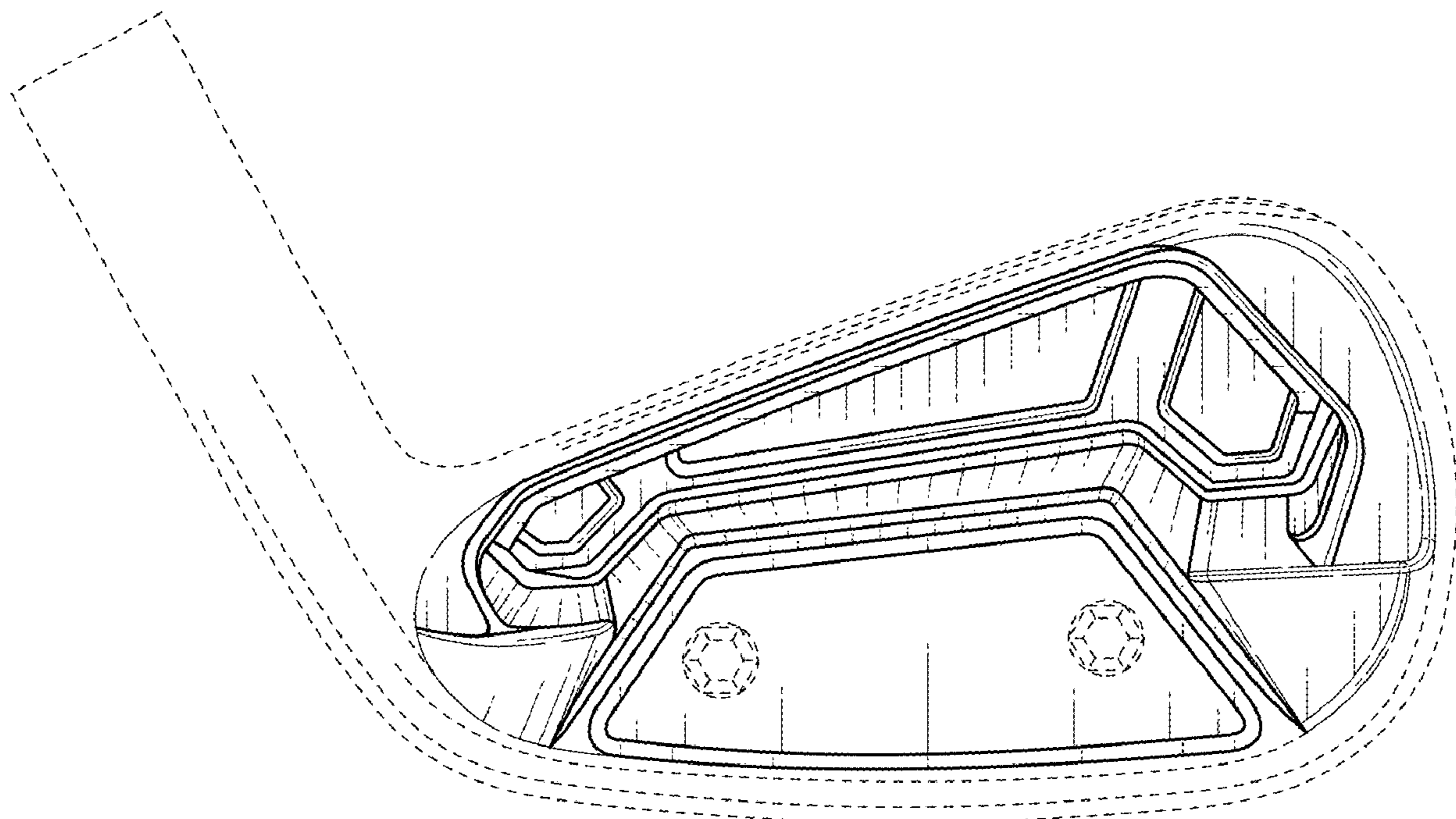

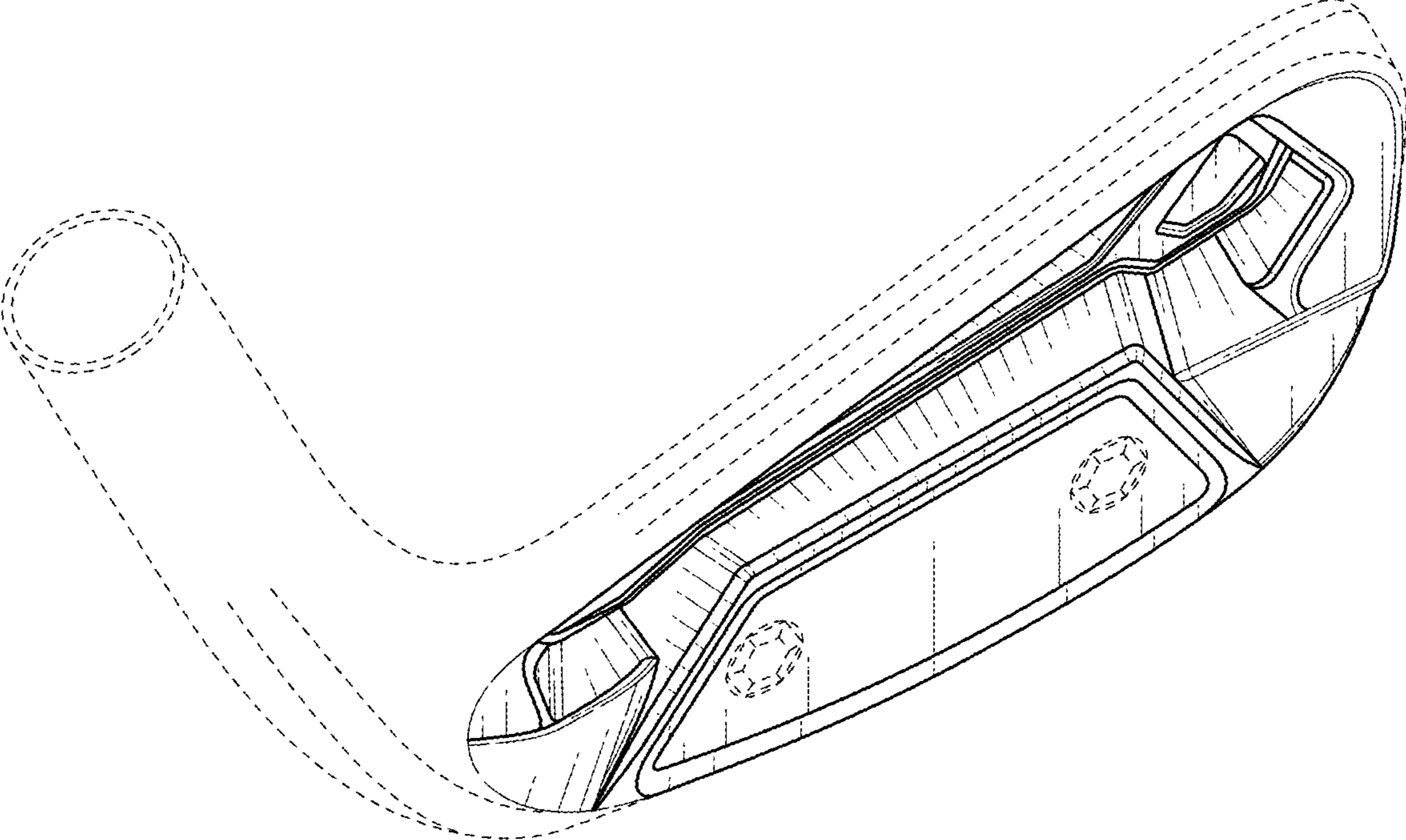

FIG. 1

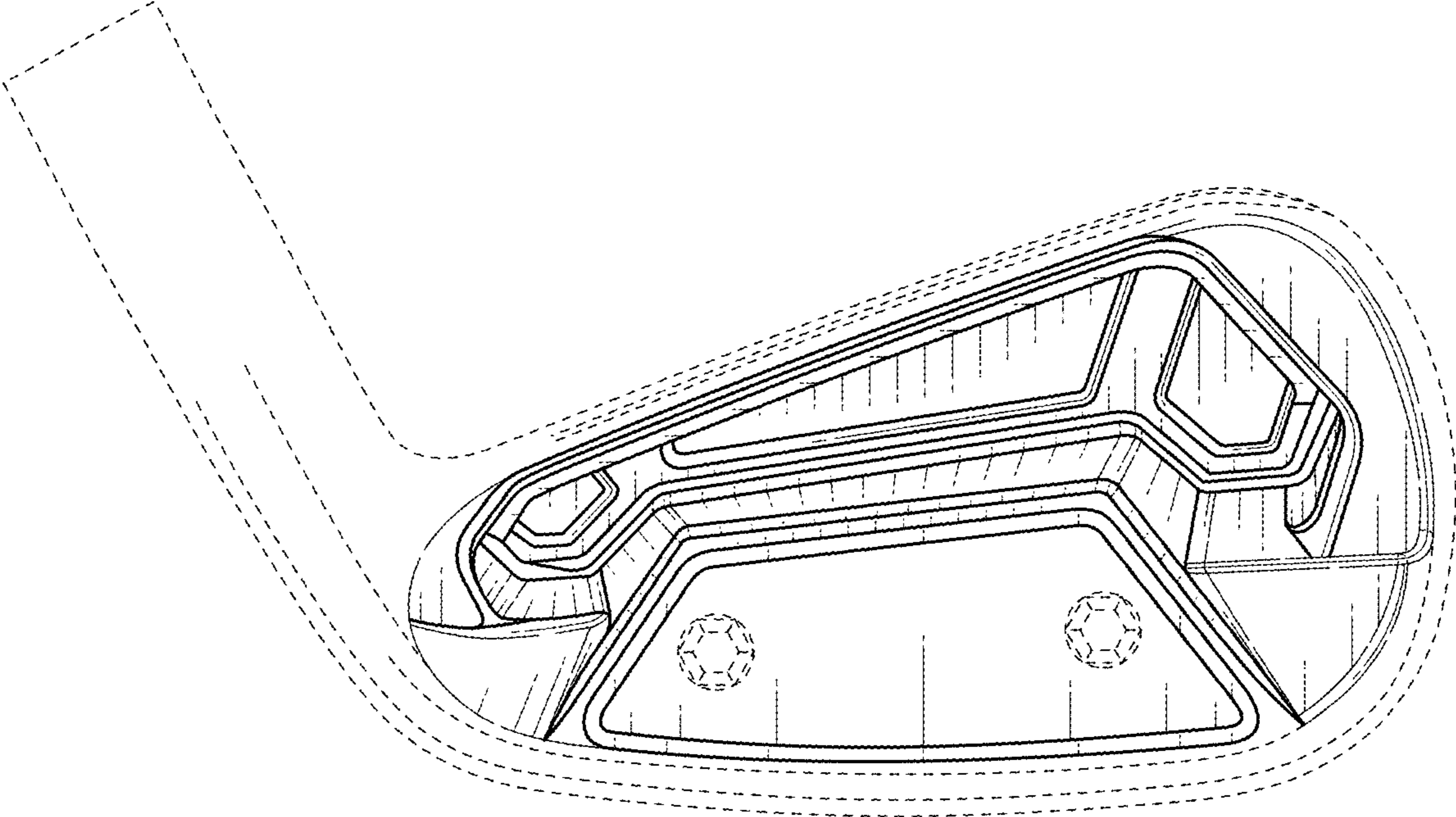

FIG. 2

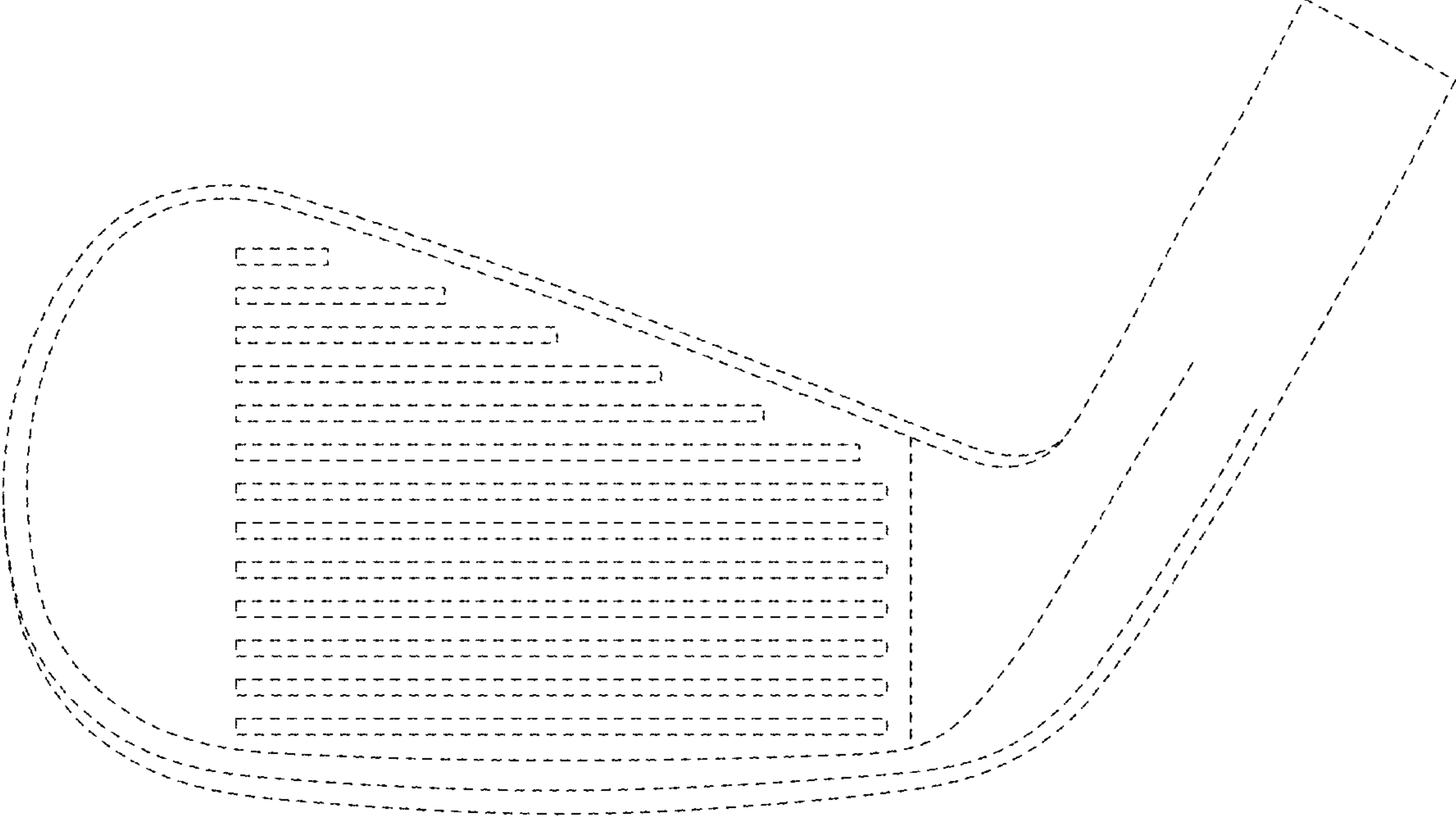

FIG. 3

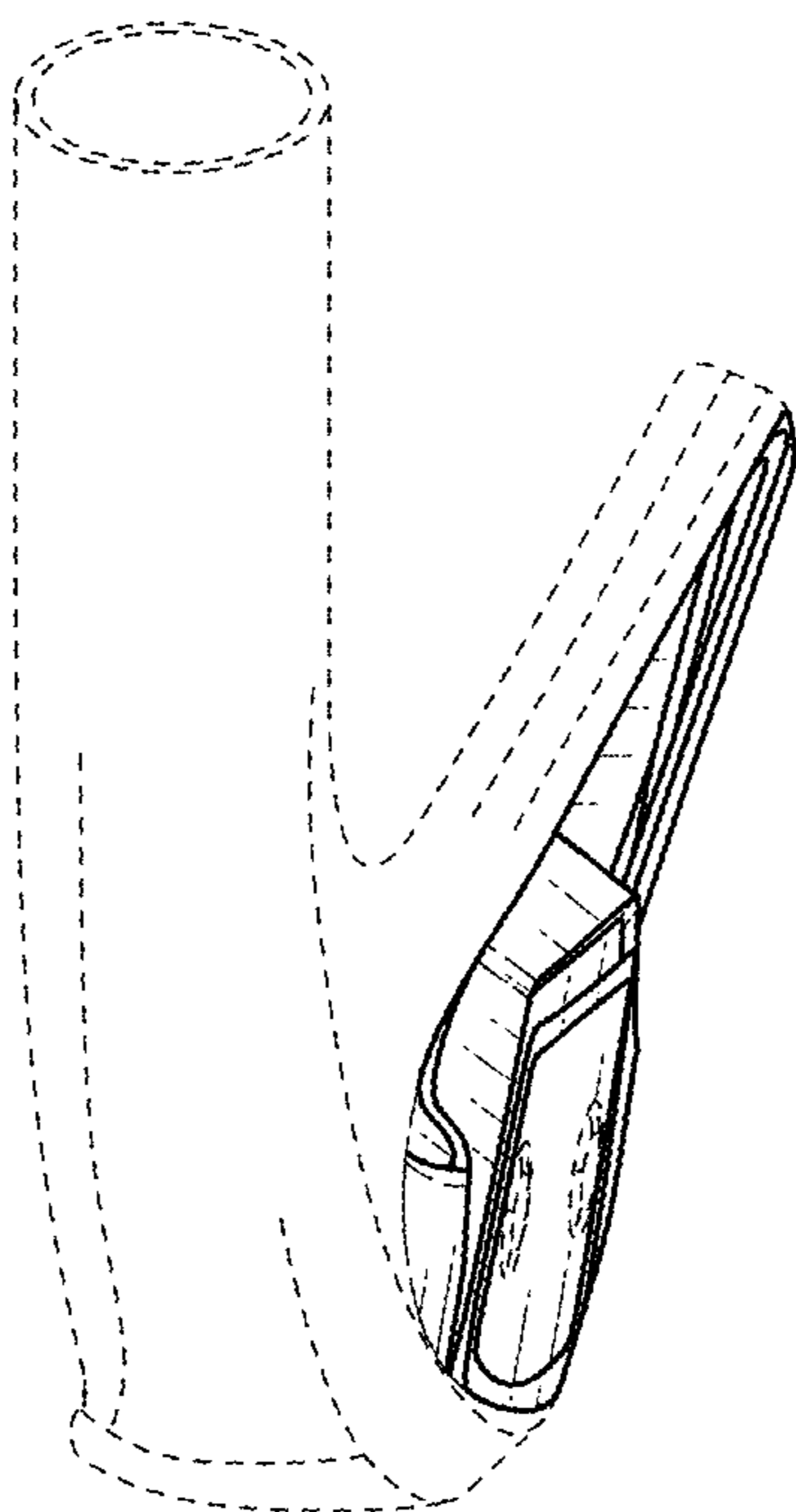

FIG. 4

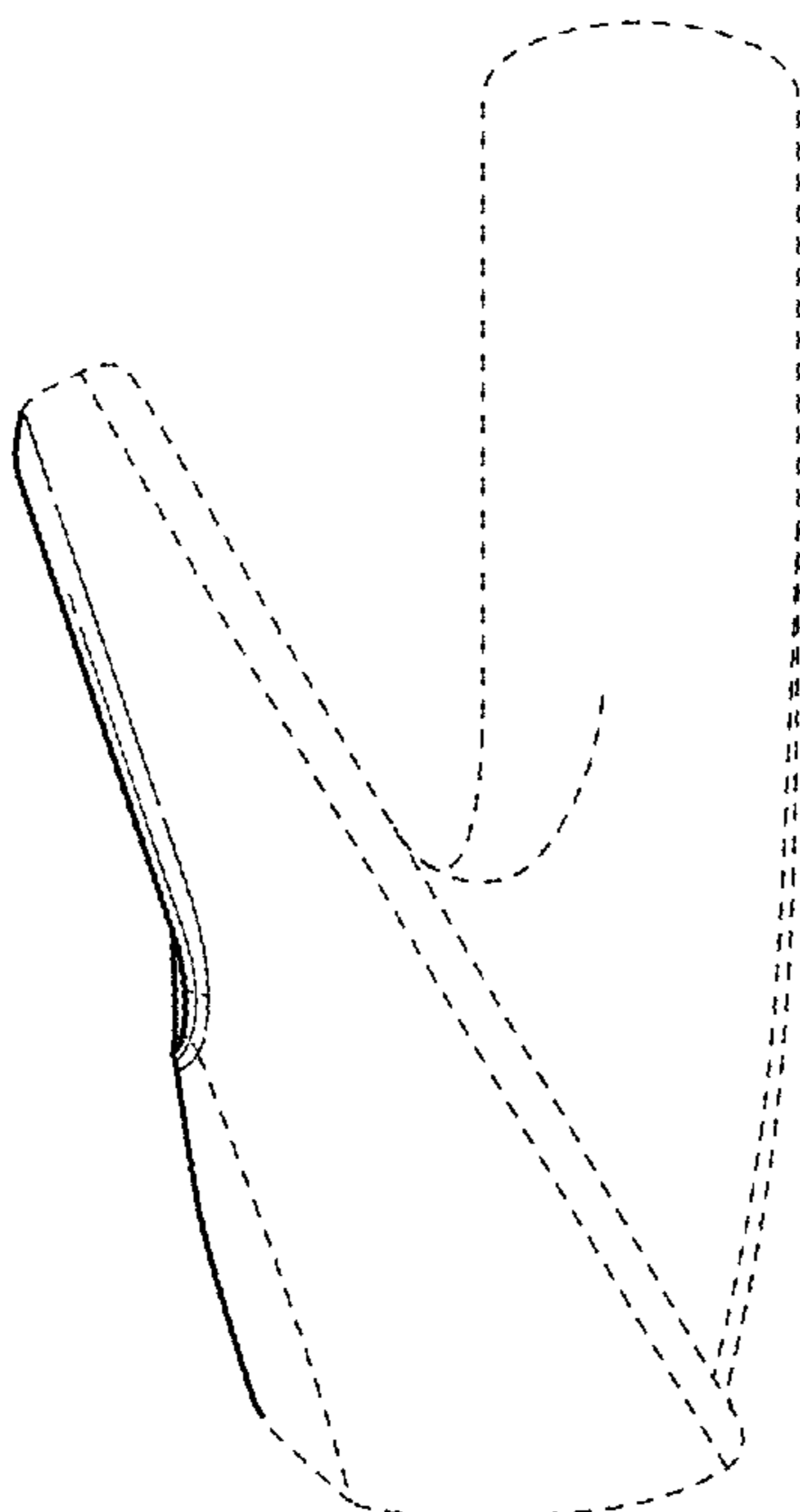

FIG. 5

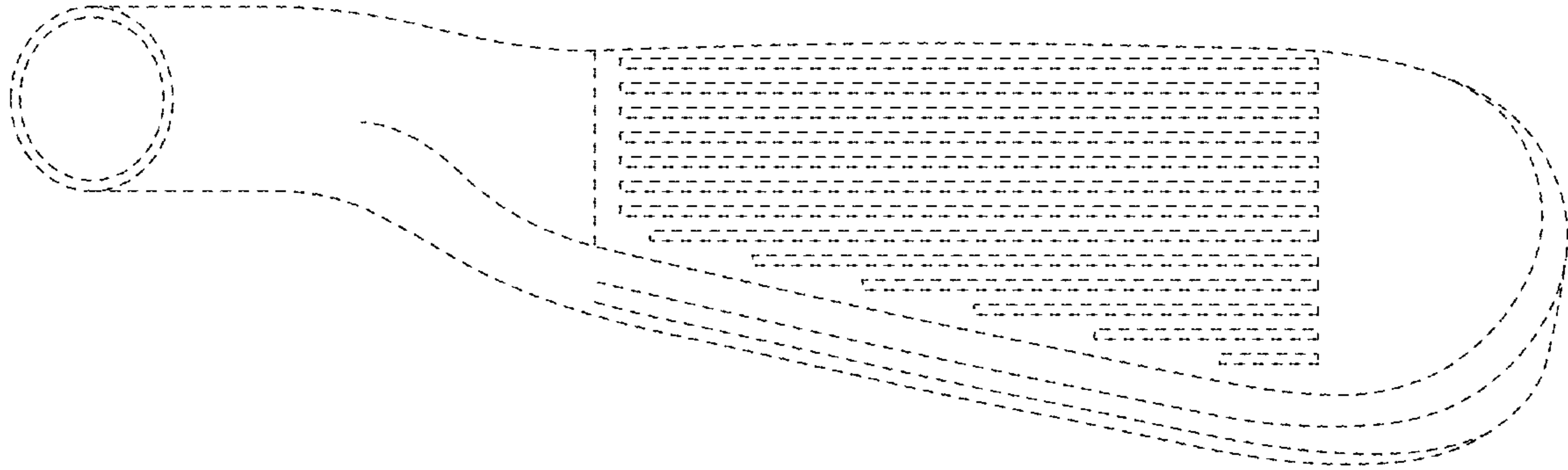

FIG. 6

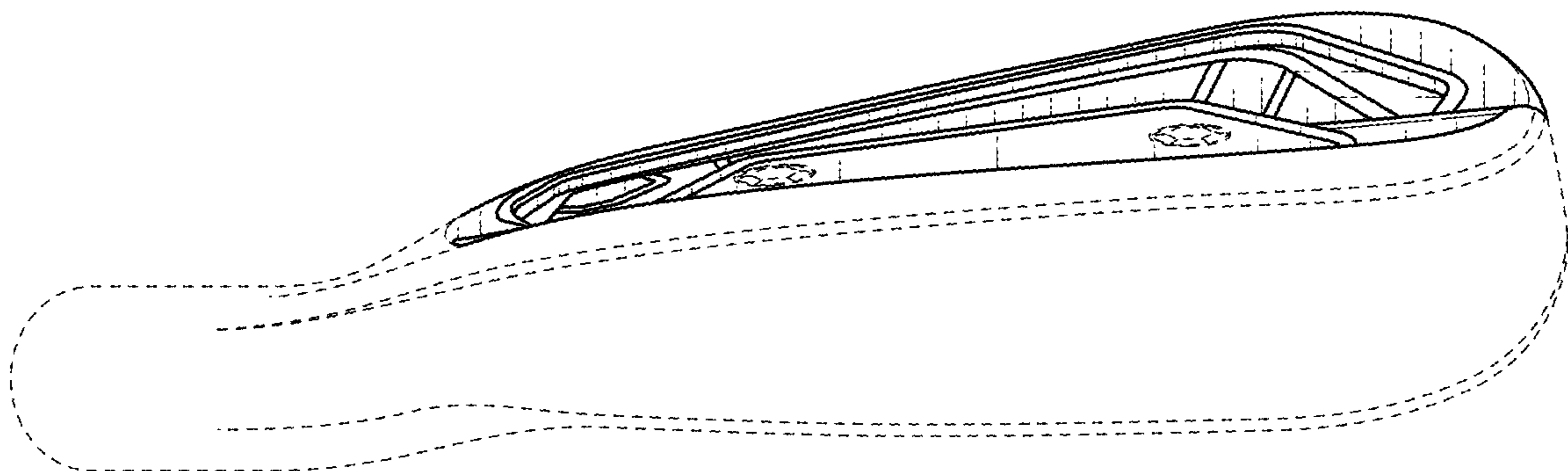

FIG. 7