



US00D946667S

(12) **United States Design Patent** (10) **Patent No.:** **US D946,667 S**
Hagler et al. (45) **Date of Patent:** **** Mar. 22, 2022**

(54) **MODEL VEHICLE FAIRLEAD**
(71) Applicant: **TRAXXAS LP**, McKinney, TX (US)
(72) Inventors: **Skylar Hagler**, Anna, TX (US); **Terry Soward**, Van Alstyne, TX (US); **Otto Karl Allmendinger**, Rowlett, TX (US); **Kent Poteet**, Lucas, TX (US)

D656,562 S 3/2012 Papp et al.
D663,789 S 7/2012 Papp et al.
D691,217 S 10/2013 Condon et al.
D731,293 S * 6/2015 Fretz D8/356
D744,897 S * 12/2015 Badgett D11/210
(Continued)

(73) Assignee: **TRAXXAS LP**, McKinney, TX (US)

FOREIGN PATENT DOCUMENTS

CN 306586873 * 6/2021

(**) Term: **15 Years**

OTHER PUBLICATIONS

(21) Appl. No.: **29/736,731**

Fairlead, winch, available on Traxxas.com, [site visited Jan. 24, 2022], URL: <https://traxxas.com/products/parts/8859> (Year: 2022).*
(Continued)

(22) Filed: **Jun. 2, 2020**

(51) **LOC (13) Cl.** **21-01**

Primary Examiner — Dana K Weiland
Assistant Examiner — Emily Anna Saunders

(52) **U.S. Cl.**

USPC **D21/561**; D8/356; D12/169

(74) *Attorney, Agent, or Firm* — Daryl R. Wright; Greg Carr

(58) **Field of Classification Search**

USPC D21/561, 562, 548; D15/28; D8/356, D8/354, 349; D12/167, 171

CPC B60R 19/02; B60R 19/44; B60T 7/22; B66D 1/00; B66D 1/36; E02D 5/803; B63B 21/00; B63B 21/045; B63B 59/02; B60D 1/00; B60D 1/14; B60D 1/18; B60D 2001/001

See application file for complete search history.

(57) **CLAIM**

We claim the ornamental design for a model vehicle fairlead, as shown and described.

DESCRIPTION

(56) **References Cited**

U.S. PATENT DOCUMENTS

D410,045 S 5/1999 Fletcher
D447,725 S * 9/2001 Hatter D12/169
D447,728 S * 9/2001 McCoy D12/406
D468,371 S 1/2003 So
D485,587 S 1/2004 Hui
D516,472 S * 3/2006 Taguchi D12/169
D550,720 S 9/2007 Geisler et al.
D550,924 S 9/2007 Huang
D591,365 S 4/2009 Pasko et al.
D605,098 S * 12/2009 Bennett D12/169
D645,799 S * 9/2011 Beigel D12/169

FIG. 1 is an upper, left, front perspective view of a model vehicle fairlead showing our new design; FIG. 2 is a front elevation view thereof; FIG. 3 is a rear elevation view thereof; FIG. 4 is a left side elevation view thereof; FIG. 5 is a right side elevation view thereof; FIG. 6 is an upper plan view thereof; FIG. 7 is a lower plan view thereof; and, FIG. 8 is a lower, right, rear perspective view of the model vehicle fairlead.

In the drawings, the broken lines illustrate portions of the model vehicle fairlead that form no part of the claimed design.

1 Claim, 5 Drawing Sheets

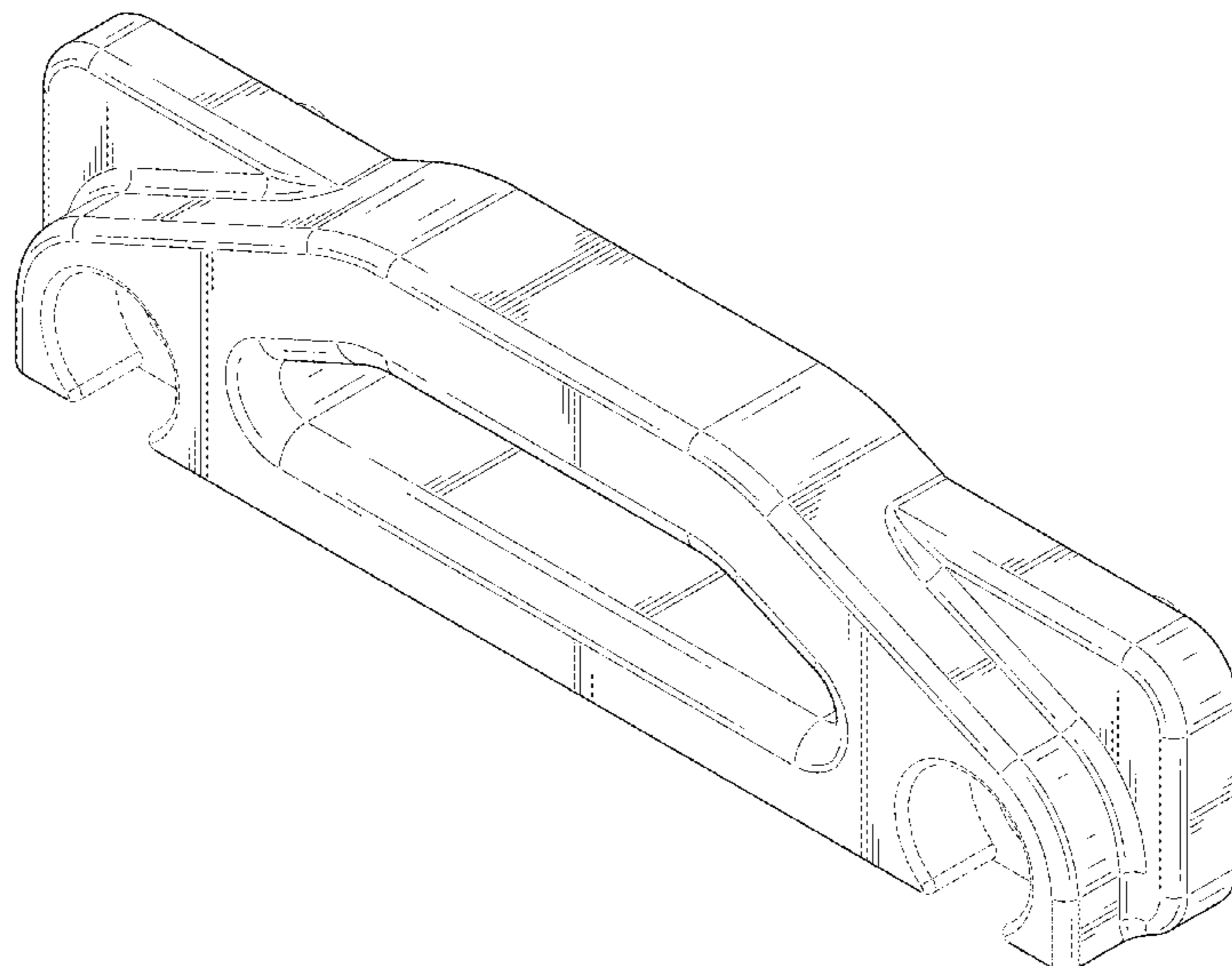

(56)

References Cited

U.S. PATENT DOCUMENTS

D778,265	S	2/2017	Parfitt	
D799,144	S	10/2017	Cui	
D807,731	S *	1/2018	Fretz	D8/356
D807,732	S *	1/2018	Fretz	D8/356
D807,733	S *	1/2018	Fretz	D8/356
D808,890	S *	1/2018	Fenchak	D12/414
D811,683	S	2/2018	Frazier et al.	
D824,299	S *	7/2018	Stone	D12/169
D844,073	S	3/2019	Kim et al.	
D873,731	S *	1/2020	Goodrich	D12/169
10,562,743	B2 *	2/2020	Fretz	B66D 1/36
D888,360	S	6/2020	Zheng	
D896,463	S	9/2020	Saeger et al.	
D898,321	S	10/2020	Fretz et al.	
D901,821	S *	11/2020	Zheng	D34/35
D902,706	S *	11/2020	Sprowl	D8/399
D906,624	S	12/2020	Wilcox et al.	
D908,473	S *	1/2021	Montes	D8/356
D923,111	S *	6/2021	Wood	D21/561
D923,906	S	6/2021	Fogg et al.	
D931,951	S	9/2021	Isono et al.	
D933,759	S	10/2021	Pai	
D934,958	S	11/2021	Du	
2014/0001427	A1	1/2014	Fretz et al.	
2014/0252286	A1	9/2014	Averill et al.	
2017/0320710	A1 *	11/2017	Fretz	B63B 21/14
2018/0118528	A1	5/2018	August et al.	
2018/0273357	A1	9/2018	Huang	
2019/0092608	A1	3/2019	Cui	
2019/0233263	A1 *	8/2019	Hall	B66D 1/36
2021/0130143	A1 *	5/2021	Fretz	B66D 1/46

OTHER PUBLICATIONS

Traxxas 8859 Fairlead, available on cobbco.store, [site visited Jan. 24, 2022], URL: <https://cobbco.store/products/traxxas-8859-fairlead-winch-fairlead-winch> (Year: 2022).*

Winch Fairleads—What They are and why you Need One, available on agency6.com, date published Mar. 22, 2021, [site visited Jan. 24, 2022], URL: <https://agency6.com/blogs/news/winch-fairleads-what-they-are-and-why-you-need-one> (Year: 2021).*

WARN 97900 Hawse Fairlead, available on [montanajacks.com](https://www.montanajacks.com), [site visited Jan. 24, 2022], URL: <https://www.montanajacks.com/products/warn-97900-hawse-fairlead-for-vr-series-winch-cast-iron> (Year: 2022).*

Slee Offset Hawse Fairlead, available on sleeffroad.com, [site visited Jan. 24, 2022], URL: <https://sleeffroad.com/products/sof1113/> (Year: 2022).*

Apex Aluminum Hawse Fairlead, available on [harborfreight.com](https://www.harborfreight.com), oldest customer review Feb. 29, 2020, [site visited Jan. 24, 2022], URL: <https://www.harborfreight.com/apex-aluminum-hawse-fairlead-56414.html> (Year: 2020).*

Warn 87914 Hawse Style Winch Fairlead, available on Amazon.com, date first available Jan. 1, 2012, [site visited Jan. 24, 2022], URL: <https://www.amazon.com/WARN-87914-Hawse-Fairlead/dp/B007KCNAK8> (Year: 2012).*

Warn 100655 Winch, available on Amazon.com, date first available Sep. 8, 2018, [site visited Jan. 24, 2022], URL: <https://www.amazon.com/WARN-100655-Black-Epic-Fairlead/dp/B07H6B6NFK/> (Year: 2018).*

Flipper Big Button Remote for Seniors, Jul. 9, 2009, [amazon.com](https://www.amazon.com), Dec. 29, 2021, URL: <https://www.amazon.com/Flipper-Big-Button-Remote-Seniors/dp/B002GR1YZ0> (Year: 2009).

Universal Big Button TV Remote—EasyMote, Sep. 28, 2016, [amazon.com](https://www.amazon.com), Dec. 29, 2021, URL: <https://www.amazon.com/Universal-Big-Button-Remote-Television/dp/B01M1UV2T2> (Year: 2016).

Key Finder, Vodeson Wireless Key Tracker, Item Tag Locator, Beeper Alarm, Aug. 12, 2019, [amazon.com](https://www.amazon.com), Dec. 29, 2021, URL: <https://www.amazon.com/VODESON-Wireless-Finder-Locator-Tracker/dp/B07WF7LTRW> (Year: 2019).

* cited by examiner

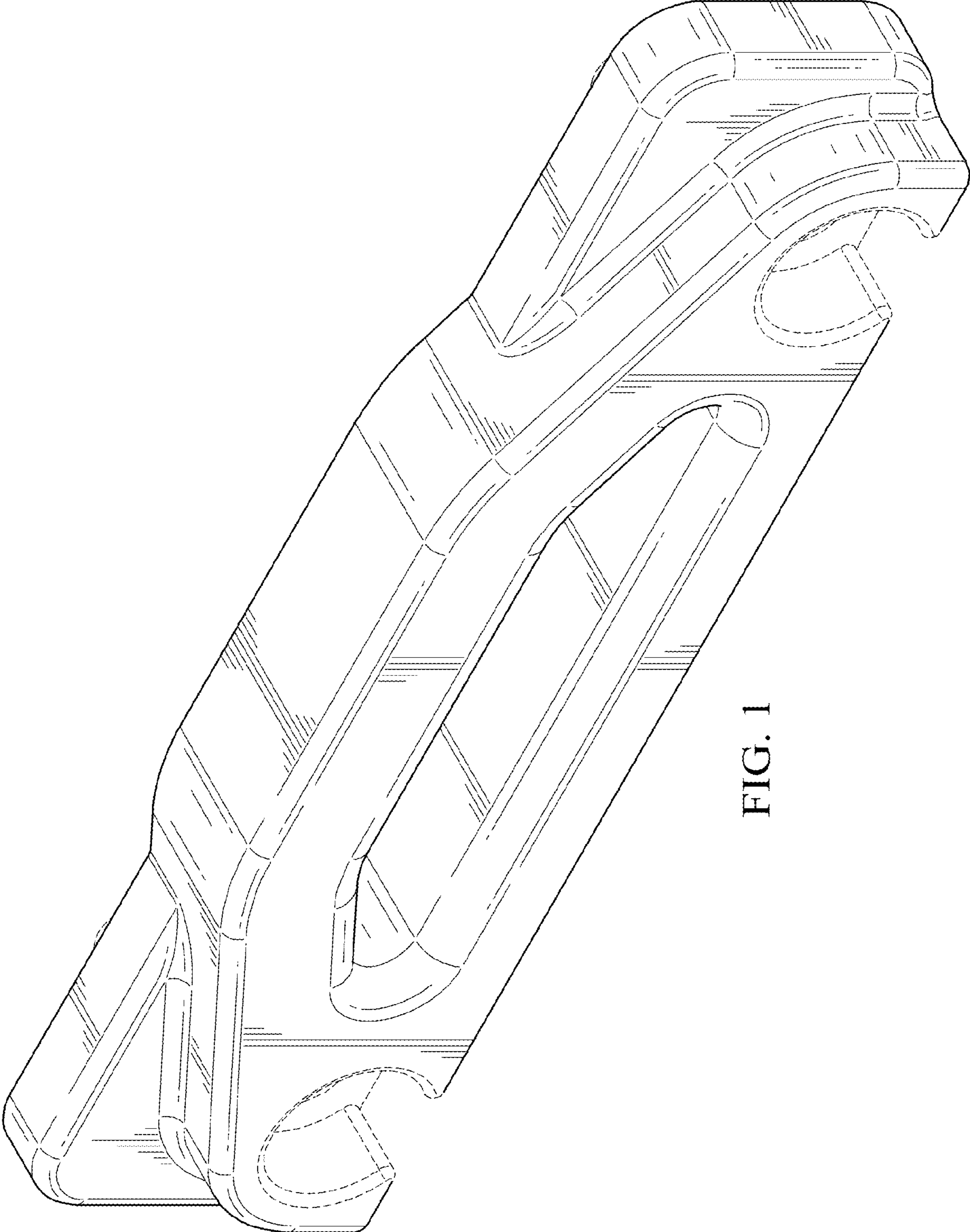

FIG. 1

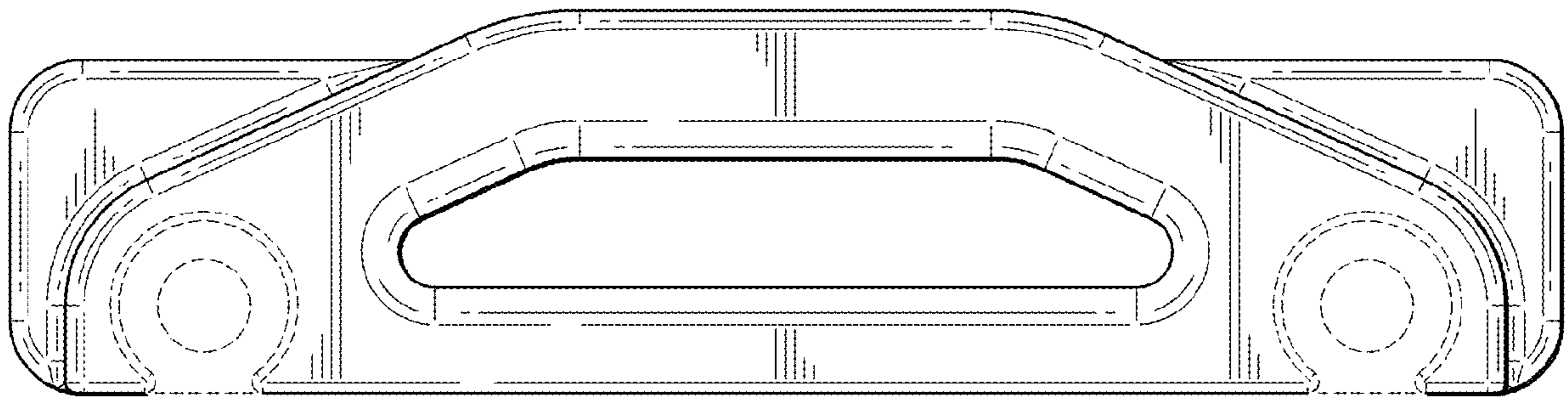

FIG. 2

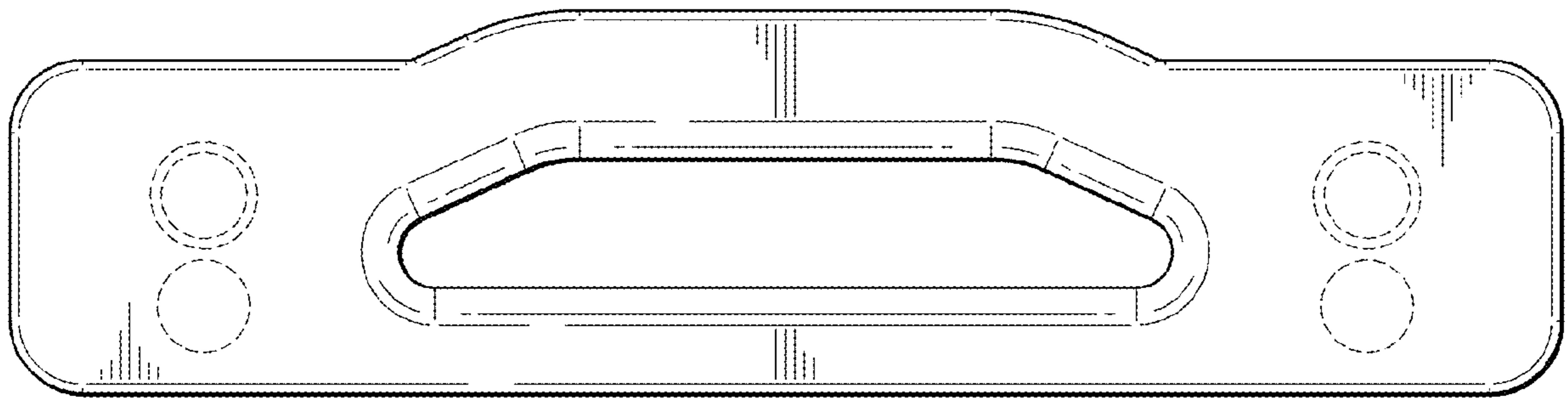

FIG. 3

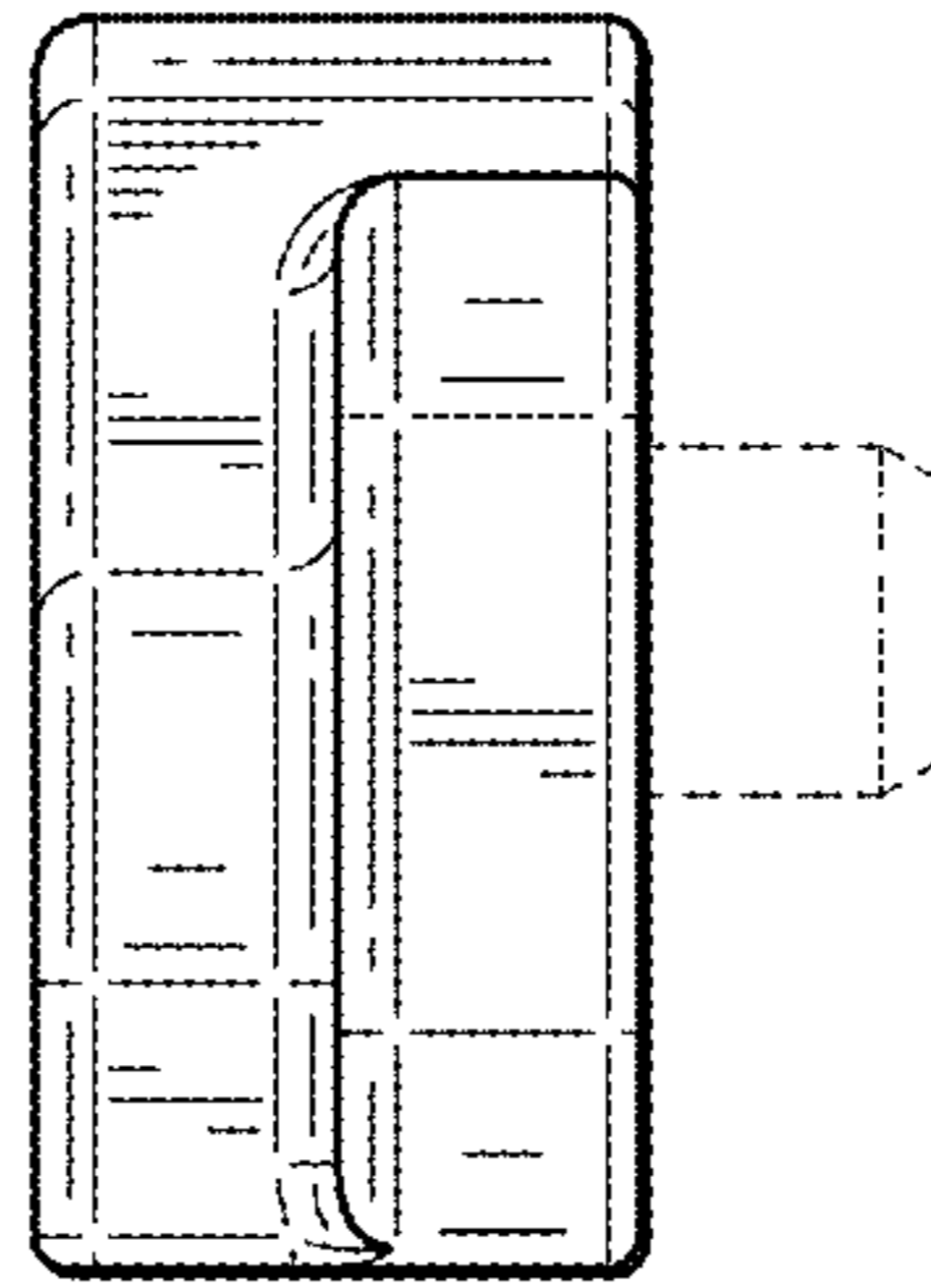

FIG. 4

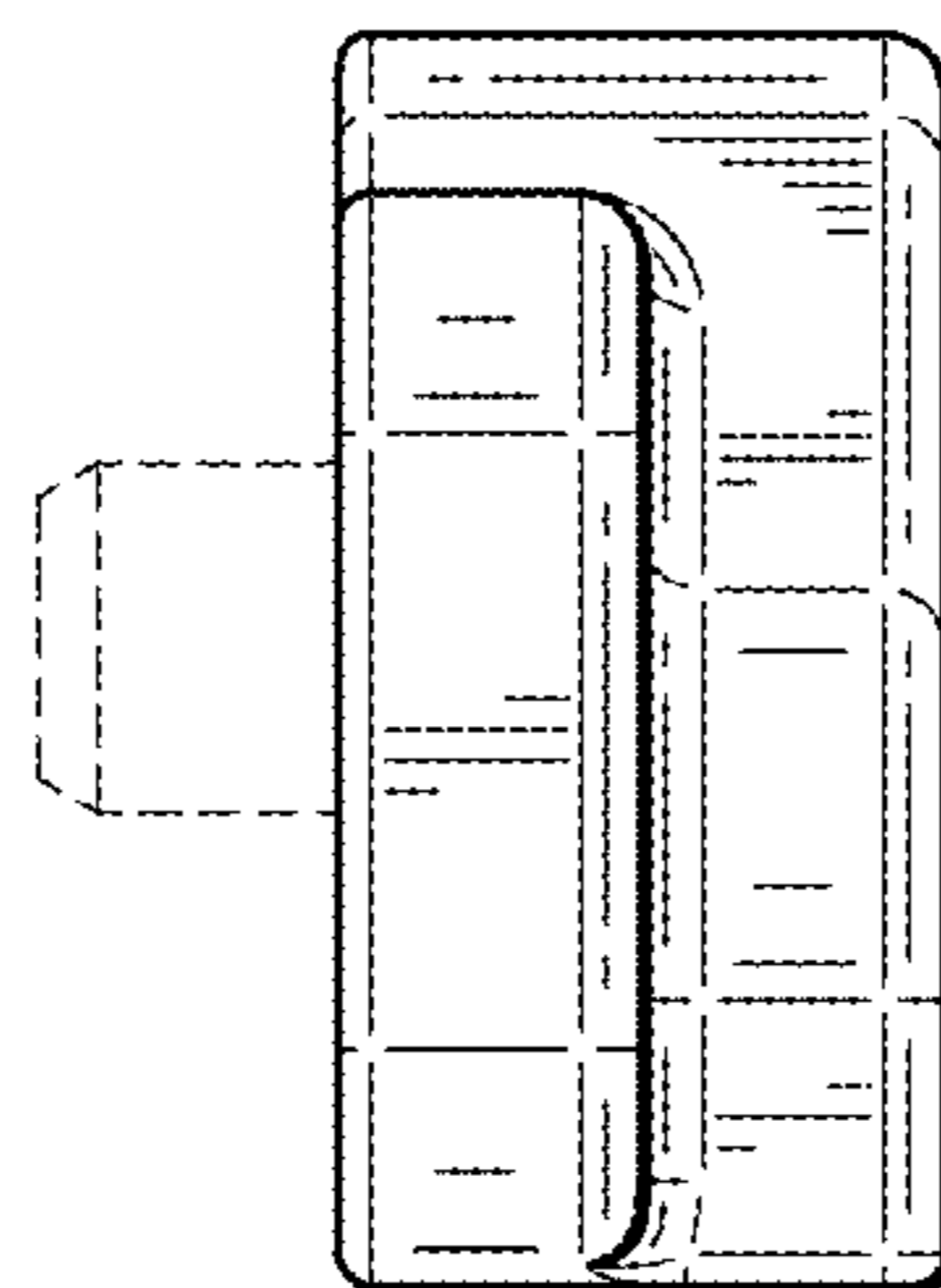

FIG. 5

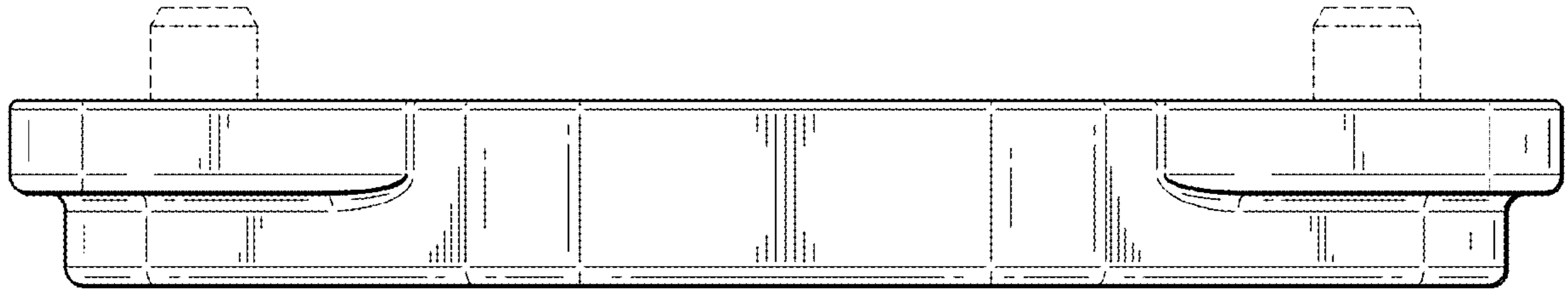

FIG. 6

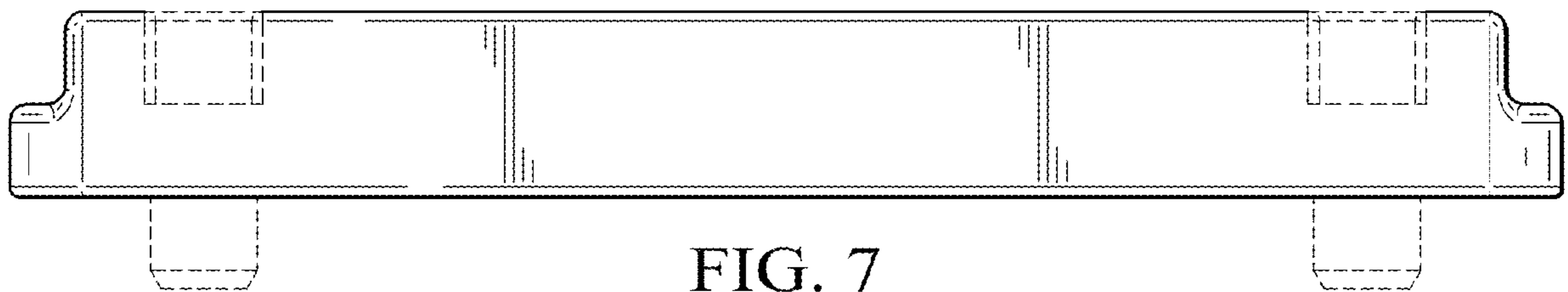

FIG. 7

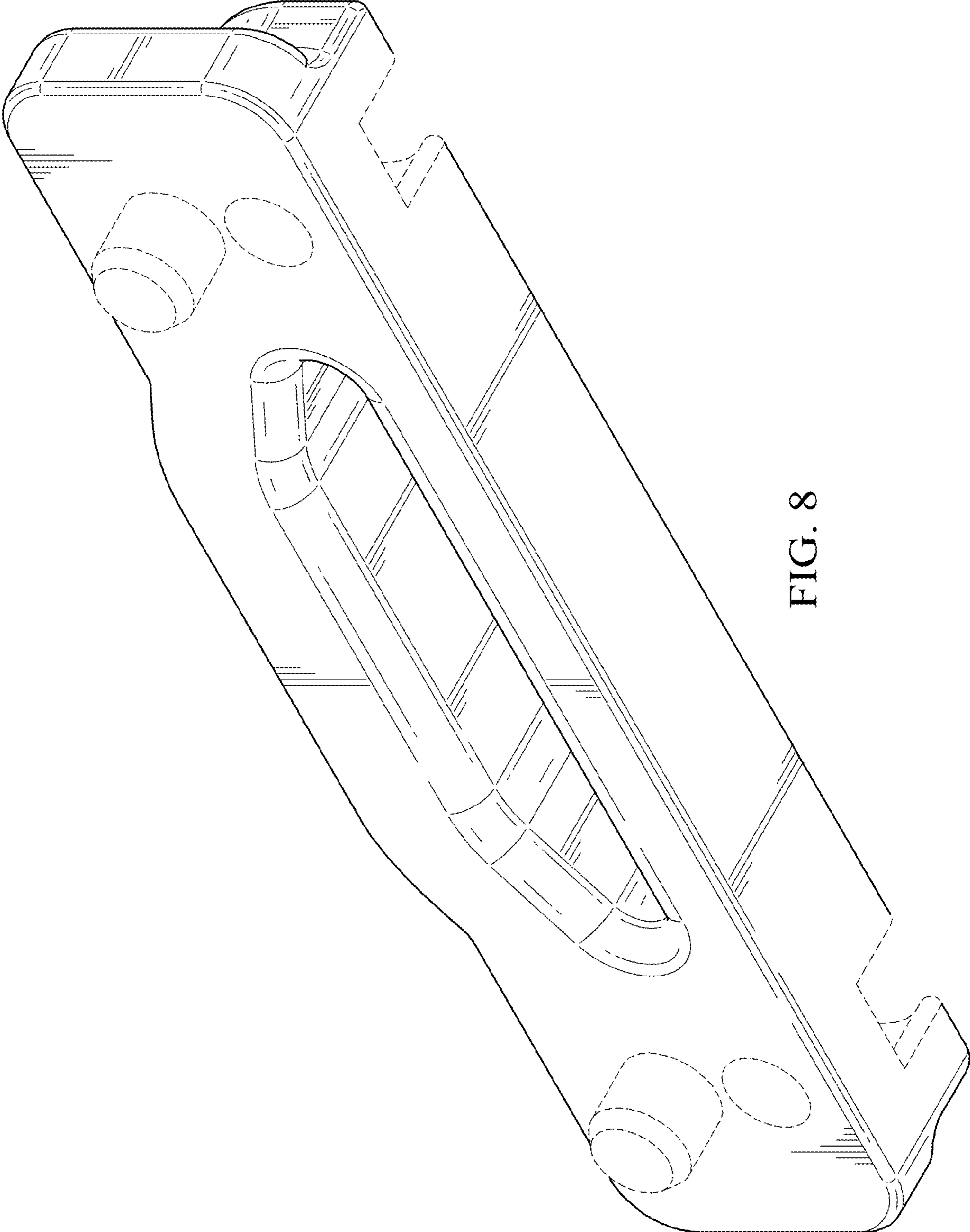

FIG. 8