



US00D946655S

(12) **United States Design Patent**
Cho et al.

(10) **Patent No.:** **US D946,655 S**

(45) **Date of Patent:** **** Mar. 22, 2022**

(54) **ELECTRONIC SHELF LABEL**

(71) Applicant: **SOLUM CO., LTD.**, Yongin-si (KR)

(72) Inventors: **Hyun Hun Cho**, Hwaseong-si (KR);
Yong Bum Lim, Yongin-si (KR); **Mi Deum Choi**, Suwon-si (KR); **Kang Ig Kim**, Hwaseong-si (KR)

(73) Assignee: **SOLUM CO., LTD.**, Yongin-si (KR)

(**) Term: **15 Years**

(21) Appl. No.: **29/733,625**

(22) Filed: **May 5, 2020**

(30) **Foreign Application Priority Data**

Apr. 17, 2020 (KR) 30-2020-0017048

(51) **LOC (13) Cl.** **19-08**

(52) **U.S. Cl.**
USPC **D20/27**; D20/42

(58) **Field of Classification Search**
USPC D10/113.4; D14/125, 126, 371; D20/10,
D20/19, 22, 27, 39, 41, 42, 99
CPC G09F 7/00; G09F 7/02; G09F 7/16; G09F
9/00; G09F 9/3026; G09F 9/33; G09F
9/35; G09F 13/00; G09F 13/22; G09F
15/00; G09F 15/0056; G09F 15/0068;
G06F 3/14; H01R 13/514

See application file for complete search history.

(56) **References Cited**

U.S. PATENT DOCUMENTS

D582,916 S * 12/2008 Wada D14/371
D582,917 S * 12/2008 Wada D14/371
D695,410 S * 12/2013 Becker D24/186
D721,075 S * 1/2015 Toda D14/342
D755,147 S * 5/2016 Lin D14/138 G
D761,901 S * 7/2016 Kim D18/41
D781,800 S * 3/2017 Kluser D14/126
D786,238 S * 5/2017 Roberts D14/341

9,679,310 B1 * 6/2017 Saltzstein G06F 3/043
9,704,466 B2 * 7/2017 Uetabira H04R 1/345
D794,630 S * 8/2017 Pendse D14/341
D801,968 S * 11/2017 Johnson D14/371
10,083,390 B2 * 9/2018 Kim G06K 19/0775
D836,580 S * 12/2018 Ostensen D14/126

(Continued)

FOREIGN PATENT DOCUMENTS

EM 002609727-0001 2/2015

OTHER PUBLICATIONS

E shelf labels, posted at e-shelf-labels.com, posted on Sep. 19, 2020, site visited Nov. 17, 2021. online, available from internet: <https://web.archive.org/web/20200919160747/https://www.e-shelf-labels.com/news/news-about-labels-and-signage/solum-as-new-solution-partner-of-e-shelf-labels.html> (Year: 2020).*

Primary Examiner — Mary Ann Calabrese

Assistant Examiner — Catherine Ho

(74) *Attorney, Agent, or Firm* — Morgan, Lewis & Bockius LLP

(57) **CLAIM**

The ornamental design for an electronic shelf label, as shown and described.

DESCRIPTION

FIG. 1 is a front perspective view of an electronic shelf label showing the new design;
FIG. 2 is a rear perspective view thereof;
FIG. 3 is a front view thereof;
FIG. 4 is a rear view thereof;
FIG. 5 is a left side view thereof;
FIG. 6 is a right side view thereof;
FIG. 7 is a top view thereof; and,
FIG. 8 is a bottom view thereof.

The broken lines in the drawings illustrate unclaimed subject matter and form no part of the claimed design.

1 Claim, 6 Drawing Sheets

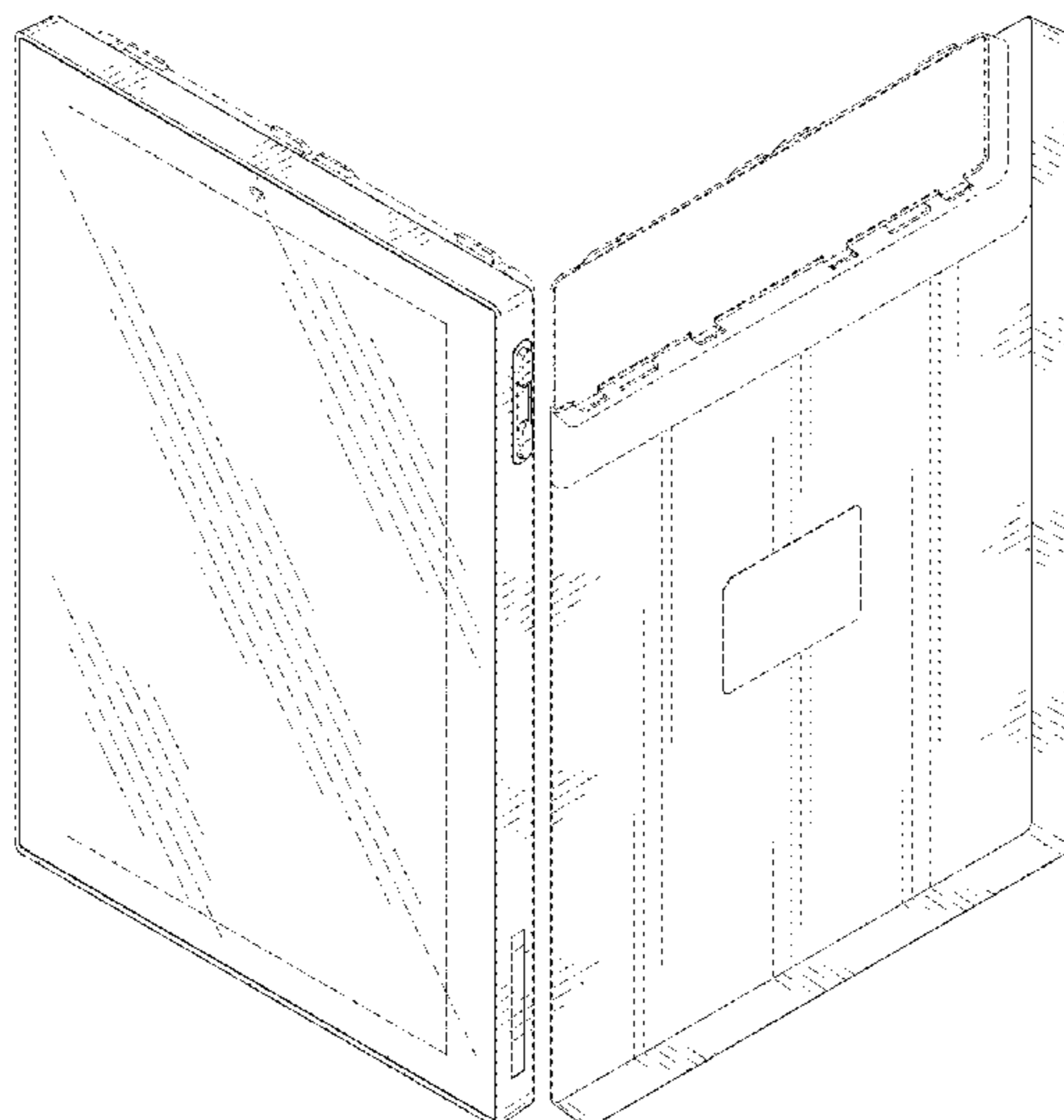

(56)

References Cited

U.S. PATENT DOCUMENTS

D842,857 S * 3/2019 Kimura D14/371
 D852,272 S * 6/2019 Lim D19/113
 D854,429 S * 7/2019 Gentle D10/50
 D862,909 S * 10/2019 Zhou D6/308
 D871,358 S * 12/2019 Kim D14/126
 D874,950 S * 2/2020 Gentle D10/50
 D875,095 S * 2/2020 Gan D14/374
 D876,431 S * 2/2020 Pendse D14/341
 D878,376 S * 3/2020 Claudepierre D14/440
 D882,528 S * 4/2020 Fariello D13/162
 D882,966 S * 5/2020 Jiang D6/308
 D882,967 S * 5/2020 Jiang D6/308
 D893,201 S * 8/2020 Jiang D6/308
 D900,807 S * 11/2020 Nishizawa D14/341
 D901,499 S * 11/2020 Clinton D14/371
 D902,926 S * 11/2020 Andersson D14/371
 D908,122 S * 1/2021 Luo D14/336
 D913,281 S * 3/2021 Kang D14/341
 2011/0239509 A1 * 10/2011 Horikiri G09F 7/08
 40/661.08
 2015/0301778 A1 * 10/2015 Lim G06K 19/07758
 361/679.21
 2016/0260163 A1 * 9/2016 Sjodin G06Q 30/0641

* cited by examiner

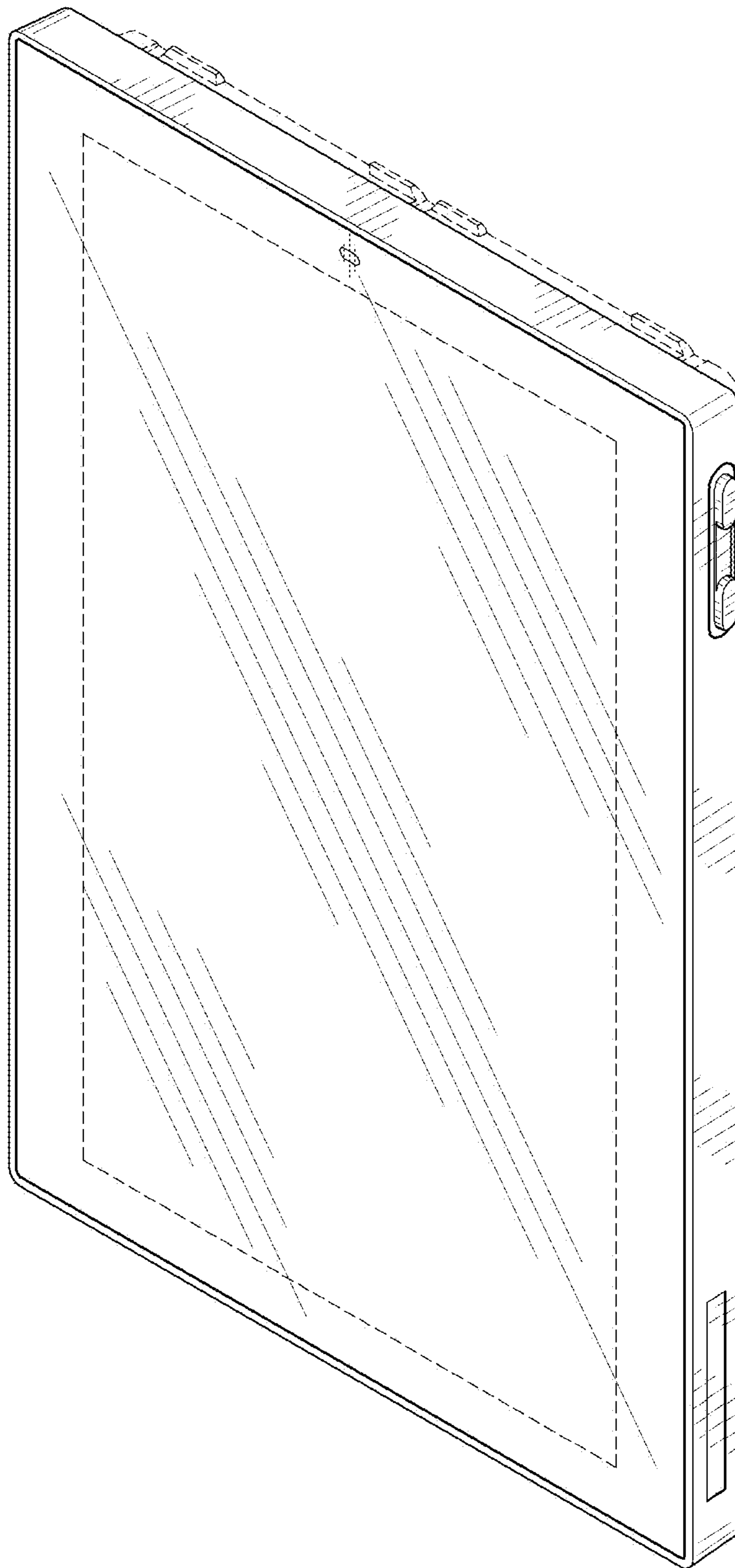

FIG. 1

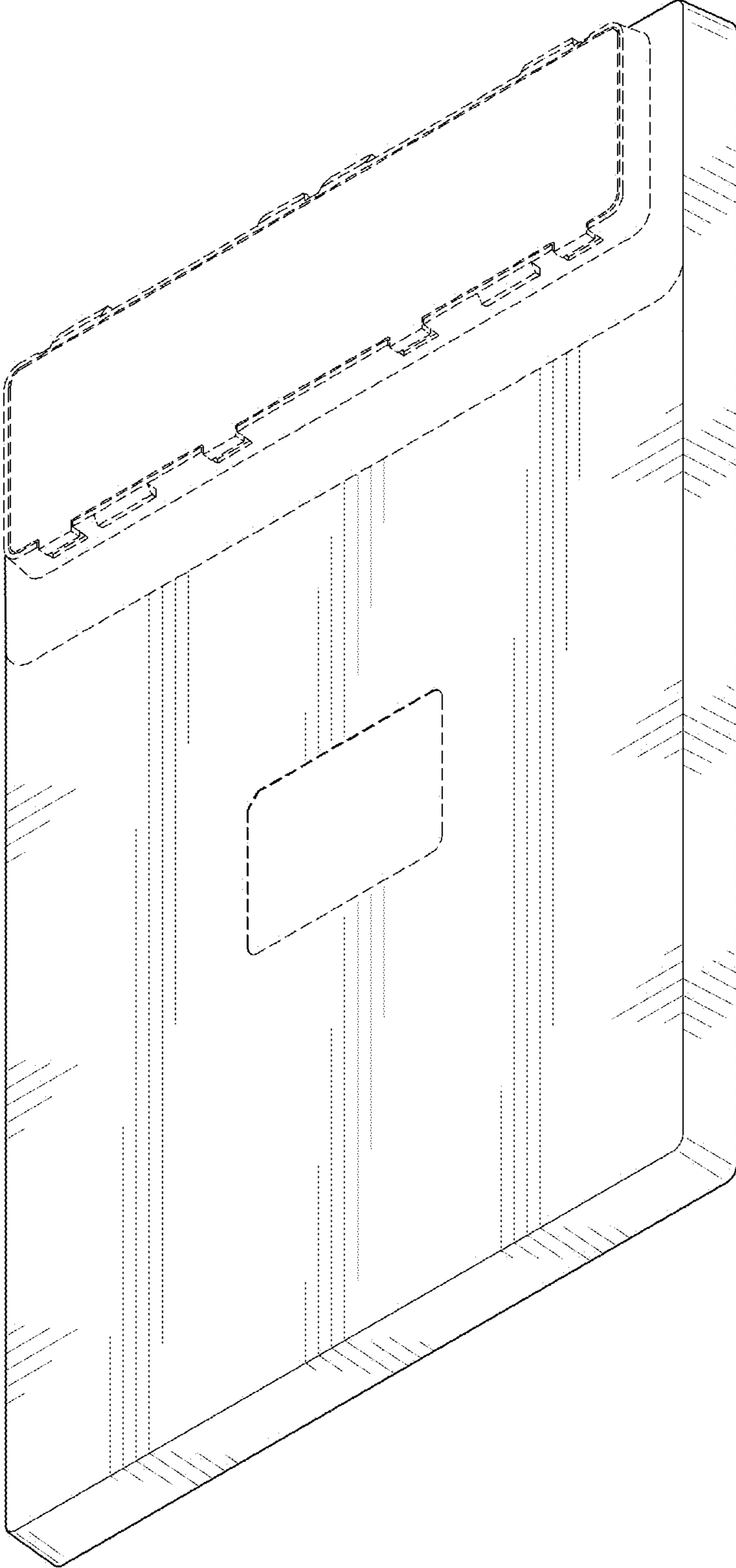

FIG. 2

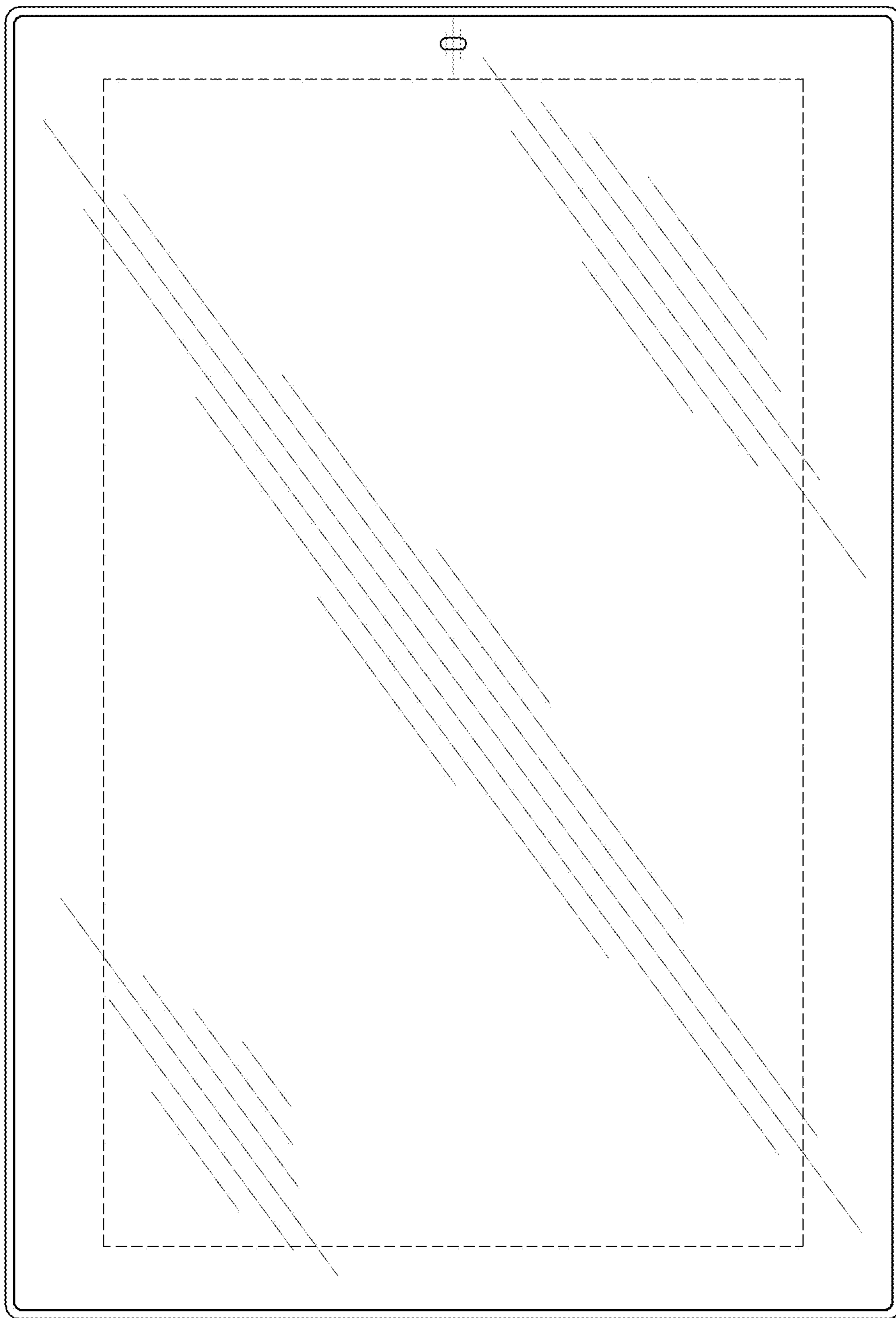

FIG. 3

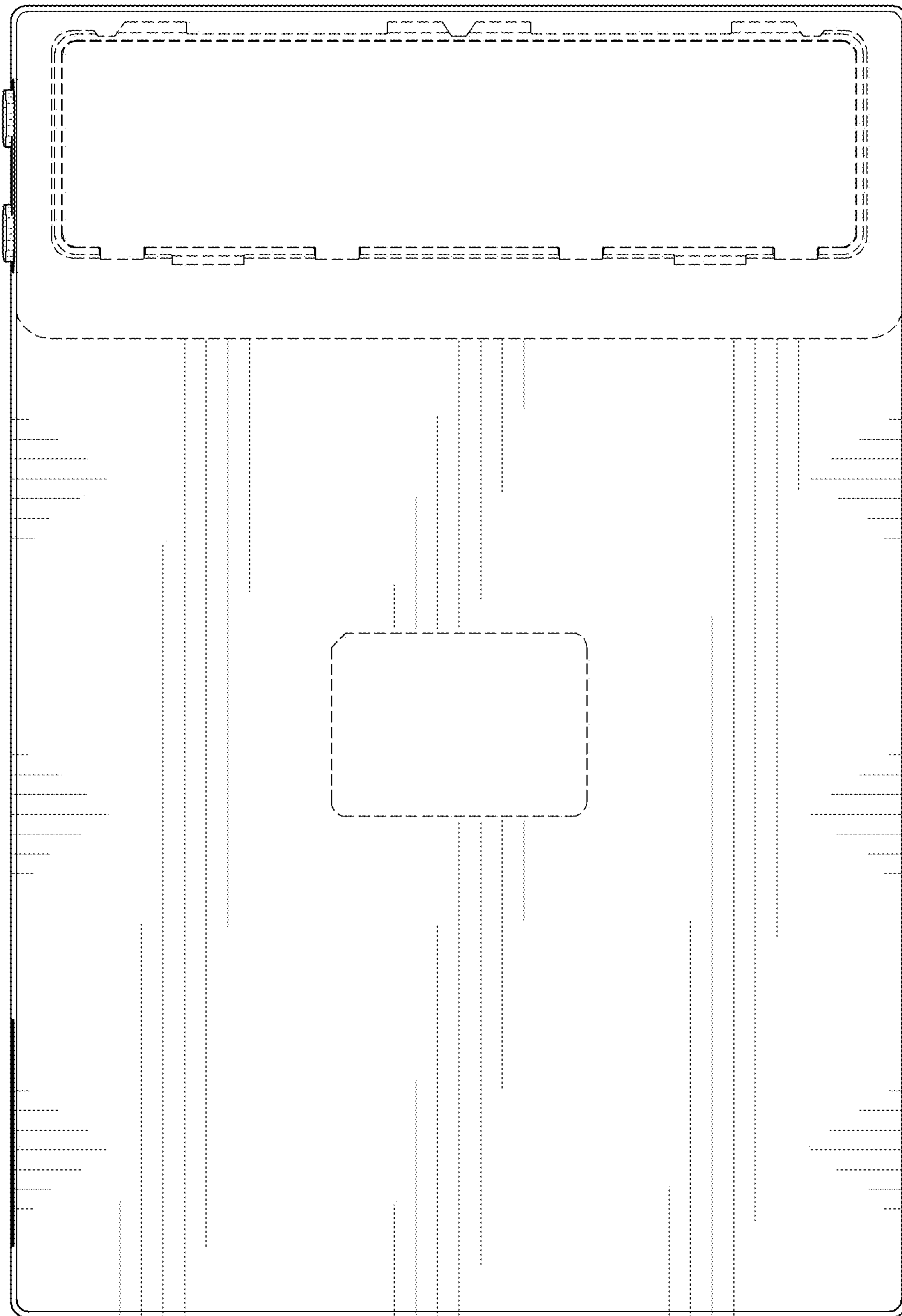

FIG. 4



FIG. 5

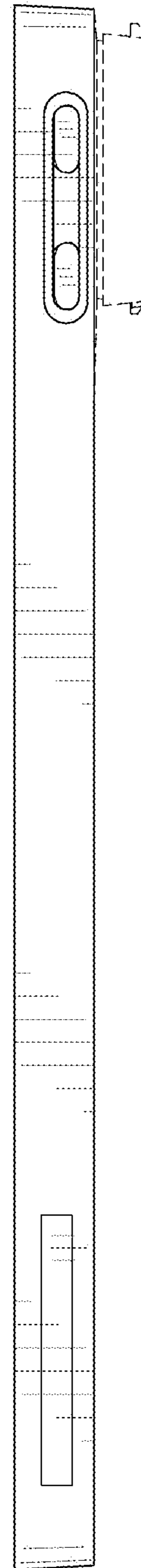

FIG. 6

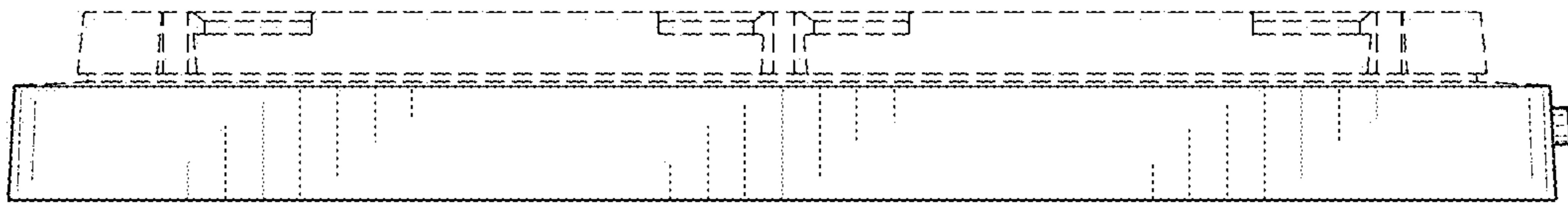

FIG. 7

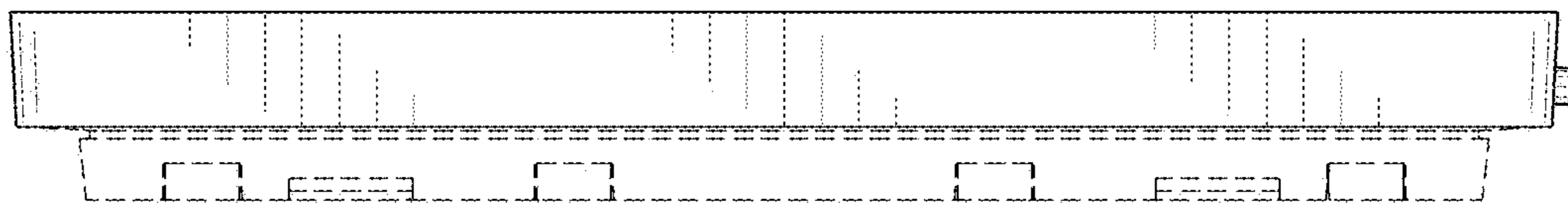

FIG. 8