



US00D946555S

(12) **United States Design Patent**
Chen

(10) **Patent No.:** **US D946,555 S**

(45) **Date of Patent:** **** Mar. 22, 2022**

(54) **WIRELESS EARPHONE**
(71) Applicant: **SHENZHEN SIXPIPES TECHNOLOGY CO., LTD**, Shenzhen (CN)
(72) Inventor: **Guohua Chen**, Shenzhen (CN)
(73) Assignee: **SHENZHEN SIXPIPES TECHNOLOGY CO., LTD**, Shenzhen (CN)
(**) Term: **15 Years**

D566,105 S * 4/2008 Yang D14/223
D572,242 S * 7/2008 Yang D14/223
D575,269 S * 8/2008 Ledbetter D14/205
D583,804 S * 12/2008 Mahler D14/223
D718,284 S * 11/2014 Shibusawa D14/223
D718,286 S * 11/2014 Yang D14/223
D719,548 S * 12/2014 Thompson D14/223
D733,101 S * 6/2015 Pi D14/223
D735,699 S * 8/2015 Yasuda D14/223
D742,860 S * 11/2015 Miyake D14/223
D746,792 S * 1/2016 Kim D14/223
D757,682 S * 5/2016 Perez D14/205
D762,196 S * 7/2016 Hsieh D14/223
D762,616 S * 8/2016 Hsieh D14/223
D773,435 S * 12/2016 Ott D14/223
D775,108 S * 12/2016 Hsieh D14/223

(Continued)

(21) Appl. No.: **29/784,522**
(22) Filed: **May 20, 2021**
(51) **LOC (13) Cl.** **14-01**
(52) **U.S. Cl.**
USPC **D14/223**
(58) **Field of Classification Search**
USPC D14/223, 205; D24/174; 128/864, 865,
128/866; 381/380, 381, 370; 455/90.3,
455/575.1, 569.1
CPC H04R 1/10; H04R 25/00; H04R 25/02;
H04R 1/1066; H04R 1/1016; H04R
5/033; H04R 5/0335; H04R 1/105; H04R
1/1083; H04R 1/1058; H04R 1/20; H04R
1/1091
See application file for complete search history.

FOREIGN PATENT DOCUMENTS

EM 008536924-0002 * 5/2021
EM 008598460-0001 * 7/2021

(Continued)

Primary Examiner — Paula Allen Greene

(57) **CLAIM**

The ornamental design for a wireless earphone, as shown and described.

DESCRIPTION

FIG. 1 is a perspective view of a wireless earphone showing my new design;
FIG. 2 is another perspective view thereof;
FIG. 3 is a front elevational view thereof
FIG. 4 is a rear elevational view thereof;
FIG. 5 is a left side elevational view thereof;
FIG. 6 is a right side elevational view thereof;
FIG. 7 is a top plan view thereof; and,
FIG. 8 is a bottom plan view thereof.
The broken lines in the drawings depict portions of the wireless earphone that form no part of the claimed design.

1 Claim, 8 Drawing Sheets

(56) **References Cited**

U.S. PATENT DOCUMENTS

D353,379 S * 12/1994 Nakamura D14/223
D435,580 S * 12/2000 Grinkus D14/218
D512,049 S * 11/2005 Yang D14/223
D517,054 S * 3/2006 Yang D14/205
D520,497 S * 5/2006 Yang D14/223
D538,784 S * 3/2007 Eklund D14/205
D539,782 S * 4/2007 Lee D14/188
D550,658 S * 9/2007 Wang D14/223

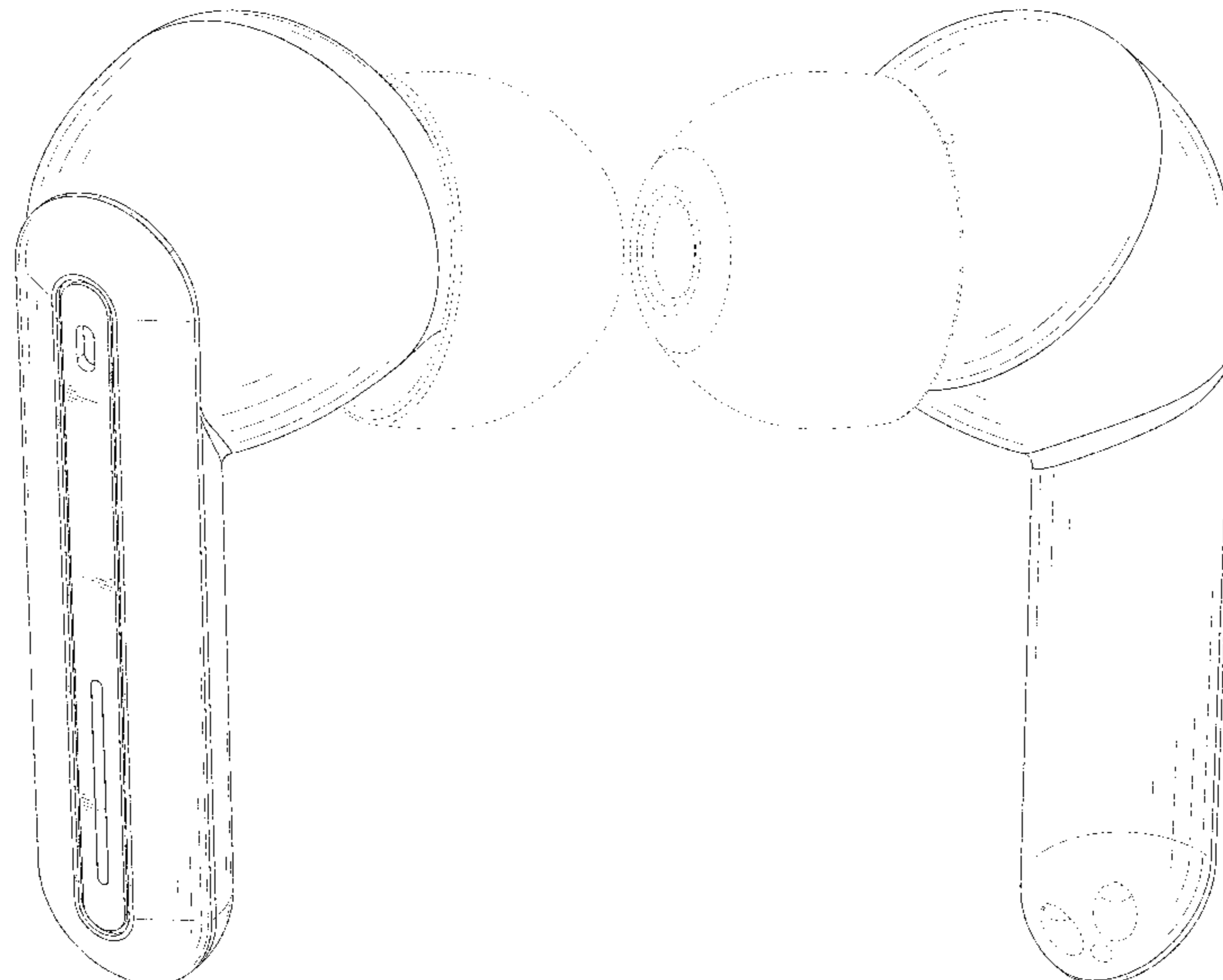

(56)

References Cited

U.S. PATENT DOCUMENTS

D784,298 S * 4/2017 Ozawa D14/223
 D784,962 S * 4/2017 Yang D14/223
 D800,097 S * 10/2017 Chen D14/223
 D801,314 S * 10/2017 Akana D14/223
 D802,562 S * 11/2017 Baba D14/223
 D803,184 S * 11/2017 Loh Jun Kern D14/223
 D813,844 S * 3/2018 Stiff D14/223
 D820,809 S * 6/2018 Akana D14/219
 D822,009 S * 7/2018 Matoba D14/223
 D829,193 S * 9/2018 Cai D14/223
 D830,336 S * 10/2018 Cai D14/205
 D830,345 S * 10/2018 Cai D14/223
 D831,619 S * 10/2018 Matoba D14/223
 D832,823 S * 11/2018 Xiao D14/223
 D847,125 S * 4/2019 Akana D14/206
 D847,794 S * 5/2019 Guo D14/223
 D848,980 S * 5/2019 Kim D14/223
 D848,982 S * 5/2019 Kim D14/223
 D848,983 S * 5/2019 Kim D14/223
 D853,995 S * 7/2019 Cai D14/223
 D861,647 S * 10/2019 Chen D14/223
 D864,165 S * 10/2019 Roberts D14/223
 D864,169 S * 10/2019 Min D14/223
 D869,445 S * 12/2019 Hu D14/223
 D871,376 S * 12/2019 Zhou D14/223
 D873,805 S * 1/2020 Yang D14/223
 D877,722 S * 3/2020 Yang D14/223
 D878,337 S * 3/2020 Yang D14/223
 D883,260 S * 5/2020 Hu D14/223
 D884,682 S * 5/2020 Du D14/223
 D885,373 S * 5/2020 Lundbäck D14/223
 D887,396 S * 6/2020 Wang D14/223
 D888,690 S * 6/2020 Yan D14/223
 D888,691 S * 6/2020 Liu D14/223
 D889,436 S * 7/2020 Zhang D14/206
 D889,437 S * 7/2020 Ando D14/223
 D890,138 S * 7/2020 Peng D14/223

D890,724 S * 7/2020 Li D14/223
 D893,462 S * 8/2020 Liu D14/223
 D895,579 S * 9/2020 Yang D14/223
 D895,582 S * 9/2020 Wu D14/223
 D896,206 S * 9/2020 Xu D14/223
 D896,207 S * 9/2020 He D14/223
 D897,319 S 9/2020 Wang
 D897,997 S * 10/2020 Zhang D14/223
 D897,998 S * 10/2020 Ma D14/223
 D903,639 S * 12/2020 Yang D14/223
 D905,018 S * 12/2020 Zhu D14/223
 D907,008 S * 1/2021 Yao D14/223
 D910,600 S * 2/2021 Zhang D14/223
 D911,315 S * 2/2021 Hutchison D14/223
 D914,647 S * 3/2021 Yang D14/223
 D914,648 S * 3/2021 Zhou D14/223
 D914,649 S * 3/2021 Chen D14/223
 D914,652 S * 3/2021 Chen D14/223
 D916,684 S * 4/2021 Fang D14/223
 D918,182 S * 5/2021 Chen D14/223
 D920,293 S * 5/2021 Chen D14/223
 D924,851 S * 7/2021 Li D14/223
 D925,500 S * 7/2021 Chen D14/223
 D929,379 S * 8/2021 Woo D14/223
 D929,380 S * 8/2021 Park D14/223
 D934,839 S * 11/2021 Zhong D14/223
 D935,446 S * 11/2021 Yi D14/223
 D940,692 S * 1/2022 Quan D14/223
 2017/0026738 A1 * 1/2017 Tang H04R 1/1091
 2020/0068283 A1 * 2/2020 Chou H04R 1/1075
 2020/0177986 A1 * 6/2020 Wen G10K 11/17857
 2020/0252715 A1 * 8/2020 Zhou H04R 1/1041
 2020/0314527 A1 * 10/2020 Guo H04R 15/00
 2021/0014603 A1 * 1/2021 Wei H04R 5/04

FOREIGN PATENT DOCUMENTS

EM 008719041-0002 * 10/2021
 JP D1701464 * 11/2021

* cited by examiner

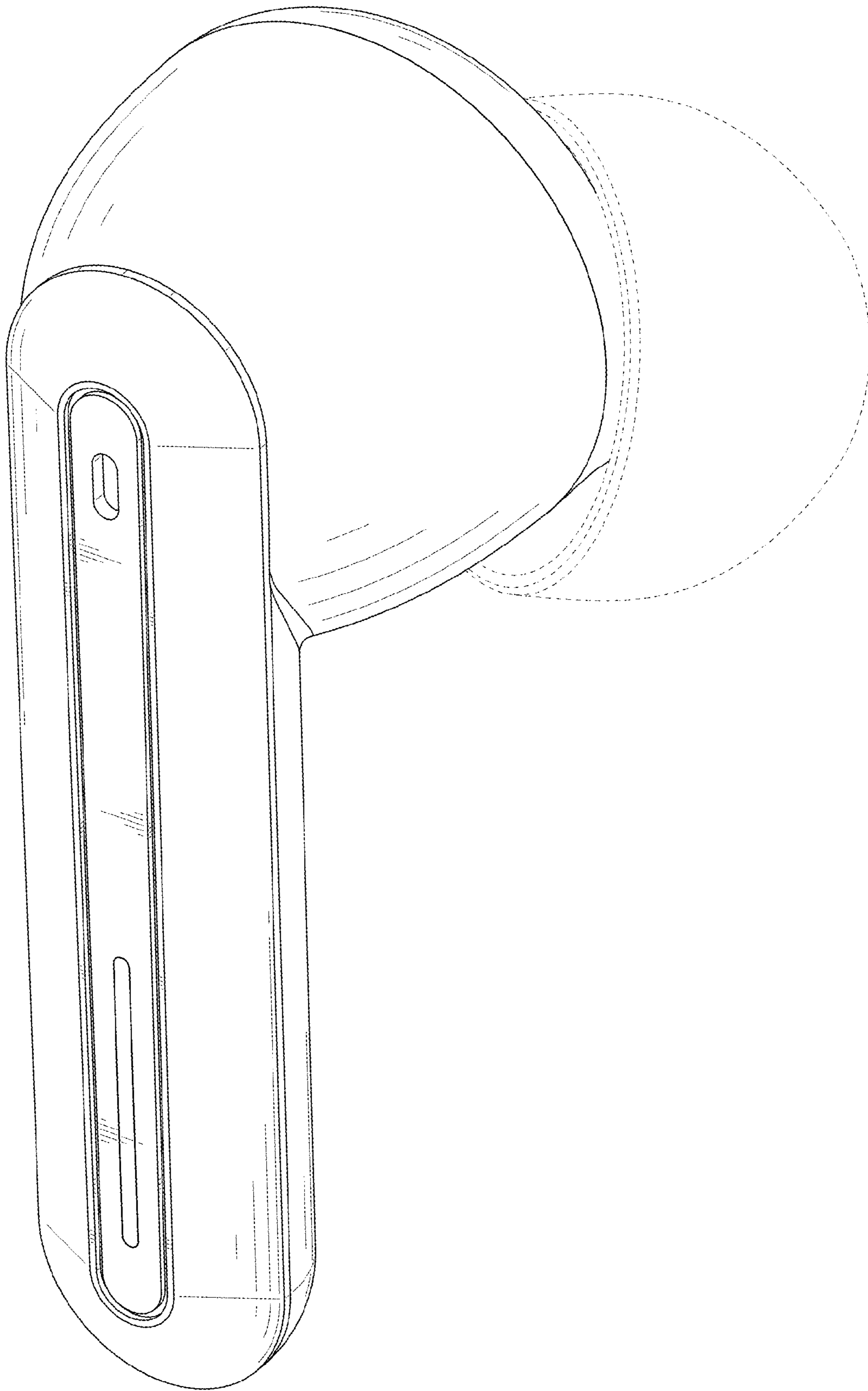

FIG. 1

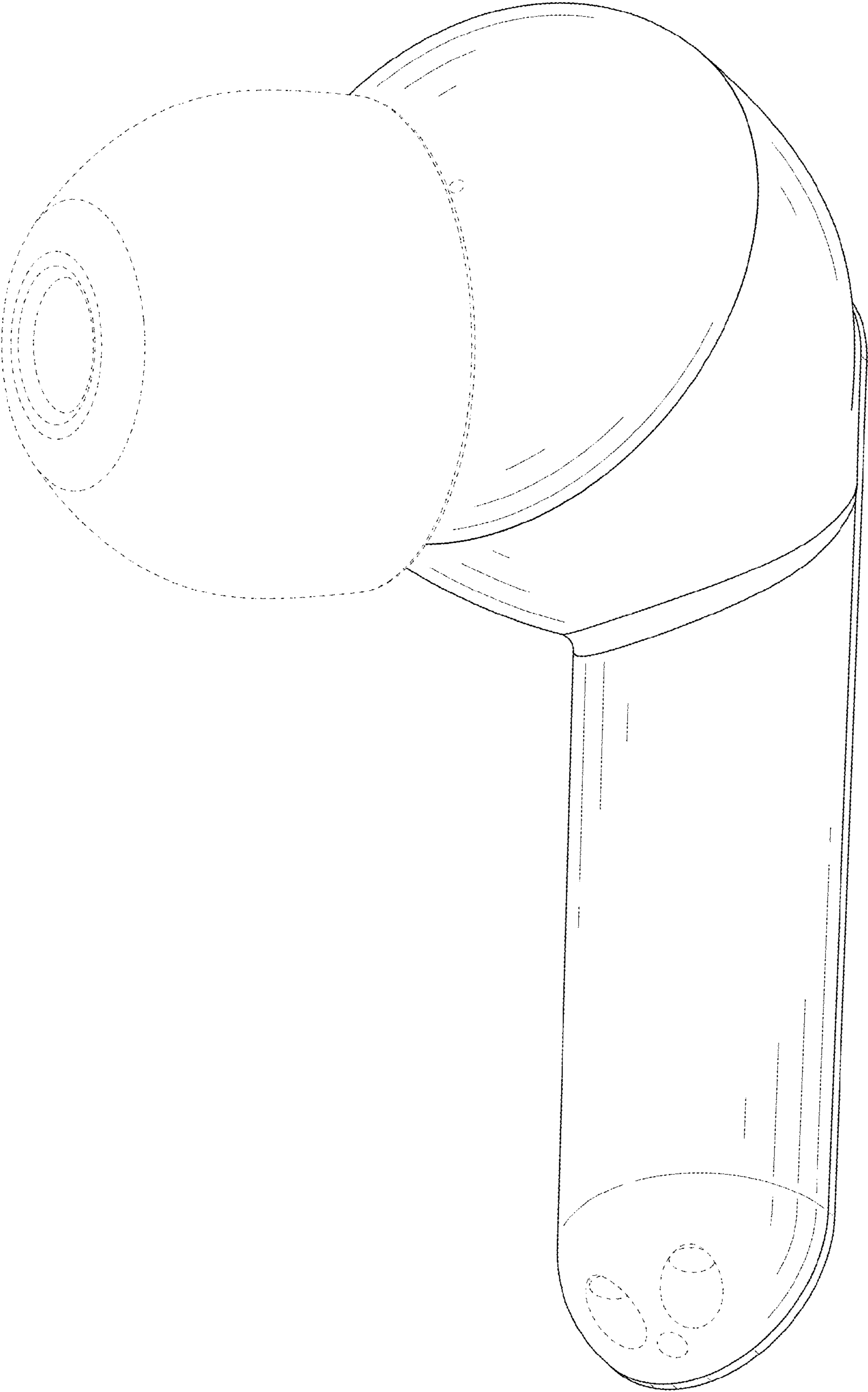

FIG. 2

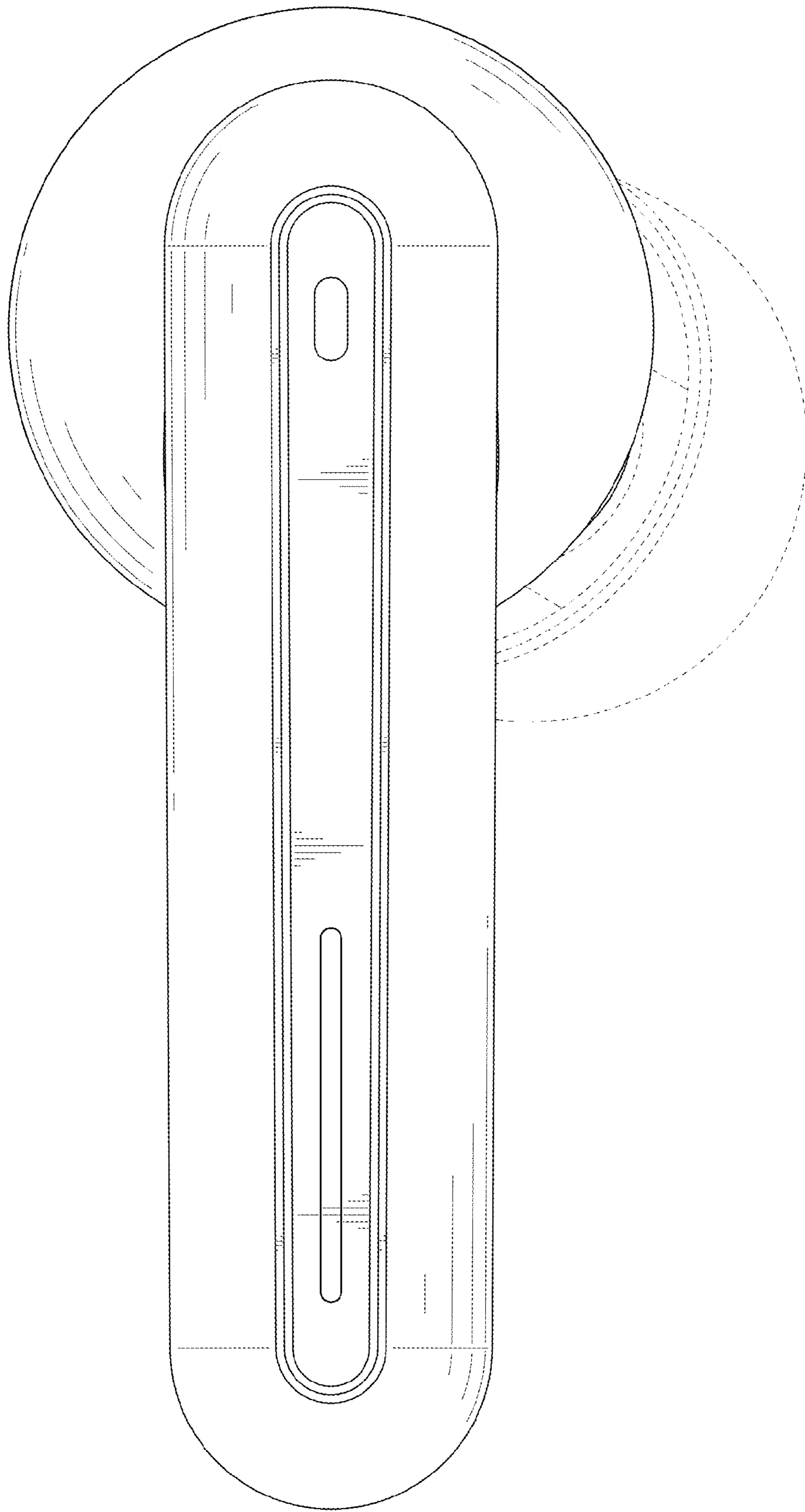

FIG. 3

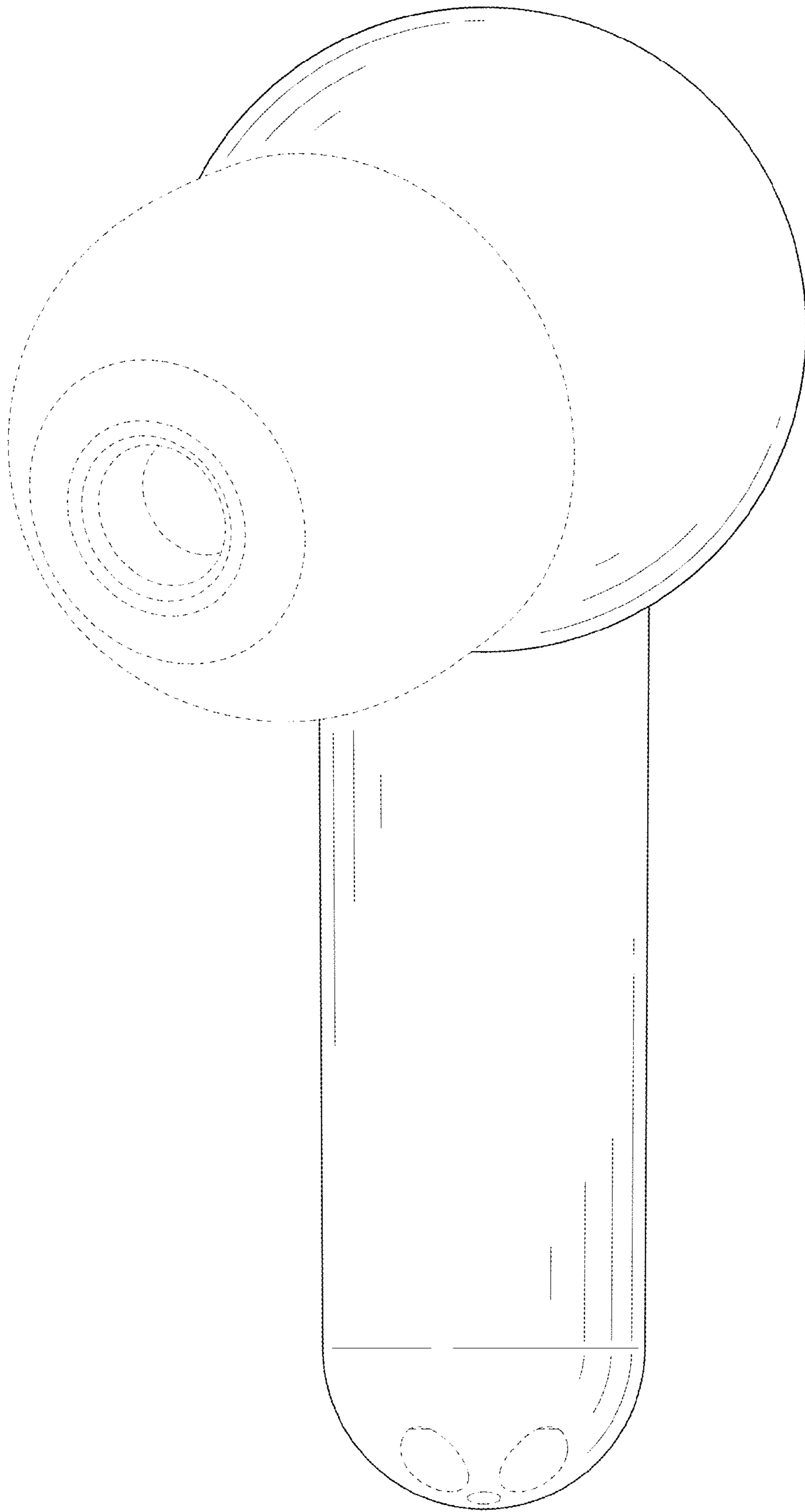

FIG. 4

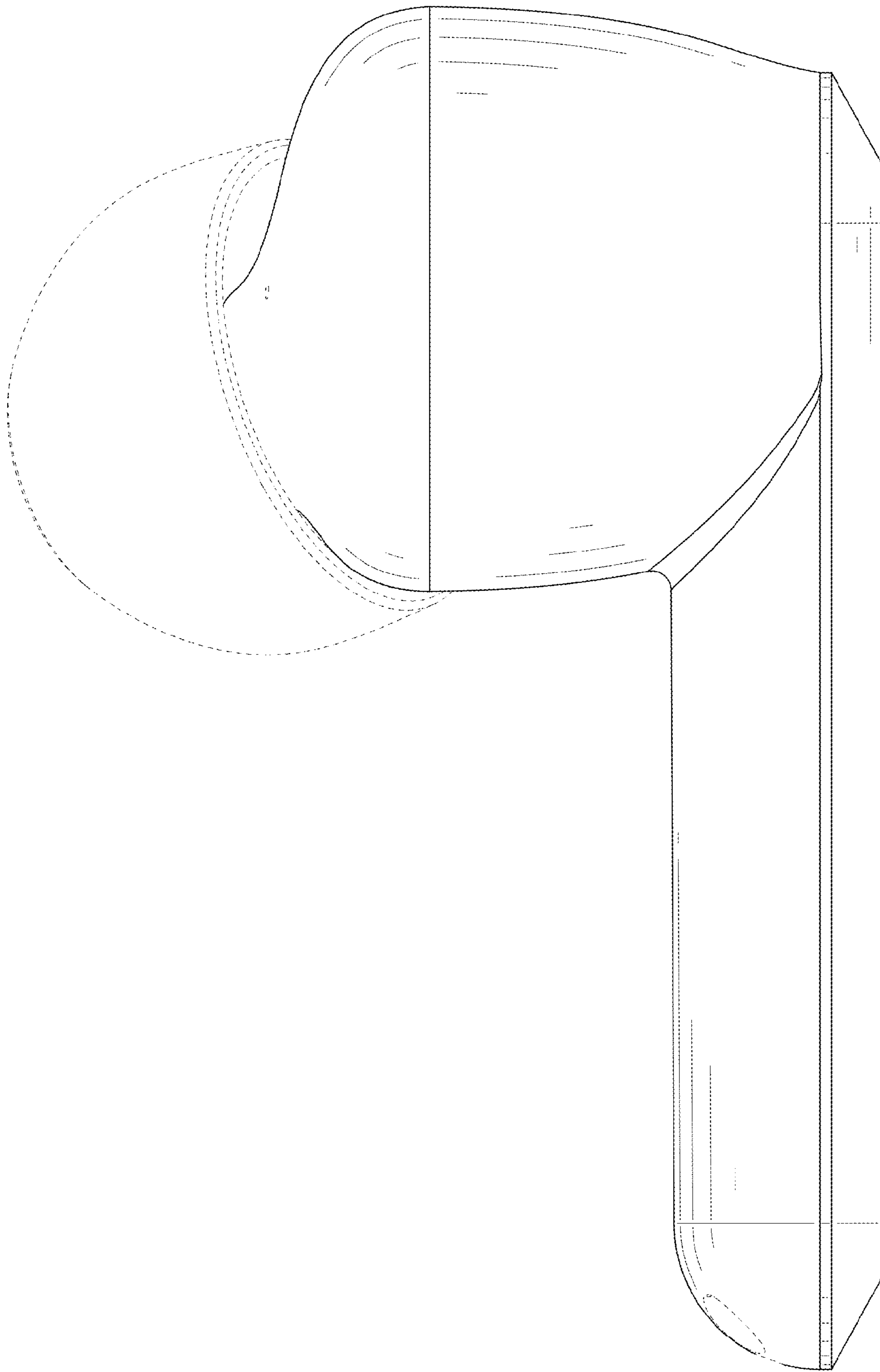

FIG. 5

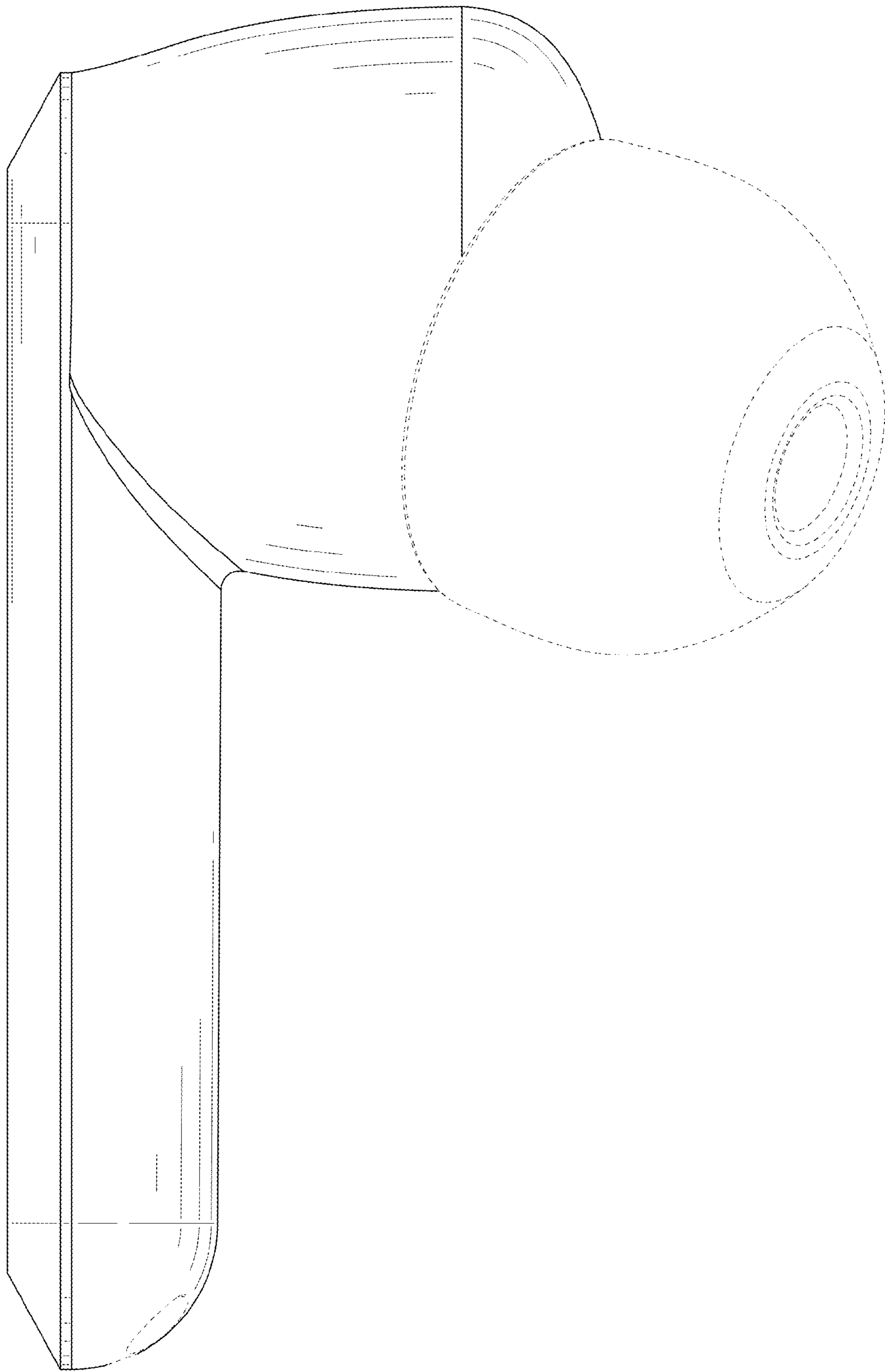

FIG. 6

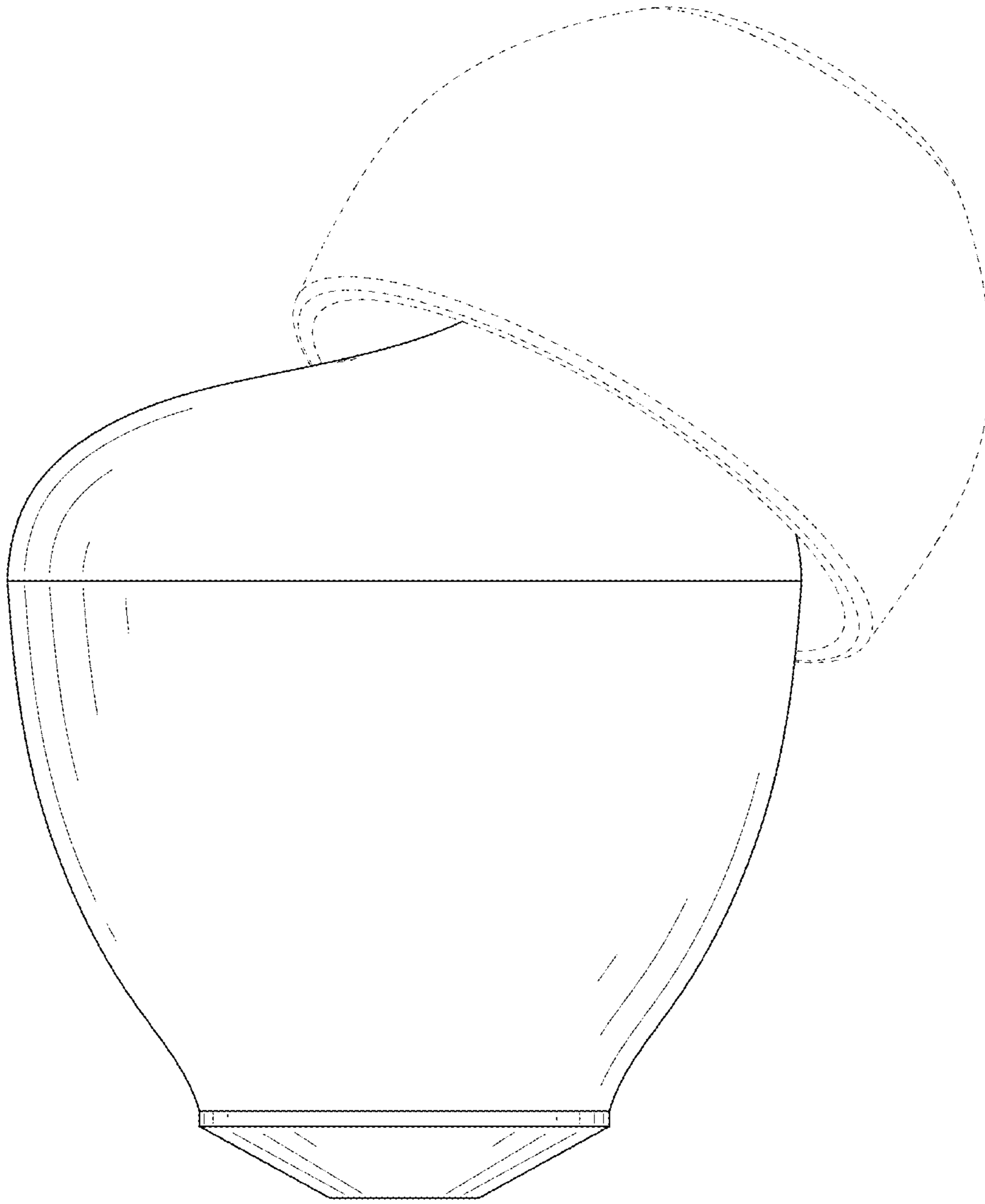

FIG. 7

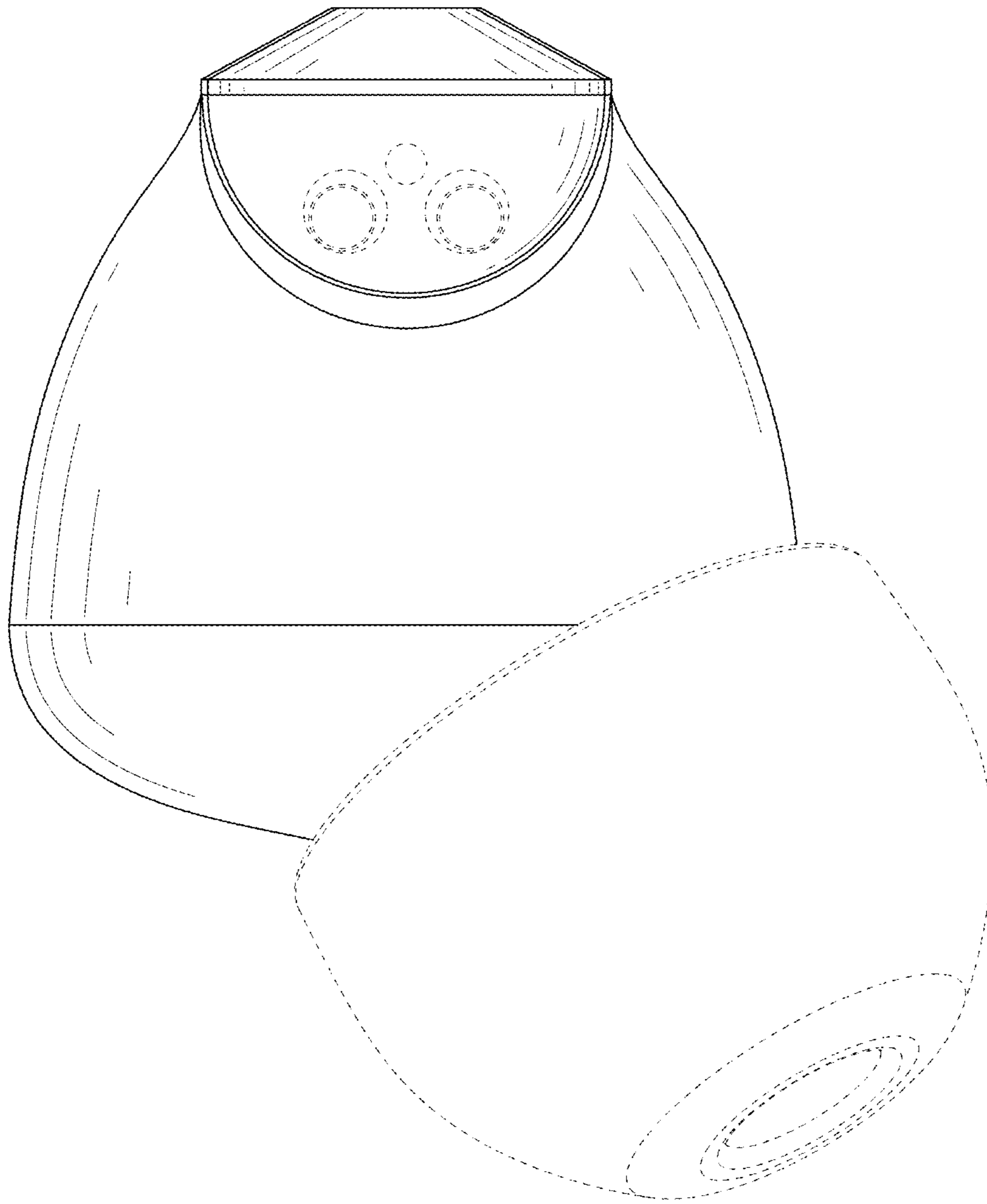

FIG. 8