



US00D946548S

(12) **United States Design Patent**
Kim et al.

(10) **Patent No.:** **US D946,548 S**
(45) **Date of Patent:** **** Mar. 22, 2022**

(54) **ELECTRONIC DEVICE**
(71) Applicant: **Samsung Electronics Co., Ltd.**,
Suwon-si (KR)
(72) Inventors: **In-Shik Kim**, Suwon-si (KR); **Yun-Jin Kim**,
Suwon-si (KR); **Nam-Kyu Kim**,
Suwon-si (KR); **Hae-Sung Park**,
Suwon-si (KR)

D856,958 S * 8/2019 Seo D14/138 G
D856,959 S * 8/2019 Seo D14/138 G
D859,345 S * 9/2019 Seo D14/138 G
D860,150 S * 9/2019 Seo D14/138 G
D872,042 S * 1/2020 Seo D14/138 G
D872,043 S * 1/2020 Seo D14/138 G
D872,703 S * 1/2020 Seo D14/138 G
D873,230 S * 1/2020 Seo D14/138 G

(Continued)

(73) Assignee: **SAMSUNG ELECTRONICS CO., LTD.**,
Suwon-si (KR)

FOREIGN PATENT DOCUMENTS
GB 8205573000-1000 * 12/2019
GB 8206124000-2000 * 1/2020

(**) Term: **15 Years**

OTHER PUBLICATIONS

(21) Appl. No.: **29/748,354**

Samsung Galaxy A51, www.amazon.com, Dec. 20, 2019. <https://www.amazon.com/Samsung-Galaxy-SM-A515F-DS-Unlocked/dp/B082YG1L4B/> (Year: 2019).*

(22) Filed: **Aug. 28, 2020**

(30) **Foreign Application Priority Data**

Jul. 24, 2020 (KR) 30-2020-0034452

(51) **LOC (13) Cl.** **14-03**

(52) **U.S. Cl.**
USPC **D14/138 G**

(58) **Field of Classification Search**
USPC D14/138 R, 496, 138 G, 138 C, 138 AD,
D14/138 AC, 138 AB, 138 AA, 248,
D14/203.1, 203.3, 203.4, 203.7, 388, 389,
D14/439, 426, 348.3, 42, 341; D13/107,
D13/103; D21/329; D10/50
CPC G06F 3/041; G06F 3/0412; G06F 3/0488;
G06F 3/04883; G06F 1/1613; G06F
1/1692; G06F 1/1626; G06F 2200/1633;
A63H 33/3016

See application file for complete search history.

(56) **References Cited**

U.S. PATENT DOCUMENTS

D803,779 S * 11/2017 Jung D13/107
D831,605 S * 10/2018 Baik D14/138 G
D839,848 S * 2/2019 Baik D14/138 G

Primary Examiner — Llorelys Martinez
Assistant Examiner — Kwabena A. Ankobiah
(74) Attorney, Agent, or Firm — McAndrews Held & Malloy, Ltd.

(57) **CLAIM**

The ornamental design for an electronic device, as shown and described.

DESCRIPTION

FIG. 1 is a front perspective view of an electronic device showing our new design;
FIG. 2 is a front elevation view thereof;
FIG. 3 is a rear elevation view thereof;
FIG. 4 is a left side elevation view thereof;
FIG. 5 is a right side elevation view thereof;
FIG. 6 is a top plan view thereof;
FIG. 7 is a bottom plan view thereof; and,
FIG. 8 is a rear perspective view thereof.
The broken lines in the figures illustrate portions of the electronic device that form no part of the claimed design.

1 Claim, 8 Drawing Sheets

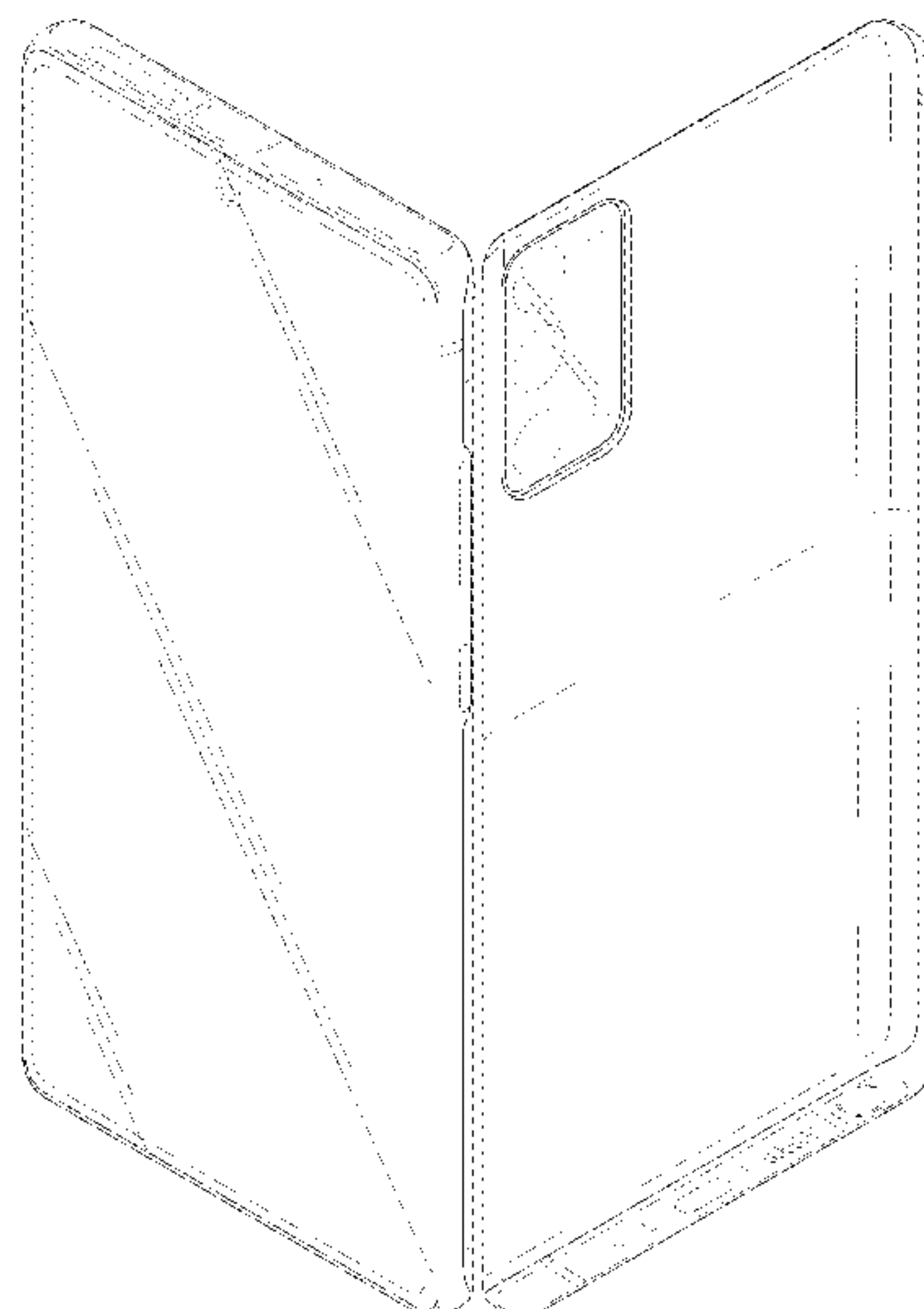

(56)

References Cited

U.S. PATENT DOCUMENTS

D875,700	S	*	2/2020	Seo	D14/138	G
D889,425	S	*	7/2020	Choi	D14/138	G
D919,589	S	*	5/2021	Ji	D14/138	G
D924,828	S	*	7/2021	Oh	D14/138	G
D929,356	S	*	8/2021	Kim	D14/138	G
D939,485	S	*	12/2021	Kim	D14/248	
D939,486	S	*	12/2021	Kim	D14/248	
D939,487	S	*	12/2021	Kim	D14/248	

* cited by examiner

FIG. 1

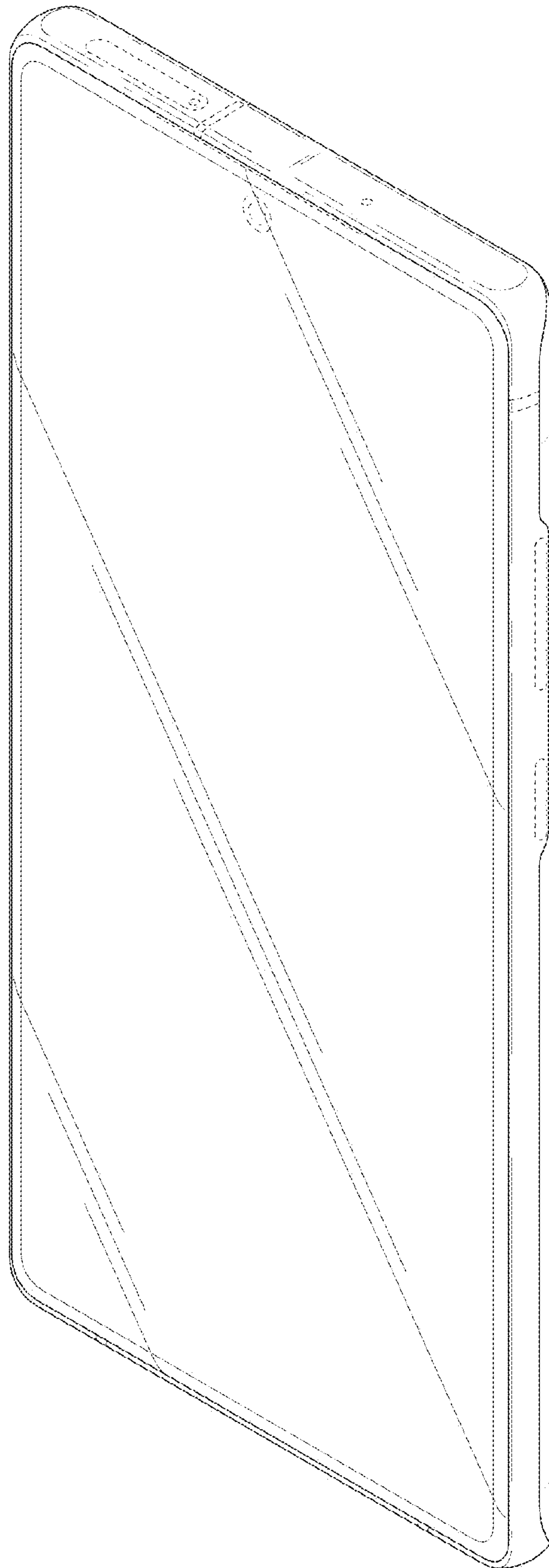

FIG. 2

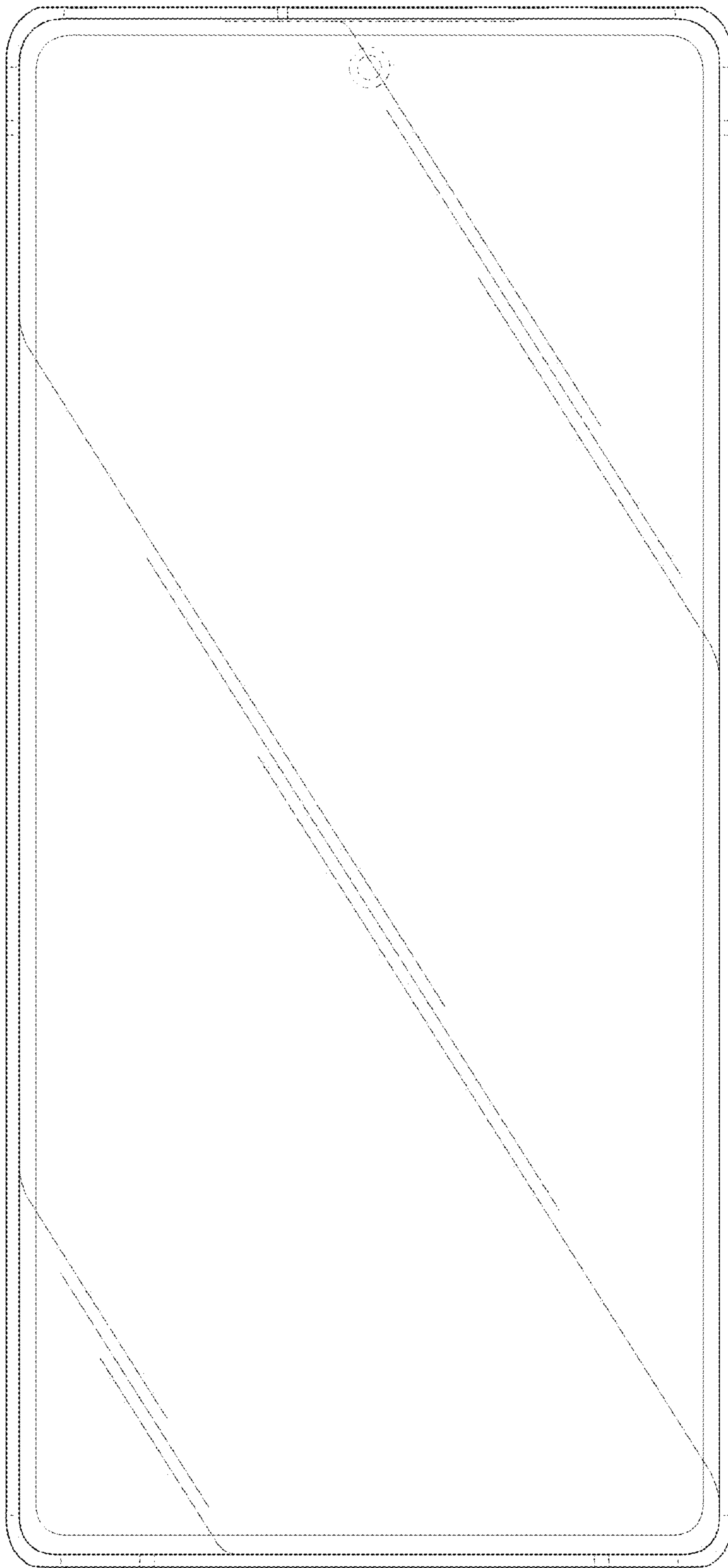

FIG. 3

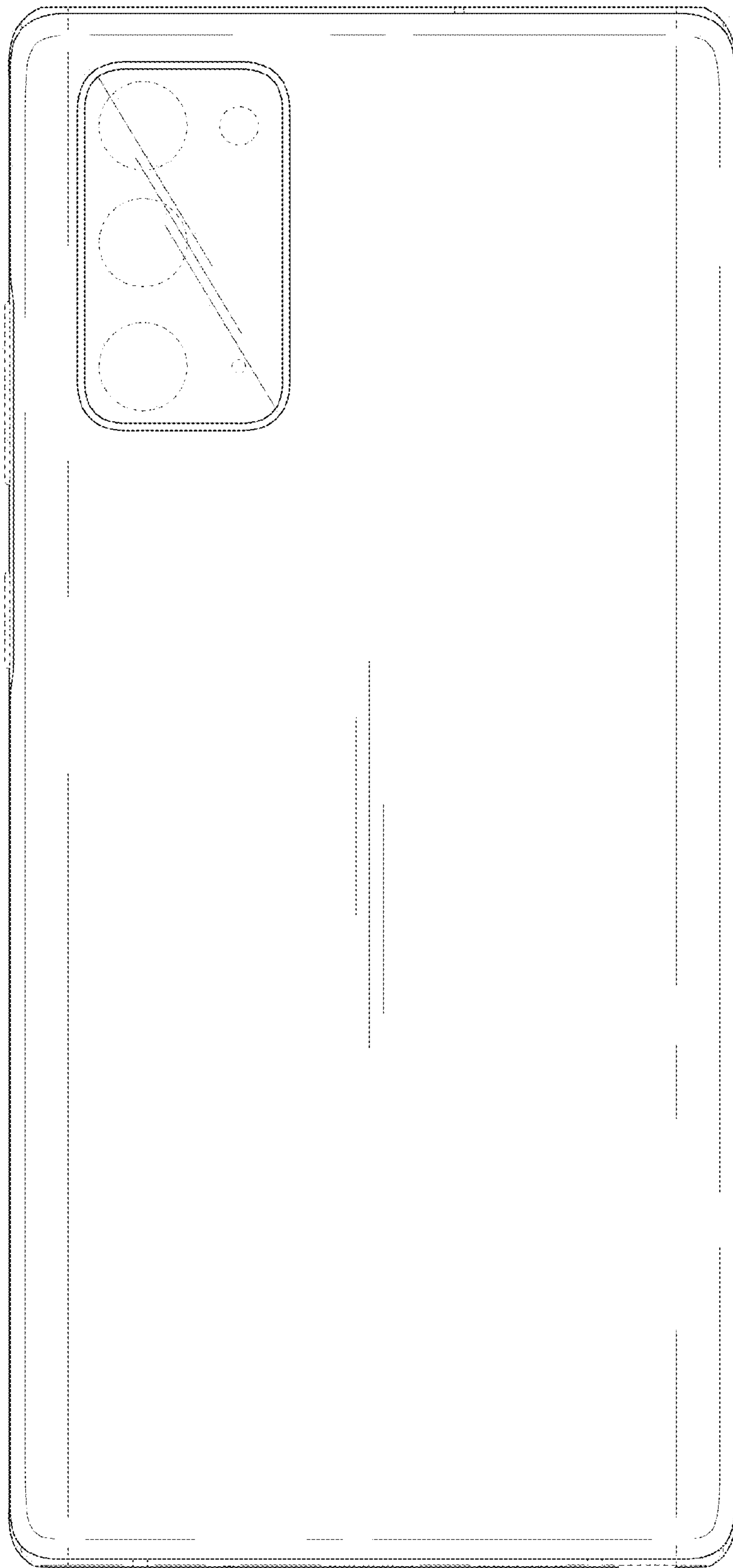

FIG. 4

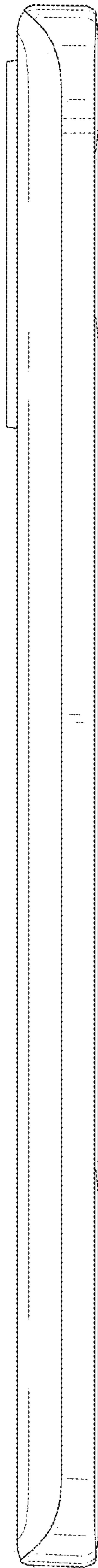

FIG. 5

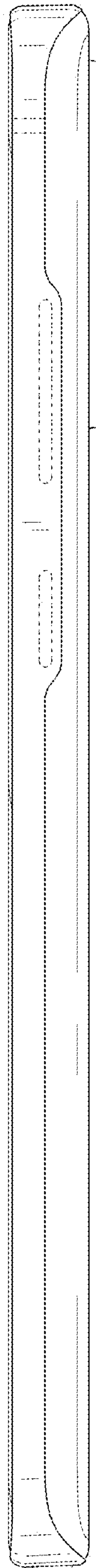

FIG. 6

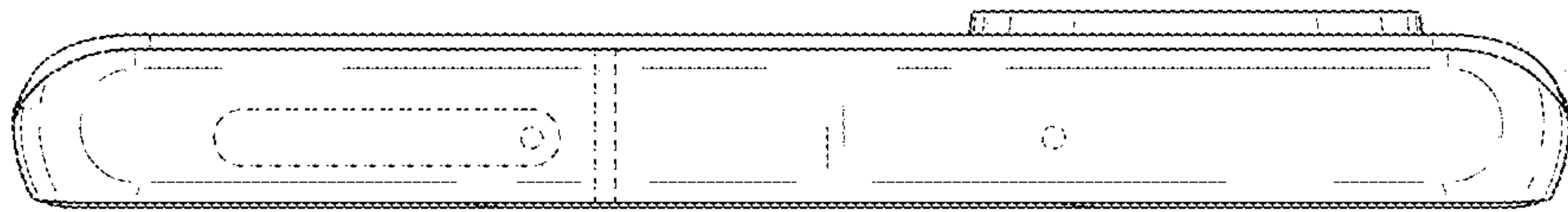

FIG. 7

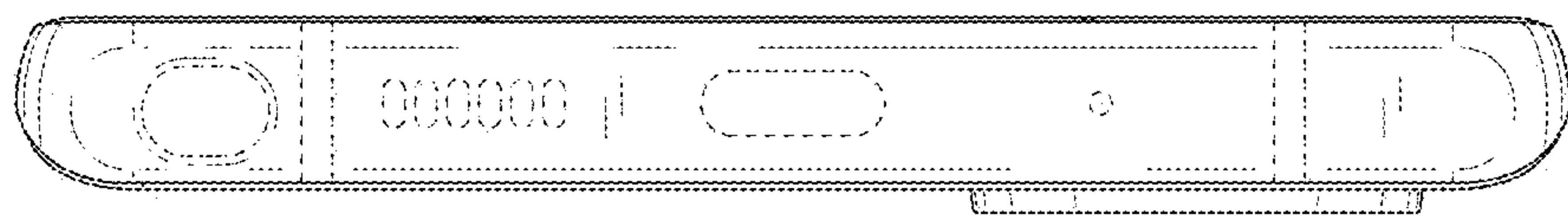

FIG. 8

