



US00D946486S

(12) **United States Design Patent**
Lee

(10) **Patent No.:** **US D946,486 S**
(45) **Date of Patent:** **** Mar. 22, 2022**

(54) **AUTOMOTIVE WHEEL**

(71) Applicant: **Angela Lee**, Chicago, IL (US)

(72) Inventor: **Angela Lee**, Chicago, IL (US)

(**) Term: **15 Years**

(21) Appl. No.: **29/700,740**

(22) Filed: **Aug. 5, 2019**

(51) **LOC (13) Cl.** **12-16**

(52) **U.S. Cl.**
USPC **D12/211**

(58) **Field of Classification Search**
USPC D12/204–213; D21/563
CPC B60B 7/00; B60B 7/02; B60B 7/04; B60B
7/01; B60B 7/06; B60B 3/02; B60B 3/04;
B60B 3/06; B60B 3/10; B60B 1/00;
B60B 1/08; B60B 1/10; B60B 1/12
See application file for complete search history.

(56) **References Cited**

U.S. PATENT DOCUMENTS

| | | | |
|--------------|---------|------------|---------|
| D339,561 S * | 9/1993 | Maiworm | D12/211 |
| D450,649 S * | 11/2001 | Penzes | D12/211 |
| D520,435 S * | 5/2006 | Kulla | D12/211 |
| D593,474 S * | 6/2009 | Flueckiger | D12/209 |
| D596,548 S * | 7/2009 | Gallert | D12/211 |
| D610,516 S * | 2/2010 | Dilber | D12/211 |
| D632,239 S * | 2/2011 | Gallert | D12/211 |
| D638,766 S * | 5/2011 | Hilpert | D12/211 |
| D655,663 S * | 3/2012 | Zhao | D12/211 |

| | | | |
|-----------------|---------|----------------|-----------|
| D658,105 S * | 4/2012 | Hans | D12/211 |
| D688,190 S * | 8/2013 | Hodges | D12/211 |
| D695,194 S * | 12/2013 | Kong | D12/211 |
| D744,931 S * | 12/2015 | Curic | D12/211 |
| D755,690 S * | 5/2016 | von Tardy-Tuch | D12/209 |
| D766,155 S * | 9/2016 | Wheel | D12/211 |
| D768,047 S * | 10/2016 | Hans | D12/211 |
| 10,357,993 B2 * | 7/2019 | Muller | B60B 1/12 |
| D863,182 S * | 10/2019 | Han | D12/209 |
| D867,954 S * | 11/2019 | Yeh | D12/209 |
| D870,010 S * | 12/2019 | Hahn | D12/209 |
| D917,363 S * | 4/2021 | Aydin | D12/209 |
| D926,657 S * | 8/2021 | Kato | D12/211 |
| D928,063 S * | 8/2021 | Han | D12/211 |
| D928,064 S * | 8/2021 | Snyder | D12/209 |

* cited by examiner

Primary Examiner — Stacia A Cadmus

(57) **CLAIM**

I claim the ornamental design for an automotive wheel, as shown and described.

DESCRIPTION

FIG. 1 is a front perspective view of the automotive wheel of the claimed design;
FIG. 2 is a front view of the automotive wheel of FIG. 1;
FIG. 3 is a left side view of the automotive wheel of FIG. 1;
FIG. 4 is a right side view of the automotive wheel of FIG. 1;
FIG. 5 is a top view of the automotive wheel of FIG. 1; and,
FIG. 6 is a bottom view of the automotive wheel of FIG. 1.

1 Claim, 5 Drawing Sheets

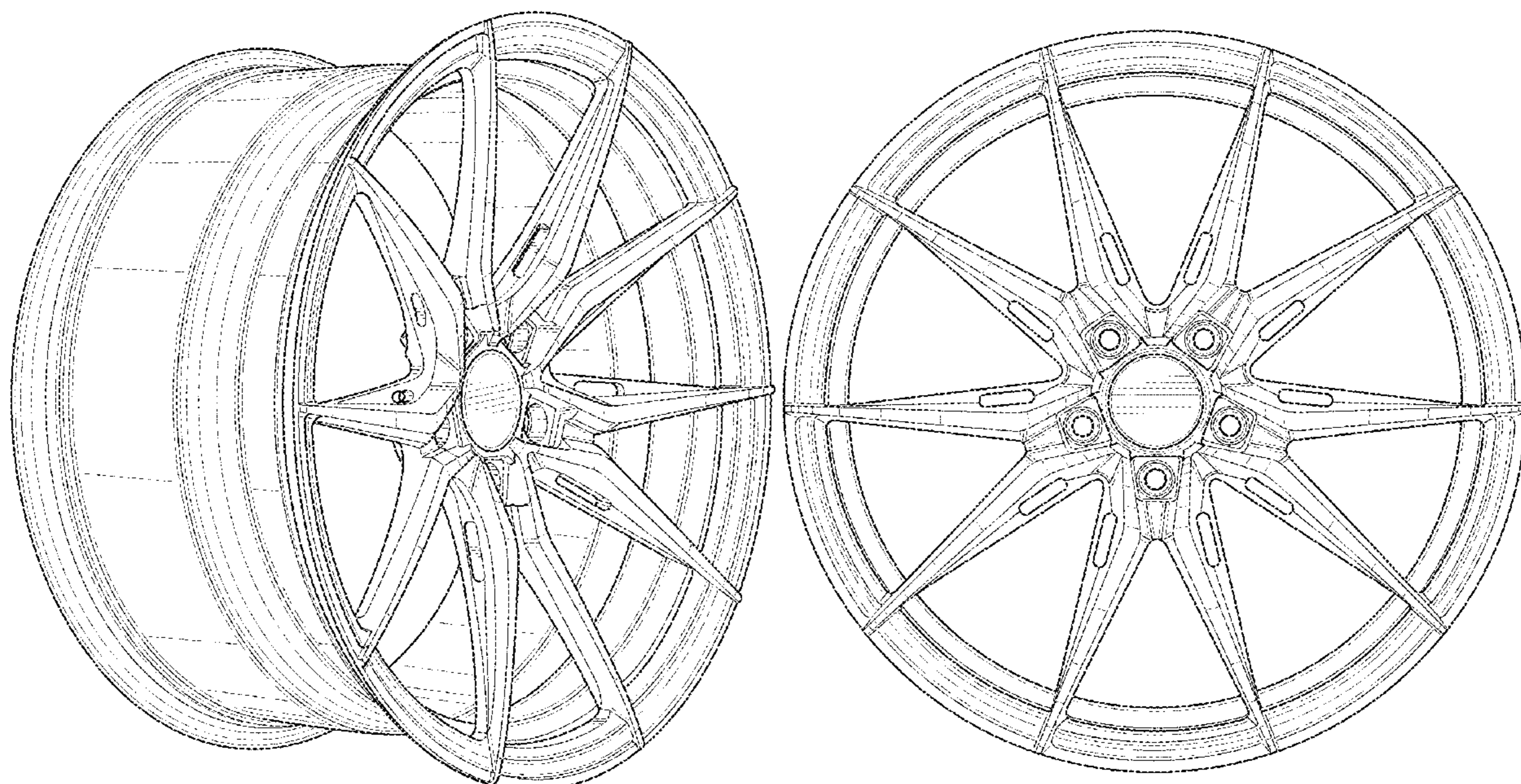

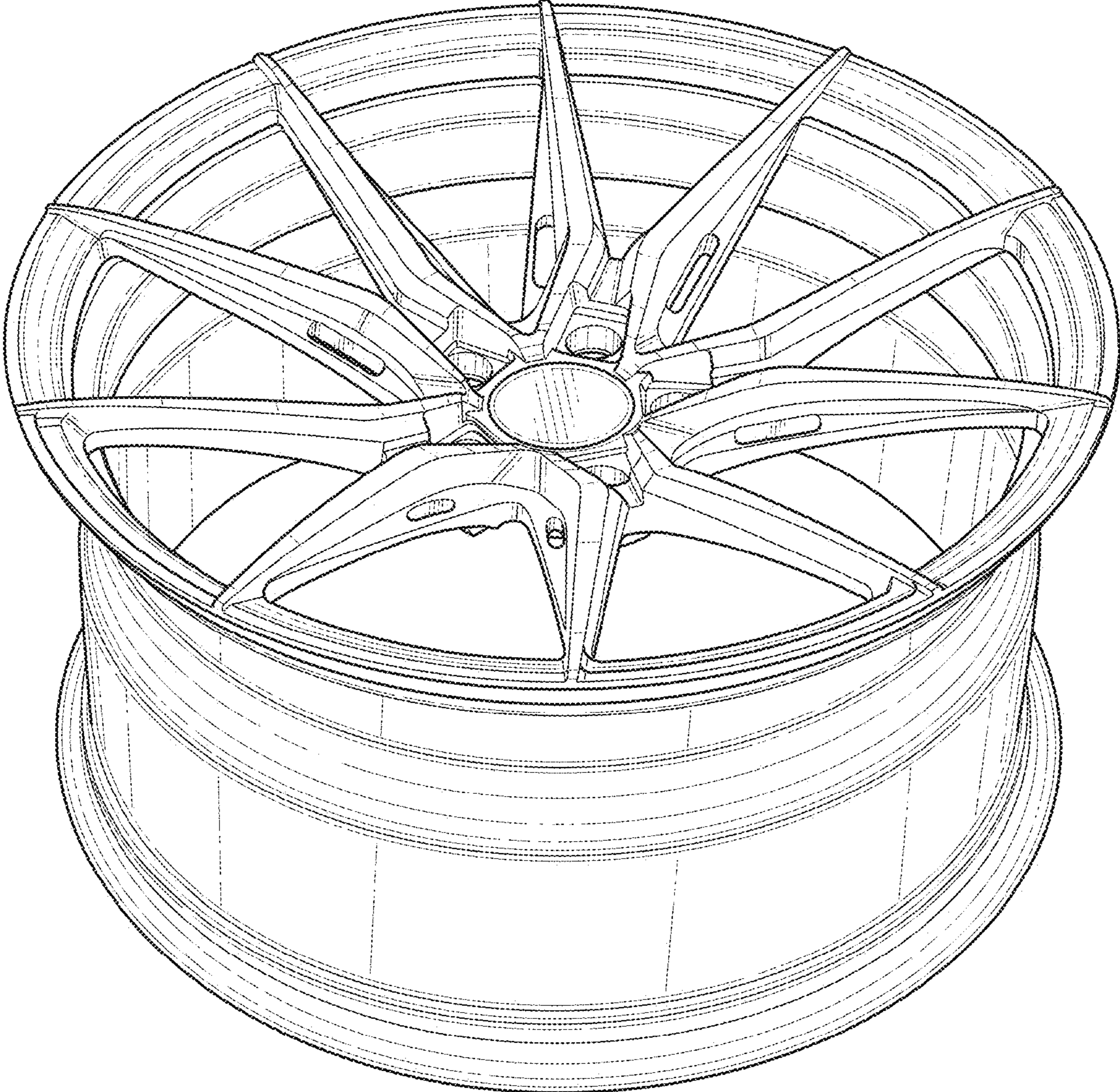

FIG. 1

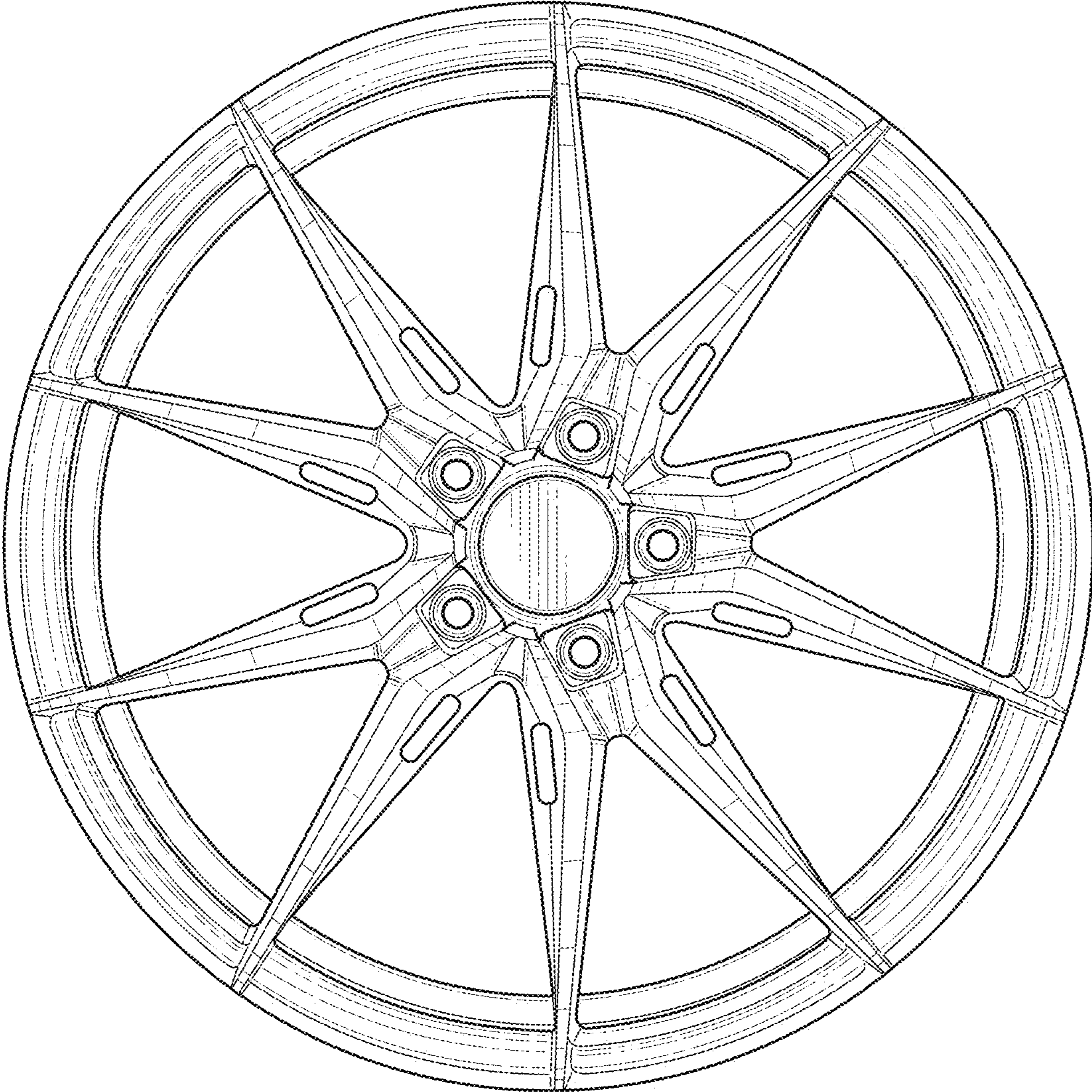

FIG. 2

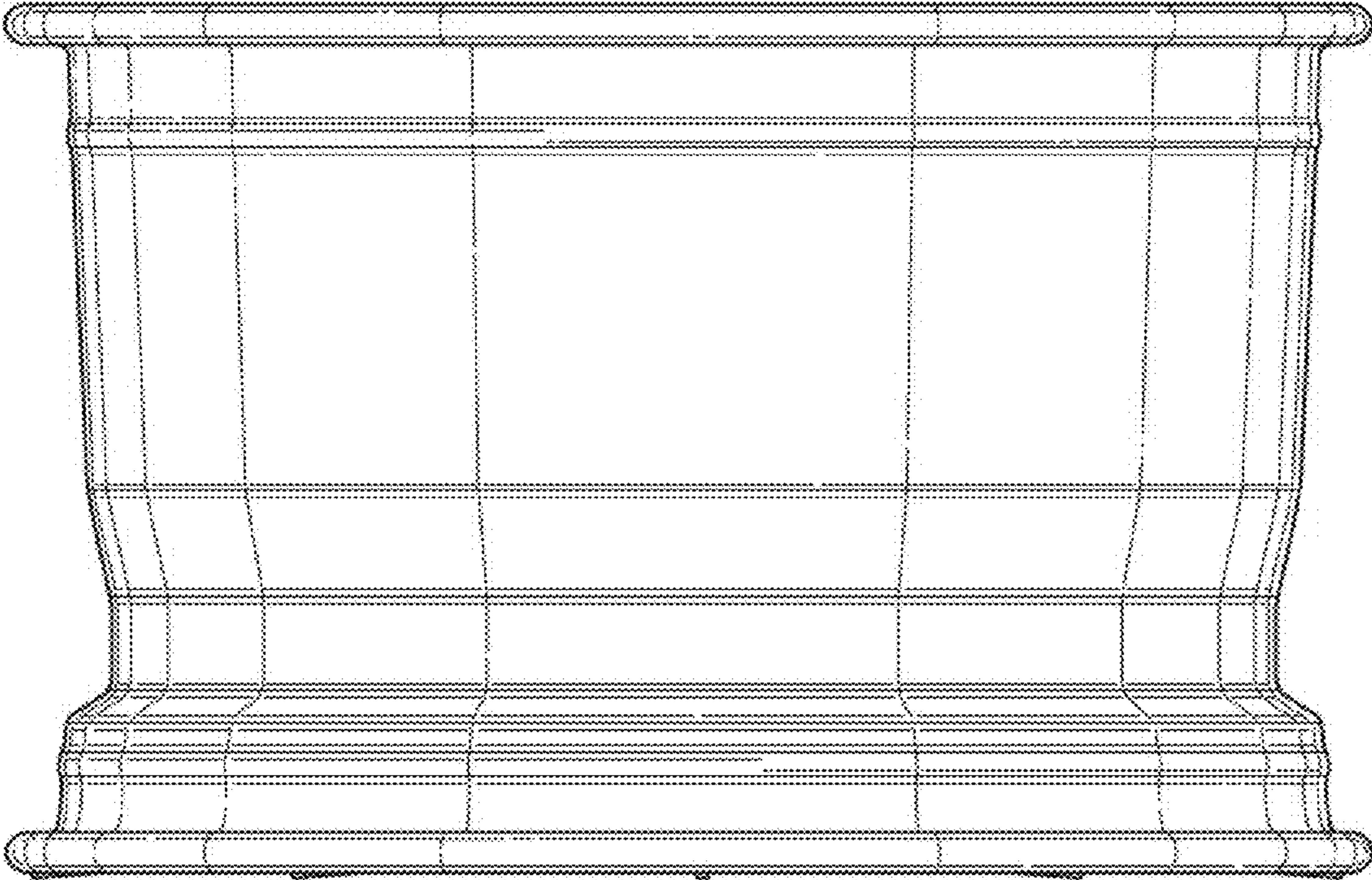

FIG. 4

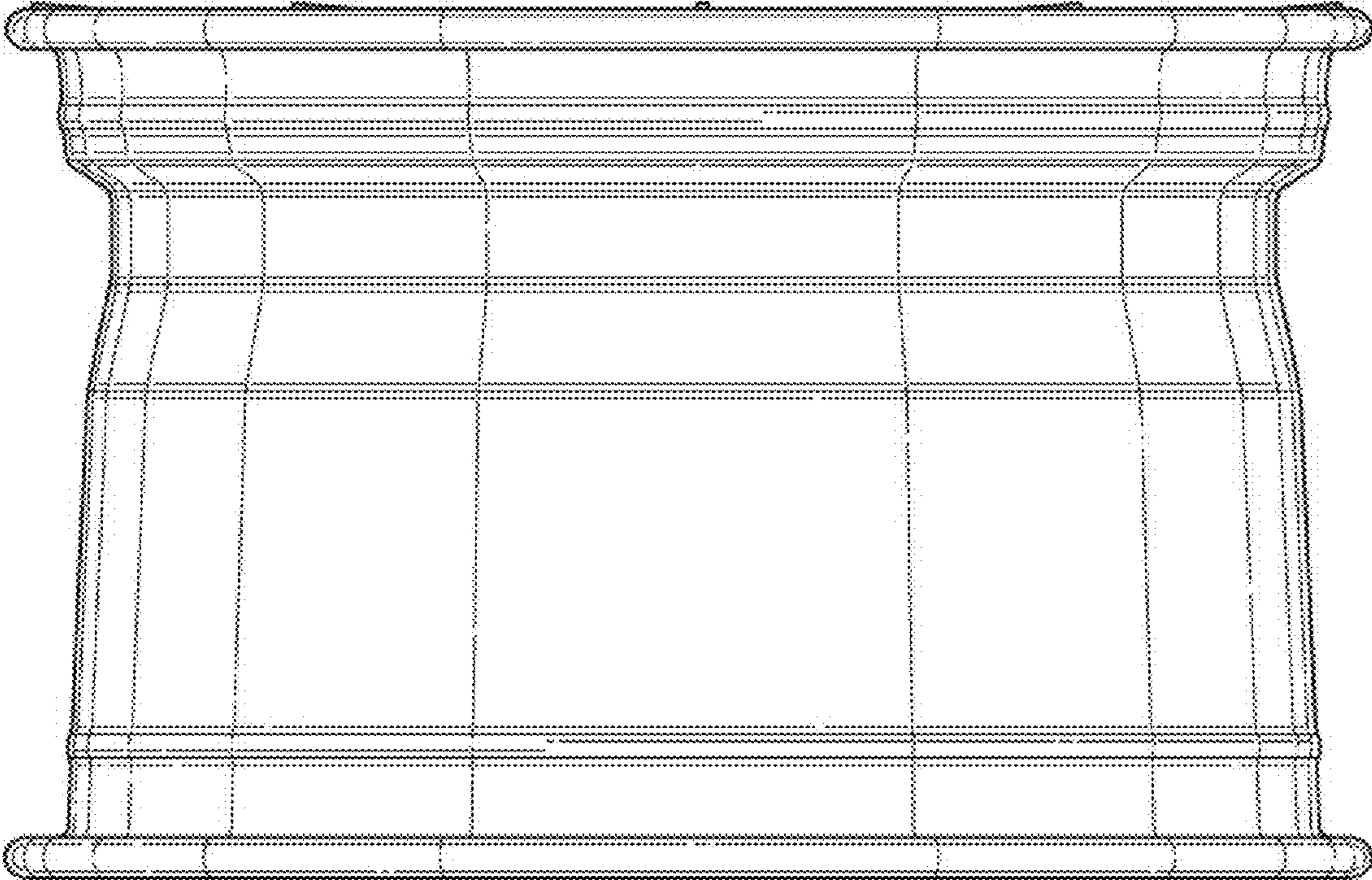

FIG. 3

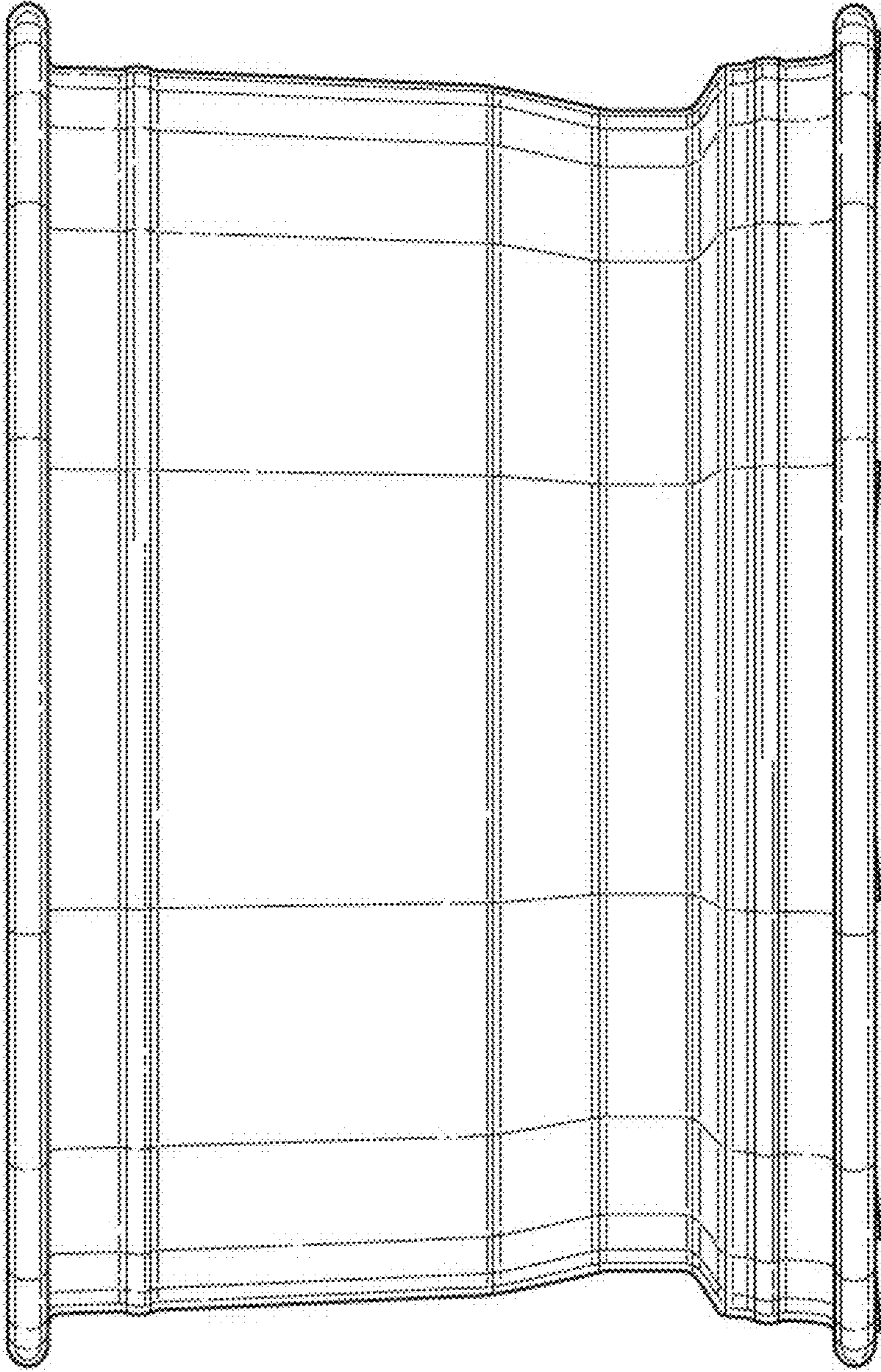

FIG. 5

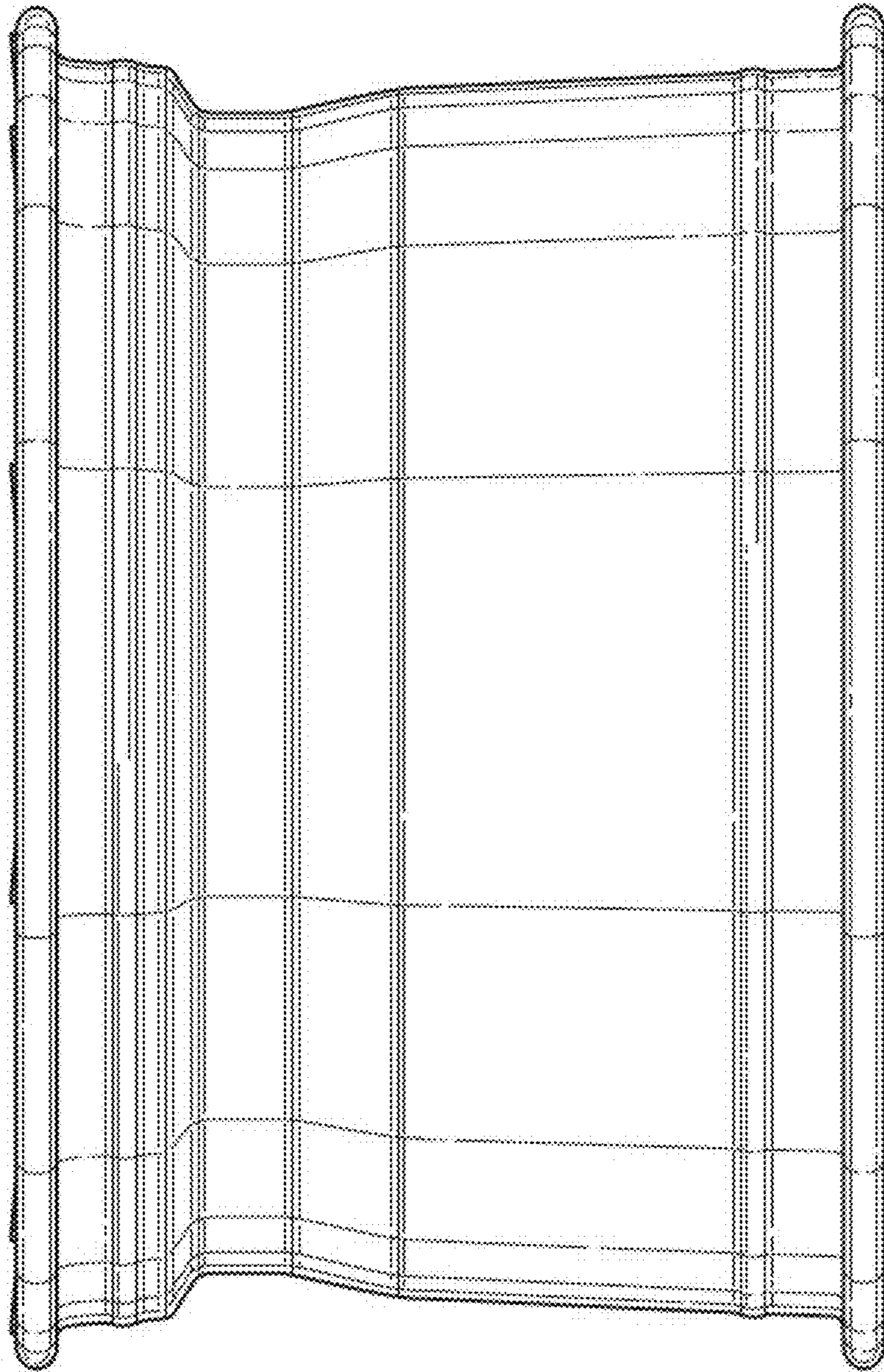

FIG. 6