



US00D946424S

(12) **United States Design Patent**
Sunada

(10) **Patent No.:** **US D946,424 S**

(45) **Date of Patent:** **** Mar. 22, 2022**

(54) **MOISTURE METER**

(71) Applicant: **Shizuoka Seiki Co., Ltd.**, Shizuoka (JP)

(72) Inventor: **Masashi Sunada**, Fukuroi (JP)

(73) Assignee: **Shizuoka Seiki Co., Ltd.**, Shizuoka (JP)

(**) Term: **15 Years**

(21) Appl. No.: **35/510,773**

(22) Filed: **May 19, 2020**

(80) **Hague Agreement Data**

Int. Filing Date: **May 19, 2020**

Int. Reg. No.: **DM/209918**

Int. Reg. Date: **May 19, 2020**

Int. Reg. Pub. Date: **Nov. 20, 2020**

(30) **Foreign Application Priority Data**

Nov. 25, 2019 (JP) 2019-026065

(51) **LOC (13) Cl.** **10-04**

(52) **U.S. Cl.**
USPC **D10/56**

(58) **Field of Classification Search**
USPC D10/52, 53, 56
CPC A01G 25/167; G01N 5/045; G01N 22/04
See application file for complete search history.

(56) **References Cited**

U.S. PATENT DOCUMENTS

D256,783 S * 9/1980 Moon D10/56
6,092,924 A * 7/2000 Scalese G01N 22/04
333/208

D438,808 S * 3/2001 Dwertmann D10/81
6,247,246 B1 * 6/2001 Scalese G01N 5/045
219/678
6,320,170 B1 * 11/2001 Jennings G01N 5/045
219/679
D781,162 S * 3/2017 Wang D10/56
D813,693 S * 3/2018 Walker D10/53
D832,119 S * 10/2018 Choi D10/52
D838,189 S * 1/2019 Choi D10/52
D840,251 S * 2/2019 Choi D10/52
D841,490 S * 2/2019 Boedhoe D10/56
D854,950 S * 7/2019 Seum D10/53
D863,990 S * 10/2019 Hu D10/52
11,006,590 B2 * 5/2021 Kumar A01G 25/167

* cited by examiner

Primary Examiner — George D. Kirschbaum

(74) *Attorney, Agent, or Firm* — Schiff Hardin LLP

(57) **CLAIM**

The ornamental design for a moisture meter, as shown and described.

DESCRIPTION

- 1. Moisture meter
- 1.1 : Perspective
- 1.2 : Front
- 1.3 : Back
- 1.4 : Top
- 1.5 : Bottom
- 1.6 : Left
- 1.7 : Right

1 Claim, 7 Drawing Sheets

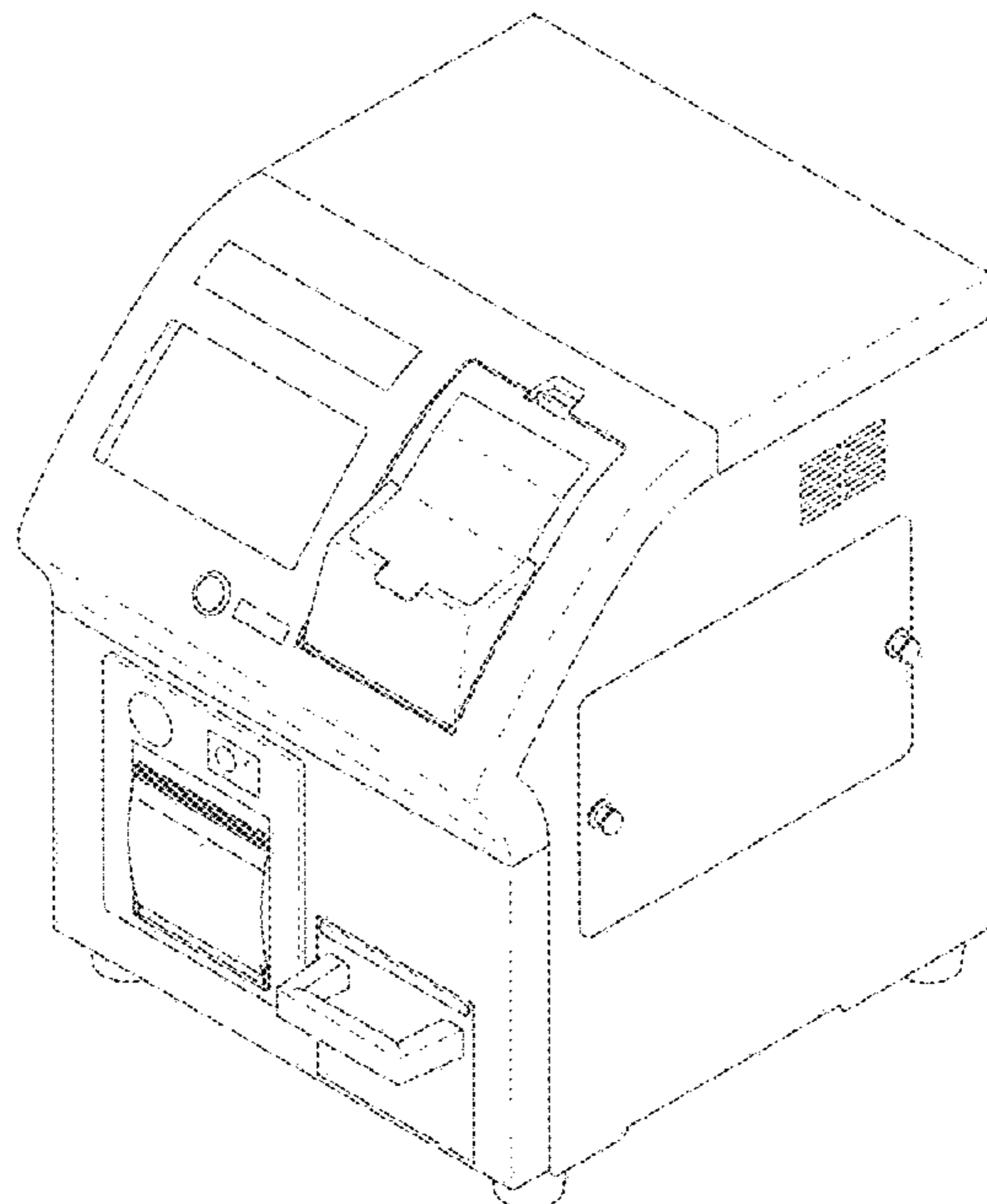

1.1

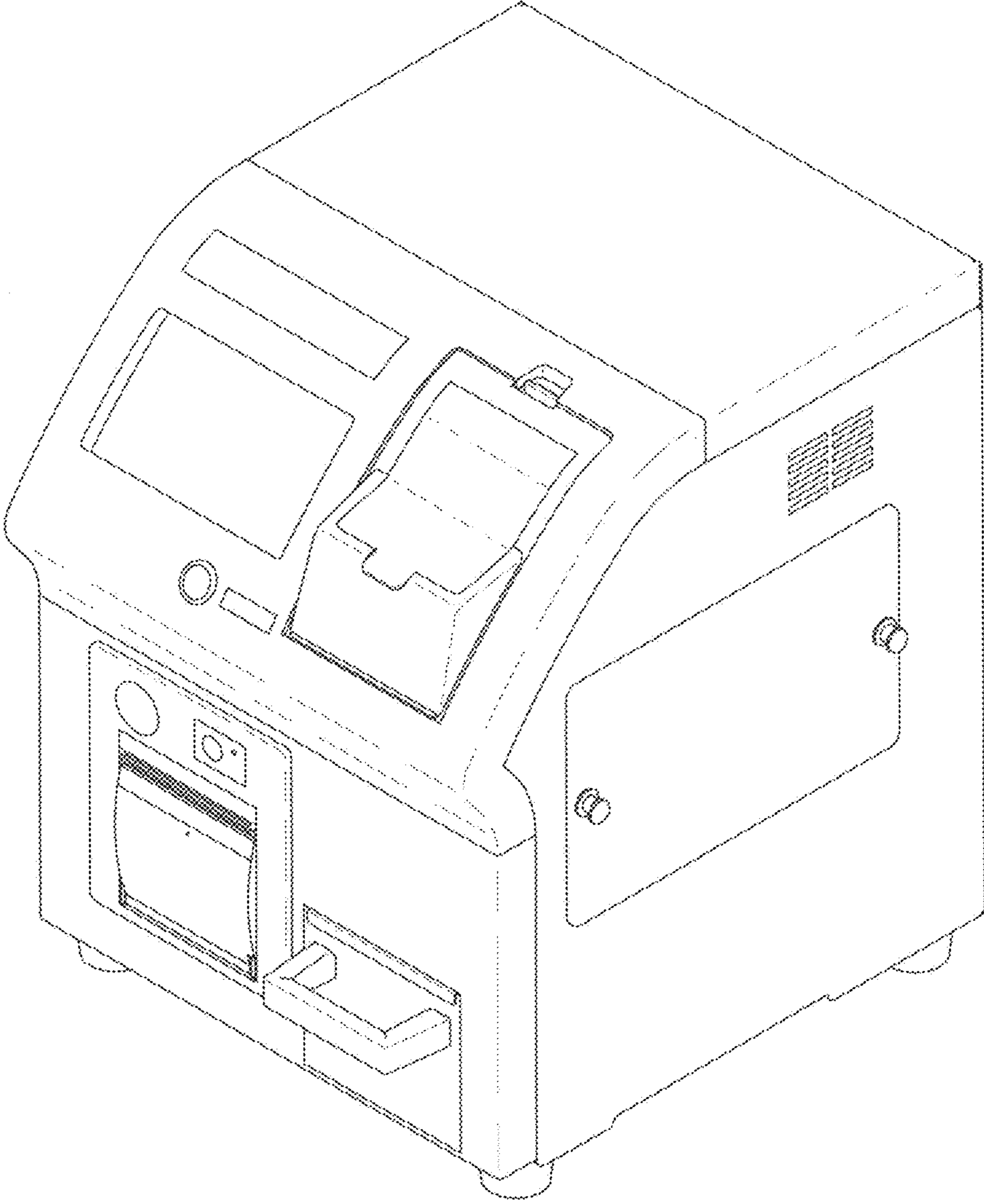

1.2

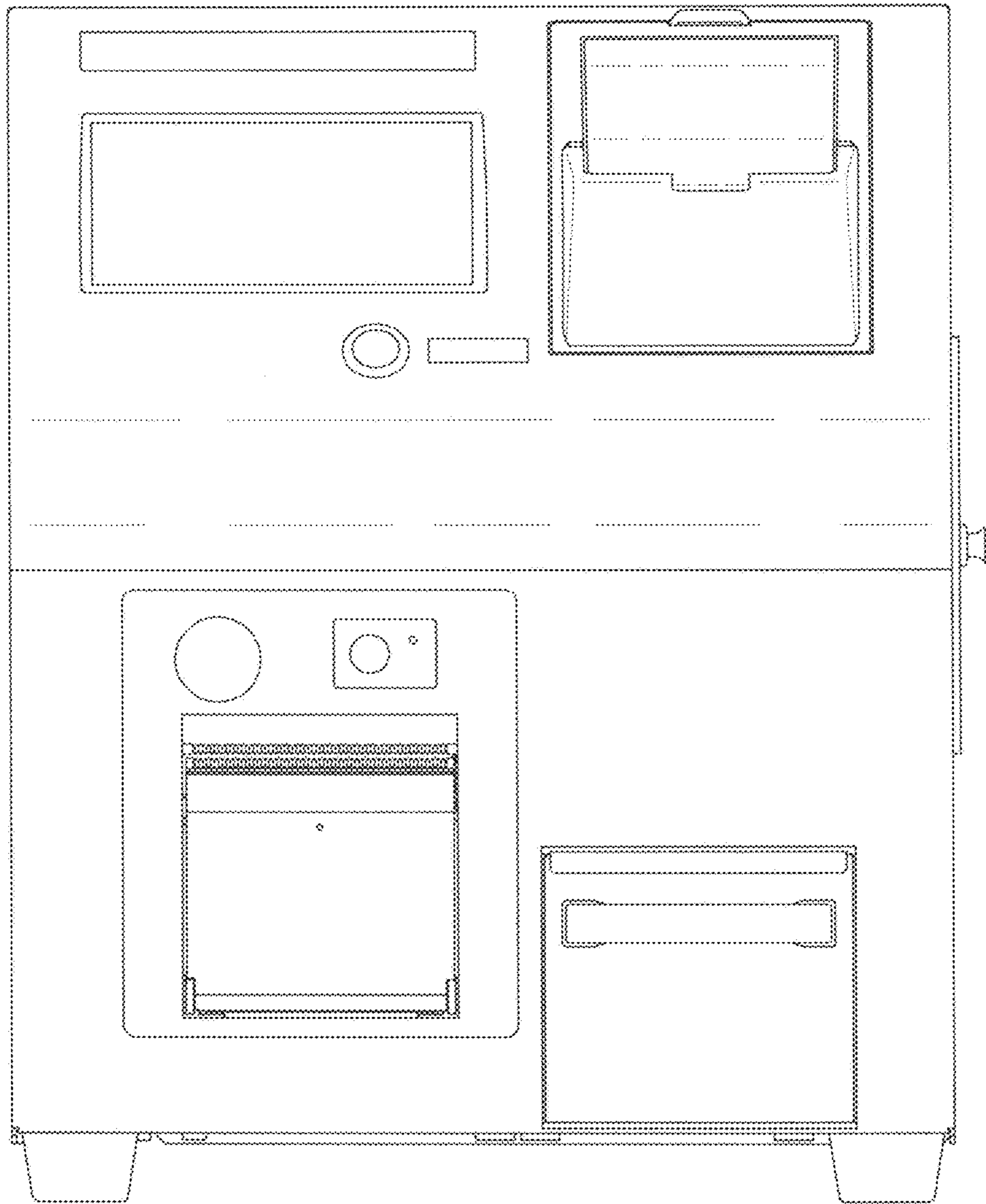

1.3

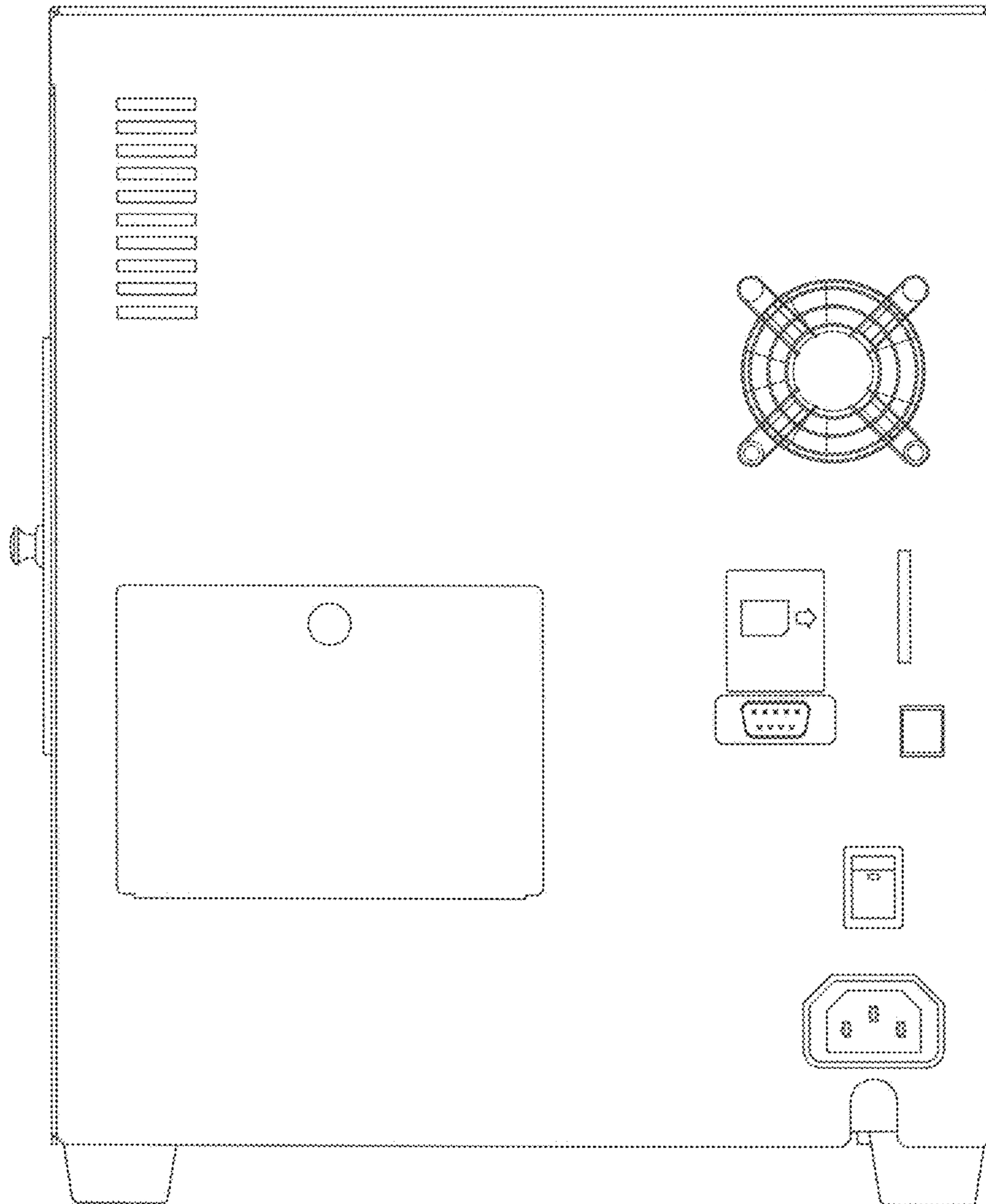

1.4

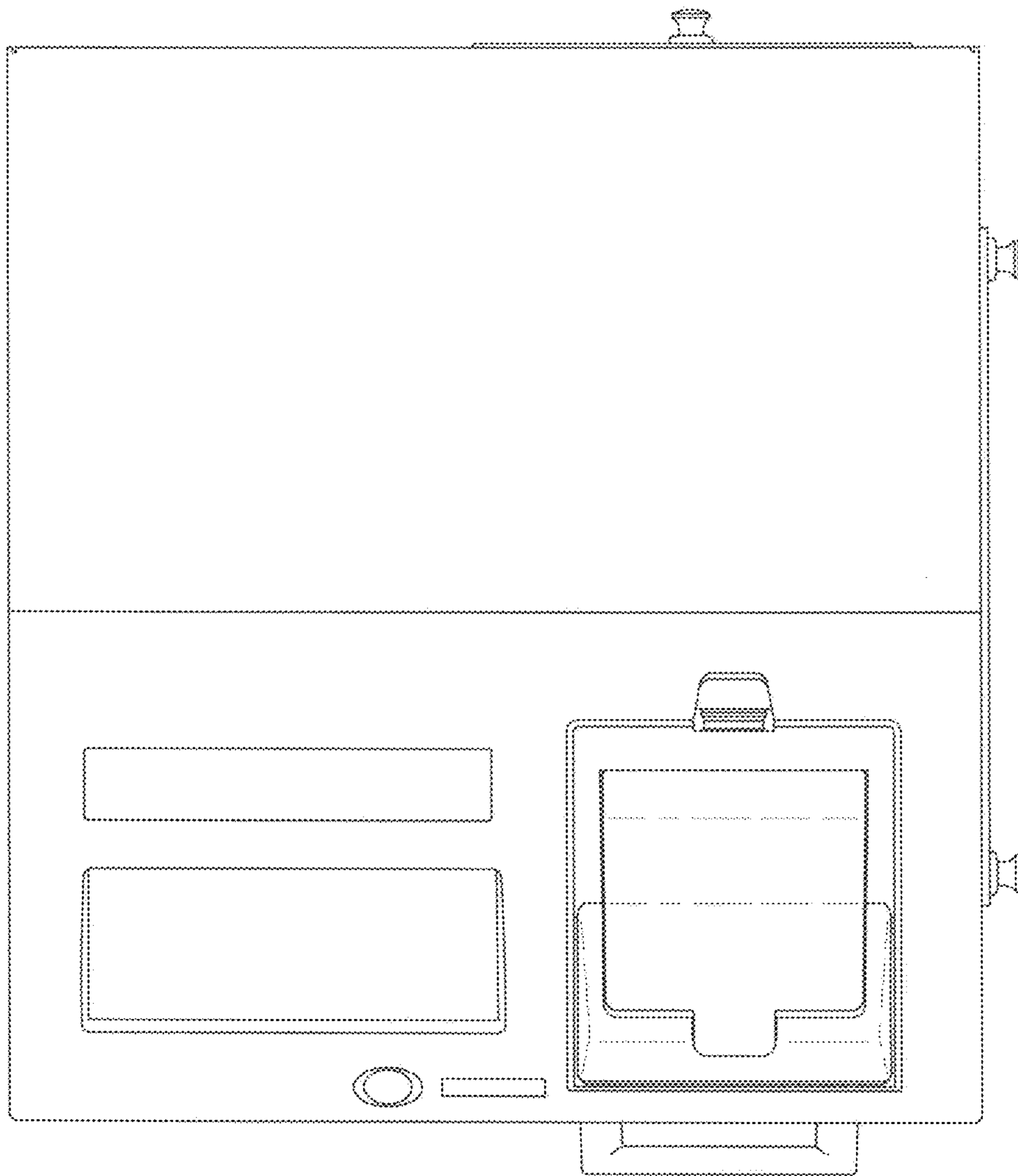

1.5

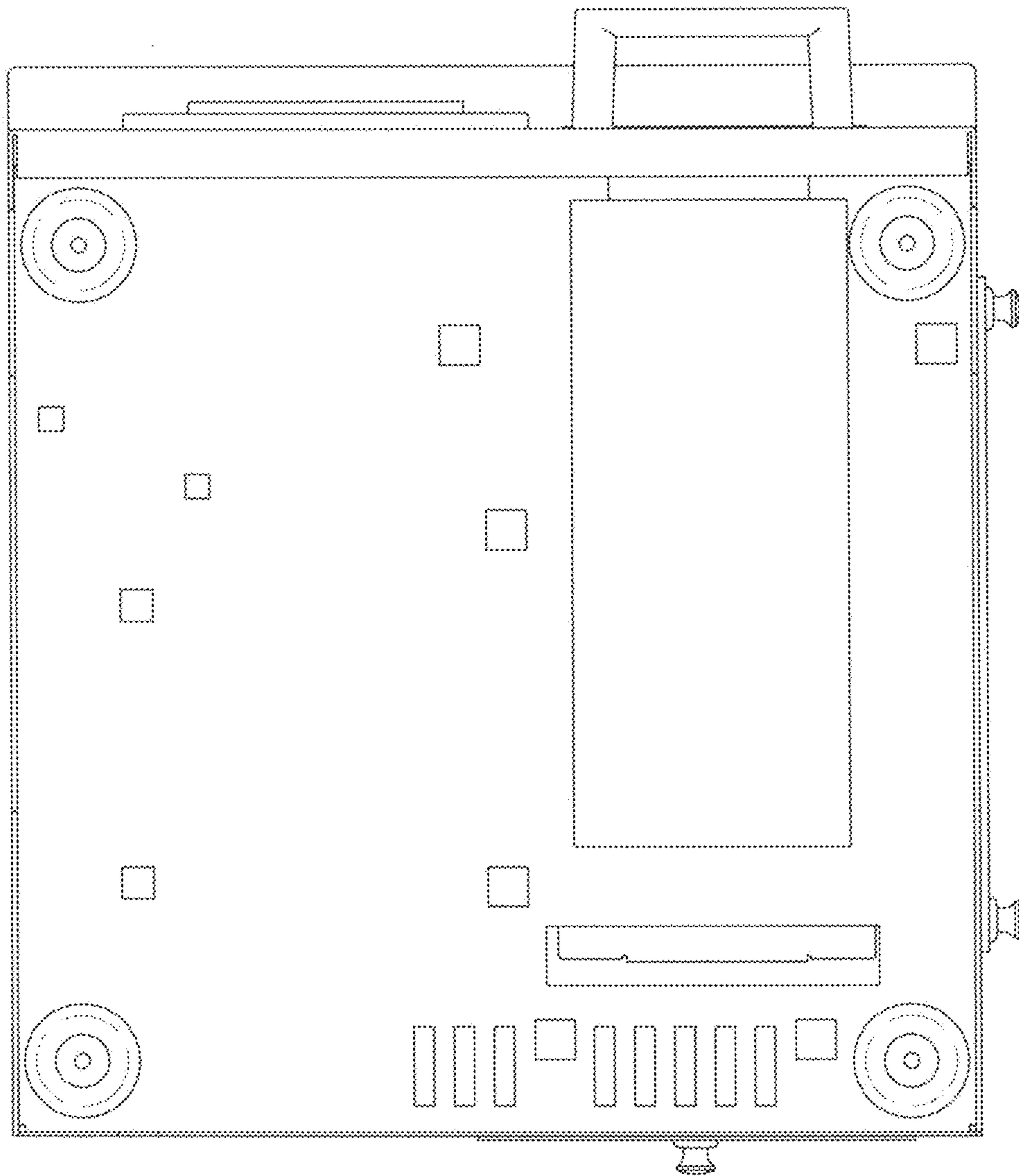

1.6

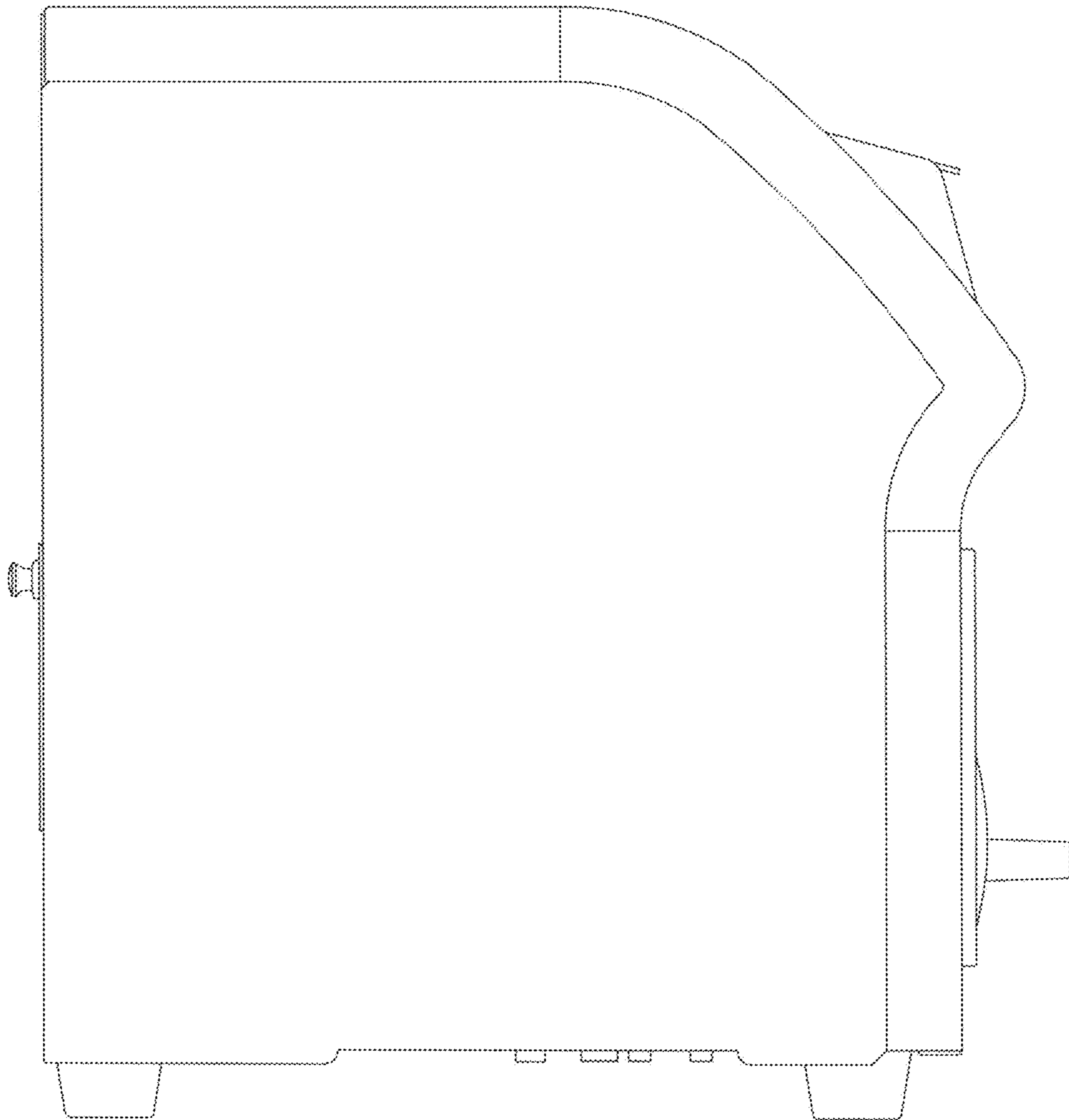

1.7

