



US00D946411S

(12) **United States Design Patent**
Miller et al.

(10) **Patent No.:** **US D946,411 S**

(45) **Date of Patent:** **** Mar. 22, 2022**

(54) **BOTTLE**

(71) Applicant: **The Absolut Company Aktiebolag**,
Stockholm (SE)

(72) Inventors: **Rowan Miller**, Stockholm (SE); **Clare Vickers**, Stockholm (SE); **Ivan Bell**, Stockholm (SE); **Nick Baker**, Stockholm (SE)

(73) Assignee: **The Absolut Company Aktiebolag**,
Stockholm (SE)

(**) Term: **15 Years**

(21) Appl. No.: **29/664,586**

(22) Filed: **Sep. 26, 2018**

(30) **Foreign Application Priority Data**

Mar. 29, 2018 (SE) 2018/0095

(51) **LOC (13) Cl.** **09-01**

(52) **U.S. Cl.**
USPC **D9/560**

(58) **Field of Classification Search**
USPC D9/522, 523, 524, 526, 537, 542, 549,
D9/553, 550, 551, 690

CPC B65D 1/02; B65D 1/0223; B65D 1/023;
B65D 1/0261; B65D 2501/0009; B65D
2501/0081; B65D 2501/009

See application file for complete search history.

(56) **References Cited**

U.S. PATENT DOCUMENTS

D332,051 S * 12/1992 Kinslow, Jr. D9/520
D369,555 S * 5/1996 Heinz D9/545
D411,740 S * 6/1999 Kim D9/658

D447,062 S * 8/2001 Cheng D9/553
D509,145 S * 9/2005 Dorn D9/550
D527,648 S * 9/2006 Darr D9/566
D530,212 S * 10/2006 Darr D9/543
D603,712 S * 11/2009 James D9/538
D644,111 S * 8/2011 Williams D9/550
D727,161 S * 4/2015 Fort D9/550
D830,841 S * 10/2018 Toothman D9/553

* cited by examiner

Primary Examiner — Janice Patyk

(74) *Attorney, Agent, or Firm* — Arnold & Porter Kaye
Scholer LLP

(57) **CLAIM**

The ornamental design for a bottle, as shown and described.

DESCRIPTION

FIG. 1 is a front perspective view of embodiment one of a bottle, showing the present design;
FIG. 2 is a front view thereof;
FIG. 3 is a rear view thereof;
FIG. 4 is a left side view thereof;
FIG. 5 is a right side view thereof;
FIG. 6 is a top view thereof;
FIG. 7 is a bottom view thereof;
FIG. 8 is a bottom perspective view thereof.
FIG. 9 is a front perspective view of embodiment two of a bottle, showing the present design;
FIG. 10 is a front view thereof;
FIG. 11 is a rear view thereof;
FIG. 12 is a left side view thereof;
FIG. 13 is a right side view thereof;
FIG. 14 is a top view thereof;
FIG. 15 is a bottom view thereof; and,
FIG. 16 is a bottom perspective view thereof.

1 Claim, 14 Drawing Sheets

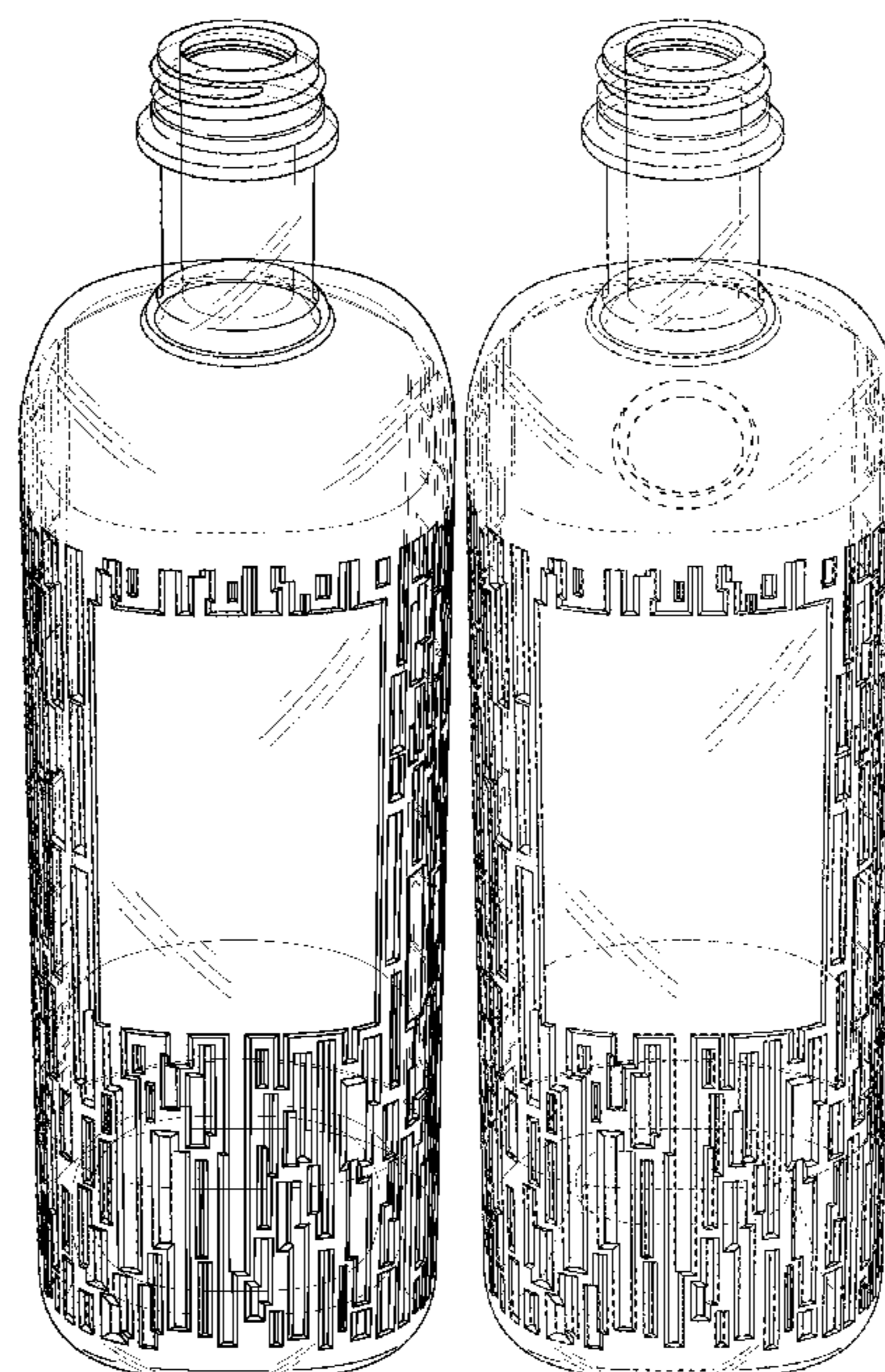

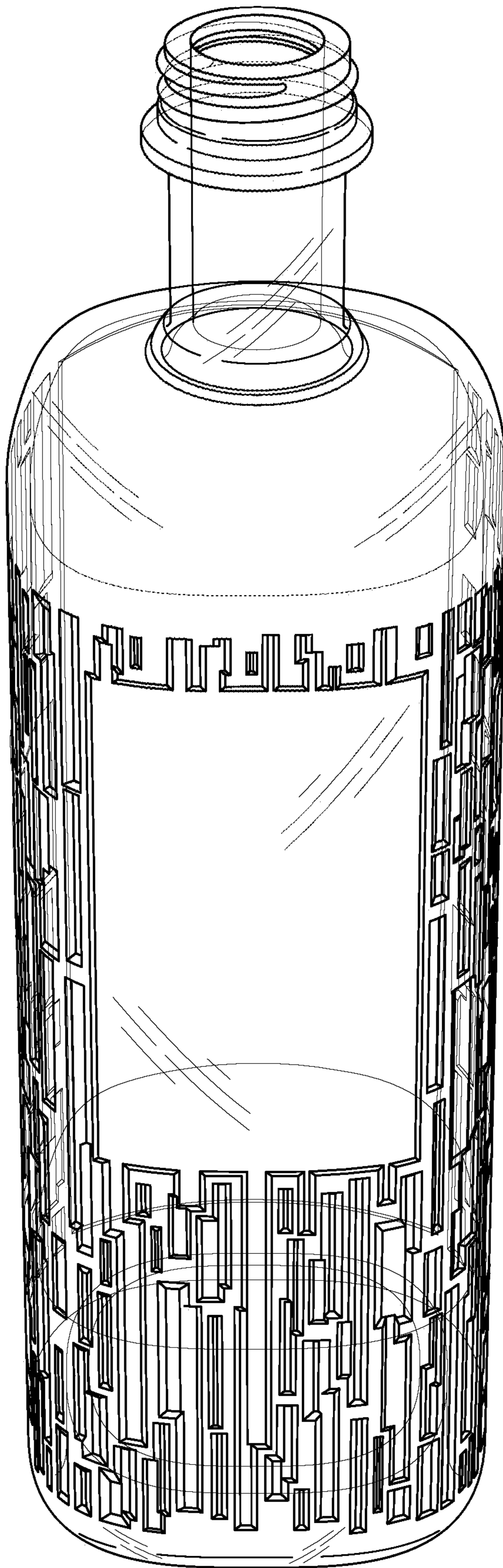

FIG. 1

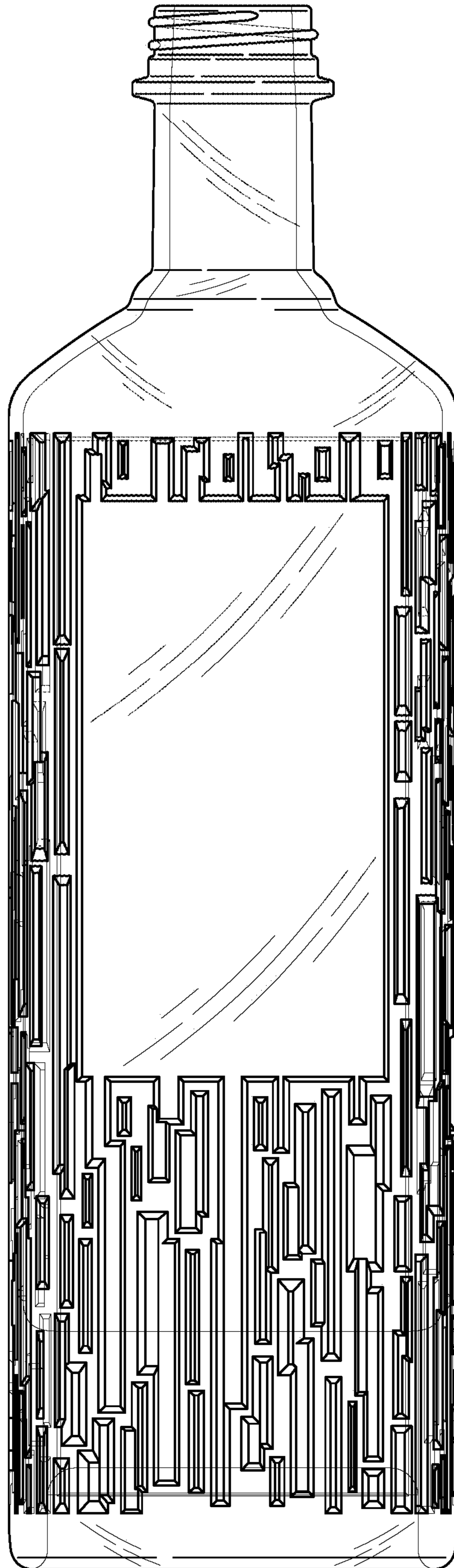

FIG. 2

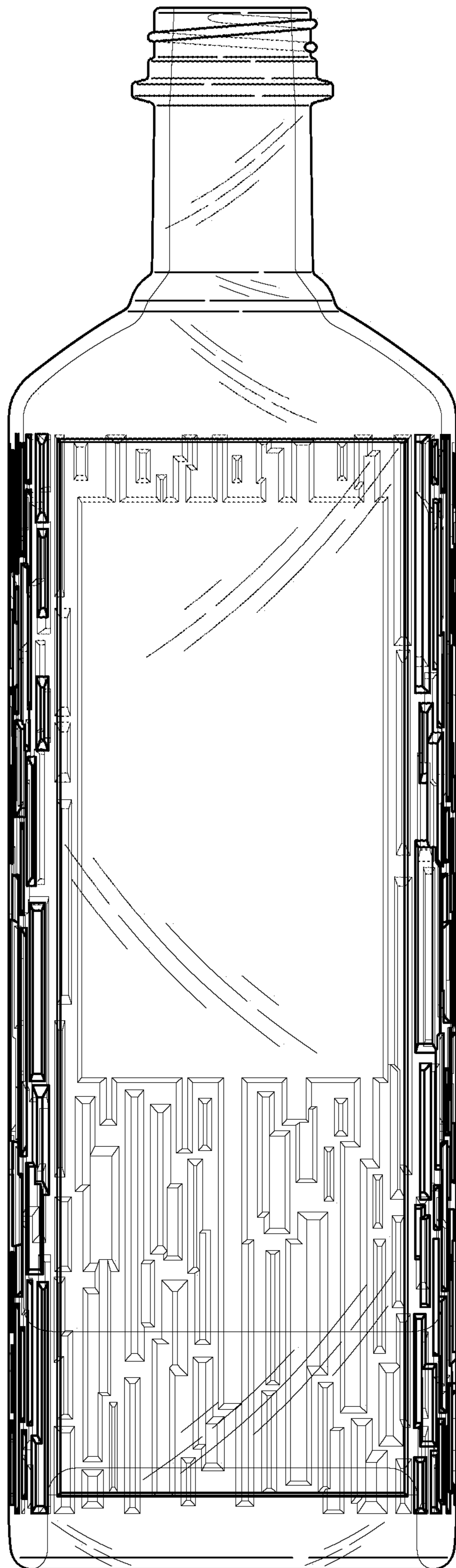

FIG. 3

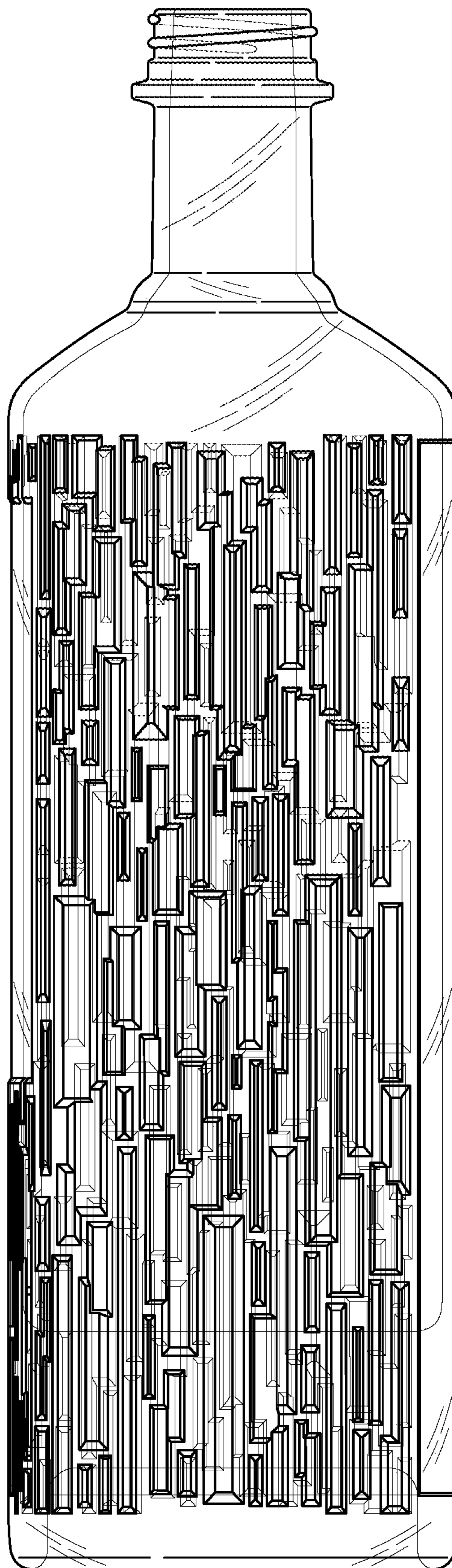

FIG. 4

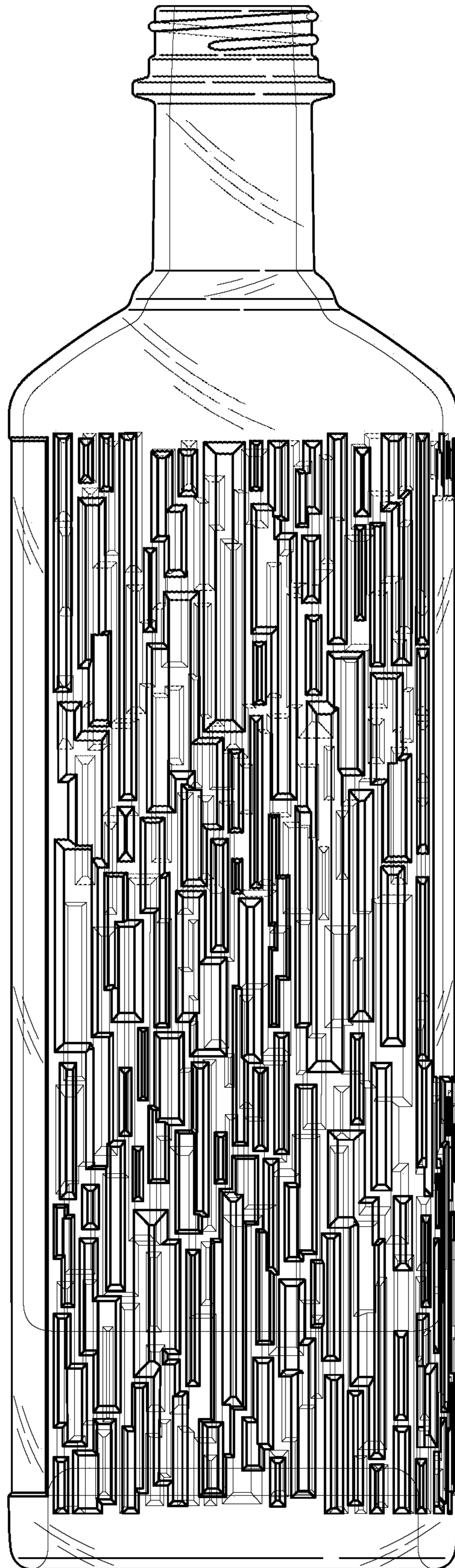

FIG. 5

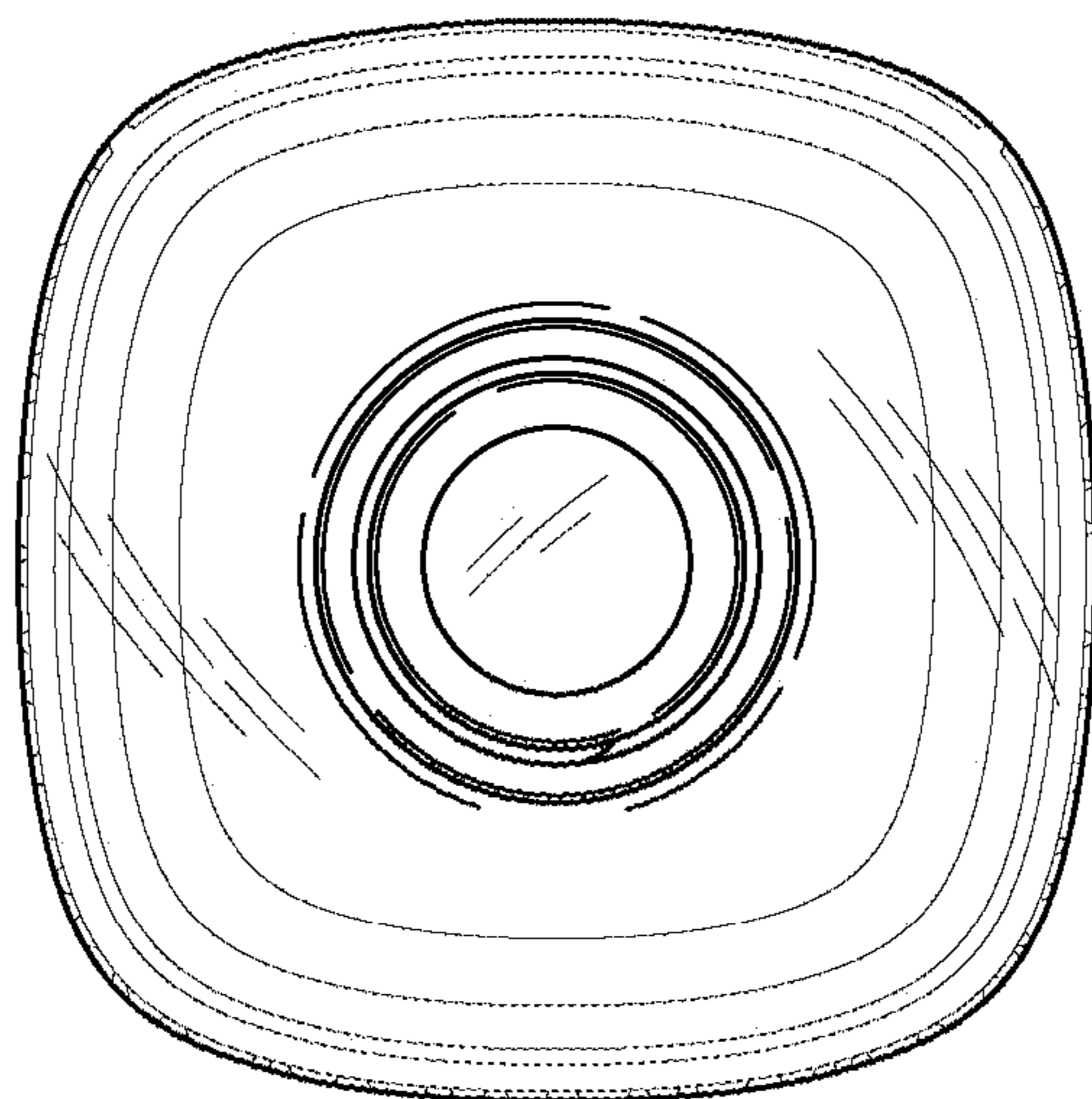

FIG. 6

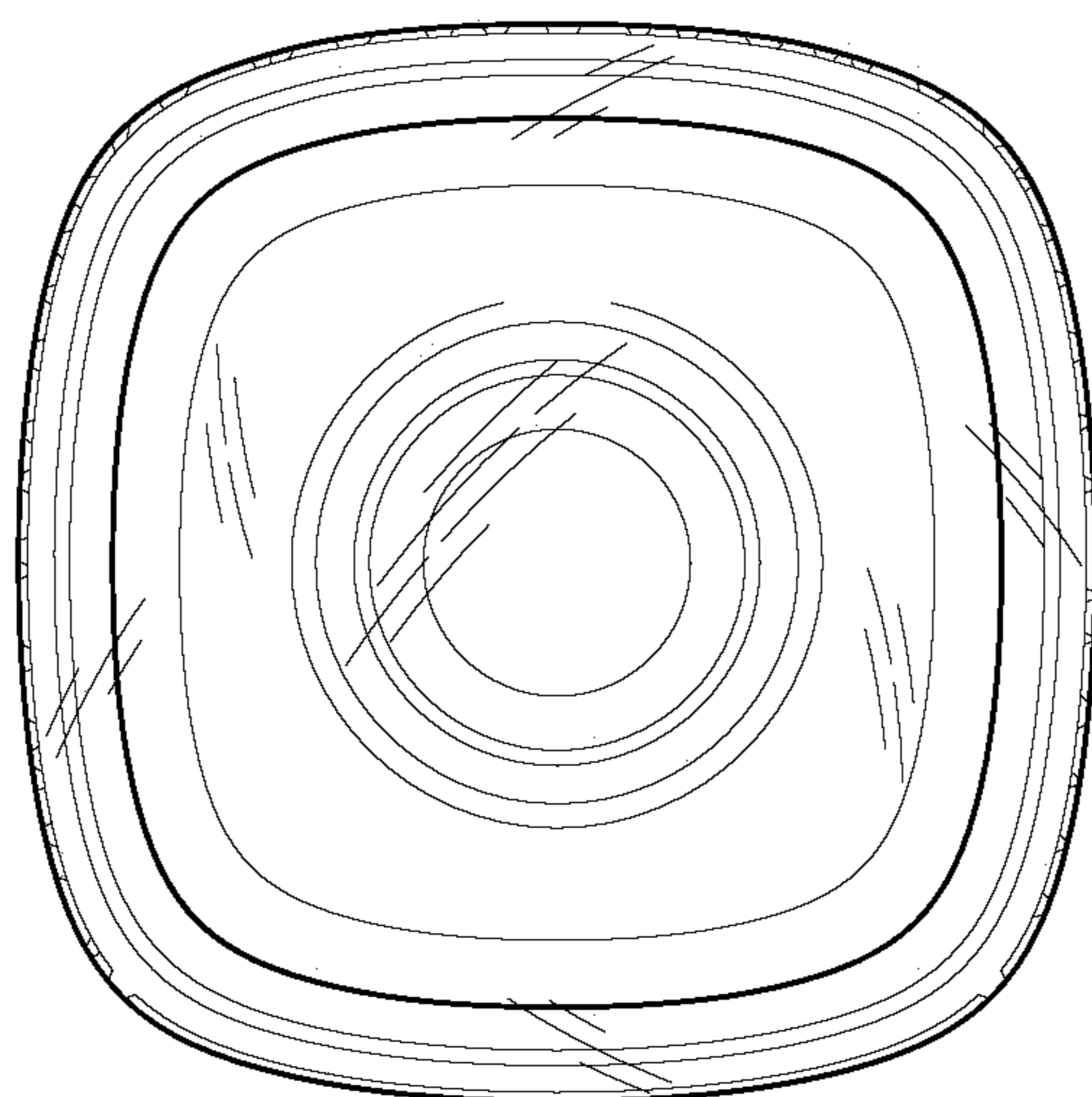

FIG. 7

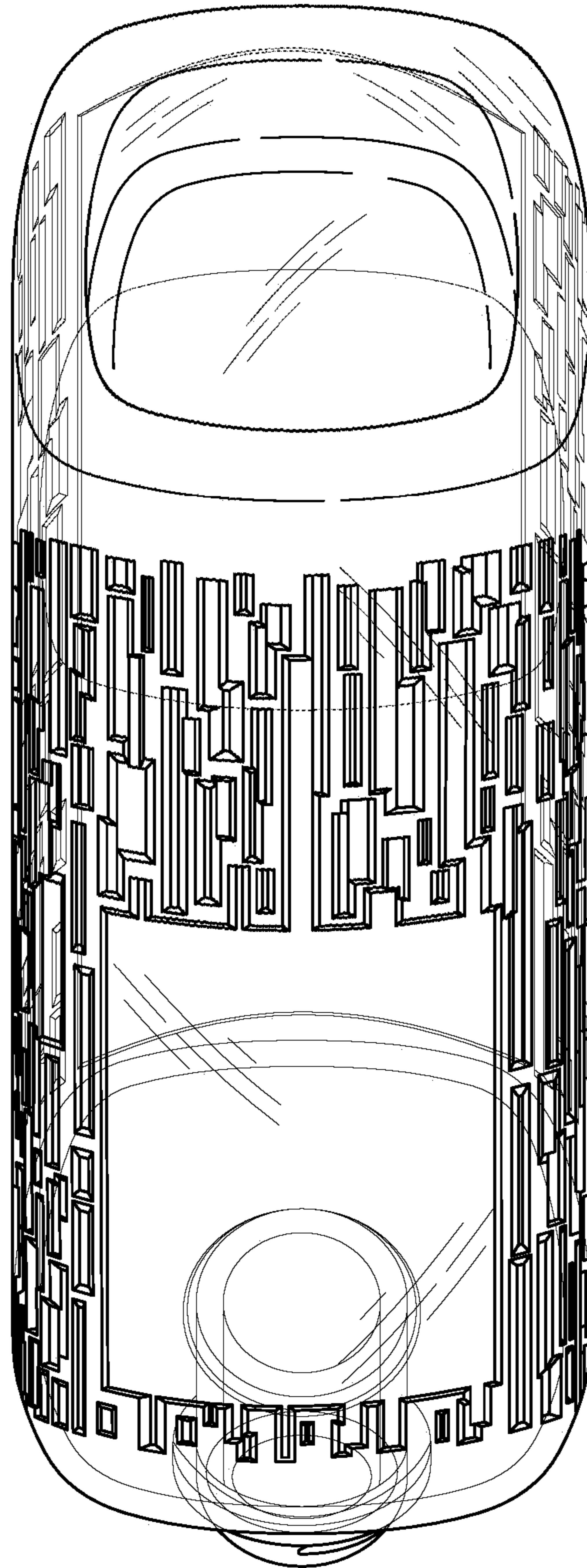

FIG. 8

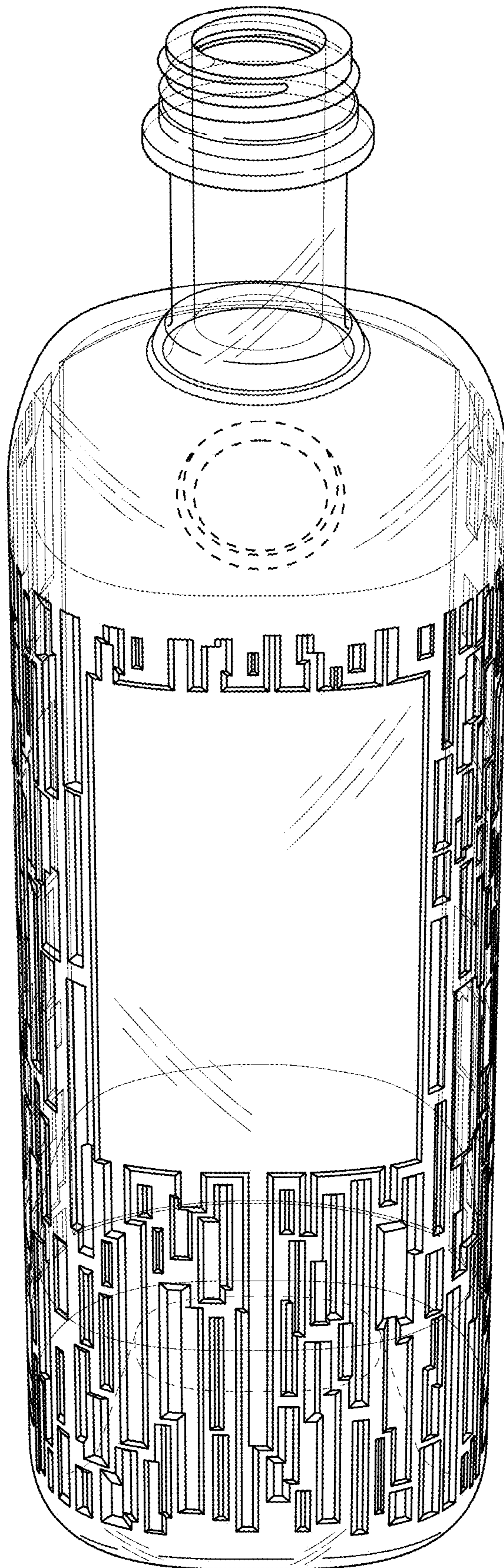

FIG. 9

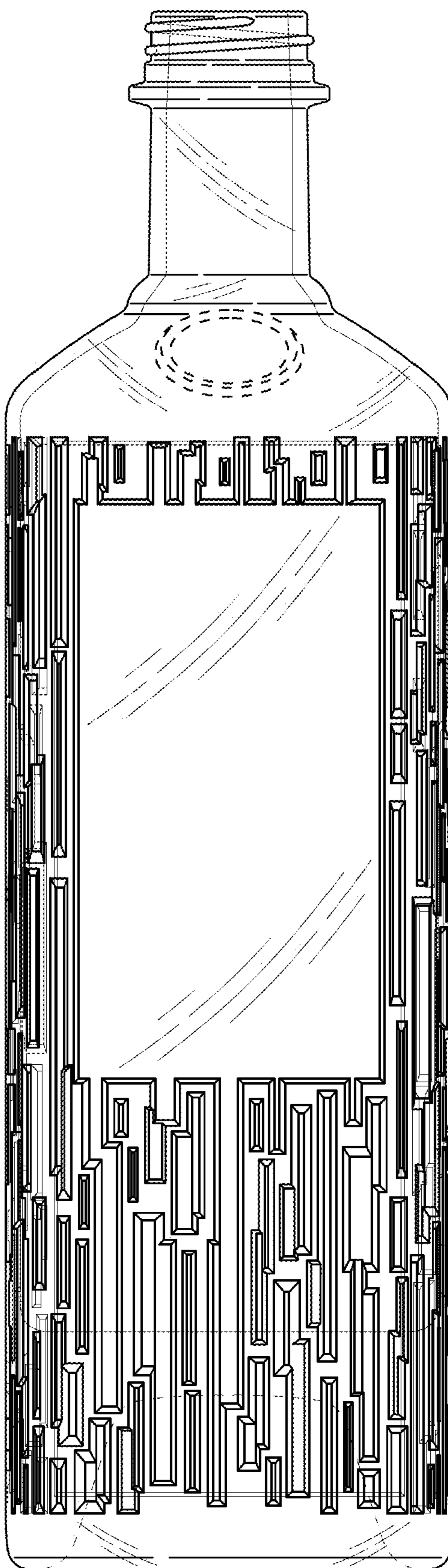

FIG. 10

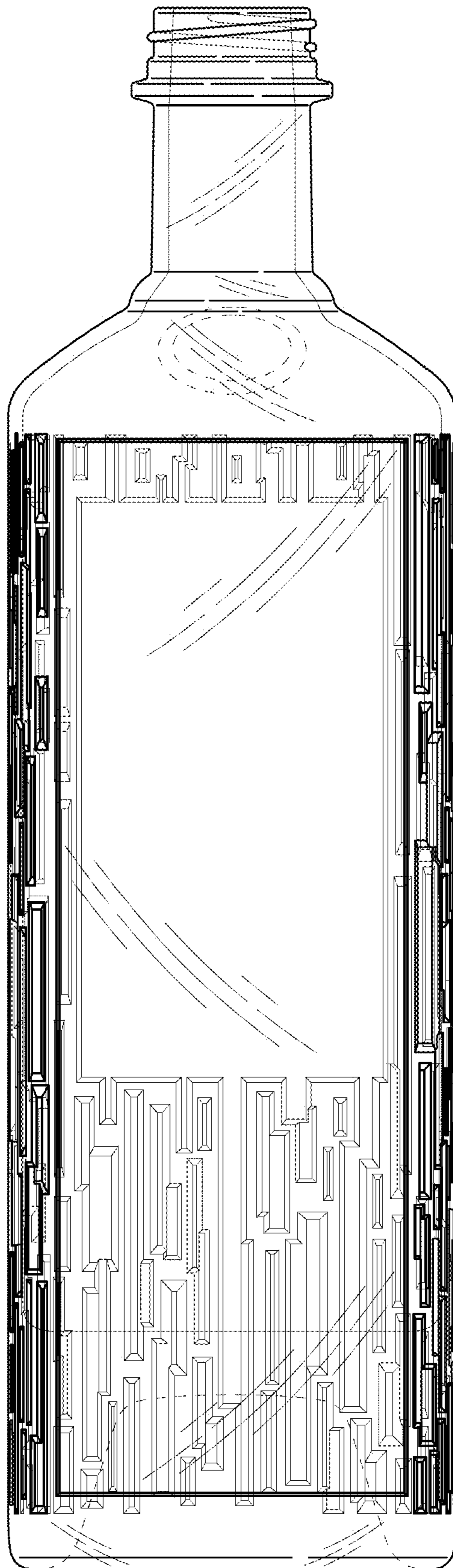

FIG. 11

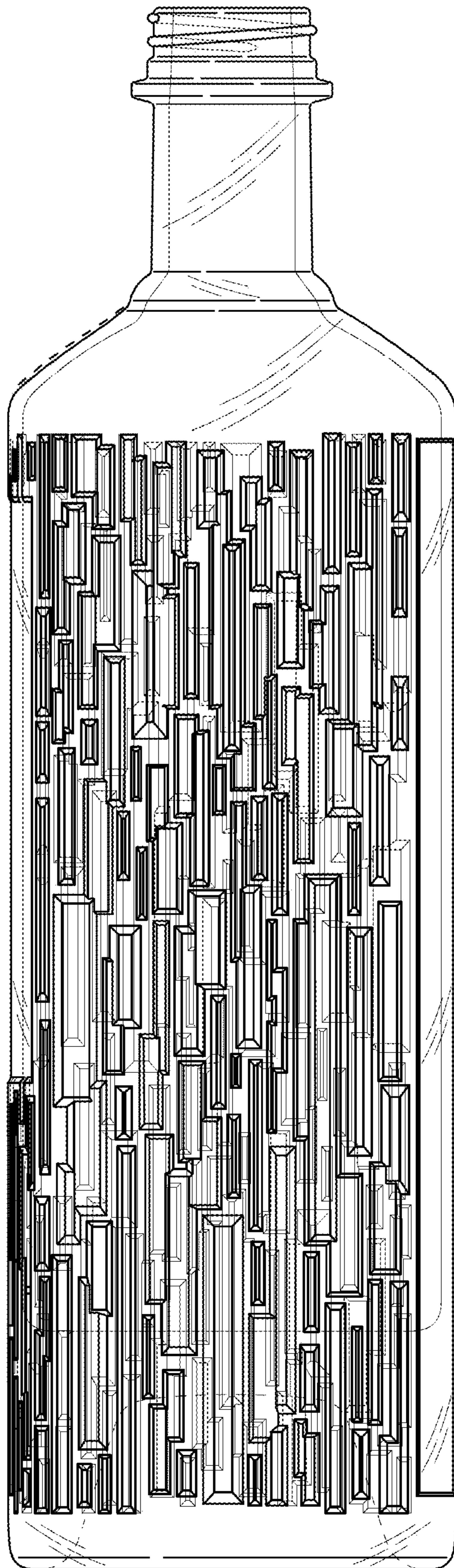

FIG. 12

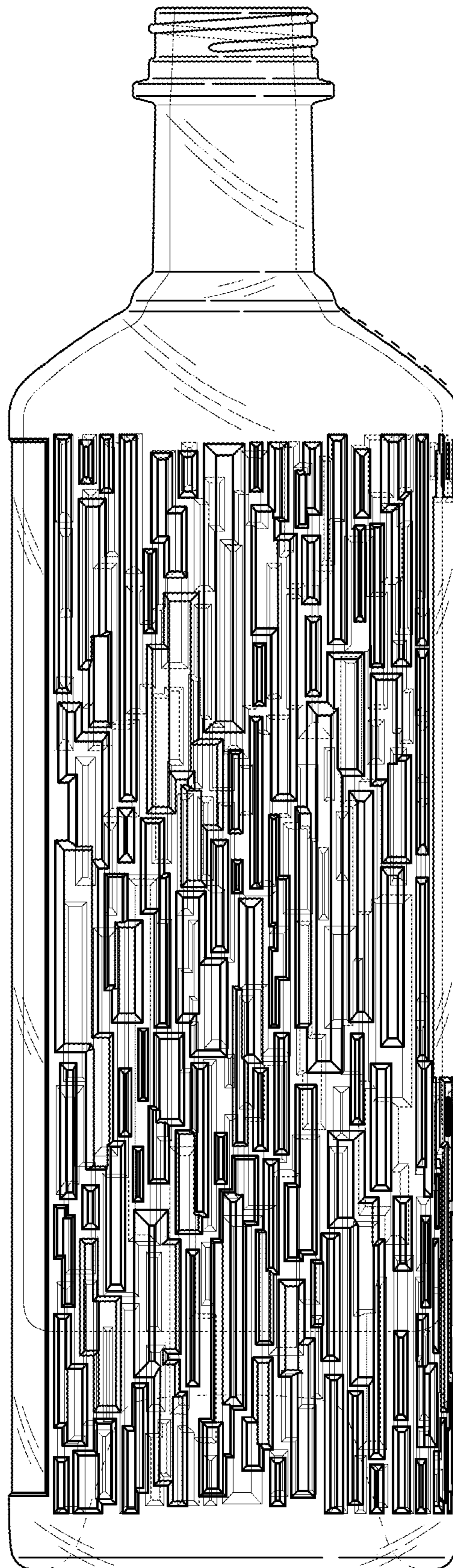

FIG. 13

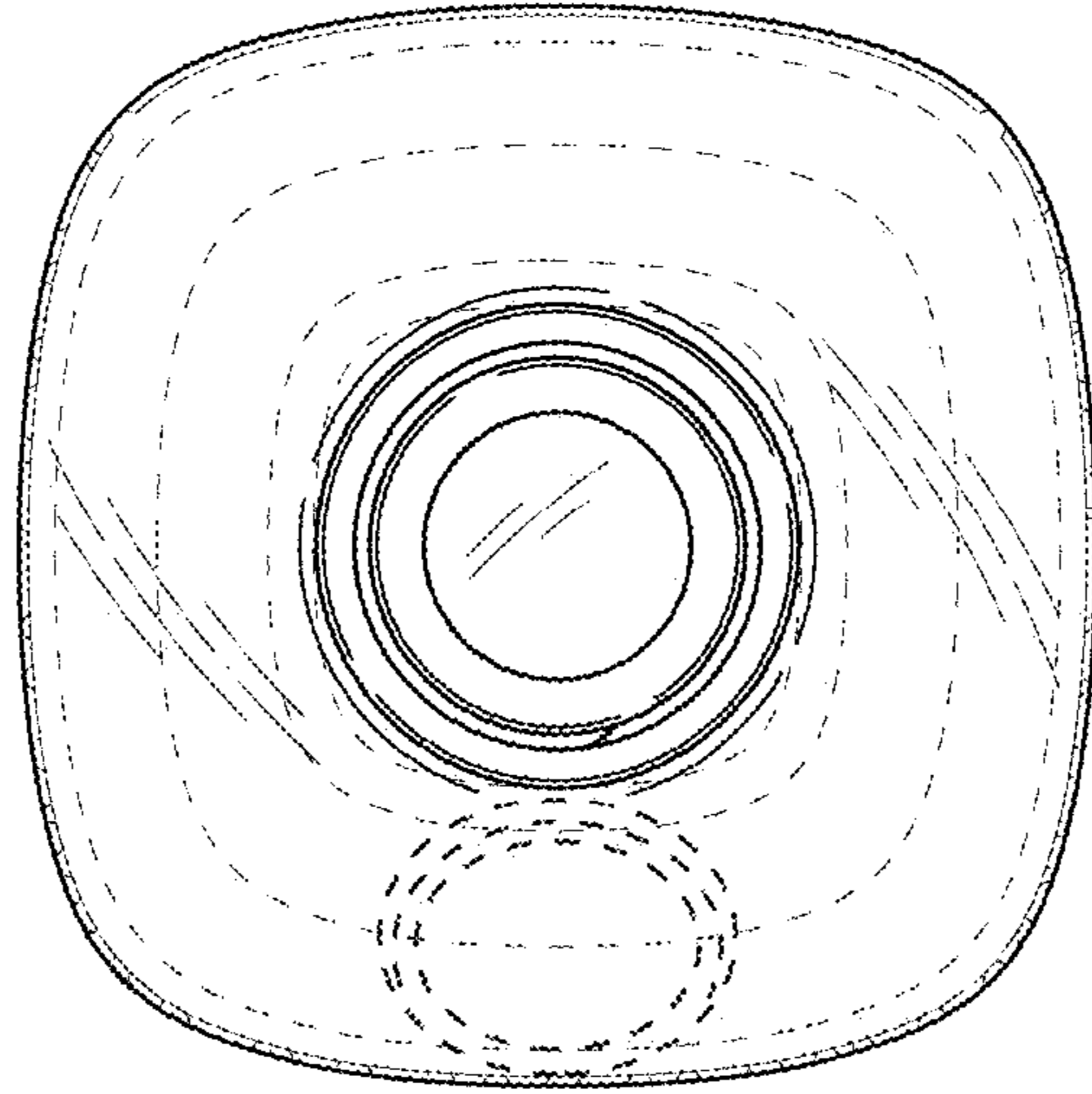

FIG. 14

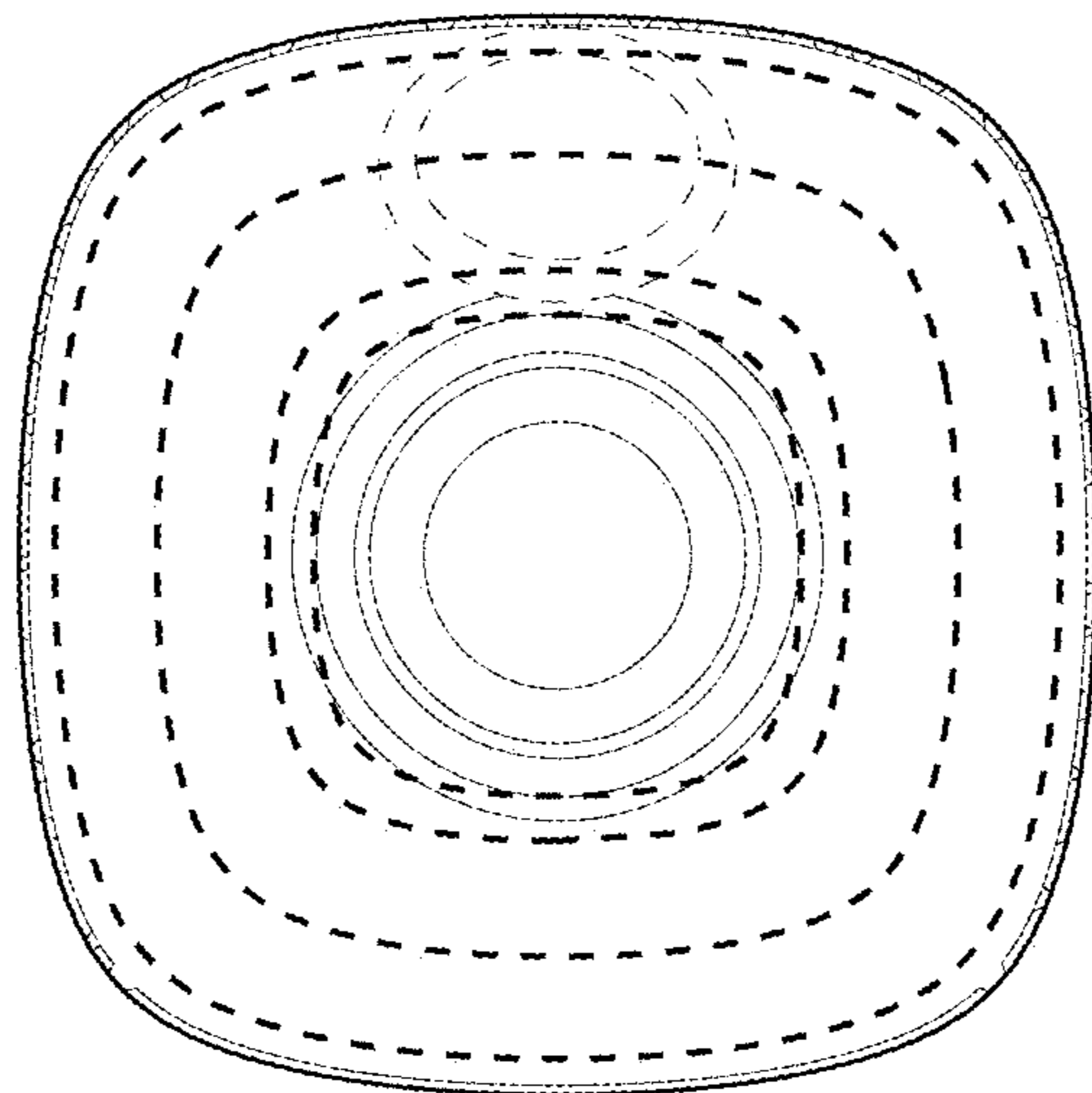

FIG. 15

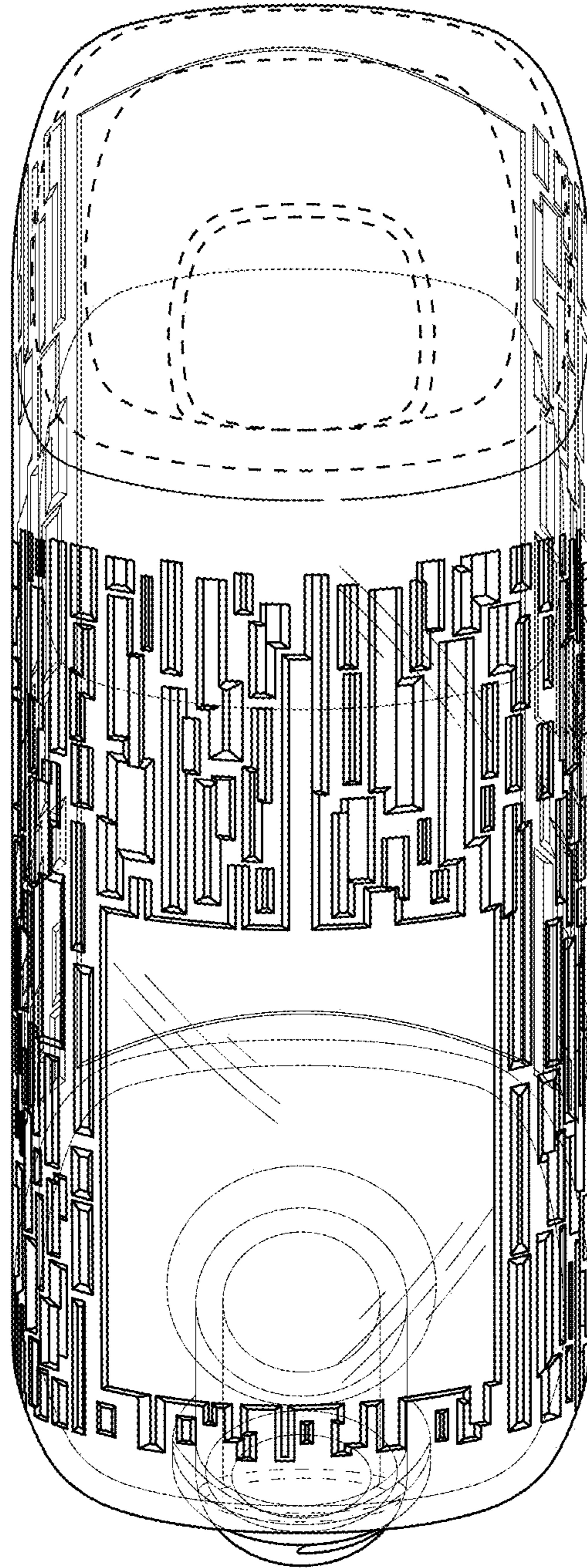

FIG. 16